

Your Global Automation Partner

# TURCK

## Connectivity Catalog



# A Global Leader in Industrial Automation

Turck's sensors, connectivity, network and interface products are built to be the best. As one of the most **prominent** sensor manufacturers **in the world**, we even back our sensors with a **lifetime warranty**. Turck works by bringing **rugged engineering** solutions to your industrial automation applications.

**85,000+**  
SOLUTIONS

**50+**  
YEARS OF INNOVATION

**2,000+**  
EXPERIENCED SALES REPRESENTATIVES

Pioneer in non-contact  
**sensing** technology

Developed innovative **connectivity**  
solutions in response to our sensor customer needs

Recognized need and advanced knowledge of harsh duty  
environments lead to **I/O solutions**

**SUPPORT &  
DEDICATED SERVICE**

**EXTENSIVE WARRANTY**

 **4,000+**  
APPLICATION EXPERTS

RESPOND  
and SOLVE over **1,200** inquiries  
per day

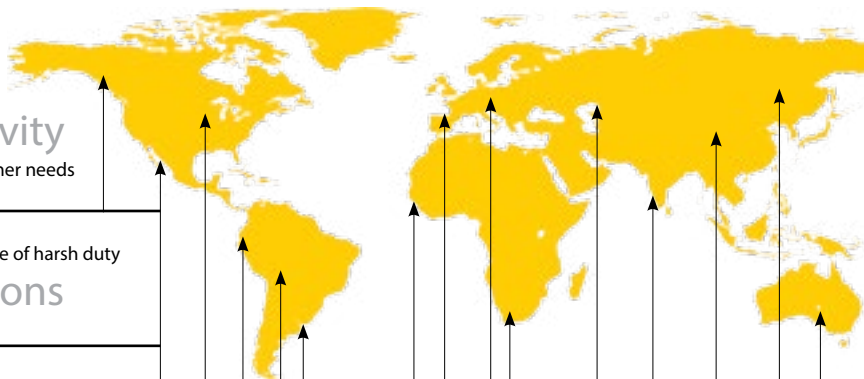

Strategically placed manufacturing facilities in the

USA with **28** GLOBAL  
SUBSIDIARIES

**GLOBAL BUT LOCAL...**

**60** representations worldwide

# TURCK

## THE ADVANTAGE

### ENGINEERED SOLUTIONS

At Turck, we understand that not every application is the same. That's why we dedicate ourselves to finding the optimal engineered solution for every application.

Whether you need a cordset, network I/O, or sensor, our range of innovative manufacturing

capabilities and engineering expertise allows us to achieve what others cannot.

Turck offers advanced designs and the most up to date manufacturing processes – including EDM, molding, and laser trimming – allowing our products to thrive in the harshest environments.

THAT'S THE TURCK ADVANTAGE.

more than

# 13,000

CUSTOM SKUs



### INNOVATIVE MANUFACTURING CAPABILITIES

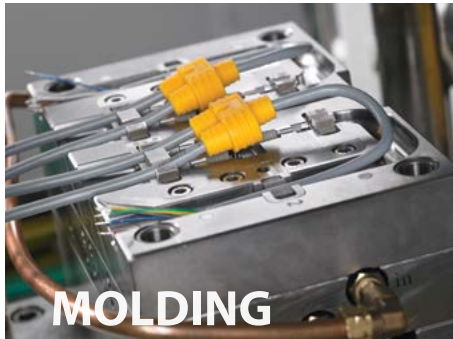

### 10 YEARS EXPERIENCE

providing customers with  
engineered solutions

Just to name a few....

- overmolds
- RFID tags
- kitting
- wiring/pinouts
- pigtails/mold-ons
- color coded wiring
- free software & support
- cable lengths
- daisy chains
- silicone tubing
- extreme environments
- harness assemblies
- mix & match I/O
- major industry protocols
- private labeling
- snap-in labels

and more...

Engineered solutions for all application challenges

# TURCK

## THE GOLD STANDARD

### GREAT VALUE

#### COMPLIMENTARY AUDITS

- At Turck, we consider it our job to help our customers decrease failures and reduce operation downtime. That's why we offer a complimentary audit program. The audit helps you identify, evaluate, and solve problem areas where sensors and cordsets

are continually damaged or destroyed. This reduction in downtime will save you costs, ensuring you get the most out of your production processes.

#### WARRANTY

- We have confidence in our products, and believe you should too. All of our products come with extensive warranties to assure you that our products are not only built to

work, but built to last. We also have 3,500+ application experts ready to support you with any application issues that may arise.

#### Quality

#### MATERIALS

built to last in the harshest environments

- stainless steel
- nickel plated brass
- viton
- rubber
- gold
- PUR/TPU/TPE
- armored cable
- washdown
- extreme temperatures and more...



#### Ship 1 to 1 Million with NO MINIMUM

We understand that not everyone needs 1,000 or one million parts. We offer flexible minimum orders to ensure you get exactly the number of parts you need.

Our products undergo

#### EXTENSIVE TESTING

To continuously deliver solutions of only the highest quality, we put our products through a rigorous set of tests. These tests are in accordance with national and international standards such as IEC and UL to confirm that they meet and exceed industry standards, ensuring their survivability and dependability in all applications.



Point of Use

#### INVENTORY

Get immediate access to Turck products with your own on-site Turck vending machine. Convenient access can help you save money while reducing downtime by having your products easily accessible at a moment's notice.

|                                      |          |
|--------------------------------------|----------|
| <b>M8 Picofast®</b>                  | <b>C</b> |
| <b>M12 Eurofast®</b>                 | <b>D</b> |
| <b>1/2-20 Microfast®</b>             | <b>E</b> |
| <b>7/8", 1" and 1 1/8" Minifast®</b> | <b>F</b> |
| <b>M16 Versafast®</b>                | <b>G</b> |
| <b>M23 and M27 Multifast®</b>        | <b>H</b> |
| <b>Powerfast</b>                     | <b>J</b> |
| <b>Ethernet</b>                      | <b>K</b> |
| <b>PROFINET</b>                      | <b>L</b> |
| <b>DeviceNet™</b>                    | <b>M</b> |
| <b>FOUNDATION™ fieldbus</b>          | <b>N</b> |
| <b>PROFIBUS® -DP/PA</b>              | <b>P</b> |
| <b>AS-interface®</b>                 | <b>R</b> |
| <b>Junction Box (Multibox®)</b>      | <b>S</b> |
| <b>Valve Plugs</b>                   | <b>T</b> |
| <b>Accessories</b>                   | <b>U</b> |
| <b>Splitters</b>                     | <b>V</b> |
| <b>Reference</b>                     | <b>W</b> |
| <b>Index</b>                         | <b>Y</b> |





|                         |            |
|-------------------------|------------|
| <b>Part Number Keys</b> | <b>C2</b>  |
| <b>Cordsets</b>         | <b>C4</b>  |
| <b>Receptacles</b>      | <b>C16</b> |
| <b>Field Wireables</b>  | <b>C24</b> |
| <b>Inserts</b>          | <b>C28</b> |
| <b>Closure Caps</b>     | <b>C31</b> |

## Features

- 3, 4 and 6 pins
- Threaded or snap mating
- Nickel-brass or stainless steel materials
- Straight and angled connectors
- LED options
- Receptacles with leads or PCB pins



## Cordset Part Number Key

Part Number Keys are to assist in IDENTIFICATION ONLY. Consult factory for catalog items not identified.

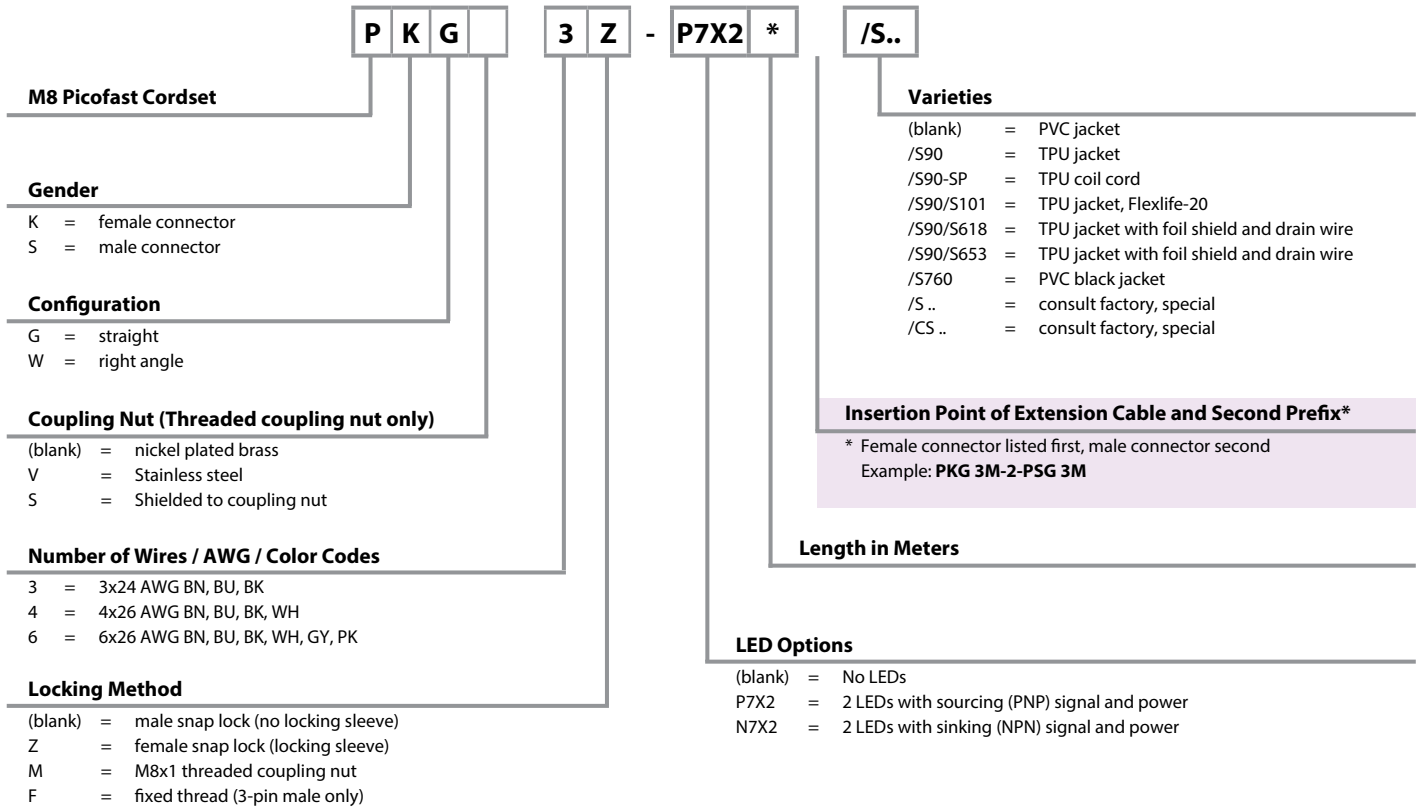

### Extension Examples:

Hybrid connector extensions also available. Consult factory.

### Extension Examples:

Hybrid connector extensions also available. Consult factory.

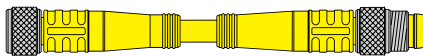

PKG 3M - 2 - PSG 3M

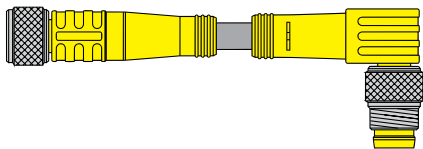

PKG 3M - 2 - PSW 3M

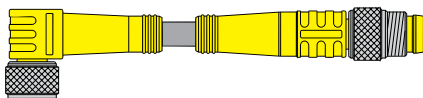

PKW 3M - 2 - PSG 3M

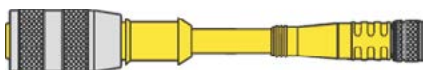

RK 4.4 T - 2 - PKG 4M



Receptacle Part Number Key

Part Number Keys are to assist in IDENTIFICATION ONLY. Consult factory for catalog items not identified.

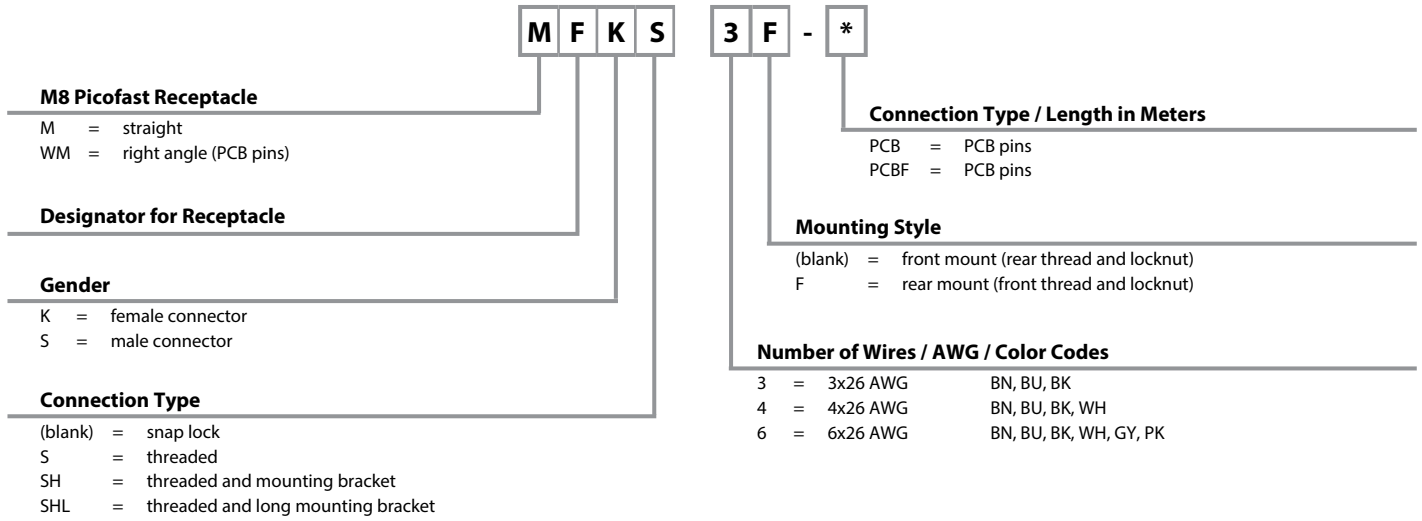

picofast®

Field Wireable Part Number Key

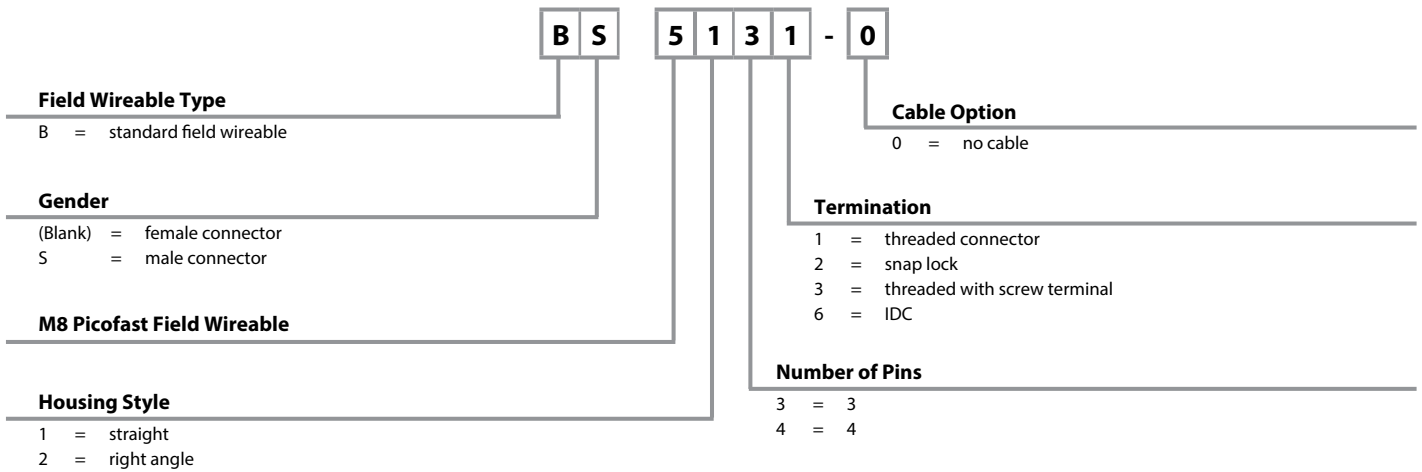

## 3-Wire Cordsets, Snap Lock (Locking Sleeve)

- NEMA 1, 3, 4, 6P
- IEC IP67 Protection
- 125 V, 4 A



| Connector Style         | Female Part Number                                   | Male Part Number                                   | Features  | Pinout                                  |
|-------------------------|--|--|---|---|
| <p><b>PKG ..Z**</b></p> | <b>PKG 3Z-*</b><br><b>PKW 3Z-*</b>                   | <b>PSG 3-*</b><br><b>PSW 3-*</b>                   | AWM, PVC Yellow, 3x24 AWG, 105 °C, 4.4 mm OD, Cable #RF50642-*M, Flexlife®  | <p><b>Female</b></p> <p><b>Male</b></p> |
| <p><b>PKW ..Z**</b></p> | <b>PKG 3Z-*/S90</b><br><b>PKW 3Z-*/S90</b>           | <b>PSG 3-*/S90</b><br><b>PSW 3-*/S90</b>           | AWM, TPU Black, 3x24 AWG, 90 °C, 4.2 mm OD, Cable #RF50587-*M, Cut/Abrasion Immune  |   |
| <p><b>PSG ..</b></p>    | <b>PKG 3Z-*/S90/S101</b><br><b>PKW 3Z-*/S90/S101</b> | <b>PSG 3-*/S90/S101</b><br><b>PSW 3-*/S90/S101</b> | AWM, TPU Black, 3x24 AWG, 90 °C, 4.4 mm OD, Cable #RF51166-*M, Cut/Abrasion Immune, Flexlife-20, High Flex - Over 20 Million Cycles |   |
| <p><b>PSW ..</b></p>    | <b>PKG 3Z-*/S90/S618</b><br><b>PKW 3Z-*/S90/S618</b> | <b>PSG 3-*/S90/S618</b><br><b>PSW 3-*/S90/S618</b> | AWM, TPU Black, 3x24 AWG, 90 °C, 4.2 mm OD, Cable #RF50601-*M, Cut/Abrasion Immune, EMI/RFI Protection                              |   |
|                         | <b>PKG 3Z-*/S760</b><br><b>PKW 3Z-*/S760</b>         | <b>PSG 3-*/S760</b><br><b>PSW 3-*/S760</b>         | AWM, PVC Black, 3x24 AWG, 105 °C, 4.2 mm OD, Cable #RF50585-M, Flexlife   |   |

\* Length in meters. Standard cable lengths are 2, 4, 5, 6, 8 and 10 meters.  
 \*\* Locking sleeve material is POM. "PKG..Z".

We reserve the right to make technical alterations without prior notice.

## 4-Wire Cordsets, Snap Lock (Locking Sleeve)

- NEMA 1, 3, 4, 6P
- IEC IP67 Protection
- 125 V, 2 A



Cordsets

| Connector Style         | Female Part Number                                   | Male Part Number                                   | Features  | Pinout                              |
|-------------------------|--|--|---|-------------------------------------|
| <p><b>PKG ..Z**</b></p> | <b>PKG 4Z-*</b><br><b>PKW 4Z-*</b>                   | <b>PSG 4-*</b><br><b>PSW 4-*</b>                   | AWM, PVC Yellow, 4x26 AWG, 105 °C, 4.4 mm OD, Cable #RF50697-*M, Flexlife®  |                                     |
|                         | <b>PKG 4Z-*/S90</b><br><b>PKW 4Z-*/S90</b>           | <b>PSG 4-*/S90</b><br><b>PSW 4-*/S90</b>           | AWM, TPU Black, 4x26 AWG, 90 °C, 4.2 mm OD, Cable #RF50586-*M, Cut/Abrasion Immune  | <p><b>Female</b></p>                |
| <p><b>PKW ..Z**</b></p> | <b>PKG 4Z-*/S90/S101</b><br><b>PKW 4Z-*/S90/S101</b> | <b>PSG 4-*/S90/S101</b><br><b>PSW 4-*/S90/S101</b> | AWM, TPU Black, 4x26 AWG, 90 °C, 4.4 mm OD, Cable #RF50935-*M, Cut/Abrasion Immune, Flexlife-20, High Flex - Over 20 Million Cycles | 1. BN<br>2. WH<br>3. BU<br>4. BK    |
| <p><b>PSG ..</b></p>    | <b>PKG 4Z-*/S90/S618</b><br><b>PKW 4Z-*/S90/S618</b> | <b>PSG 4-*/S90/S101</b><br><b>PSW 4-*/S90/S101</b> | AWM, TPU Black, 4x26 AWG, 90 °C, 4.2 mm OD, Cable #RF50602-*M, Cut/Abrasion Immune, EMI/RFI Protection                              |                                     |
|                         | <b>PKG 4Z-*/S760</b><br><b>PKW 4Z-*/S760</b>         | <b>PSG 4-*/S760</b><br><b>PSW 4-*/S760</b>         | AWM, PVC Black, 4x26 AWG, 105 °C, 4.4 mm OD, Cable #RF50870-*M, Flexlife  | <p><b>Male</b></p>                  |
| <p><b>PSW ..</b></p>    | <b>PKG 4Z-*/S90/S653</b><br><b>PKW 4Z-*/S90/S653</b> | <b>PSG 4-*/S90/S653</b><br><b>PSW 4-*/S90/S653</b> | AWM, TPU Black, 3x24 AWG, 90 °C, 4.2 mm OD, Cable #RF50601-*M, Cut/Abrasion Immune, EMI/RFI Protection                              | 1. BN<br>2. Drain<br>3. BU<br>4. BK |

\* Length in meters. Standard cable lengths are 2, 4, 5, 6, 8 and 10 meters.

\*\* Locking sleeve material is POM.. "PKG..Z".

We reserve the right to make technical alterations without prior notice.

## 6-Wire Cordsets, Snap Lock (Locking Sleeve)

- NEMA 1, 3, 4, 6P
- IEC IP67 Protection
- 125 V, 2 A



| Connector Style  | Female Part Number                                   | Male Part Number                                   | Features   | Pinout   |
|--|--|--|--|--|
| <p>PKG ..Z**</p> <p>1.260 [32.0]</p> <p>0.404 [10.2]</p> <p>LOCKING SLEEVE</p> | <b>PKG 6Z-*</b><br><b>PKW 6Z-*</b>                   | <b>PSG 6-*</b><br><b>PSW 6-*</b>                   | AWM, PVC Yellow, 6x26 AWG, 105 °C, 4.5 mm OD, Cable #RF50734-*M, Flexlife®, UL Listed                | <p><b>Female</b></p> <p>1. BN<br/>2. WH<br/>3. BU<br/>4. BK<br/>5. GY<br/>6. PK</p> <p><b>Male</b></p> |
| <p>PKW ..Z**</p> <p>LOCKING SLEEVE</p> <p>0.665 [16.9]</p> <p>1.140 [29.0]</p> | <b>PKG 6Z-*/S90</b><br><b>PKW 6Z-*/S90</b>           | <b>PSG 6-*/S90</b><br><b>PSW 6-*/S90</b>           | AWM, TPU Black, 6x26 AWG, 90 °C, 4.2 mm OD, Cable #RF50735-*M, Cut/Abrasion Immune                   |  |
| <p>PSG ..</p> <p>1.228 [31.2]</p> <p>0.331 [8.4]</p>                           | <b>PKG 6Z-*/S90/S618</b><br><b>PKW 6Z-*/S90/S618</b> | <b>PSG 6-*/S90/S618</b><br><b>PSW 6-*/S90/S618</b> | AWM, TPU Black, 6x26 AWG, 90 °C, 4.2 mm OD, Cable #RF51144-M, Cut/Abrasion Immune EMI/RFI Protection |  |
| <p>PSW ..</p> <p>1.089 [27.6]</p> <p>0.720 [18.3]</p> <p>0.327 [8.3]</p>       | <b>PKG 6Z-*/S760</b><br><b>PKW 6Z-*/S760</b>         | <b>PSG 6-*/S760</b><br><b>PSW 6-*/S760</b>         | AWM, PVC Black, 6x26 AWG, 105 °C, 4.5 mm OD, Cable #RF51083-*M, Flexlife®, UL Listed                 |  |

\* Length in meters. Standard cable lengths are 2, 4, 5, 6, 8 and 10 meters.

\*\* Locking sleeve material is POM.. "PKG..Z".

We reserve the right to make technical alterations without prior notice.

## 3-Wire Cordsets, Threaded Coupling Nut

- NEMA 1, 3, 4, 6P
- IEC IP67 Protection
- 125 V, 4 A



| Connector Style           | Female Part Number                                     | Male Part Number                                       | Features  | Pinout   |
|---------------------------|--|--|---|--|
| <p><b>PKG ..Z**</b></p>   | <b>PKG 3M-*</b><br><b>PKW 3M-*</b>                     | <b>PSG 3M-*</b><br><b>PSW 3M-*</b>                     | AWM, PVC Yellow, 3x24 AWG, 105 °C, 4.4 mm OD, Cable #RF50642-*M, Flexlife®  | <p><b>Female</b></p> <p>1. BN<br/>3. BU<br/>4. BK</p>  |
| <p><b>PKW ..M**</b></p>   | <b>PKG 3M-*/S90</b><br><b>PKW 3M-*/S90</b>             | <b>PSG 3M-*/S90</b><br><b>PSW 3M-*/S90</b>             | AWM, TPU Black, 3x24 AWG, 90 °C, 4.2 mm OD, Cable #RF50587-*M, Cut/Abrasion Immune  |  |
| <p><b>PSG ..M**</b></p>   | <b>PKG 3M-*/S90/S101</b><br><b>PKW 3M-*/S90/S101</b>   | <b>PSG 3M-*/S90/S101</b><br><b>PSW 3M-*/S90/S101</b>   | AWM, TPU Black, 3x24 AWG, 90 °C, 4.4 mm OD, Cable #RF51166-*M, Cut/Abrasion Immune, Flexlife-20, High Flex - Over 20 Million Cycles |  |
| <p><b>PSW ..M**</b></p>   | <b>PKG 3M-*/S90/S618</b><br><b>PKW 3M-*/S90/S618</b>   | <b>PSG 3M-*/S90/S618</b><br><b>PSW 3M-*/S90/S618</b>   | AWM, TPU Black, 3x24 AWG, 90 °C, 4.2 mm OD, Cable #RF50601-*M, Cut/Abrasion Immune, EMI/RFI Protection                              | <p><b>Male</b></p> <p>1. BN<br/>3. BU<br/>4. Drain</p> |
| <p><b>PKW ..M**</b></p>   | <b>PKG 3M-*/S1587</b><br><b>PKW 3M-*/S1587</b>         | <b>PSG 3M-*/S1587</b><br><b>PSW 3M-*/S1587</b>         | AWM, TPE Yellow, 3x24 AWG, 105 °C, 4.4 mm OD, Cable #RF51271-*M, Weldlife®, Weld Flash Immune                                       |  |
| <p><b>PSG ..M**</b></p>   | <b>PKG 3M-*/S760</b><br><b>PKW 3M-*/S760</b>           | <b>PSG 3M-*/S760</b><br><b>PSW 3M-*/S760</b>           | AWM, PVC Black, 3x24 AWG, 4.2 mm OD, Cable #RF50585-M, Flexlife   |  |
| <p><b>PSW ..M**</b></p>   | <b>PKG 3M-*/S90/S1084</b><br><b>PKW 3M-*/S90/S1084</b> | <b>PSG 3M-*/S90/S1084</b><br><b>PSW 3M-*/S90/S1084</b> | AWM, TPU Black, 2x24 AWG, 90 °C, 4.2 mm OD, Cable #RF51197-*M, Cut/Abrasion Immune, Shielded  | <p>1. BN<br/>3. BU<br/>4. BK</p>                       |
| <p><b>PSG 3F ..**</b></p> |  | <b>PSG 3F-*</b>  | AWM, PVC Yellow, 3x24 AWG, 105 °C, 4.4 mm OD, Cable #RF50642-*M, Fixed coupling nut   |  |

\* Length in meters. Standard cable lengths are 2, 4, 5, 6, 8 and 10 meters.

\*\* Standard coupling material is nickel plated brass..\*PKG..M\*; \*PKG.V..M\* indicates stainless steel.

We reserve the right to make technical alterations without prior notice.

Cordsets

## 4-Wire Cordsets, Threaded Coupling Nut

- NEMA 1, 3, 4, 6P
- IEC IP67 Protection
- 125 V, 4 A



| Connector Style         | Female Part Number                                   | Male Part Number                                     | Features   | Pinout                                     |
|-------------------------|--|--|--|--|
| <p><b>PKG ..M**</b></p> | <b>PKG 4M-*</b><br><b>PKW 4M-*</b>                   | <b>PSG 4M-*</b><br><b>PSW 4M-*</b>                   | AWM PVC Yellow, 4x26 AWG, 105 °C, 4.4 mm OD, Cable #RF50697-*M, Flexlife®  |  |
| <p><b>PKW ..M**</b></p> | <b>PKG 4M-*/S90</b><br><b>PKW 4M-*/S90</b>           | <b>PSG 4M-*/S90</b><br><b>PSW 4M-*/S90</b>           | AWM TPU Black, 4x26 AWG, 90 °C, 4.2 mm OD, Cable #RF50586-*M, Cut/Abrasion Immune  | <p><b>Female</b></p>                       |
| <p><b>PKG ..M**</b></p> | <b>PKG 4M-*/S90/S101</b><br><b>PKW 4M-*/S90/S101</b> | <b>PSG 4M-*/S90/S101</b><br><b>PSW 4M-*/S90/S101</b> | AWM TPU Black, 4x26 AWG, 90 °C, 4.4 mm OD, Cable #RF50935-*M, Cut/Abrasion Immune, Flexlife-20, High Flex - Over 20 Million Cycles |  |
| <p><b>PSG ..M**</b></p> | <b>PKG 4M-*/S90/S618</b><br><b>PKW 4M-*/S90/S618</b> | <b>PSG 4M-*/S90/S618</b><br><b>PSW 4M-*/S90/S618</b> | AWM TPU Black, 4x26 AWG, 90 °C, 4.2 mm OD, Cable #RF50602-*M, Cut/Abrasion Immune, EMI/RFI Protection                              | <p>1. BN<br/>2. WH<br/>3. BU<br/>4. BK</p> |
| <p><b>PSW ..M**</b></p> | <b>PKG 4M-*/S760</b><br><b>PKW 4M-*/S760</b>         | <b>PSG 4M-*/S760</b><br><b>PSW 4M-*/S760</b>         | AWM PVC Black, 4x26 AWG, 105 °C, 4.4 mm OD, Cable #RF50870-*M, Flexlife  | <p><b>Male</b></p>                         |
|                         | <b>PKG 4M-*/S90/S653</b><br><b>PKW 4M-*/S90/S653</b> | <b>PSG 4M-*/S90/S653</b><br><b>PSW 4M-*/S90/S653</b> | AWM TPU Black, 3x24 AWG, 90 °C, 4.2 mm OD, Cable #RF50601-*M, Cut/Abrasion Immune, EMI/RFI Protection                              |  |

We reserve the right to make technical alterations without prior notice.

\* Length in meters. Standard cable lengths are 2, 4, 5, 6, 8 and 10 meters.  
 \*\* Standard coupling material is nickel plated brass. "PKG..M"; "PKG..M" indicates stainless steel.

## 6-Wire Cordsets, Threaded Coupling Nut

- NEMA 1, 3, 4, 6P
- IEC IP67 Protection
- 125 V, 2 A



We reserve the right to make technical alterations without prior notice.

| Connector Style         | Female Part Number                                   | Male Part Number                                     | Features   | Pinout   |
|-------------------------|--|--|--|--|
| <p><b>PKG ..M**</b></p> | <b>PKG 6M-*</b><br><b>PKW 6M-*</b>                   | <b>PSG 6M-*</b><br><b>PSW 6M-*</b>                   | AWM PVC Yellow, 6x26 AWG, 105 °C, 4.5 mm OD, Cable #RF50734-*M, Flexlife®, UL Listed                 | <p><b>Female</b></p> <p>1. BN<br/>2. WH<br/>3. BU<br/>4. BK<br/>5. GY<br/>6. PK</p> <p><b>Male</b></p> |
| <p><b>PKW ..M**</b></p> | <b>PKG 6M-*/S90</b><br><b>PKW 6M-*/S90</b>           | <b>PSG 6M-*/S90</b><br><b>PSW 6M-*/S90</b>           | AWM TPU Black, 6x26 AWG, 90 °C, 4.2 mm OD, Cable #RF50735-*M, Cut/Abrasion Immune                    |  |
| <p><b>PSG ..M**</b></p> | <b>PKG 6M-*/S760</b><br><b>PKW 6M-*/S760</b>         | <b>PSG 6M-*/S760</b><br><b>PSW 6M-*/S760</b>         | AWM PVC Black, 6x26 AWG, 105 °C, 4.5 mm OD, Cable #RF51083-*M, Flexlife, UL Listed                   |  |
| <p><b>PSW ..M**</b></p> | <b>PKG 6M-*/S90/S618</b><br><b>PKW 6M-*/S90/S618</b> | <b>PSG 6M-*/S90/S618</b><br><b>PSW 6M-*/S90/S618</b> | AWM TPU Black, 6x26 AWG, 90 °C, 4.2 mm OD, Cable #RF51144-*M, Cut/Abrasion Immune EMI/RFI Protection |  |

\* Length in meters. Standard cable lengths are 2, 4, 5, 6, 8 and 10 meters.

\*\* Standard coupling material is nickel plated brass..\*PKG..M\*"; \*PKG..M" indicates stainless steel.

Cordsets

## 3 and 4-Wire Cordsets, Threaded Coupling Nut, Shielded

- Shield to Coupling Nut
- IEC IP67 Protection
- 125 V, 4 A (3-pin), 2 A (4-pin)



| Connector Style         | Female Part Number                                   | Male Part Number                                     | Features   | Pinout  |
|-------------------------|--|--|--|---|
| <p><b>PKG ..M**</b></p> | <p><b>PKGS 3M-*</b><br/><b>PKWS 3M-*</b></p>         | <p><b>PSGS 3M-*</b><br/><b>PSWS 3M-*</b></p>         | <p>AWM, PVC Yellow, 3x24 AWG, 105 °C, 5.1 mm OD, Cable #RF51422-*M, RFI/EMI Shielding Tied to Coupling Nut</p> | <p><b>Female</b></p> <p>1. BN<br/>3. BU<br/>4. BK</p>           |
| <p><b>PKW ..M**</b></p> | <p><b>PKGS 3M-*/S90</b><br/><b>PKWS 3M-*/S90</b></p> | <p><b>PSGS 3M-*/S90</b><br/><b>PSWS 3M-*/S90</b></p> | <p>AWM, TPU Black, 3x24 AWG, 90 °C, 5.1 mm OD, Cable #RF51423-*M, RFI/EMI Shielding Tied to Coupling Nut</p>   | <p><b>Male</b></p>  |
| <p><b>PSG ..M**</b></p> | <p><b>PKGS 4M-*</b><br/><b>PKWS 4M-*</b></p>         | <p><b>PSGS 4M-*</b><br/><b>PSWS 4M-*</b></p>         | <p>AWM, PVC Yellow, 4x26 AWG, 105 °C, 5.1 mm OD, Cable #RF51424-*M, RFI/EMI Shielding Tied to Coupling Nut</p> | <p><b>Female</b></p> <p>1. BN<br/>2. WH<br/>3. BU<br/>4. BK</p> |
| <p><b>PSW ..M**</b></p> | <p><b>PKGS 4M-*/S90</b><br/><b>PKWS 4M-*/S90</b></p> | <p><b>PSGS 4M-*/S90</b><br/><b>PSWS 4M-*/S90</b></p> | <p>AWM, TPU Black, 4x26 AWG, 90 °C, 5.1 mm OD, Cable #RF51425-*M, RFI/EMI Shielding Tied to Coupling Nut</p>   | <p><b>Male</b></p>  |

We reserve the right to make technical alterations without prior notice.

\* Length in meters. Standard cable lengths are 2, 4, 6, 8 and 10 meters. Consult factory for other lengths.

\*\* Standard coupling material is nickel plated brass.



## 3 and 4-Wire Cordsets, with LEDs, Snap Lock (Locking Sleeve)

- NEMA 1, 3, 4, 6P
- IEC IP67 Protection
- 10-30 VDC, 4 A (3-pin), 2 A (4-pin)



| Connector Style               | Female Part Number   | Features   | Pinout  |
|-------------------------------|--|--|---|
|                               | <b>PKW 3Z-P7X2-*</b>   | AWM PVC Yellow, 3x24 AWG, 105 °C, 4.4 mm OD, Cable #RF50642-*M, PNP Signal, Flexlife®  | <b>Female</b><br><br>1. BN<br>3. BU<br>4. BK        |
|                               | <b>PKW 3Z-P7X2-*/S90</b>   | AWM TPU Black, 3x24 AWG, 90 °C, 4.2 mm OD, Cable #RF50587-*M, PNP Signal, Cut/Abrasion Immune  |   |
|                               | <b>PKW 3Z-P7X2-*/S90/S618</b>  | AWM TPU Black, 3x24 AWG, 90 °C, 4.2 mm OD, Cable #RF50601-*M, PNP Signal, Cut/Abrasion Immune, EMI/RFI Protection                              |   |
|                               | <b>PKW 3Z-P7X2-*/S90/S101</b>  | AWM TPU Black, 3x24 AWG, 90 °C, 4.4 mm OD, Cable #RF51166-*M, PNP Signal, Cut/Abrasion Immune, Flexlife-20, High Flex - over 20 Million Cycles | <b>Female</b><br><br>1. BN<br>3. BU<br>4. BK        |
|                               | <b>PKW 3Z-N7X2-*</b>   | AWM PVC Yellow, 3x24 AWG, 105 °C, 4.4 mm OD, Cable #RF50642-*M, NPN Signal, Flexlife   |   |
|                               | <b>PKW 3Z-N7X2-*/S90</b>   | AWM TPU Black, 3x24 AWG, 90 °C, 4.2 mm OD, Cable #RF50587-*M, NPN Signal, Cut/Abrasion Immune  |   |
|                               | <b>PKW 3Z-N7X2-*/S90/S618</b>  | AWM TPU Black, 3x24 AWG, 90 °C, 4.2 mm OD, Cable #RF50601-*M, NPN Signal, Cut/Abrasion Immune, EMI/RFI Protection                              | <b>Male</b><br><br>1. BN<br>2. WH<br>3. BU<br>4. BK |
|                               | <b>PKW 3Z-N7X2-*/S90/S101</b>  | AWM TPU Black, 3x24 AWG, 90 °C, 4.4 mm OD, Cable #RF51166-*M, NPN Signal, Cut/Abrasion Immune, Flexlife-20, High Flex - over 20 Million Cycles |   |
|                               | <b>PKW 4Z-P7X2-*</b>   | AWM PVC Yellow, 4x26 AWG, 105 °C, 4.4 mm OD, Cable #RF50697-*M, PNP Signal, Flexlife   |   |
| <b>PKW 4Z-P7X2-*/S90</b>      | AWM TPU Black, 4x26 AWG, 90 °C, 4.2 mm OD, Cable #RF50586-*M, PNP Signal, Cut/Abrasion Immune  | <b>Male</b><br><br>1. BN<br>2. WH<br>3. BU<br>4. BK  |   |
| <b>PKW 4Z-P7X2-*/S90/S101</b> | AWM TPU Black, 4x26 AWG, 90 °C, 4.4 mm OD, Cable #RF50935-*M, PNP Signal, Cut/Abrasion Immune, Flexlife-20, High Flex - Over 20 Million Cycles |  |   |

We reserve the right to make technical alterations without prior notice.

\* Length in meters. Standard cable lengths are 2, 4, 6, 8 and 10 meters.

\*\* Locking sleeve material is POM..“PKW..Z”.

Cordsets

## 3 and 4-Wire Cordsets, Threaded Coupling Nut, Shielded

- NEMA 1, 3, 4, 6P
- IEC IP67 Protection
- 10-30 VDC, 4 A



| Connector Style | Female Part Number            | Male Part Number              | Features   | Pinout   |
|-----------------|-------------------------------|-------------------------------|--|--|
|                 | <b>PKW 3M-P7X2-*</b>          | <b>PSW 3M-P7X2-*</b>          | AWM PVC Yellow, 3x24 AWG, 105 °C, 4.4 mm OD, Cable #RF50642- <i>M</i> , PNP Signal, Flexlife®  | <p style="text-align: center;"><b>Female</b></p> |
|                 | <b>PKW 3M-P7X2-*/S90</b>      | <b>PSW 3M-P7X2-*/S90</b>      | AWM TPU Black, 3x24 AWG, 90 °C, 4.2 mm OD, Cable #RF50587- <i>M</i> , PNP Signal, Cut/Abrasion Immune  |  |
|                 | <b>PKW 3M-P7X2-*/S90/S101</b> | <b>PSW 3M-P7X2-*/S90/S101</b> | AWM TPU Black, 3x24 AWG, 90 °C, 4.4 mm OD, Cable #RF51166- <i>M</i> , PNP Signal, Cut/Abrasion Immune, Flexlife-20, High Flex - over 20 Million Cycles |  |
|                 | <b>PKW 3M-P7X2-*/S90/S618</b> |                               | AWM TPU Black, 3x24 AWG, 90 °C, 4.2 mm OD, Cable #RF50601- <i>M</i> , PNP Signal, Cut/Abrasion Immune, EMI/RFI Protection                              |  |
|                 | <b>PKW 3M-N7X2-*</b>          |                               | AWM PVC Yellow, 3x24 AWG, 105 °C, 4.4 mm OD, Cable #RF50642- <i>M</i> , NPN Signal, Flexlife   |  |
|                 | <b>PKW 3M-N7X2-*/S90</b>      |                               | AWM TPU Black, 3x24 AWG, 90 °C, 4.2 mm OD, Cable #RF50587- <i>M</i> , NPN Signal, Cut/Abrasion Immune  |  |
|                 | <b>PKW 3M-N7X2-*/S90/S101</b> |                               | AWM TPU Black, 3x24 AWG, 90 °C, 4.4 mm OD, Cable #RF51166- <i>M</i> , NPN Signal, Cut/Abrasion Immune, Flexlife-20, High Flex - over 20 Million Cycles |  |
|                 | <b>PKW 3M-N7X2-*/S90/S618</b> |                               | AWM TPU Black, 3x24 AWG, 90 °C, 4.2 mm OD, Cable #RF50601- <i>M</i> , NPN Signal, Cut/Abrasion Immune, EMI/RFI Protection                              |  |

We reserve the right to make technical alterations without prior notice.

\* Length in meters. Standard cable lengths are 2, 4, 6, 8 and 10 meters. Consult factory for other lengths.

\*\* Standard coupling material is nickel plated brass.

4-Wire Cordsets, with LEDs, Threaded Coupling Nut

- NEMA 1, 3, 4, 6P
- IEC IP67 Protection
- 10-30 VDC, 2 A



| Connector Style | Female Part Number            | Features   | Pinout  |
|-----------------|-------------------------------|--|---|
|                 | <b>PKW 4M-P7X2-*</b>          | AWM PVC Yellow, 4x26 AWG, 105 °C, 4.4 mm OD, Cable #RF50697-*M, PNP Signal, Flexlife®  | <p><b>Female</b></p> <p>1. BN<br/>2. WH<br/>3. BU<br/>4. BK</p> |
|                 | <b>PKW 4M-P7X2-*/S90</b>      | AWM TPU Black, 4x26 AWG, 90 °C, 4.2 mm OD, Cable #RF50586-*M, PNP Signal, Cut/Abrasion Immune  |   |
|                 | <b>PKW 4M-P7X2-*/S90/S101</b> | AWM TPU Black, 4x26 AWG, 90 °C, 4.4 mm OD, Cable #RF50935-*M, PNP Signal, Cut/Abrasion Immune, Flexlife-20, High Flex - over 20 Million Cycles |   |
|                 | <b>PKW 4M-P7X2-*/S90/S618</b> | AWM TPU Black, 4x26 AWG, 90 °C, 4.2 mm OD, Cable #RF50602-*M, PNP Signal, Cut/Abrasion Immune, EMI/RFI Protection                              |   |

\* Length in meters. Standard cable lengths are 2, 4, 6, 8 and 10 meters.  
 \*\* Locking sleeve material is POM.. "PKW..Z".

We reserve the right to make technical alterations without prior notice.

Cordsets

## 3 and 4-Wire Spiral Cordsets, Snap Lock (Locking Sleeve)

- NEMA 1, 3, 4, 6P
- IEC IP67 Protection
- 125 V, 4 A (3-pin) and 2 A (4-pin)



| Connector Style         | Female Part Number                               | Male Part Number                               | Features   | Pinout               |
|-------------------------|--|--|--|----------------------|
| <p><b>PKG ..Z**</b></p> | <b>PKG 3Z-3/S90-SP</b><br><b>PKW 3Z-3/S90-SP</b> | <b>PSG 3-3/S90-SP</b><br><b>PSW 3-3/S90-SP</b> | AWM TPU Black, 4x26<br>AWG, 90 °C, 125 VAC/<br>VDC, 4 A, 4.2 mm OD, for<br>repetitive motion 3-wire<br>applications, snap lock<br>coupling nut | <p><b>Female</b></p> |
| <p><b>PKW ..Z**</b></p> |  |  |  | <p><b>Male</b></p>   |
| <p><b>PSG ..</b></p>    | <b>PKG 4Z-3/S90-SP</b><br><b>PKW 4Z-3/S90-SP</b> | <b>PSG 4-3/S90-SP</b><br><b>PSW 4-3/S90-SP</b> | AWM TPU Black, 4x26<br>AWG, 90 °C, 125 VAC/<br>VDC, 2 A, 4.2 mm OD, for<br>repetitive motion 4-wire<br>applications, snap lock<br>coupling nut | <p><b>Female</b></p> |
| <p><b>PSW ..</b></p>    |  |  |  | <p><b>Male</b></p>   |

We reserve the right to make technical alterations without prior notice.

\* Length in meters. Standard cable length is 3 meters. Consult factory for other lengths.

\*\* Locking sleeve material is POM.. "PKG(W)..Z".

## 3 and 4-Wire Spiral Cordsets, Threaded Coupling Nut

- NEMA 1, 3, 4, 6P
- IEC IP67 Protection
- 125 VAC/VDC, 4 A (3-pin) and 2 A (4-pin)





| Connector Style         | Female Part Number                               | Male Part Number                                 | Features  | Pinout                                  |
|-------------------------|--|--|---|---|
| <p><b>PKG ..Z**</b></p> | <b>PKG 3M-3/S90-SP</b><br><b>PKW 3M-3/S90-SP</b> | <b>PSG 3M-3/S90-SP</b><br><b>PSW 3M-3/S90-SP</b> | AWM TPU Black, 4x26 AWG, 90 °C, 125 VAC/VDC, 4 A, 4.2 mm OD, for repetitive motion 3-wire applications, threaded coupling nut | <p><b>Female</b></p> <p><b>Male</b></p> |
| <p><b>PKW ..Z**</b></p> |  |  |   |   |
| <p><b>PSG ..</b></p>    | <b>PKG 4M-3/S90-SP</b><br><b>PKW 4M-3/S90-SP</b> | <b>PSG 4M-3/S90-SP</b><br><b>PSW 4M-3/S90-SP</b> | AWM TPU Black, 4x26 AWG, 90 °C, 125 VAC/VDC, 2 A, 4.2 mm OD, for repetitive motion 4-wire applications, threaded coupling nut | <p><b>Female</b></p> <p><b>Male</b></p> |
| <p><b>PSW ..</b></p>    |  |  |   |   |

We reserve the right to make technical alterations without prior notice.

\* Length in meters. Standard cable length is 3 meters. Consult factory for other lengths.  
 \*\* Locking sleeve material is POM.. "PKW..Z".

Cordsets

| Mounting Style | Image   | Panel Thread Types   | Page                                   |
|----------------|---|--|--|
| Front Mount    |    | <u>M8</u>  | <u>C17</u>                             |
| Rear Mount     |   | <u>M8</u><br><u>7/16-20 with Solder Cups</u>   | <u>C18</u><br><u>C22</u>               |
| PCB Mount      |  | <u>M8 with PCB Pins</u><br><u>7/16-20 with Header Pins</u><br><u>M8 with Header Pins</u> | <u>C19</u><br><u>C19</u><br><u>C20</u> |

We reserve the right to make technical alterations without prior notice.

## 3, 4 and 6-Wire Receptacles, Front Mount

- NEMA 1, 3, 4, 6P
- IEC IP67 Protection



We reserve the right to make technical alterations without prior notice.

| Housing Style  | Female Part Number | Male Part Number | Features  | Pinout   |
|--|--------------------|------------------|---|--|
| <p><b>MFKS 3..</b></p> <p>Typical panel cutout is 8.2 mm</p> | <b>MFKS 3-*</b>    |                  | 3x24 AWG, 105 °C, 125 V, 4 A, mates with 3-pin threaded female cordsets | <p><b>Female</b></p> <p>1. BN<br/>3. BU<br/>4. BK</p> <p><b>Male</b></p>                               |
|  |                    | <b>MFS 3-*</b>   |   | 3x24 AWG, 105 °C, 125 V, 4 A, mates with 3-pin snap lock female cordsets                               |
| <p><b>MFKS 4..</b></p> <p>Typical panel cutout is 8.2 mm</p> | <b>MFKS 4-*</b>    |                  | 4x24 AWG, 105 °C, 125 V, 4 A, mates with 4-pin threaded female cordsets | <p><b>Female</b></p> <p>1. BN<br/>2. WH<br/>3. BU<br/>4. BK</p> <p><b>Male</b></p>                     |
|  |                    | <b>MFS 4-*</b>   |   | 4x24 AWG, 105 °C, 125 V, 4 A, mates with 4-pin snap lock female cordsets                               |
| <p><b>MFKS 6..</b></p> <p>Typical panel cutout is 8.2 mm</p> | <b>MFKS 6-*</b>    |                  | 6x24 AWG, 105 °C, 125 V, 2 A, mates with 6-pin threaded female cordsets | <p><b>Female</b></p> <p>1. BN<br/>2. WH<br/>3. BU<br/>4. BK<br/>5. GY<br/>6. PK</p> <p><b>Male</b></p> |
|  |                    | <b>MFS 6-*</b>   |   | 6x24 AWG, 105 °C, 125 V, 2 A, mates with 6-pin snap lock female cordsets                               |

\* Length in meters. Standard lead length is 0.2 meters. Consult factory for other lengths. Standard housing material is nickel plated brass .. "MFK(S).."; "MFK(S)V.." indicates stainless steel.

Receptacles

## 3, 4 and 6-Wire Receptacles, Rear Mount

- NEMA 1, 3, 4, 6P
- IEC IP67 Protection



| Housing Style                                | Male Part Number                                   | Features   | Pinout  |                    |
|--|--|--|---|--------------------|
| <p><b>Typical panel cutout is 8.2 mm</b></p> | <b>MFS 3F-*</b>                                    | 3x24 AWG, 105 °C, 125 V, 4 A, mates with 3-pin snap lock or threaded female cordsets, rear mount | <p><b>Male</b></p>  |                    |
|  | <b>MFS 4F-*</b>                                    | 4x24 AWG, 105 °C, 125 V, 4 A, mates with 4-pin snap lock or threaded female cordsets, rear mount | <p><b>Male</b></p>  |                    |
|  | <b>MFS 6F-*</b>                                    | 6x24 AWG, 105 °C, 125 V, 2 A, mates with 6-pin snap lock or threaded female cordsets, rear mount | <p><b>Male</b></p>  |                    |
|  | <p><b>Typical panel cutout is 8.2 x 7.1 mm</b></p> | <b>MFSS 3-*</b>  | 3x24 AWG, 105 °C, 125 V, 4 A, mates with 3-pin snap lock or threaded female cordsets, front mount | <p><b>Male</b></p> |
|  |  | <b>MFSS 4-*</b>  | 4x24 AWG, 105 °C, 125 V, 4 A, mates with 4-pin snap lock or threaded female cordsets, front mount | <p><b>Male</b></p> |
|  |  | <b>MFSS 6-*</b>  | 4x24 AWG, 105 °C, 125 V, 4 A, mates with 4-pin snap lock or threaded female cordsets, front mount | <p><b>Male</b></p> |

We reserve the right to make technical alterations without prior notice.

\* Length in meters. Standard lead length is 0.2 meters. Consult factory for other lengths.  
Standard housing material is nickel plated brass .. "MFS(S).."; "MFS(S)V.." indicates stainless steel.



3, 4 and 6-Pin Receptacles with PCB Pins

- NEMA 1, 3, 4, 6P
- IEC IP67 Protection



We reserve the right to make technical alterations without prior notice.

| Housing Style                | Female Part Number  | Features   | Pinout               |
|------------------------------|---------------------|--|----------------------|
| <p><b>MFKS .. F-PCBF</b></p> | <b>MFKS 3F-PCBF</b> | PCB Pins, 85 °C, 60 V, 4 A, mates with 3-pin threaded male cordsets          | <p><b>Female</b></p> |
|                              | <b>MFKS 4F-PCBF</b> | PCB Pins, 85 °C, 30 V, 4 A, mates with 4-pin threaded male cordsets          | <p><b>Female</b></p> |
|                              | <b>WMFK 3F-PCB</b>  | PCB Pins, 80 °C, 60 VAC/75 VDC, 4 A, mates with 3-pin threaded male cordsets | <p><b>Female</b></p> |
| <p><b>WMFK .. F-PCB</b></p>  | <b>WMFK 4F-PCB</b>  | PCB Pins, 80 °C, 30 VAC/36 VDC, 4 A, mates with 4-pin threaded male cordsets | <p><b>Female</b></p> |
|                              | <b>WMFK 6F-PCB</b>  | PCB Pins, 80 °C, 24 VDC, 1 A, mates with 6-pin threaded male cordsets        | <p><b>Female</b></p> |

Standard housing material is nickel plated brass.

**MFKS 3F-PCBF**

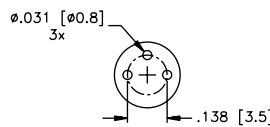

**MFKS 4F-PCBF**

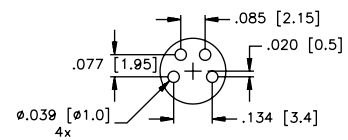

**WMFK 3F-PCB**

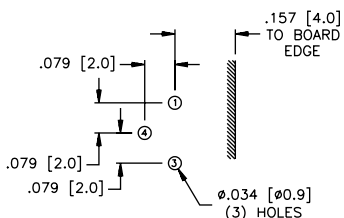

**WMFK 4F-PCB**

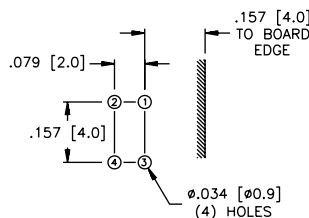

**WMFK 6F-PCB**

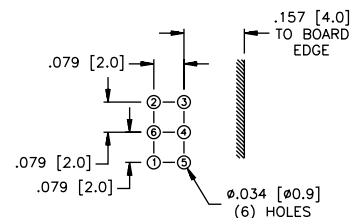

## 3, 4 and 6-Pin Receptacles with PCB Pins

- NEMA 1, 3, 4, 6P
- IEC IP67 Protection



| Housing Style | Male Part Number   | Features  | Pinout          |
|---------------|--------------------|---|-----------------|
|               | <b>WMFS 3-PCB</b>  | PCB Pins, 80 °C, 60 VAC/75 VDC, 4 A, mates with 3-pin snap lock or threaded female cordsets | <b>Male</b><br> |
|               | <b>WMFS 4-PCB</b>  | PCB Pins, 80 °C, 30 VAC/36 VDC, 4 A, mates with 4-pin snap lock or threaded female cordsets | <b>Male</b><br> |
|               | <b>WMFS 6-PCB</b>  | PCB Pins, 80 °C, 24 VDC, 1 A, mates with 6-pin snap lock or threaded female cordsets        | <b>Male</b><br> |
|               | <b>WMFS 3F-PCB</b> | PCB Pins, 80 °C, 75 VDC, 4 A, mates with 3-pin snap lock or threaded female cordsets        | <b>Male</b><br> |
|               | <b>WMFS 4F-PCB</b> | PCB Pins, 80 °C, 36 VDC, 4 A, mates with 4-pin snap lock or threaded female cordsets        | <b>Male</b><br> |
|               | <b>WMFS 6F-PCB</b> | PCB Pins, 80 °C, 24 VDC, 1 A, mates with 6-pin snap lock or threaded female cordsets        | <b>Male</b><br> |

We reserve the right to make technical alterations without prior notice.

Standard housing material is nickel plated brass.

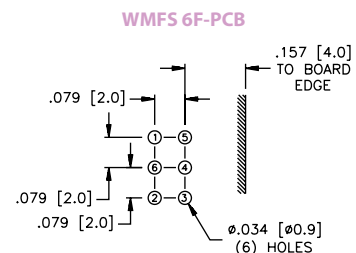
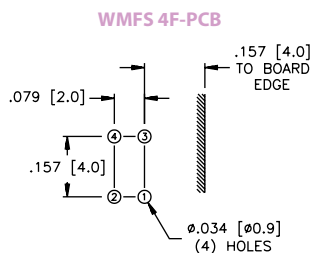
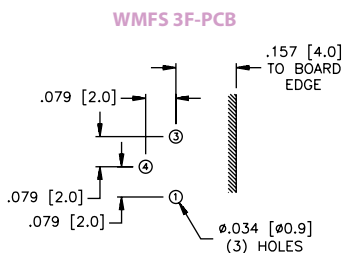
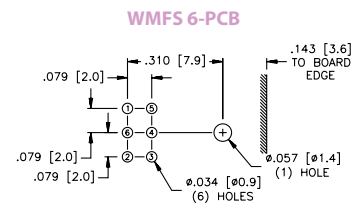
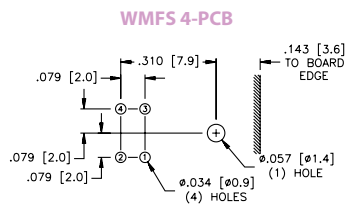
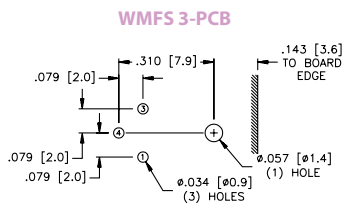

3 and 4-Pin Receptacles with PCB Pins and Mounting Bracket

- IEC IP67 Protection



We reserve the right to make technical alterations without prior notice.

| Housing Style                 | Female Part Number   | Features  | Pinout               |
|-------------------------------|----------------------|---|----------------------|
| <p><b>MFKSH .. F-PCB</b></p>  | <b>MFKSH 3F-PCB</b>  | PCB Pins, 85 °C, 60 V, 4 A, mates with 3-pin threaded male cordsets               | <p><b>Female</b></p> |
| <p><b>MFKSH 4F-PCB</b></p>    | <b>MFKSH 4F-PCB</b>  | PCB Pins, 85 °C, 30 V, 4 A, mates with 4-pin threaded male cordsets               | <p><b>Female</b></p> |
| <p><b>MFKSHL .. F-PCB</b></p> | <b>MFKSHL 3F-PCB</b> | PCB Pins, Long Bracket, 85 °C, 60 V, 4 A, mates with 3-pin threaded male cordsets | <p><b>Female</b></p> |
| <p><b>MFKSHL 4F-PCB</b></p>   | <b>MFKSHL 4F-PCB</b> | PCB Pins, Long Bracket, 85 °C, 30 V, 4 A, mates with 4-pin threaded male cordsets | <p><b>Female</b></p> |
| <p><b>WMFKSH .. F-PCB</b></p> | <b>WMFKSH 3F-PCB</b> | PCB Pins, 85 °C, 60 V, 4 A, mates with 3-pin threaded male cordsets               | <p><b>Female</b></p> |
| <p><b>WMFKSH 4F-PCB</b></p>   | <b>WMFKSH 4F-PCB</b> | PCB Pins, 85 °C, 30 V, 4 A, mates with 4-pin threaded male cordsets               | <p><b>Female</b></p> |

Standard housing material is nickel plated brass.

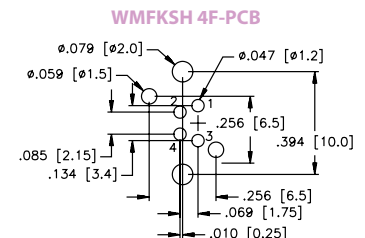
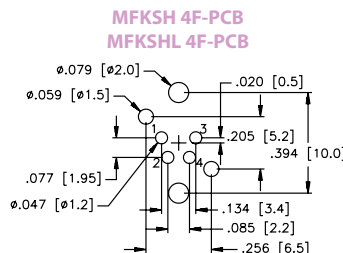
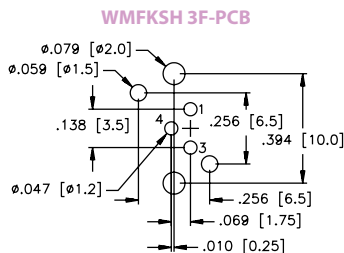
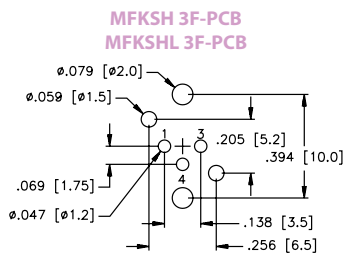

## 3, 4 and 6-Pin Receptacles, Rear Mount with Solder Cups

- NEMA 1, 3, 4, 6P
- IEC IP67 Protection



| Housing Style | Female Part Number | Features   | Pinout               |
|---------------|--------------------|--|----------------------|
|               | <b>MFKS 3F</b>     | Solder Cups, accepts up to 22 AWG conductors, 80 °C, 125 V, 4 A, mates with 3-pin threaded male cordsets | <p><b>Female</b></p> |
|               | <b>MFKS 4F</b>     | Solder Cups, accepts up to 22 AWG conductors, 80 °C, 125 V, 2 A, mates with 4-pin threaded male cordsets | <p><b>Female</b></p> |
|               | <b>MFKS 6F</b>     | Solder Cups, accepts up to 24 AWG conductors, 80 °C, 125 V, 2 A, mates with 6-pin threaded male cordsets | <p><b>Female</b></p> |

Standard housing material is nickel plated brass.

We reserve the right to make technical alterations without prior notice.

3, 4 and 6-Pin Feed-Thru Receptacles

- Female to Male Receptacles
- NEMA 1, 3, 4, 6P
- IEC IP67 Protection



| Housing Style       | Part Number    | Features   | Pinout                                |
|---------------------|----------------|--|---------------------------------------|
| <p>MFSV MFKV ..</p> | MFSV MFKV 3/M8 | 3-conductor, 80 °C, 125 V, 4 A, mates with 3-pin threaded cordsets | <p><b>Female</b>      <b>Male</b></p> |
| <p>MFSV MFKV ..</p> | MFSV MFKV 4/M8 | 4-conductor, 80 °C, 125 V, 2 A, mates with 4-pin threaded cordsets | <p><b>Female</b>      <b>Male</b></p> |
| <p>MFSV MFKV ..</p> | MFSV MFKV 6/M8 | 6-conductor, 80 °C, 125 V, 2 A, mates with 6-pin threaded cordsets | <p><b>Female</b>      <b>Male</b></p> |

Standard housing material is nickel plated brass.

We reserve the right to make technical alterations without prior notice.

Receptacles

• IEC IP67 Protection



| Housing Style              | Female Part Number | Male Part Number | Features  | Pinout                                  |
|----------------------------|--------------------|------------------|---|---|
| <p><b>B 513(4)1-0</b></p>  | <b>B 5131-0</b>    | <b>BS 5131-0</b> | PBT, Black, accepts 3-5 mm cable diameter, solder terminals, accepts up to 24 AWG conductors, 85 °C, 60 VAC/75 VDC, 4 A, mates with 4-pin threaded cordsets and receptacles | <p><b>Female</b></p> <p><b>Male</b></p> |
| <p><b>BS 513(4)1-0</b></p> | <b>B 5141-0</b>    | <b>BS 5141-0</b> | PBT, Black, accepts 3-5 mm cable diameter, solder terminals, accepts up to 24 AWG conductors, 85 °C, 30 VAC/36 VDC, 4 A, mates with 4-pin threaded cordsets and receptacles | <p><b>Female</b></p> <p><b>Male</b></p> |
| <p><b>B 513(4)3-0</b></p>  | <b>B 5133-0</b>    | <b>BS 5133-0</b> | PBT, Black, accepts 3-5 mm cable diameter, screw terminals, accepts up to 22 AWG conductors, 85 °C, 60 VAC/75 VDC, 4 A, mates with 3-pin threaded cordsets and receptacles  | <p><b>Female</b></p> <p><b>Male</b></p> |
| <p><b>BS 513(4)3-0</b></p> | <b>B 5143-0</b>    | <b>BS 5143-0</b> | PBT, Black, accepts 3-5 mm cable diameter, screw terminals, accepts up to 22 AWG conductors, 85 °C, 60 VAC/75 VDC, 4 A, mates with 4-pin threaded cordsets and receptacles  | <p><b>Female</b></p> <p><b>Male</b></p> |

We reserve the right to make technical alterations without prior notice.

3 and 4-Pin Field Wireable Connectors, Standard

- IEC IP67 Protection



| Housing Style              | Female Part Number | Male Part Number | Features  | Pinout                                  |
|----------------------------|--------------------|------------------|---|---|
| <p><b>BS 513(4)2-0</b></p> |                    | <b>BS 5132-0</b> | PBT, Black, accepts 3-5 mm cable diameter, solder terminals, accepts up to 26 AWG conductors, 85 °C, 60 VAC/75 VDC, 4 A, mates with 3-pin female snap-lock cordsets, receptacles and junction boxes and threaded cordsets | <p><b>Male</b></p>                      |
|                            |                    | <b>BS 5142-0</b> | PBT, Black, accepts 3-5 mm cable diameter, solder terminals, accepts up to 26 AWG conductors, 85 °C, 60 VAC/75 VDC, 2 A, mates with 3-pin female snap-lock cordsets, receptacles and junction boxes and threaded cordsets | <p><b>Male</b></p>                      |
| <p><b>B 523(4)1-0</b></p>  | <b>B 5231-0</b>    | <b>BS 5231-0</b> | PBT, Black, Accepts 3-5 mm cable diameter, solder terminals, accepts up to 24 AWG conductors, 85 °C, 60 VAC/75 VDC, 4 A, mates with 3-pin threaded cordsets and receptacles   | <p><b>Female</b></p> <p><b>Male</b></p> |
| <p><b>BS 523(4)1-0</b></p> | <b>B 5241-0</b>    | <b>BS 5241-0</b> | PBT, Black, accepts 3-5 mm cable diameter, solder terminals, accepts up to 24 AWG conductors, 85 °C, 30 VAC/36 VDC, 4 A, mates with 4-pin threaded cordsets and receptacles   | <p><b>Female</b></p> <p><b>Male</b></p> |

We reserve the right to make technical alterations without prior notice.

Field Wireables

## 3 and 4-Pin Field Wireable Connectors, IDC

- Insulation Displacement Technology
- No Conductor Stripping Required
- IEC IP67 Protection



| Housing Style              | Female Part Number |                  | Features  | Pinout                                  |
|----------------------------|--------------------|------------------|---|---|
| <p><b>B 513(4)6-0</b></p>  | <b>B 5136-0</b>    | <b>BS 5136-0</b> | Nickel plated brass, accepts 4-5 mm cable diameter, IDC, accepts 22-26 AWG conductors, 85 °C, 32 V, 4 A, mates with 3-pin threaded cordsets and receptacles | <p><b>Female</b></p> <p><b>Male</b></p> |
| <p><b>BS 513(4)6-0</b></p> | <b>B 5146-0</b>    | <b>BS 5146-0</b> | Nickel plated brass, accepts 4-5 mm cable diameter, IDC, accepts 22-26 AWG conductors, 85 °C, 32 V, 4 A, mates with 4-pin threaded cordsets and receptacles | <p><b>Female</b></p> <p><b>Male</b></p> |

We reserve the right to make technical alterations without prior notice.



## M8 Picofast to M12 Eurofast® Adapters

- Enables Picofast and Eurofast Connectors to be interchanged
- Eurofast Connection has Anti-vibration Coupling Nut
- IEC IP67 Protection



| Housing Style           | Part Number            | Features   | Wiring Diagram |
|-------------------------|------------------------|--|----------------|
| <p><b>FKMR 4 ..</b></p> | <b>FKMR 4-ESM 3S</b>   | TPU body, 60 VAC/75 VDC, 4 A, 80 °C, female Eurofast, male snap-lock Picofast connector, 3-pin |                |
|                         | <b>FKMR 4.4-ESM 4S</b> | TPU body, 30 VAC/36 VDC, 4 A, 80 °C, female Eurofast, male snap-lock Picofast connector, 4-pin |                |
| <p><b>FSMR 4 ..</b></p> | <b>FSMR 4-SKM 3</b>    | TPU body, 60 VAC/75 VDC, 4 A, 80 °C, male Eurofast, female threaded Picofast connector, 3-pin  |                |
|                         | <b>FSMR 4.4-SKM 4</b>  | TPU body, 30 VAC/36 VDC, 4 A, 80 °C, male Eurofast, female threaded Picofast connector, 4-pin  |                |

Add "/S857" to the end of part description to specify addition of mounting hole.

We reserve the right to make technical alterations without prior notice.

Field Wireables

### Pinouts

| 3-Pin Picofast | 4-Pin Picofast | 4-Pin Eurofast | 3-Pin Picofast | 4-Pin Picofast | 4-Pin Eurofast |
|----------------|----------------|----------------|----------------|----------------|----------------|
| Female         |                |                | Male           |                |                |
|                |                |                |                |                |                |

## Connector Inserts

- For use in Sensors and Custom Receptacles
- Clear Body versions for use with Indicator LEDs
- Solder Lug or Printed Circuit Pin mounting options



| Housing Style  | Female Part Number      | Features   | Pinout      |
|--|-------------------------|--|-------------|
| <p><b>ESM ..</b></p> <p>.476 [12.1] .280 [7.1]<br/>                 .228 [5.8] ∅ .272 [6.9]<br/>                 .069 [1.75]</p> | <b>ESM 3S (10/BAG)</b>  | Nylon, black, solder cup, accepts 26 AWG, 60 VAC/75 VDC, 4 A, 80 °C, 3-pin snap lock   | <p>Male</p> |
|  | <b>ESM 4S (10/BAG)</b>  | Nylon, black, solder cup, accepts 28 AWG, 30 VAC/36 VDC, 4 A, 80 °C, 4-pin snap lock   | <p>Male</p> |
|  | <b>ESM 6S (10/BAG)</b>  | Nylon, black, solder cup, accepts 26 AWG, 24 VDC, 1 A, 80 °C, 6-pin snap lock  | <p>Male</p> |
| <p><b>ESHM ..</b></p> <p>.650 [16.5] .551 [14.0] .354 [9.0]<br/>                 ∅.228 [5.8] ∅.274 [6.95]</p>                    | <b>ESHM 3L (10/BAG)</b> | Nickel plated brass and nylon housing, solder cup, accepts 26 AWG, 30 VAC/75 VDC, 4 A, 80 °C, 3-pin snap lock clear body for LED | <p>Male</p> |
|  | <b>ESHM 4L (10/BAG)</b> | Nickel plated brass and nylon housing, solder cup, accepts 26 AWG, 30 VAC/36 VDC, 4 A, 80 °C, 4-pin snap lock clear body for LED | <p>Male</p> |
|  | <b>ESHM 3P (10/BAG)</b> | Nickel plated brass and nylon housing, PCB pin, 60 VAC/75 VDC, 4 A, 80 °C, 3-pin snap lock clear body for LED                    | <p>Male</p> |
|  | <b>ESHM 4P (10/BAG)</b> | Nickel plated brass and nylon housing, PCB pin, 30 VAC/36 VDC, 4 A, 80 °C, 4-pin snap lock clear body for LED                    | <p>Male</p> |

We reserve the right to make technical alterations without prior notice.

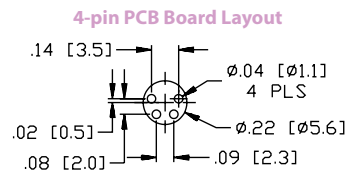
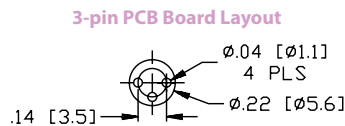
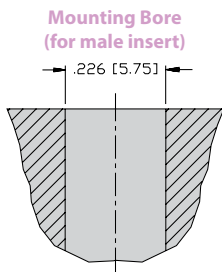

Connector Inserts

- For use in Sensors and Custom Receptacles
- Clear Body versions for use with Indicator LEDs
- Solder Lug or Printed Circuit Pin mounting options



| Housing Style  | Male Part Number        | Features  | Pinout      |
|--|-------------------------|---|-------------|
| <p><b>SESM ..</b></p> <p>Dimensions: <math>\phi .216</math> [5.5], .476 [12.1], .346 [8.8], <math>\phi .335</math> [8.5], <math>\phi .274</math> [6.95] M8x1, .069 [1.75], .228 [5.8]</p> <p><b>ESGM ..</b></p> <p>Dimensions: .650 [16.5], .551 [14.0], .354 [9.0], <math>\phi .228</math> [5.8], <math>\phi .274</math> [6.95]</p> | <b>SESM 3S (10/BAG)</b> | Nickel plated brass and nylon housing, solder cup, accepts 26 AWG, 60 VAC/75 VDC, 4 A, 80 °C, 3-pin snap lock or threaded                                 | <p>Male</p> |
|  | <b>SESM 4S (10/BAG)</b> | Nickel plated brass and nylon housing, solder cup, accepts 28 AWG, 30 VAC/36 VDC, 4 A, 80 °C, 4-pin snap lock or threaded                                 | <p>Male</p> |
|  | <b>ESGM 3L (10/BAG)</b> | Nickel plated brass housing with clear nylon lens, solder cup, accepts 26 AWG, 60 VAC/75 VDC, 4 A, 80 °C, 3-pin snap lock or threaded, clear lens for LED | <p>Male</p> |
|  | <b>ESGM 4L (10/BAG)</b> | Nickel plated brass housing with clear nylon lens, solder cup, accepts 26 AWG, 30 VAC/36 VDC, 4 A, 80 °C, 4-pin snap lock or threaded, clear lens for LED | <p>Male</p> |
|  | <b>ESGM 3P (10/BAG)</b> | Nickel plated brass housing with clear nylon lens, PCB pin, 60 VAC/75 VDC, 4 A, 80 °C, 3-pin snap lock or threaded, clear lens for LED                    | <p>Male</p> |
|  | <b>ESGM 4P (10/BAG)</b> | Nickel plated brass housing with clear nylon lens, PCB pin, 30 VAC/36 VDC, 4 A, 80 °C, 4-pin snap lock or threaded, clear lens for LED                    | <p>Male</p> |

We reserve the right to make technical alterations without prior notice.

Accessories

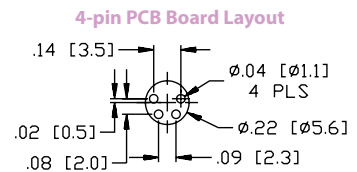
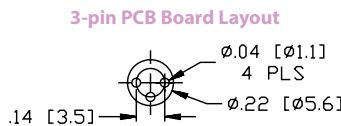
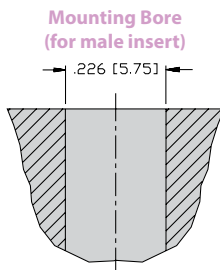

## Connector Inserts

- For use in Sensors and Custom Receptacles
- Clear Body versions for use with Indicator LEDs
- Female Inserts
- Solder Lug or Printed Circuit Pin mounting options

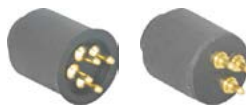

| Housing Style  | Female Part Number      | Features   | Pinout               |
|--|-------------------------|--|----------------------|
| <p><b>MFK ..</b></p> <p>.547 [13.91]<br/>.455 [11.51]<br/>.335 [8.51]<br/>ø.224 [5.71]<br/>ø.327 [8.31]</p> <p><b>MFKB ..</b></p> <p>ø.220 [5.61]<br/>ø.327 [8.31]</p> <p>.378 [9.61]<br/>.071 [1.81]<br/>.547 [13.91]</p> | <b>MFK 3 (10/BAG)</b>   | TPU housing, black, PCB pins, 60 VAC/75 VDC, 4 A, 80 °C, 3-pin snap lock                   | <p><b>Female</b></p> |
|  | <b>MFK 4 (10/BAG)</b>   | TPU housing, black, PCB pins, 30 VAC/36 VDC, 4 A, 80 °C, 4-pin snap lock                   |                      |
|  | <b>MFKB 3 (10/BAG)</b>  | TPU housing, black, PCB pins, 60 VAC/75 VDC, 4 A, 80 °C, 3-pin snap lock                   | <p><b>Female</b></p> |
|  | <b>MFKB 4 (10/BAG)</b>  | TPU housing, black, PCB pins, 30 VAC/36 VDC, 4 A, 80 °C, 4-pin snap lock                   |                      |
|  | <b>MFKB 3L (10/BAG)</b> | TPU housing, black, solder cups, 60 VAC/75 VDC 4 A, 80 °C, 3-pin snap lock, accepts 24 AWG |                      |
|  | <b>MFKB 4L (10/BAG)</b> | TPU housing, black, solder cups, 30 VAC/36 VDC 4 A, 80 °C, 4-pin snap lock, accepts 24 AWG |                      |

We reserve the right to make technical alterations without prior notice.

3-pin PCB Board Layout

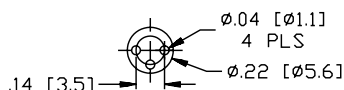

4-pin PCB Board Layout

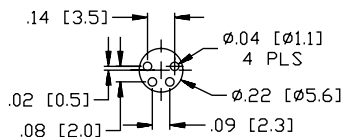

Closure Caps

- For use with Cordsets, Receptacles and Junction Boxes



We reserve the right to make technical alterations without prior notice.

| Housing Style | Part Number            | Features   |
|---------------|------------------------|--|
|               | <b>PSGK-MC (8/BAG)</b> | Nylon, Mates to female snap lock cordsets, receptacles and junction boxes              |
|               | <b>PSGM-CC (8/BAG)</b> | Nylon, Mates to female threaded cordsets, receptacles and junction boxes               |
|               | <b>PSG-CC</b>          | Nickel plated brass, Mates to female threaded cordsets, receptacles and junction boxes |
|               | <b>PSG-MC</b>          | Nickel plated brass, Mates to female threaded cordsets, receptacles and junction boxes |
|               | <b>PKG-CC</b>          | Nickel plated brass, Mates to male threaded cordsets, receptacles and junction boxes   |
|               | <b>PKG-MC</b>          | Nickel plated brass, Mates to male threaded cordsets, receptacles and junction boxes   |

Accessories

**M8 Picofast "Snap Lock" Connector Instructions**

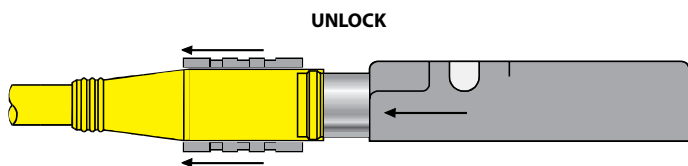

With Turck's patented Locking Sleeve pulled back, any Picofast sensor slides on without any difficulty.

After sensor is connected, push Locking Sleeve forward to create a watertight connection. It's a snap!

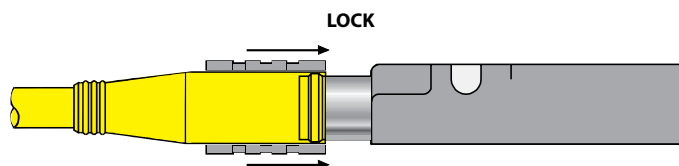

**Installation Instructions**

**To Attach:**

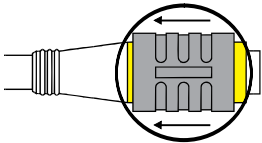
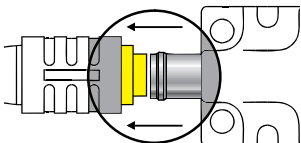
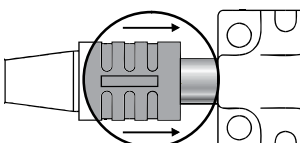
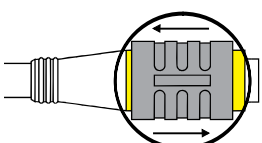
1. Be sure black locking sleeve is pulled back. 
2. Line up pins and push connector onto plug. You will feel a "snap." Do not twist. 
3. Push locking sleeve forward on connector until it is flush with the front of the connector. 
4. If sleeve is difficult to slide on a new connector, "exercise" it a few times. Do not use tools. 

**To Detach:**

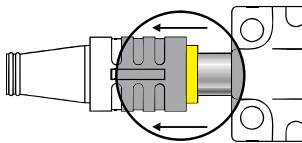
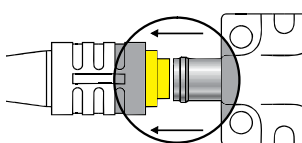
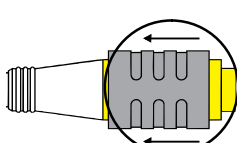
1. Do not twist. 
2. Pull locking sleeve back to "unlocked" position. 
3. Pull connector straight off. 
4. Leave locking sleeve in unlocked position. 







|                         |            |
|-------------------------|------------|
| <b>Part Number Keys</b> | <b>D2</b>  |
| <b>Cordsets</b>         | <b>D7</b>  |
| <b>Receptacles</b>      | <b>D45</b> |
| <b>Field Wireables</b>  | <b>D83</b> |
| <b>Adapters</b>         | <b>D91</b> |
| <b>Inserts</b>          | <b>D94</b> |
| <b>Closure Caps</b>     | <b>D95</b> |

## Features

- 4-12 pins utilizing 2-12 wires
- Nickel-brass, stainless steel and nylon materials
- Fully shielded options
- Multiple connector mold bodies
- Quick-connect selection
- LED options
- Multiple receptacle mounting thread options
- Receptacles with leads, solder cups or PCB pins



## Cordset Part Number key

Part Number Keys are to assist in IDENTIFICATION ONLY. Consult factory for catalog items not identified.

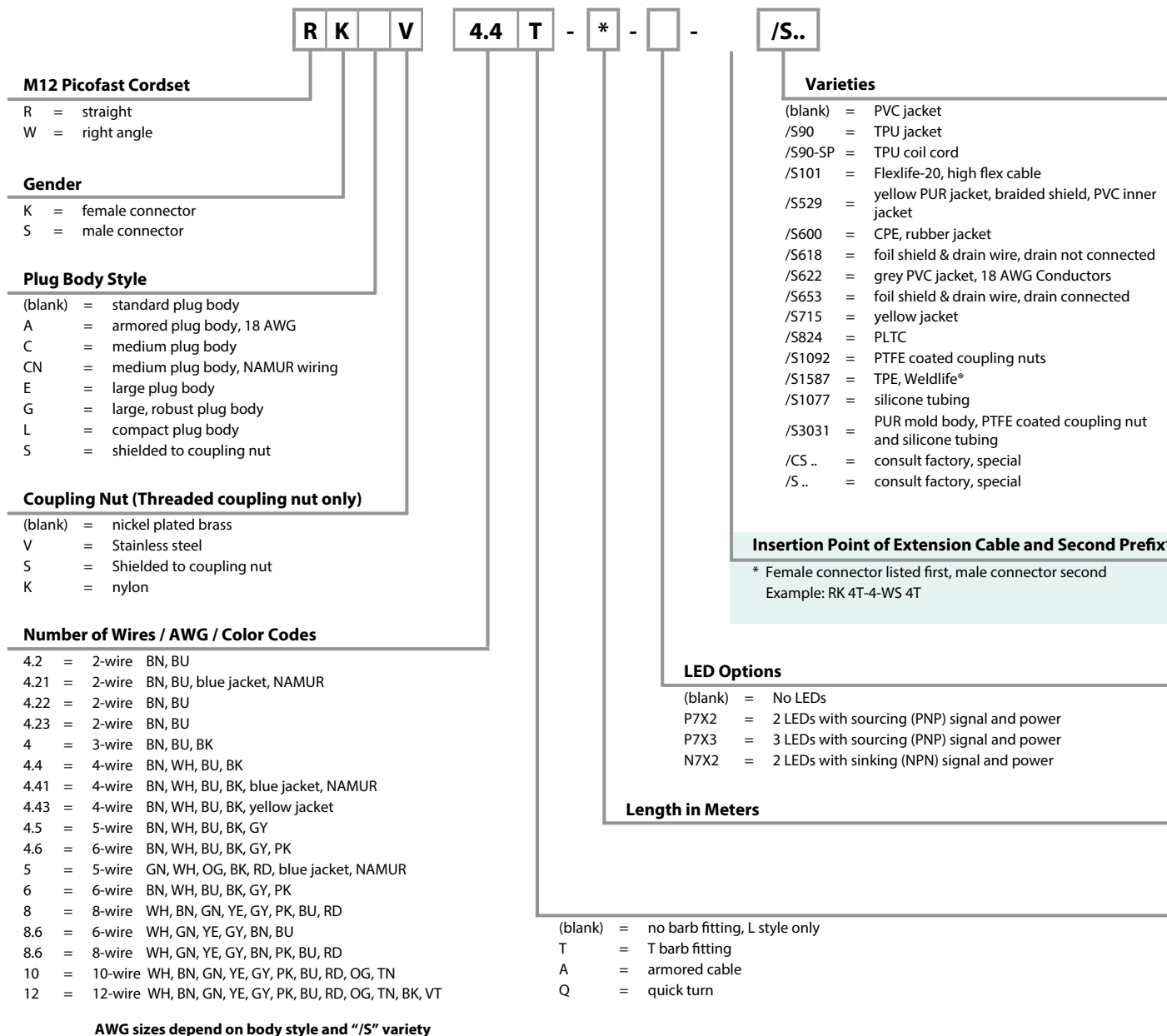

## Cordset Part Number key

### Extension Examples:

Hybrid connector extensions also available. Consult factory.

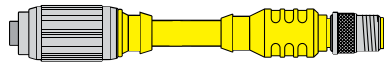

R K G 4.4 T - 2 - R S E 4.4 T /S600



R K 4.4 T - 2 - R S 4.4 T

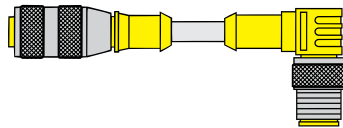

R K 4.4 T - 2 - W S 4.4 T

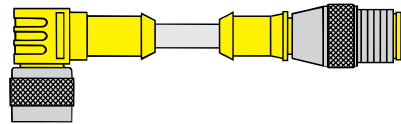

W K 4.4 T - 2 - R S 4.4 T

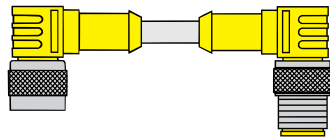

W K 4.4 T - 2 - W S 4.4 T

## Reverse Key (B-Code) Cordset Part Number Key

Part Number Keys are to assist in IDENTIFICATION ONLY. Consult factory for catalog items not identified.

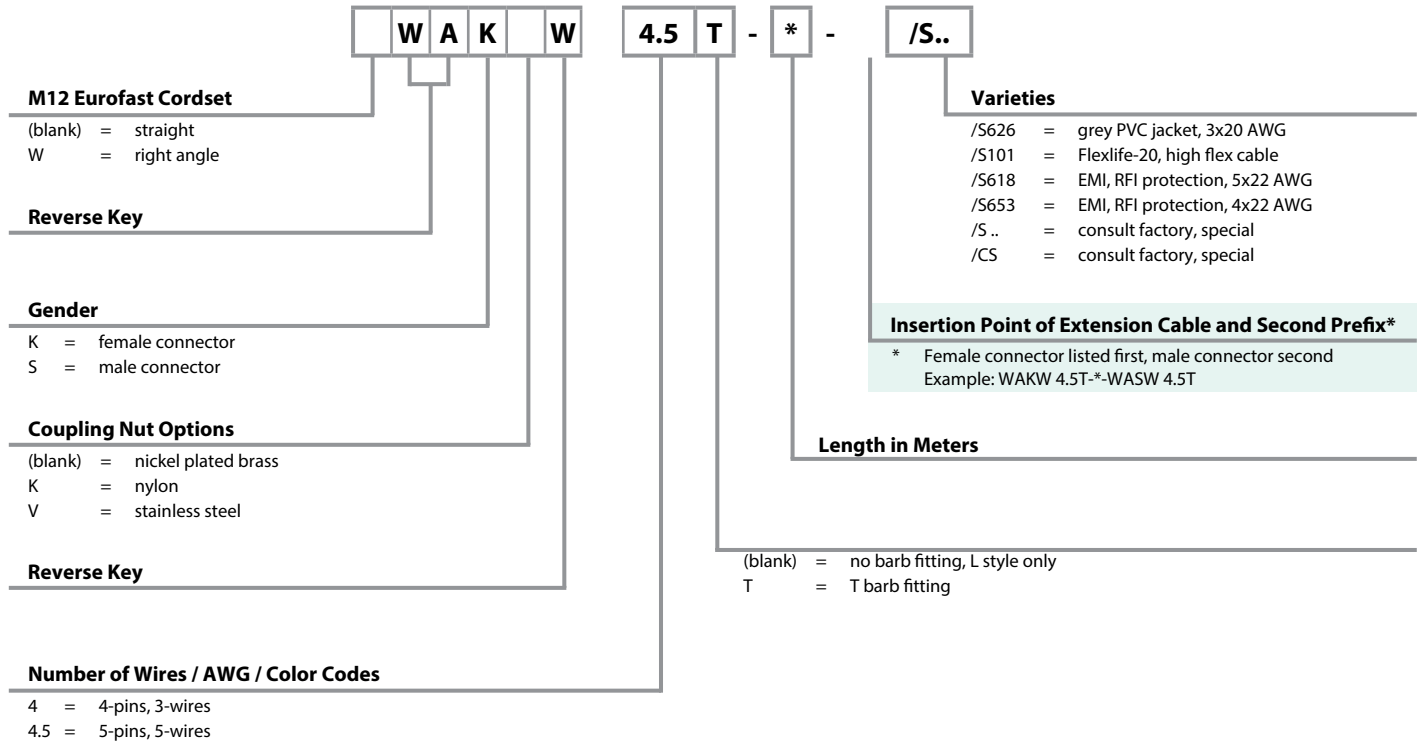

AWG sizes depend on body styles and "/S" variety

## Receptacle Part Number Key

Part Number Keys are to assist in IDENTIFICATION ONLY. Consult factory for catalog items not identified.

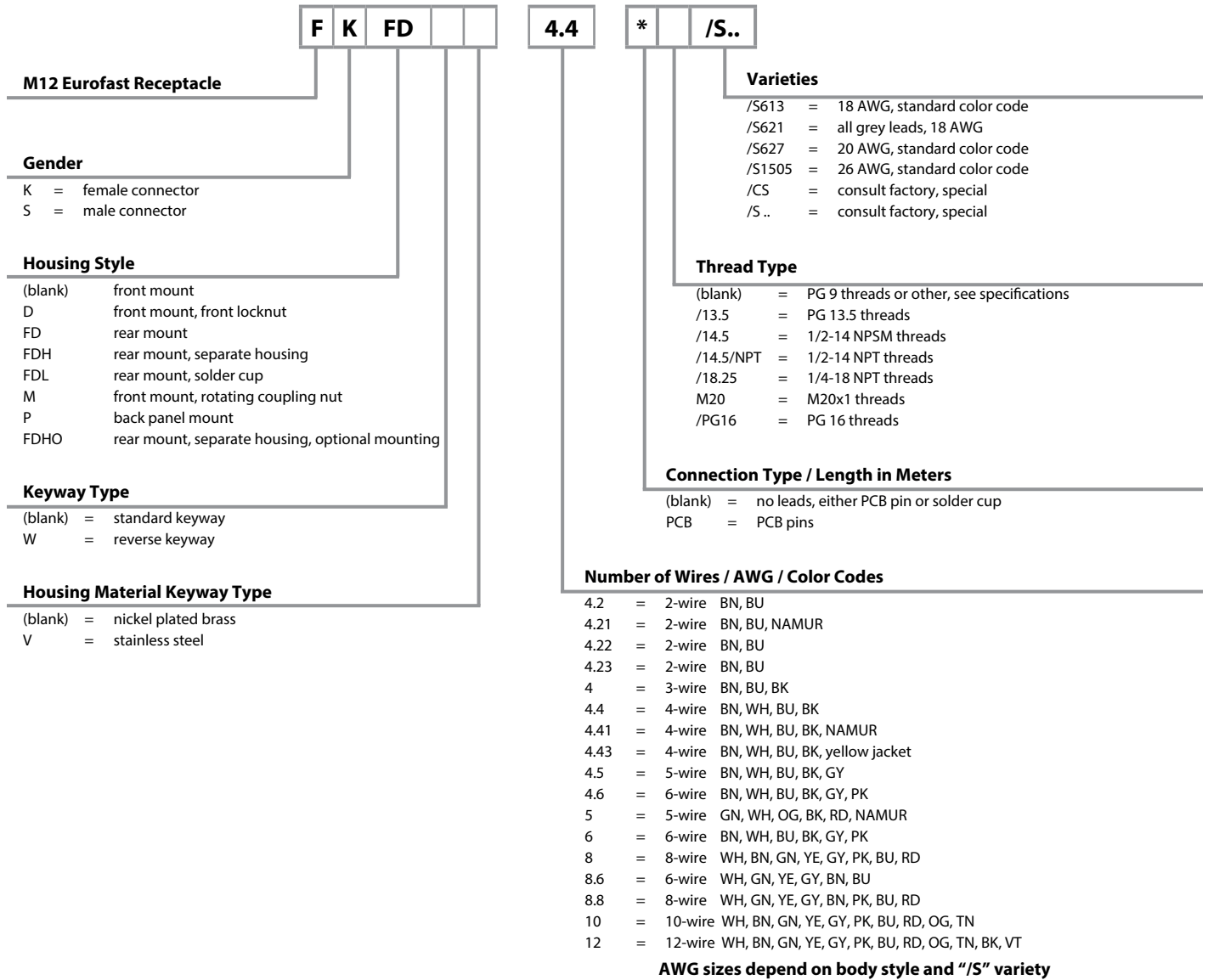

eurofast®

## Field Wireable Part Number Key

Part Number Keys are to assist in IDENTIFICATION ONLY. Consult factory for catalog items not identified.

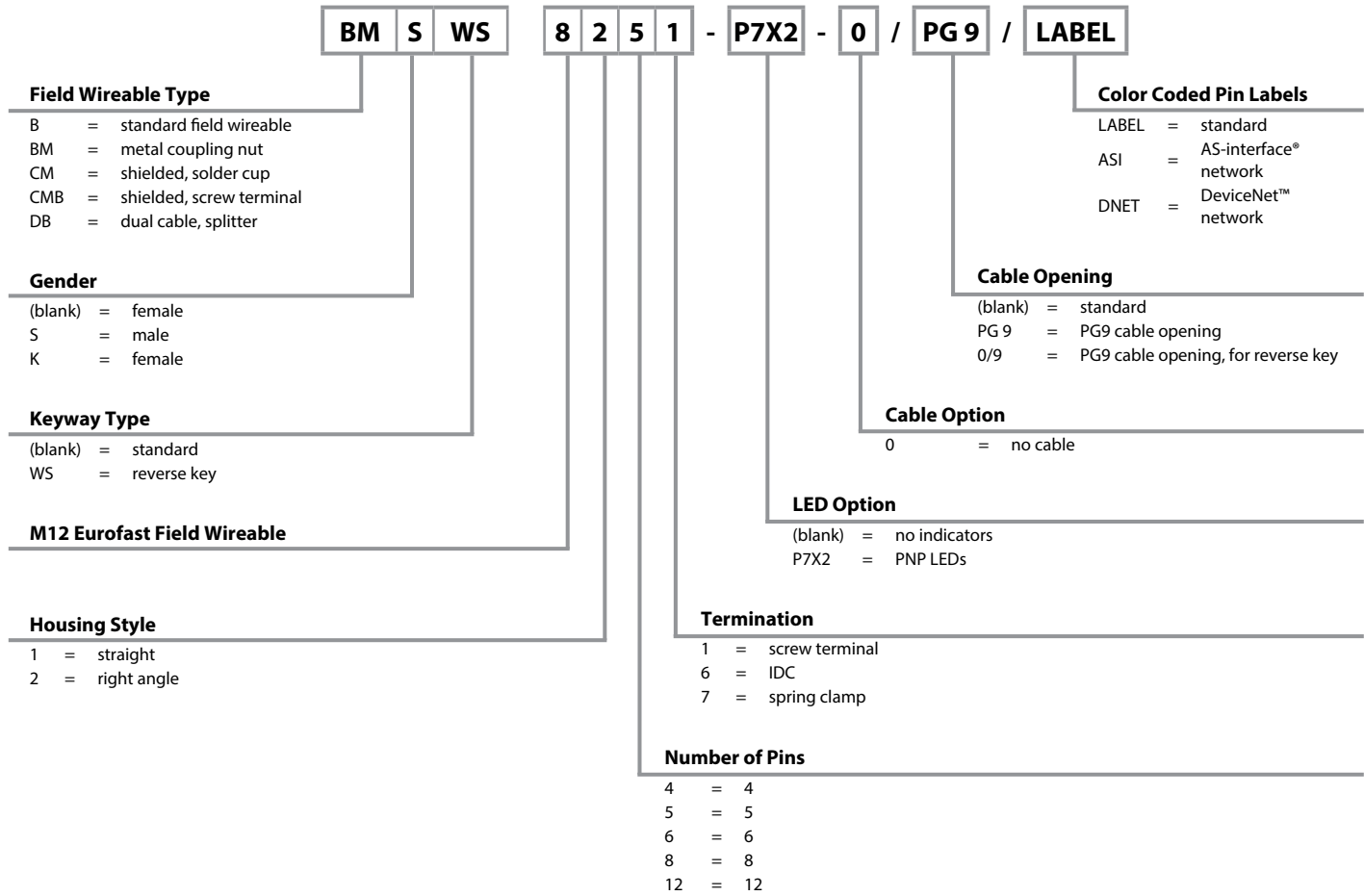

## 2-Wire Cordsets, Standard Plug Body

- NEMA 1, 3, 4, 6P
- IEC IP68 Protection
- 250 V, 4 A



| Connector Style       | Female Part Number                                 | Male Part Number                                   | Features   | Pinout               |
|-----------------------|--|--|--|----------------------|
| <p><b>RK ..**</b></p> | <b>RK 4.2T-*</b><br><b>WK 4.2T-*</b>               | <b>RS 4.2T-*</b><br><b>WS 4.2T-*</b>               | ITC/PLTC PVC Grey, 2x20 AWG, 105 °C, 5.1 mm OD, Cable #RF50529-*M, Flexlife®           | <p><b>Female</b></p> |
|                       | <b>RK 4.2T-*/S90</b><br><b>WK 4.2T-*/S90</b>       | <b>RS 4.2T-*/S90</b><br><b>WS 4.2T-*/S90</b>       | AWM TPU Grey, 2x20 AWG, 90 °C, 4.8 mm OD, Cable #RF50772-*M, Cut/Abrasion Immune       |                      |
| <p><b>WK ..**</b></p> | <b>RK 4.2T-*/S748</b><br><b>WK 4.2T-*/S748</b>     | <b>RS 4.2T-*/S748</b><br><b>WS 4.2T-*/S748</b>     | ITC/PLTC PVC Yellow, 2x22 AWG, 105 °C, 5.1 mm OD, Cable #RF50650-*M, Flexlife          | <p><b>Male</b></p>   |
|                       | <b>RK 4.21T-*/S1511</b><br><b>WK 4.21T-*/S1511</b> | <b>RS 4.21T-*/S1511</b><br><b>WS 4.21T-*/S1511</b> | ITC/PLTC PVC Grey, 2x20 AWM PVC, 105 °C, 5.1 mm OD, Cable #RF50529-*M, Flexlife        |                      |
| <p><b>RS ..**</b></p> | <b>RK 4.21T-*</b><br><b>WK 4.21T-*</b>             | <b>RS 4.21T-*</b><br><b>WS 4.21T-*</b>             | ITC/PLTC PVC NAMUR Blue, 2x20 AWG, 105 °C, 5.1 mm OD, Cable #RF51923-*M                |                      |
|                       | <b>RK 4.21T-*/S90</b><br><b>WK 4.21T-*/S90</b>     | <b>RS 4.21T-*/S90</b><br><b>WS 4.21T-*/S90</b>     | AWM TPU NAMUR Blue, 2x20 AWG, 90 °C, 5.1 mm OD, Cable #RF50657-*M, Cut/Abrasion Immune |                      |
| <p><b>WS ..**</b></p> | <b>RK 4.22T-*</b><br><b>WK 4.22T-*</b>             | <b>RS 4.22T-*</b><br><b>WS 4.22T-*</b>             | ITC/PLTC PVC Grey, 2x20 AWG, 105 °C, 5.1 mm OD, Cable #RF50529-*M, Flexlife            |                      |
|                       | <b>RK 4.23T-*</b><br><b>WK 4.23T-*</b>             | <b>RS 4.23T-*</b><br><b>WS 4.23T-*</b>             |  |                      |

We reserve the right to make technical alterations without prior notice.

\* Length in meters. Standard cable lengths are 2, 4, 5, 6, 8 and 10 meters. Consult factory for other lengths.

\*\* Standard coupling nut material is nickel plated brass "RK .."; "RKK .." indicates nylon and "RKV .." indicates stainless steel.

- NEMA 1, 3, 4, 6P
- IEC IP68 Protection
- 250 V, 4 A



| Connector Style | Female Part Number                         | Male Part Number                           | Features   | Pinout                                  |
|-----------------|--|--|--|---|
|                 | <b>RK 4T-*</b><br><b>WK 4T-*</b>           | <b>RS 4T-*</b><br><b>WS 4T-*</b>           | ITC/PLTC PVC Grey, 3x20 AWG, 105 °C, 5.1 mm OD, Cable #RF52081-*M, Flexlife®   | <p><b>Female</b></p> <p><b>Male</b></p> |
|                 | <b>RK 4T-*/S90</b><br><b>WK 4T-*/S90</b>   | <b>RS 4T-*/S90</b><br><b>WS 4T-*/S90</b>   | AWM TPU Grey, 3x22 AWG, 90 °C, 4.8 mm OD, Cable #RF52080-*M, Cut/Abrasion Immune   |   |
|                 | <b>RK 4T-*/S101</b><br><b>WK 4T-*/S101</b> | <b>RS 4T-*/S101</b><br><b>WS 4T-*/S101</b> | AWM TPE Grey, 3x22 AWG, 105 °C, 4.8 mm OD, Cable #RF52085-*M, Flexlife-20, High Flex Over 20 Million Cycles                        |   |
|                 | <b>RK 4T-*/S529</b><br><b>WK 4T-*/S529</b> | <b>RS 4T-*/S529</b><br><b>WS 4T-*/S529</b> | TPU/Heavy Braid Double Jacket Yellow, 3x22 AWG, 90 °C, 4.8 mm OD, Cable #RF52084-*M, Cut/Abrasion Immune Braided Mechanical Shield |   |
|                 | <b>RK 4T-*/S824</b><br><b>WK 4T-*/S824</b> | <b>RS 4T-*/S824</b><br><b>WS 4T-*/S824</b> | ITC/PLTC AWM PVC Grey, 3x22 AWG, 105 °C, 5.1 mm OD, Cable #RF52081-*M, Tray Rated, Flexlife  |   |
|                 | <b>RK 4T-*/S715</b><br><b>WK 4T-*/S715</b> | <b>RS 4T-*/S715</b><br><b>WS 4T-*/S715</b> | ITC/PLTC PVC Yellow, 3x22 AWG, 105 °C, 5.1 mm OD, Cable #RF52087-*M, Flexlife  |   |
|                 | <b>RK 4T-*/S760</b><br><b>WK 4T-*/S760</b> | <b>RS 4T-*/S760</b><br><b>WS 4T-*/S760</b> | ITC/PLTC PVC Black, 3x22 AWG, 105 °C, 5.1 mm OD, Cable #RF52083-*M, Flexlife   |   |
|                 | <b>RK 4T-*/S618</b><br><b>WK 4T-*/S618</b> | <b>RS 4T-*/S618</b><br><b>WS 4T-*/S618</b> | ITC/PLTC PVC Grey, 3x22 AWG, Foil/Drain, 105 °C, 5.1 mm OD, Cable #RF52082-*M, RFI/EMI Shielding, tray rated                       |   |

\* Length in meters. Standard cable lengths are 2, 4, 5, 6, 8 and 10 meters. Consult factory for other lengths.

\*\* Standard coupling nut material is nickel plated brass "RK.."; "RKK.." indicates nylon and "RKV.." indicates stainless steel.

We reserve the right to make technical alterations without prior notice.



## 4-Wire Cordsets, Standard Plug Body

- NEMA 1, 3, 4, 6P
- IEC IP68 Protection
- 250 V, 4 A



We reserve the right to make technical alterations without prior notice.

| Connector Style   | Female Part Number                                       | Male Part Number  | Features   | Pinout  |
|---|--|---|--|---|
| <p><b>RK ..**</b></p> <p><b>WK ..**</b></p> <p><b>RS ..**</b></p> <p><b>WS ..**</b></p> | <b>RK 4.41T-*</b><br><b>WK 4.41T-*</b>                   | <b>RS 4.41T-*</b><br><b>WS 4.41T-*</b>  | ITC/PLTC PVC NAMUR Blue, 4x22 AWG, 105 °C, 5.3 mm OD, Cable #RF50598-*M, Flexlife®   | <p><b>Female</b></p> <p>1. BN<br/>2. WH<br/>3. BU<br/>4. BK</p><br><p><b>Male</b></p> |
|   | <b>RK 4.41T-*/S529</b><br><b>WK 4.41T-*/S529</b>         | <b>RS 4.41T-*/S529</b><br><b>WS 4.41T-*/S529</b>  | TPU/Heavy Braid Double Jacket Yellow, 4x20 AWG, 90 °C, 5.7 mm OD, Cable #RF50526-*M, Cut/Abrasion Immune Braided Mechanical Shield |   |
|   | <b>RK 4.43T-*</b><br><b>WK 4.43T-*</b>                   | <b>RS 4.43T-*</b><br><b>WS 4.43T-*</b>  | ITC/PLTC PVC Yellow, 4x22 AWG, 105 °C, 5.3 mm OD, Cable #RF50530-*M, Flexlife  |   |
|   | <b>RK 4.43T-*/S90</b><br><b>WK 4.43T-*/S90</b>           | <b>RS 4.43T-*/S90</b><br><b>WS 4.43T-*/S90</b>  | AWM TPU Yellow, 4x22 AWG, 90 °C, 5.1 mm OD, Cable #RF50613-*M, Cut/Abrasion Immune   |   |
|   | <b>RK 4.4T-*</b><br><b>WK 4.4T-*</b>                     | <b>RS 4.4T-*</b><br><b>WS 4.4T-*</b>  | ITC/PLTC PVC Grey, 4x22 AWG, 105 °C, 5.3 mm OD, Cable #RF50516-*M, Flexlife  |   |
|   | <b>RK 4.4T-*/S90</b><br><b>WK 4.4T-*/S90</b>             | <b>RS 4.4T-*/S90</b><br><b>WS 4.4T-*/S90</b>  | AWM TPU Grey, 4x22 AWG, 90 °C, 5.1 mm OD, Cable #RF50532-*M, Cut/Abrasion Immune   |   |
|   | <b>RK 4.4T-*/S101</b><br><b>WK 4.4T-*/S101</b>           | <b>RS 4.4T-*/S101</b><br><b>WS 4.4T-*/S101</b>  | AWM TPE Grey, 4x22 AWG, 105 °C, 5.1 mm OD, Cable #RF50941-*M, Flexlife-20, High Flex Over 20 Million Cycles                        |   |
|   | <b>RK 4.4T-*/S824</b><br><b>WK 4.4T-*/S824</b>           | <b>RS 4.4T-*/S824</b><br><b>WS 4.4T-*/S824</b>  | ITC/PLTC PVC Grey, 4x22 AWG, 105 °C, 5.3 mm OD, Cable #RF50698-*M, Tray Rated  |   |
|   | <b>RK 4.4T-*/S618</b><br><b>WK 4.4T-*/S618</b>           | <b>RS 4.4T-*/S618</b><br><b>WS 4.4T-*/S618</b>  | ITC/PLTC PVC Grey, 4x22 AWG Foil/Drain, 105 °C, 5.3 mm OD, Cable #RF50577-*M, RFI/EMI Shielding                                    |   |
| <b>RK 4.4T-*/S618/S824</b><br><b>WK 4.4T-*/S618/S824</b>                                | <b>RS 4.4T-*/S618/S824</b><br><b>WS 4.4T-*/S618/S824</b> | ITC/PLTC PVC Grey, 4x22 AWG Foil/Drain, 105 °C, 5.3 mm OD, Cable #RF50777-*M, RFI/EMI Shielding, Tray Rated |  |   |

\* Length in meters. Standard cable lengths are 2, 4, 5, 6, 8 and 10 meters. Consult factory for other lengths.

\*\* Standard coupling nut material is nickel plated brass "RK .."; "RKK .." indicates nylon and "RKV .." indicates stainless steel.

## 4-Wire Cordsets, Standard Plug Body

- NEMA 1, 3, 4, 6P
- IEC IP68 Protection
- 250 V, 4 A



| Connector Style       | Female Part Number   | Male Part Number   | Features  | Pinout  |
|-----------------------|--|--|---|---|
| <p><b>RK ..**</b></p> | <p><b>RK 4.4T-*/S653</b><br/><b>WK 4.4T-*/S653</b></p>         | <p><b>RS 4.4T-*/S653</b><br/><b>WS 4.4T-*/S653</b></p>         | <p>ITC/PLTC PVC Grey, 3x22 AWG Foil/Drain, 105 °C, 5.1 mm OD, Cable #RF52082-*M, RFI/EMI Shielding, Tray Rated</p>                                  | <p>1. BN<br/>2. Drain<br/>3. BU<br/>4. BK</p> |
| <p><b>WK ..**</b></p> | <p><b>RK 4.4T-*/S760</b><br/><b>WK 4.4T-*/S760</b></p>         | <p><b>RS 4.4T-*/S760</b><br/><b>WS 4.4T-*/S760</b></p>         | <p>ITC/PLTC PVC Black, 4x22 AWG, 105 °C, 5.3 mm OD, Cable #RF50983-*M, Flexlife®</p>  | <p><b>Female</b></p>                          |
| <p><b>RS ..**</b></p> | <p><b>RK 4.4T-*/S90/S670</b><br/><b>WK 4.4T-*/S90/S670</b></p> | <p><b>RS 4.4T-*/S90/S670</b><br/><b>WS 4.4T-*/S90/S670</b></p> | <p>AWM TPU Black, 4x26 AWG, 90 °C, 4.2 mm OD, Cable #RF50586-*M, Cut/Abrasion Immune</p>  |   |
| <p><b>RS ..**</b></p> | <p><b>RK 4.4T-*/S1587</b><br/><b>WK 4.4T-*/S1587</b></p>       | <p><b>RS 4.4T-*/S1587</b><br/><b>WS 4.4T-*/S1587</b></p>       | <p>ITC/PLTC TPE Yellow, 4x22 AWG, 105 °C, 5.3 mm OD, Cable #RF51132-*M, Weldlife, Weld Flash Immune</p>   | <p>1. BN<br/>2. WH<br/>3. BU<br/>4. BK</p>    |
| <p><b>WS ..**</b></p> | <p><b>RK 4.4T-*/S1666</b><br/><b>WK 4.4T-*/S1666</b></p>       | <p><b>RS 4.4T-*/S1666</b><br/><b>WS 4.4T-*/S1666</b></p>       | <p>AWM TPU Grey, 2: 2x22 AWG, STP Foil/Drain, 90 °C, 6.2 mm OD, Cable #RF51069-*M, Cut/Abrasion Immune, Shielded Twisted Pair for Communication</p> | <p><b>Male</b></p>                            |

We reserve the right to make technical alterations without prior notice.

\* Length in meters. Standard cable lengths are 2, 4, 5, 6, 8 and 10 meters. Consult factory for other lengths.  
 \*\* Standard coupling nut material is nickel plated brass "RK .."; "RKK .." indicates nylon and "RKV .." indicates stainless steel.

## 5-Wire Cordsets, Standard Plug Body

- NEMA 1, 3, 4, 6P
- IEC IP68 Protection
- 250 V, 4 A



We reserve the right to make technical alterations without prior notice.

| Connector Style       | Female Part Number                               | Male Part Number                                 | Features  | Pinout  |
|-----------------------|--|--|---|---|
| <p><b>RK ..**</b></p> | <b>RK 4.5T-*</b><br><b>WK 4.5T-*</b>             | <b>RS 4.5T-*</b><br><b>WS 4.5T-*</b>             | ITC/PLTC PVC Grey, 5x22 AWG, 105 °C, 5.7 mm OD, Cable #RF50543-*M, Flexlife®                                | <p><b>Female</b></p> <p>1. BN<br/>2. WH<br/>3. BU<br/>4. BK<br/>5. GY</p><br><p><b>Male</b></p> <p>1. BN<br/>2. WH<br/>3. BU<br/>4. BK<br/>5. Drain</p> |
|                       | <b>RK 4.5T-*/S90</b><br><b>WK 4.5T-*/S90</b>     | <b>RS 4.5T-*/S90</b><br><b>WS 4.5T-*/S90</b>     | AWM TPU Grey, 5x22 AWG, 90 °C, 5.3 mm OD, Cable #RF50649-*M, Cut/Abrasion Immune                            |   |
| <p><b>WK ..**</b></p> | <b>RK 4.5T-*/S101</b><br><b>WK 4.5T-*/S101</b>   | <b>RS 4.5T-*/S101</b><br><b>WS 4.5T-*/S101</b>   | AWM TPE Grey, 5x22 AWG, 105 °C, 5.1 mm OD, Cable #RF50909-*M, Flexlife-20, High Flex Over 20 Million Cycles |   |
|                       | <b>RK 4.5T-*/S618</b><br><b>WK 4.5T-*/S618</b>   | <b>RS 4.5T-*/S618</b><br><b>WS 4.5T-*/S618</b>   | ITC/PLTC PVC Grey, 5x22 AWG Foil/Drain, 105 °C, 5.7 mm OD, Cable #RF50609-*M, RFI/EMI Protection            |   |
| <p><b>RS ..**</b></p> | <b>RS 4.5T-*/S715</b><br><b>WS 4.5T-*/S715</b>   | <b>RS 4.5T-*/S715</b><br><b>WS 4.5T-*/S715</b>   | ITC/PLTC PVC Yellow, 5x22 AWG, 105 °C, 5.7 mm OD, Cable #RF50684-*M, Flexlife                               |   |
|                       | <b>RK 4.5T-*/S653</b><br><b>WK 4.5T-*/S653</b>   | <b>RS 4.5T-*/S653</b><br><b>WS 4.5T-*/S653</b>   | ITC/PLTC PVC Grey, 4x22 AWG Foil/Drain, 105 °C, 5.3 mm OD, Cable #RF50577-*M, RFI/EMI Shielding             |   |
| <p><b>WS ..**</b></p> | <b>RK 4.5T-*/S1554</b><br><b>WK 4.5T-*/S1554</b> | <b>RS 4.5T-*/S1554</b><br><b>WS 4.5T-*/S1554</b> | ITC/PLTC PVC Black, 5x22 AWG Foil/Drain, 105 °C, 5.7 mm OD, Cable #RF50794-*M, RFI/EMI Shielding            |   |

\* Length in meters. Standard cable lengths are 2, 4, 5, 6, 8 and 10 meters. Consult factory for other lengths.

\*\* Standard coupling nut material is nickel plated brass "RK .."; "RKK .." indicates nylon and "RKV .." indicates stainless steel.

Cordsets

## 6-Wire Cordsets, Standard Plug Body

- NEMA 1, 3, 4, 6P
- IEC IP68 Protection
- 250 V, 4 A



| Connector Style      | Female Part Number   | Male Part Number   | Features   | Pinout   |
|----------------------|--|--|--|--|
| <p><b>RK..**</b></p> | <p><b>RK 4.6T-*</b><br/><b>WK 4.6T-*</b></p>                   | <p><b>RS 4.6T-*</b><br/><b>WS 4.6T-*</b></p>                   | <p>AWM PVC Grey, 6x24 AWG,<br/>105 °C, 5.1 mm OD, Cable<br/>#RF50608-*M, Flexlife®</p>                                 | <p><b>Female</b></p> <p>1. BN<br/>2. WH<br/>3. BU<br/>4. BK<br/>5. GY<br/>6. PK</p> <p><b>Male</b></p> <p>1. BN<br/>2. WH<br/>3. BU<br/>4. BK<br/>5. GY<br/>6. Drain</p> |
| <p><b>WK..**</b></p> | <p><b>RK 4.6T-*/S90</b><br/><b>WK 4.6T-*/S90</b></p>           | <p><b>RS 4.6T-*/S90</b><br/><b>WS 4.6T-*/S90</b></p>           | <p>AWM TPU Grey, 6x24<br/>AWG, 90 °C, 5.1 mm OD,<br/>Cable #RF50646-*M, Cut/<br/>Abrasion Immune</p>                   |  |
| <p><b>RS..**</b></p> | <p><b>RK 4.6T-*/S90/S760</b><br/><b>WK 4.6T-*/S90/S760</b></p> | <p><b>RS 4.6T-*/S90/S760</b><br/><b>WS 4.6T-*/S90/S760</b></p> | <p>AWM TPU Black, 6x24<br/>AWG, 90 °C, 5.1 mm OD,<br/>Cable #RF50728-*M, Cut/<br/>Abrasion Immune</p>                  |  |
| <p><b>WS..**</b></p> | <p><b>RK 4.6T-*/S618</b><br/><b>WK 4.6T-*/S618</b></p>         | <p><b>RS 4.6T-*/S618</b><br/><b>WS 4.6T-*/S618</b></p>         | <p>AWM PVC Grey, 6x24 AWG<br/>Foil/Drain, 105 °C, 5.1 mm<br/>OD, Cable #RF50610-*M,<br/>RFI/EMI Shielding</p>          |  |
|                      | <p><b>RK 4.6T-*/S653</b><br/><b>WK 4.6T-*/S653</b></p>         | <p><b>RS 4.6T-*/S653</b><br/><b>WS 4.6T-*/S653</b></p>         | <p>ITC/PLTC PVC Grey, 5x22<br/>AWG Foil/Drain, 105 °C,<br/>5.7 mm OD, Cable<br/>#RF50609-*M, RFI/EMI<br/>Shielding</p> |  |

We reserve the right to make technical alterations without prior notice.

\* Length in meters. Standard cable lengths are 2, 4, 6, 8 and 10 meters. Consult factory for other lengths.

\*\* Standard coupling nut material is nickel plated brass "RK.."; "RKK.." indicates nylon and "RKV.." indicates stainless steel.

## 10 and 12-Wire Cordsets, Standard Plug Body

- NEMA 1, 3, 4, 6P
- IEC IP68 Protection
- 60 VAC/75 VDC, 2 A



| Connector Style | Female Part Number  | Male Part Number    | Features  | Pinout   |
|-----------------|---------------------|---------------------|---|--|
| <p>RK..**</p>   | <b>RK 10T-*</b>     | <b>RS 10T-*</b>     | AWM PVC Grey, 10x24 AWG, 105 °C, 6.2 mm OD, Cable #RF51004-*M, Flexlife®          | <ol style="list-style-type: none"> <li>1. WH</li> <li>2. BN</li> <li>3. GN</li> <li>4. YE</li> <li>5. GY</li> </ol>                                  |
|                 | <b>RK 10T-*/S90</b> | <b>RS 10T-*/S90</b> | AWM TPU Grey, 10x24 AWG, 90 °C, 6.2 mm OD, Cable #RF51005-*M, Cut/Abrasion Immune | <ol style="list-style-type: none"> <li>6. PK</li> <li>7. BU</li> <li>8. RD</li> <li>9. OG</li> <li>10. TN</li> </ol>                                 |
| <p>RS..**</p>   | <b>RK 12T-*</b>     | <b>RS 12T-*</b>     | AWM PVC Grey, 12x24 AWG, 105 °C, 6.3 mm OD, Cable #RF50991-*M, Flexlife           | <ol style="list-style-type: none"> <li>1. WH</li> <li>2. BN</li> <li>3. GN</li> <li>4. YE</li> <li>5. GY</li> </ol>                                  |
|                 | <b>RK 12T-*/S90</b> | <b>RS 12T-*/S90</b> | AWM TPU Grey, 12x24 AWG, 90 °C, 6 mm OD, Cable #RF50990-*M, Cut/Abrasion Immune   | <ol style="list-style-type: none"> <li>6. PK</li> <li>7. BU</li> <li>8. RD</li> <li>9. OG</li> <li>10. TN</li> <li>11. BK</li> <li>12. VT</li> </ol> |

We reserve the right to make technical alterations without prior notice.

Cordsets

\* Length in meters. Standard cable lengths are 2, 4, 6, 8 and 10 meters. Consult factory for other lengths.

\*\* Standard coupling nut material is nickel plated brass "RK .."; "RKK .." indicates nylon and "RKV .." indicates stainless steel.

## 2 and 3-Wire Cordsets, "C" Style Medium Plug Body

- NEMA 1, 3, 4, 6P
- IEC IP68 Protection
- 250 V, 4 A



| Connector Style        | Female Part Number                                     | Male Part Number                                       | Features   | Pinout  |
|------------------------|--|--|--|---|
| <p><b>RKC ..**</b></p> | <b>RKC 4.2T-*</b><br><b>WKC 4.2T-*</b>                 | <b>RSC 4.2T-*</b><br><b>WSC 4.2T-*</b>                 | ITC/PLTC PVC Yellow, 2x18 AWG, 105 °C, 6.2 mm OD, Cable #RF50511-*M, Flexlife®                     | <p><b>Female</b></p> <p>1. N/C<br/>2. N/C<br/>3. BN<br/>4. BU</p> |
| <p><b>WKC ..**</b></p> | <b>RKC 4.2T-*/CS10191</b><br><b>WKC 4.2T-*/CS10191</b> | <b>RSC 4.2T-*/CS10191</b><br><b>WSC 4.2T-*/CS10191</b> | ITC/PLTC PVC NAMUR Blue, 2x18 AWG, 105 °C, 6.2 mm OD, Cable #RF50843-*M, Flexlife, Black Plug Body |   |
| <p><b>RSC ..**</b></p> |  |  |  | <p><b>Male</b></p> <p>1. BN<br/>2. N/C<br/>3. BU<br/>4. BK</p>    |
| <p><b>WSC ..**</b></p> | <b>RKC 4T-*</b><br><b>WKC 4T-*</b>                     | <b>RSC 4T-*</b><br><b>WSC 4T-*</b>                     | ITC/PLTC PVC Yellow, 3x18 AWG, 105 °C, 6.2 mm OD, Cable #RF50513-*M, Flexlife                      |   |

We reserve the right to make technical alterations without prior notice.

\* Length in meters. Standard cable lengths are 2, 4, 6, 8 and 10 meters. Consult factory for other lengths.  
 \*\* Standard coupling nut material is nickel plated brass "RKC .."; "RKC V .." indicates stainless steel.

4-Wire Cordsets, "C" Style Medium Plug Body

- NEMA 1, 3, 4, 6P
- IEC IP68 Protection
- 250 V, 4 A



| Connector Style        | Female Part Number   | Male Part Number   | Features  | Pinout               |                                  |
|------------------------|--|--|---|----------------------|----------------------------------|
| <p><b>RKC ..**</b></p> | <b>RKC 4.4T-*</b><br><b>WKC 4.4T-*</b>                     | <b>RSC 4.4T-*</b><br><b>WSC 4.4T-*</b>                     | ITC/PLTC PVC Yellow, 4x18 AWG, 105 °C, 6.7 mm OD, Cable #RF50579-*M, Flexlife®                                | <p><b>Female</b></p> |                                  |
|                        | <b>RKC 4.4T-*/S90</b><br><b>WKC 4.4T-*/S90</b>             | <b>RSC 4.4T-*/S90</b><br><b>WSC 4.4T-*/S90</b>             | AWM TPU Yellow, 4x18 AWG, 90 °C, 7.2 mm OD, Cable #RF50544-*M, Cut/Abrasion Immune                            |                      |                                  |
| <p><b>WKC ..**</b></p> | <b>RKC 4.4T-*/S622</b><br><b>WKC 4.4T-*/S622</b>           | <b>RSC 4.4T-*/S622</b><br><b>WSC 4.4T-*/S622</b>           | ITC/PLTC PVC Grey, 4x18 AWG, 105 °C, 6.7 mm OD, Cable #RF50580-*M, Flexlife                                   |                      |                                  |
|                        | <b>RKC 4.4T-*/S824</b><br><b>WKC 4.4T-*/S824</b>           | <b>RSC 4.4T-*/S824</b><br><b>WSC 4.4T-*/S824</b>           | ITC/PLTC PVC Grey, 4x18 AWG, 105 °C, 6.7 mm OD, Cable #RF50579-*M, Tray Rated, Flexlife                       |                      |                                  |
| <p><b>RSC ..**</b></p> | <b>RKC 4.4T-*/S1587</b><br><b>WKC 4.4T-*/S1587</b>         | <b>RSC 4.4T-*/S1587</b><br><b>WSC 4.4T-*/S1587</b>         | ITC/PLTC TPE Yellow, 4x18 AWG, 105 °C, 6.9 mm OD, Cable #RF50956-*M, Weld Flash Immune, Weldlife              |                      | 1. BN<br>2. WH<br>3. BU<br>4. BK |
|                        | <b>RKC 4.4T-*/S101/S849</b><br><b>WKC 4.4T-*/S101/S849</b> | <b>RSC 4.4T-*/S101/S849</b><br><b>WSC 4.4T-*/S101/S849</b> | AWM TPE Grey, 4x22 AWG, 105 °C, 5.1 mm OD, Cable #RF50941-*M, Flexlife-20, High Flex Over 20 Million Cycles   |                      |                                  |
| <p><b>WSC ..**</b></p> | <b>RKC 4.4T-*/S101</b><br><b>WKC 4.4T-*/S101</b>           | <b>RSC 4.4T-*/S101</b><br><b>WSC 4.4T-*/S101</b>           | AWM TPE Yellow, 4x18 AWG, 105 °C, 6.2 mm OD, Cable #RF50968-*M, Flexlife-20, High Flex Over 20 Million Cycles | <p><b>Male</b></p>   |                                  |

We reserve the right to make technical alterations without prior notice.

Cordsets

\* Length in meters. Standard cable lengths are 2, 4, 5, 6, 8 and 10 meters. Consult factory for other lengths.  
 \*\* Standard coupling nut material is nickel plated brass "RKC .."; "RKC.V .." indicates stainless steel.

## 5-Wire Cordsets, "C" Style Medium Plug Body

- NEMA 1, 3, 4, 6P
- IEC IP68 Protection
- 250 V, 4 A



| Connector Style        | Female Part Number   | Male Part Number   | Features  | Pinout   |
|------------------------|--|--|---|--|
| <p><b>RKC ..**</b></p> | <p><b>RKC 4.5T-*/S653</b><br/><b>WKC 4.5T-*/S653</b></p>           | <p><b>RSC 4.5T-*/S653</b><br/><b>WSC 4.5T-*/S653</b></p>           | ITC/PLTC PVC Grey, 4x22 AWG, 105 °C, Foil/ Drain, 5.3 mm OD, Cable #RF50577-*M, RFI/EMI Shielding, Tray Rated | <ol style="list-style-type: none"> <li>1. BN</li> <li>2. WH</li> <li>3. BU</li> <li>4. BK</li> <li>5. Drain</li> </ol> |
| <p><b>WKC ..**</b></p> | <p><b>RKC 4.5T-*/S1538</b><br/><b>WKC 4.5T-*/S1538</b></p>         | <p><b>RSC 4.5T-*/S1538</b><br/><b>WSC 4.5T-*/S1538</b></p>         | ITC/PLTC PVC Grey, 5x18 AWG, 105 °C, 7.6 mm OD, Cable #RF50630-*M, Flexlife®                                  | <ol style="list-style-type: none"> <li>1. BN</li> <li>2. WH</li> <li>3. BU</li> <li>4. BK</li> <li>5. GN/YE</li> </ol> |
| <p><b>RSC ..**</b></p> | <p><b>RKC 4.5T-*/S715/S849</b><br/><b>WKC 4.5T-*/S715/S849</b></p> | <p><b>RSC 4.5T-*/S715/S849</b><br/><b>WSC 4.5T-*/S715/S849</b></p> | ITC/PLTC PVC Yellow, 5x22 AWG, 105 °C, 5.7 mm OD, Cable #RF50684-*M, Flexlife                                 | <ol style="list-style-type: none"> <li>1. BN</li> <li>2. WH</li> <li>3. BU</li> <li>4. BK</li> <li>5. GY</li> </ol>    |
| <p><b>RSC ..**</b></p> | <p><b>RKC 4.5T-*/CS10288</b><br/><b>WKC 4.5T-*/CS10288</b></p>     | <p><b>RSC 4.5T-*/CS10288</b><br/><b>WSC 4.5T-*/CS10288</b></p>     | ITC/PLTC PVC Yellow, 5x18 AWG, 105 °C, 7.6 mm OD, Cable #RF50549-*M, Flexlife                                 | <ol style="list-style-type: none"> <li>1. BN</li> <li>2. WH</li> <li>3. BU</li> <li>4. BK</li> <li>5. GN/YE</li> </ol> |
| <p><b>RSC ..**</b></p> | <p><b>RKC 4.5T-*/S1587</b><br/><b>WKC 4.5T-*/S1587</b></p>         | <p><b>RSC 4.5T-*/S1587</b><br/><b>WSC 4.5T-*/S1587</b></p>         | ITC/PLTC TPE Yellow, 5x18 AWG, 105 °C, 7.6 mm OD, Cable #RF51720-*M, Weldlife, Weld Flash Immune              | <ol style="list-style-type: none"> <li>1. BN</li> <li>2. WH</li> <li>3. BU</li> <li>4. BK</li> <li>5. GY</li> </ol>    |
| <p><b>WSC ..**</b></p> | <p><b>RKCN 5T-*</b><br/><b>WKCNC 5T-*</b></p>                      | <p><b>RSCN 5T-*</b><br/><b>WSCN 5T-*</b></p>                       | ITC/PLTC PVC NAMUR Blue, 5x22 AWG, 105 °C, 6.2 mm OD, Cable #RF50767-*M, Flexlife, for VBN 40-H1141 Multibox® | <ol style="list-style-type: none"> <li>1. GN</li> <li>2. WH</li> <li>3. OG</li> <li>4. BK</li> <li>5. RD</li> </ol>    |

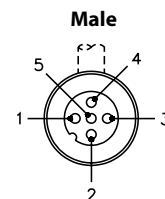
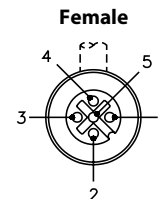

We reserve the right to make technical alterations without prior notice.

\* Length in meters. Standard cable lengths are 2, 4, 6, 8 and 10 meters. Consult factory for other lengths.

\*\* Standard coupling nut material is nickel plated brass "RKC .."; "RKCVC .." indicates stainless steel.



## 6-Wire Cordsets, "C" Style Medium Plug Body

- NEMA 1, 3, 4, 6P
- IEC IP68 Protection
- 60 VAC/75 VDC, 2 A



| Connector Style  | Female Part Number   | Male Part Number   | Features  | Pinout   |
|--|--|--|---|--|
| <p><b>RKC ..**</b><br/>1.654 [42.0]    <math>\phi</math>.589 [15.0]<br/>M12x1<br/>ANTI-VIBRATION DETENT</p> <p><b>WKC ..**</b><br/>1.736 [44.1]    1.122 [28.5]<br/><math>\phi</math>.532 [13.5]<br/>M12x1</p> <p><b>RSC ..**</b><br/>1.909 [48.5]    .531 [13.5]<br/>M12x1</p> <p><b>WSC ..**</b><br/>1.736 [44.1]    1.377 [35.0]<br/><math>\phi</math>.531 [13.5]<br/>M12x1</p> | <b>RKC 6T-*</b><br><b>WKC 6T-*</b>                         | <b>RSC 6T-*</b><br><b>WSC 6T-*</b>                         | AWM PVC Grey, 6x24 AWG, 105 °C, 5.1 mm OD, Cable #RF50608-*M, Flexlife®                                       | <p><b>Female</b></p> <p>1. BN<br/>2. WH<br/>3. BU<br/>4. BK<br/>5. GY<br/>6. PK</p> <p><b>Male</b></p> <p>1. BN<br/>2. WH<br/>3. BU<br/>4. BK<br/>5. GY<br/>6. Drain</p> |
|  | <b>RKC 6T-*/S90</b><br><b>WKC 6T-*/S90</b>                 | <b>RSC 6T-*/S90</b><br><b>WSC 6T-*/S90</b>                 | AWM TPU Grey, 6x24 AWG, 90 °C, 5.1 mm OD, Cable #RF50646-*M, Cut/Abrasion Immune                              |  |
|  | <b>RKC 6T-*/S101</b><br><b>WKC 6T-*/S101</b>               | <b>RSC 6T-*/S101</b><br><b>WSC 6T-*/S101</b>               | AWM TPE Grey, 6x24 AWG, 105 °C, 5.1 mm OD, Cable #RF50910-*M, Flexlife-20, high flex over 20 million cycles   |  |
|  | <b>RKC 6T-*/S90/S760</b><br><b>WKC 6T-*/S90/S760</b>       | <b>RSC 6T-*/S90/S760</b><br><b>WSC 6T-*/S90/S760</b>       | AWM TPU Black, 6x24 AWG, 90 °C, 5.1 mm OD, Cable #RF50728-*M, Cut/Abrasion Immune                             |  |
|  | <b>RKC 6T-*/S529</b><br><b>WKC 6T-*/S529</b>               | <b>RSC 6T-*/S529</b><br><b>WSC 6T-*/S529</b>               | AWM TPU Yellow, 6x24 AWG, 90 °C, 6.2 mm OD, Cable #RF51120-*M, Cut/Abrasion immune, braided mechanical shield |  |
|  | <b>RKC 6T-*/S849/S1052</b><br><b>WKC 6T-*/S849/S1052</b>   | <b>RSC 6T-*/S849/S1052</b><br><b>WSC 6T-*/S849/S1052</b>   | ITC/PLTC PVC Grey, 6x22 AWG, 105 °C, 6.2 mm OD, Cable #RF51284-*M, Flexlife, 22 AWG conductors, grey cable    |  |
|  | <b>RKC 6T-*/S618</b><br><b>WKC 6T-*/S618</b>               | <b>RSC 6T-*/S618</b><br><b>WSC 6T-*/S618</b>               | AWM PVC Grey, 6x24 AWG Foil/Drain, 105 °C, 5.1 mm OD, Cable #RF50610-*M, RFI/EMI Shielding                    |  |
|  | <b>RKC 6T-*/S653</b><br><b>WKC 6T-*/S653</b>               | <b>RSC 6T-*/S653</b><br><b>WSC 6T-*/S653</b>               | ITC/PLTC PVC Grey, 5x22 AWG Foil/Drain, 105 °C, 5.7 mm OD, Cable #RF50609-*M, RFI/EMI Shielding               |  |
|  | <b>RKC 6T-*/S90/CS10476</b><br><b>WKC 6T-*/S90/CS10476</b> | <b>RSC 6T-*/S90/CS10476</b><br><b>WSC 6T-*/S90/CS10476</b> | AWM TPU NAMUR Blue, 5x24 AWG Foil/Drain, 90 °C, 5.7 mm OD, Cable #RF50928-*M, Cut/Abrasion Immune             |  |

\* Length in meters. Standard cable lengths are 2, 4, 6, 8 and 10 meters. Consult factory for other lengths.

\*\* Standard coupling nut material is nickel plated brass "RKC .."; "RKC .." indicates stainless steel.

We reserve the right to make technical alterations without prior notice.

Cordsets

- NEMA 1, 3, 4, 6P
- IEC IP68 Protection
- 60 VAC/75 VDC, 2 A



| Connector Style                              | Female Part Number                             | Male Part Number   | Features  | Pinout   |
|--|--|--|---|--|
| <p><b>RKC ..**</b></p>                       | <b>RKC 8.6T-*</b><br><b>WKC 8.6T-*</b>         | <b>RSC 8.6T-*</b><br><b>WSC 8.6T-*</b>                                   | AWM PVC Black, 6x24 AWG Foil/Drain, 105 °C, 5.1 mm OD, Cable #RF50845-*M, Flexlife®, for Picofast® 4-port Multibox® | 1. WH<br>2. GN<br>3. YE<br>4. GY<br>5. BN<br>6. N/C<br>7. BU<br>8. N/C |
|  | <b>RKC 8T-*</b><br><b>WKC 8T-*</b>             | <b>RSC 8T-*</b><br><b>WSC 8T-*</b>                                       | AWM PVC Grey, 8x24 AWG, 105 °C, 5.7 mm OD, Cable #RF50753-*M, Flexlife  | <p><b>Female</b></p>   |
| <b>RKC 8T-*/S715</b><br><b>WKC 8T-*/S715</b> | <b>RSC 8T-*/S715</b><br><b>WSC 8T-*/S715</b>   | AWM PVC Yellow, 8x24 AWG, 105 °C, 5.7 mm OD, Cable #RF50884-*M, Flexlife |   |  |
| <p><b>WKC ..**</b></p>                       | <b>RKC 8T-*/S90</b><br><b>WKC 8T-*/S90</b>     | <b>RSC 8T-*/S90</b><br><b>WSC 8T-*/S90</b>                               | AWM TPU Grey, 8x24 AWG, 90 °C, 5.7 mm OD, Cable #RF50984-*M, Cut/Abrasion Immune                                    | 1. WH<br>2. BN<br>3. GN<br>4. YE<br>5. GY<br>6. PK<br>7. BU<br>8. RD   |
|  | <b>RKC 8T-*/S101</b><br><b>WKC 8T-*/S101</b>   | <b>RSC 8T-*/S101</b><br><b>WSC 8T-*/S101</b>                             | AWM TPE Grey, 8x24 AWG, 105 °C, 6.2 mm OD, Cable #RF50911-*M, Flexlife-20, High Flex Over 20 Million Cycles         |  |
| <p><b>RSC ..**</b></p>                       | <b>RKC 8T-*/S618</b><br><b>WKC 8T-*/S618</b>   | <b>RSC 8T-*/S618</b><br><b>WSC 8T-*/S618</b>                             | AWM PVC Grey, 8x24 AWG Foil/Drain, 105 °C, 5.7 mm OD, Cable #RF50815-*M, RFI/EMI Shielding                          | <p><b>Male</b></p>   |
|  | <b>RKC 8T-*/S1555</b><br><b>WKC 8T-*/S1555</b> | <b>RSC 8T-*/S1555</b><br><b>WSC 8T-*/S1555</b>                           | AWM PVC Black, 7x24 AWG Foil/Drain, 105 °C, 5.1 mm OD, Cable #RF50761-*M, RFI/EMI Shielding                         |  |
| <p><b>WSC ..**</b></p>                       | <b>RKC 8.8T-*</b><br><b>WKC 8.8T-*</b>         | <b>RSC 8.8T-*</b><br><b>WSC 8.8T-*</b>                                   | AWM PVC Grey, 8x24 AWG, 105 °C, 5.7 mm OD, Cable #RF50753-*M, Flexlife  | 1. WH<br>2. GN<br>3. YE<br>4. GY<br>5. BN<br>6. PK<br>7. BU<br>8. RD   |

We reserve the right to make technical alterations without prior notice.

\* Length in meters. Standard cable lengths are 2, 4, 6, 8 and 10 meters. Consult factory for other lengths.

\*\* Standard coupling nut material is nickel plated brass "RKC .."; "RKC .." indicates stainless steel.

## 10-Wire Cordsets, "C" Style Medium Plug Body

- NEMA 1, 3, 4, 6P
- IEC IP68 Protection
- 60 VAC/75 VDC, 2 A



| Connector Style        | Female Part Number                             | Male Part Number                               | Features  | Pinout  |
|------------------------|--|--|---|---|
| <p><b>RKC ..**</b></p> | <b>RKC 10T-*</b><br><b>WKC 10T-*</b>           | <b>RSC 10T-*</b><br><b>WSC 10T-*</b>           | AWM PVC Grey, 10x24 AWG, 105 °C, 6.2 mm OD, Cable #RF51004-*M, Flexlife®                                      | <p><b>Female</b></p> <p>1. WH<br/>2. BN<br/>3. GN<br/>4. YE<br/>5. GY<br/>6. PK<br/>7. BU<br/>8. RD<br/>9. OG<br/>10. TN</p> <p><b>Male</b></p> |
| <p><b>WKC ..**</b></p> | <b>RKC 10T-*/S90</b><br><b>WKC 10T-*/S90</b>   | <b>RSC 10T-*/S90</b><br><b>WSC 10T-*/S90</b>   | AWM TPU Grey, 10x24 AWG, 90 °C, 6.2 mm OD Cable #RF51005-*M, Cut/Abrasion Immune                              |   |
| <p><b>RSC ..**</b></p> | <b>RKC 10T-*/S101</b><br><b>WKC 10T-*/S101</b> | <b>RSC 10T-*/S101</b><br><b>WSC 10T-*/S101</b> | AWM TPE Black, 10x24 AWG, 105 °C, 7.0 mm OD, Cable #RF51077-*M, Flexlife-20, High Flex Over 20 Million Cycles |   |
| <p><b>WSC ..**</b></p> | <b>RKC 10T-*/S618</b><br><b>WKC 10T-*/S618</b> | <b>RSC 10T-*/S618</b><br><b>WSC 10T-*/S618</b> | AWM PVC Black, 10x24 AWG Foil/Drain, 105 °C, 6.6 mm OD, Cable #RF51076-*M, RFI/EMI Shielding                  |   |

We reserve the right to make technical alterations without prior notice.

\* Length in meters. Standard cable lengths are 2, 4, 6, 8 and 10 meters. Consult factory for other lengths.  
 \*\* Standard coupling nut material is nickel plated brass "RKC .."; "RKC .." indicates stainless steel.

## 12-Wire Cordsets, "C" Style Medium Plug Body

- NEMA 1, 3, 4, 6P
- IEC IP68 Protection
- 60 VAC/75 VDC, 2 A



| Connector Style        | Female Part Number                             | Male Part Number                               | Features   | Pinout  |
|------------------------|--|--|--|---|
| <p><b>RKC ..**</b></p> | <b>RKC 12T-*</b><br><b>WKC 12T-*</b>           | <b>RSC 12T-*</b><br><b>WSC 12T-*</b>           | AWM PVC Grey, 12x24 AWG, 105 °C, 6.3 mm OD, Cable #RF50991-*, Flexlife®                                      | <p><b>Female</b></p> <p>1. WH<br/>2. BN<br/>3. GN<br/>4. YE<br/>5. GY<br/>6. PK<br/>7. BU<br/>8. RD<br/>9. TN<br/>10. TN<br/>11. BK<br/>12. VT</p> <p><b>Male</b></p> |
| <p><b>WKC ..**</b></p> | <b>RKC 12T-*/S90</b><br><b>WKC 12T-*/S90</b>   | <b>RSC 12T-*/S90</b><br><b>WSC 12T-*/S90</b>   | AWM TPU Grey, 12x24 AWG, 90 °C, 6.0 mm OD, Cable #RF50990-*, Cut/Abrasion Immune                             |   |
| <p><b>RSC ..**</b></p> | <b>RKC 12T-*/S90</b><br><b>WKC 12T-*/S90</b>   | <b>RSC 12T-*/S101</b><br><b>WSC 12T-*/S101</b> | AWM TPE Black, 12x24 AWG, 105 °C, 7.6 mm OD, Cable #RF50943-*, Flexlife-20, High Flex Over 20 Million Cycles |   |
| <p><b>WSC ..**</b></p> | <b>RKC 12T-*/S618</b><br><b>WKC 12T-*/S618</b> | <b>RSC 12T-*/S618</b><br><b>WSC 12T-*/S618</b> | AWM PVC Black, 12x24 AWG Foil/Drain, 105 °C, 6.7 mm OD, Cable #RF50755-*, RFI/EMI Shielding                  |   |

We reserve the right to make technical alterations without prior notice.

\* Length in meters. Standard cable lengths are 2, 4, 6, 8 and 10 meters. Consult factory for other lengths.

\*\* Standard coupling nut material is nickel plated brass "RKC .."; "RKC V .." indicates stainless steel.

## 3 and 4-Wire Cordsets, "L" Style Compact Plug Body

- NEMA 1, 3, 4, 6P
- IEC IP68 Protection
- 250 V, 4 A



| Connector Style        | Female Part Number    | Male Part Number      | Features  | Pinout            |
|------------------------|-----------------------|-----------------------|---|-------------------|
| <p><b>RKL ..**</b></p> | <b>RKL 4-*</b>        | <b>RSL 4-*</b>        | ITC/PLTC PVC Grey, 3x22 AWG, 105 °C, 5.1 mm OD, Cable #RF52081- <i>*M</i> , Flexlife®     | <b>Female</b><br> |
|                        | <b>RKL 4-*/S90</b>    | <b>RSL 4-*/S90</b>    | AWM TPU Grey, 3x22 AWG, 90 °C, 4.8 mm OD, Cable #RF52080- <i>*M</i> , Cut/Abrasion Immune |                   |
| <p><b>RSL ..**</b></p> | <b>RKL 4.4-*</b>      | <b>RSL 4.4-*</b>      | ITC/PLTC PVC Grey, 4x22 AWG, 105 °C, 5.3 mm OD, Cable #RF50516- <i>*M</i> , Flexlife      | <b>Male</b><br>   |
|                        | <b>RKL 4.4-*/S90</b>  | <b>RSL 4.4-*/S90</b>  | AWM TPU Grey, 4x22 AWG, 90 °C, 5.1 mm OD, Cable #RF50532- <i>*M</i> , Cut/Abrasion Immune |                   |
|                        | <b>RKL 4.4-*/S715</b> | <b>RSL 4.4-*/S715</b> | ITC/PLTC PVC Yellow, 4x22 AWG, 105 °C, 5.3 mm OD, Cable #RF50530- <i>*M</i> , Flexlife    |                   |

\* Length in meters. Standard cable lengths are 2, 4, 6, 8 and 10 meters. Consult factory for other lengths.

\*\* Standard coupling nut material is nickel plated brass "RKL ..".

We reserve the right to make technical alterations without prior notice.

Cordsets

## 3 and 4-Wire Cordsets, "G" Style Large Plug Body

- NEMA 1, 3, 4, 6P
- IEC IP68 Protection
- 250 V, 4 A



| Connector Style         | Female Part Number          | Male Part Number   | Features  | Pinout                                   |
|-------------------------|-----------------------------|--|---|--|
| <p><b>RKG ..**</b></p>  | <b>RKG 4T-*</b>             | <b>RSG 4T-*</b>  | ITC/PLTC PVC Yellow, 3x18 AWG, 105 °C, 6.2 mm OD, Cable #RF50513-*M, Flexlife®, tray rated  | 1. BN<br>2. N/C<br>3. BU<br>4. BK        |
|                         | <b>RKG 4T-*/S600</b>        | <b>RSG 4T-*/S600</b>   | SJOOW, CPE Yellow, 3x18 AWG, 105 °C, 8.0 mm OD, Cable #RF50654-*M, Weld Flash Immune, Flame Resistance                              |  |
|                         | <b>RKG 4.4T-*</b>           | <b>RSG 4.4T-*</b>  | ITC/PLTC PVC Yellow, 4x18 AWG, 105 °C, 6.7 mm OD, Cable #RF50579-*M, Flexlife   | 1. BN<br>2. WH<br>3. BU<br>4. BK         |
|                         | <b>RKG 4.4T-*/S90</b>       | <b>RSG 4.4T-*/S90</b>  | AWM TPU Yellow, 4x18 AWG, 90 °C, 7.2 mm OD, Cable #RF50544-*M, Cut/Abrasion Immune  |  |
|                         | <b>RKG 4.4T-*/S101/S849</b> | <b>RSG 4.4T-*/S101/S849</b>  | AWM TPE Grey, 4x22 AWG, 105 °C, 5.1 mm OD, Cable #RF50941-*M, Flexlife-20, High Flex - Over 20 Million Cycles                       |  |
|                         | <b>RKG 4.4T-*/S101</b>      | <b>RSG 4.4T-*/S101</b>   | AWM TPE Yellow, 4x18 AWG, 105 °C, 6.2 mm OD, Cable #RF50968-*M, Flexlife-20, High Flex - Over 20 Million Cycles                     |  |
|                         | <b>RKG 4.4T-*/S529</b>      | <b>RSG 4.4T-*/S529</b>   | TPU/Heavy Braid Double Jacket Yellow, 4x20 AWG, 90 °C, 5.7 mm OD, Cable #RF50526-*M, Cut/Abrasion Immune, Braided Mechanical Shield |  |
| <b>RKG 4.4T-*/S1587</b> | <b>RSG 4.4T-*/S1587</b>     | ITC/PLTC TPE Yellow, 4x18 AWG, 105 °C, 6.9 mm OD, Cable #RF50956-*M, Weldlife, Weld Flash Immune |   |  |
| <p><b>RSG ..**</b></p>  |                             |  |   | <b>Female</b><br><br><br><b>Male</b><br> |

We reserve the right to make technical alterations without prior notice.

\* Length in meters. Standard cable lengths are 2, 4, 6, 8 and 10 meters. Consult factory for other lengths.  
 \*\* Standard coupling nut material is nickel plated brass "RKG .."; "RKGV .." indicates stainless steel.

## 4, 5 and 6-Wire Cordsets, "G" Style Large Plug Body

- NEMA 1, 3, 4, 6P
- IEC IP68 Protection
- 250 V, 4 A (4 & 5 pole)
- 60 VAC/75 VDC, 2 A (6 pole)



| Connector Style        | Female Part Number         | Male Part Number   | Features   | Pinout   |
|------------------------|----------------------------|--|--|--|
| <p><b>RKG ..**</b></p> | <b>RKG 4.4T-*/S600</b>     | <b>RSG 4.4T-*/S600</b>   | SJOOW, CPE Yellow, 4x18 AWG, 105 °C, 8.5 mm OD, Cable #RF50644-*/M, Weld Flash Immune Flame Resistance | <p><b>Female</b></p> <p>1. BN<br/>2. WH<br/>3. BU<br/>4. BK</p> <p><b>Male</b></p>                     |
|                        | <b>RKG 4.5T-*</b>          | <b>RSG 4.5T-*</b>  | ITC/PLTC PVC Grey, 5x22 AWG, 105 °C, 5.7 mm OD, Cable #RF50543-*/M, Flexlife®                          | <p><b>Female</b></p> <p>1. BN<br/>2. WH<br/>3. BU<br/>4. BK<br/>5. GY</p> <p><b>Male</b></p>           |
|                        | <b>RKG 4.5T-*/S90/S715</b> | <b>RSG 4.5T-*/S90/S715</b>   | AWM TPU Yellow, 5x18 AWG, 90 °C, 7.2 mm OD, Cable #RF50751-*/M, Cut/Abrasion Immune                    | <p><b>Female</b></p> <p>1. BN<br/>2. WH<br/>3. BU<br/>4. BK<br/>5. GN/YE</p> <p><b>Male</b></p>        |
| <b>RKG 4.5T-*/S600</b> | <b>RSG 4.5T-*/S600</b>     | SJOOW CPE Yellow, 5x18 AWG, 105 °C, 9.4 mm OD, Cable #RF50937-*/M, Weld Flash Immune, Flame Resistance | <p><b>Female</b></p> <p>1. BN<br/>2. WH<br/>3. BU<br/>4. BK<br/>5. GY</p>                              |  |
| <p><b>RSG ..**</b></p> | <b>RKG 6T-*</b>            | <b>RSG 6T-*</b>  | AWM PVC Grey, 6x24 AWG, 105 °C, 5.1 mm OD, Cable #RF50608-*/M, Flexlife                                | <p><b>Female</b></p> <p>1. BN<br/>2. WH<br/>3. BU<br/>4. BK<br/>5. GY<br/>6. PK</p> <p><b>Male</b></p> |
|                        | <b>RKG 6T-*/S90</b>        | <b>RSG 6T-*/S90</b>  | AWM TPU Grey, 6x24 AWG, 90 °C, 5.1 mm OD, Cable #RF50646-*/M, Cut/Abrasion Immune                      |  |

We reserve the right to make technical alterations without prior notice.

\* Length in meters. Standard cable lengths are 2, 4, 6, 8 and 10 meters. Consult factory for other lengths.

\*\* Standard coupling nut material is nickel plated brass "RKG .."; "RKGV .." indicates stainless steel.

## 8, 10 and 12-Wire Cordsets, "G" Style Large Plug Body

- NEMA 1, 3, 4, 6P
- IEC IP68 Protection
- 60 VAC/75 VDC, 2 A



| Connector Style | Female Part Number    | Male Part Number      | Features   | Pinout   |
|-----------------|-----------------------|-----------------------|--|--|
| <p>RKG ..**</p> | <b>RKG 8T-*</b>       | <b>RSG 8T-*</b>       | AWM PVC Grey, 8x24 AWG, 105 °C, 5.7 mm OD, Cable #RF50753-*M, Flexlife®, CSA Approved          | <p><b>Female</b></p> <p>1. WH<br/>2. BN<br/>3. GN<br/>4. YE<br/>5. GY<br/>6. PK<br/>7. BU<br/>8. RD</p> <p><b>Male</b></p> |
|                 | <b>RKG 8T-*/S90</b>   | <b>RSG 8T-*/S90</b>   | AWM TPU Grey, 8x24 AWG, 90 °C, 5.7 mm OD, Cable #RF50984-*M, Cut/Abrasion Immune, CSA Approved | <p><b>Female</b></p> <p><b>Male</b></p>  |
|                 | <b>RKG 10T-*</b>      | <b>RSG 10T-*</b>      | AWM PVC Grey, 10x24 AWG, 105 °C, 6.2 mm OD, Cable #RF51004-*M, Flexlife                        | <p><b>Female</b></p> <p>1. WH<br/>2. BN<br/>3. GN<br/>4. YE<br/>5. GY<br/>6. PK<br/>7. BU<br/>8. RD</p> <p><b>Male</b></p> |
|                 | <b>RKG 10T-*/S618</b> | <b>RSG 10T-*/S618</b> | AWM PVC Black, 10x24 AWG, Foil/Drain, 105 °C, 6.6 mm OD, Cable #RF51076-*M, RFI/EMI shielding  | <p><b>Female</b></p> <p>9. OG<br/>10. TN</p> <p><b>Male</b></p>  |
|                 | <b>RKG 12T-*</b>      | <b>RSG 12T-*</b>      | AWM PVC Grey, 12x24 AWG, 105 °C, 6.3 mm OD, Cable #RF50991-*M, Flexlife                        | <p><b>Female</b></p> <p>1. WH<br/>2. BN<br/>3. GN<br/>4. YE<br/>5. GY<br/>6. PK<br/>7. BU<br/>8. RD</p> <p><b>Male</b></p> |
|                 | <b>RKG 12T-*/S618</b> | <b>RSG 12T-*/S618</b> | AWM PVC Black, 12x24 AWG, Foil/Drain, 105 °C, 6.7 mm OD, Cable #RF50755-*M, RFI/EMI shielding  | <p><b>Female</b></p> <p>9. OG<br/>10. TN<br/>11. BK<br/>12. VT</p> <p><b>Male</b></p>                                      |

We reserve the right to make technical alterations without prior notice.

\* Length in meters. Standard cable lengths are 2, 4, 6, 8 and 10 meters. Consult factory for other lengths.

\*\* Standard coupling nut material is nickel plated brass "RKG .."; "RKGV .." indicates stainless steel.



3, 4 and 5-Wire Cordsets, "A" Style Extreme Duty Armored Plug Body - 18 AWG

- Shield to Coupling Nut
- NEMA 1, 3, 4, 6P and IEC IP68 Protection
- 250 V, 4 A

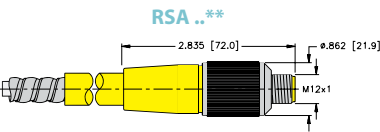
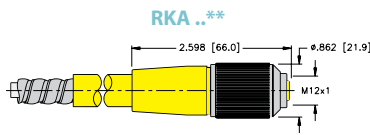

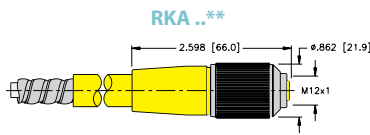
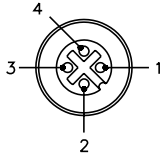
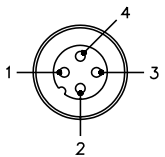
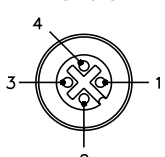
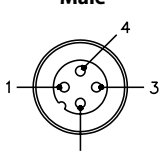
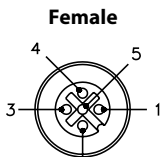
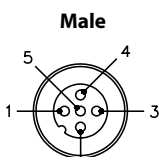
| Connector Style   | Female Part Number | Male Part Number  | Features  | Pinout  |
|---|--------------------|-------------------|---|---|
|  | <b>RKA 4A-*</b>    | <b>RSA 4A-*</b>   | Interlock Al Armor, ITC-ER/PLTC-ER, PVC Yellow, 3x18 AWG, 105 °C, 14.9 mm OD, Cable #RF51040-*M, Extreme Duty Armored Cable, Tray Rated | <p><b>Female</b></p>  <p><b>Male</b></p>      |
|   | <b>RKA 4.4A-*</b>  | <b>RSA 4.4A-*</b> | Interlock Al Armor, ITC-ER/PLTC-ER, PVC Yellow, 4x18 AWG, 105 °C, 15.2 mm OD, Cable #RF51041-*M, Extreme Duty Armored Cable, Tray Rated | <p><b>Female</b></p>  <p><b>Male</b></p>   |
|   | <b>RKA 4.5A-*</b>  | <b>RSA 4.5A-*</b> | Interlock Al Armor, MC PVC Yellow, 5x18 AWG, 90 °C, 14.9 mm OD, Cable #RF51042-*M, Extreme Duty Armored Cable                           | <p><b>Female</b></p>  <p><b>Male</b></p>  |

We reserve the right to make technical alterations without prior notice.

Cordsets

\* Length in meters. Standard cable lengths are 2, 4, 6, 8 and 10 meters. Consult factory for other lengths.  
 \*\* Standard coupling nut material is nickel plated brass "RKA .."; "RKAV .." indicates stainless steel.

- Shield to Coupling Nut
- IEC IP 67 Protection
- 250 V, 4 A (4 & 5 pole)
- 60 VAC/75 VDC, 2 A (6 pole)



| Connector Style        | Female Part Number                               | Male Part Number                                 | Features   | Pinout                                  |
|------------------------|--|--|--|---|
| <p><b>RKS ..**</b></p> | <b>RKS 4.4T-*</b><br><b>WKS 4.4T-*</b>           | <b>RSS 4.4T-*</b><br><b>WSS 4.4T-*</b>           | ITC/PLTC PVC Grey, 4x22 AWG, 105 °C, 6.2 mm OD, Cable #RF50729-*M, RFI/EMI shielding, Tray rated | <p><b>Female</b></p> <p><b>Male</b></p> |
|                        | <b>RKS 4.4T-*/S90</b><br><b>WKS 4.4T-*/S90</b>   | <b>RSS 4.4T-*/S90</b><br><b>WSS 4.4T-*/S90</b>   | AWM TPU Grey, 4x22 AWG, 90 °C, 6.2 mm OD, Cable #RF50810-*M, RFI/EMI shielding                   |   |
|                        | <b>RKS 4.4T-*/S824</b><br><b>WKS 4.4T-*/S824</b> | <b>RSS 4.4T-*/S824</b><br><b>WSS 4.4T-*/S824</b> | ITC/PLTC PVC Grey, 4x22 AWG, 105 °C, 6.2 mm OD, Cable #RF50729-*M, RFI/EMI shielding, Tray rated |   |
| <p><b>WKS ..**</b></p> | <b>RKS 4.5T-*</b><br><b>WKS 4.5T-*</b>           | <b>RSS 4.5T-*</b><br><b>WSS 4.5T-*</b>           | ITC/PLTC PVC Grey, 5x22 AWG, 105 °C, 6.6 mm OD, Cable #RF50713-*M, RFI/EMI shielding, Tray rated | <p><b>Female</b></p> <p><b>Male</b></p> |
|                        |  |  |  |   |
| <p><b>RSS ..**</b></p> |  |  |  | <p><b>Female</b></p> <p><b>Male</b></p> |
|                        | <b>RKS 6T-*</b><br><b>WKS 6T-*</b>               | <b>RSS 6T-*</b><br><b>WSS 6T-*</b>               | AWM PVC Grey, 6x24 AWG, 105 °C, 6.6 mm OD, Cable #RF50814-*M, RFI/EMI shielding                  |   |
| <p><b>WSS ..**</b></p> |  |  |  |   |

We reserve the right to make technical alterations without prior notice.

\* Length in meters. Standard cable lengths are 2, 4, 6, 8 and 10 meters. Consult factory for other lengths.

\*\* Standard coupling nut material is nickel plated brass "RKS .."; "RKS .." indicates stainless steel.

## 8, 10 and 12-Wire Cordsets, "S" Style, Shielded

- Shield to Coupling Nut
- IEC IP 67 Protection
- 60 VAC/75 VDC, 2 A



We reserve the right to make technical alterations without prior notice.

| Connector Style        | Female Part Number                   | Male Part Number                     | Features  | Pinout                                  |
|------------------------|--------------------------------------|--------------------------------------|---|---|
| <p><b>RKS ..**</b></p> | <b>RKS 8T-*</b><br><b>WKS 8T-*</b>   | <b>RSS 8T-*</b><br><b>WSS 8T-*</b>   | AWM PVC Grey, 8x24 AWG, 105 °C, 7.2 mm OD, Cable #RF50813-*M, RFI/EMI shielding, CSA Approved | <p><b>Female</b></p> <p><b>Male</b></p> |
| <p><b>WKS ..**</b></p> | <b>RKS 10T-*</b><br><b>WKS 10T-*</b> | <b>RSS 10T-*</b><br><b>WSS 10T-*</b> | AWM PVC Grey, 10x24 AWG, 105 °C, 7.2 mm OD, Cable #RF51006-*M, RFI/EMI shielding              | <p><b>Female</b></p> <p><b>Male</b></p> |
| <p><b>RSS ..**</b></p> | <b>RKS 12T-*</b><br><b>WKS 12T-*</b> | <b>RSS 12T-*</b><br><b>WSS 12T-*</b> | AWM PVC Grey, 12x24 AWG, 105 °C, 7.2 mm OD, Cable #RF50988-*M, RFI/EMI shielding              | <p><b>Female</b></p> <p><b>Male</b></p> |

\* Length in meters. Standard cable lengths are 2, 4, 6, 8 and 10 meters. Consult factory for other lengths.

\*\* Standard coupling nut material is nickel plated brass "RKS .."; "RKS SV .." indicates stainless steel.

Cordsets

## 3-Wire Cordsets with LEDs

- NEMA 1, 3, 4, 6P
- IEC IP68 Protection
- 10-30 VDC, 4 A



| Connector Style  | Female Part Number                                    | Male Part Number          | Features   | Pinout               |
|--|---|---------------------------|--|----------------------|
| <p><b>RKE ..**</b></p>   | <b>RKE 4T-*-P7X2</b><br><b>WK 4T-*-P7X2</b>           | <b>RSE 4T-*-P7X2</b>      | ITC/PLTC PVC Grey, 3x22 AWG, 105 °C, 5.1 mm OD, Cable #RF52081-*-M, PNP Signal, Flexlife®                                  | <p><b>Female</b></p> |
|  | <b>RKE 4T-*-N7X2</b><br><b>WK 4T-*-N7X2</b>           |                           | ITC/PLTC PVC Grey, 3x22 AWG, 105 °C, 5.1 mm OD, Cable #RF52081-*-M, NPN Signal, Flexlife                                   |                      |
|  | <b>RKE 4T-*-P7X2/S90</b><br><b>WK 4T-*-P7X2/S90</b>   | <b>RSE 4T-*-P7X2/S90</b>  | AWM TPU Grey, 3x22 AWG, 90 °C, 4.8 mm OD, Cable #RF52080-*-M, PNP Signal, Cut/Abrasion Immune                              |                      |
|  | <b>RKE 4T-*-N7X2/S90</b><br><b>WK 4T-*-N7X2/S90</b>   |                           | AWM TPU Grey, 3x22 AWG, 90 °C, 4.8 mm OD, Cable #RF52080-*-M, NPN Signal, Cut/Abrasion Immune                              |                      |
|  | <b>WK 4T-*-P7X2/S101</b>                              |                           | AWM TPE Grey, 3x22 AWG, 105 °C, 4.8 mm OD, Cable #RF52085-*-M, PNP Signal, Flexlife-20, High Flex - Over 20 Million Cycles |                      |
|  | <b>WK 4T-*-N7X2/S101</b>                              |                           | AWM TPE Grey, 3x22 AWG, 105 °C, 4.8 mm OD, Cable #RF52085-*-M, NPN Signal, Flexlife-20, High Flex - Over 20 Million Cycles |                      |
|  | <b>WK 4T-*-P7X2/S618</b>                              |                           | ITC/PLTC PVC Grey, 3x22 AWG, 105 °C, 5.1 mm OD, Cable #RF52082-*-M, PNP Signal, EMI/RFI Protection                         |                      |
|  | <b>WK 4T-*-N7X2/S618</b>                              |                           | ITC/PLTC PVC Grey, 3x22 AWG, 105 °C, 5.1 mm OD, Cable #RF52082-*-M, NPN Signal, EMI/RFI Protection                         |                      |
|  | <b>RKE 4T-*-P7X2/S715</b><br><b>WK 4T-*-P7X2/S715</b> | <b>RSE 4T-*-P7X2/S715</b> | ITC/PLTC PVC Yellow, 3x22 AWG, 105 °C, 5.1 mm OD, Cable #RF52087-*-M, PNP Signal, Flexlife                                 |                      |
|  | <b>RKE 4T-*-N7X2/S715</b><br><b>WK 4T-*-N7X2/S715</b> |                           | ITC/PLTC PVC Yellow, 3x22 AWG, 105 °C, 5.1 mm OD, Cable #RF52087-*-M, NPN Signal, Flexlife                                 |                      |
| <p><b>WK ..**</b></p> <p>Output (Yellow)<br/>Power (Green)</p> | <b>RKE 4T-*-P7X2/S824</b><br><b>WK 4T-*-P7X2/S824</b> | <b>RSE 4T-*-P7X2/S824</b> | ITC/PLTC PVC Grey, 3x22 AWG, 105 °C, 5.1 mm OD, Cable #RF52081-*-M, PNP Signal, Tray Rated, Flexlife                       | <p><b>Male</b></p>   |
|  | <b>RKE 4T-*-N7X2/S824</b><br><b>WK 4T-*-N7X2/S824</b> |                           | ITC/PLTC PVC Grey, 3x22 AWG, 105 °C, 5.1 mm OD, Cable #RF52081-*-M, NPN Signal, Tray Rated, Flexlife                       |                      |

We reserve the right to make technical alterations without prior notice.

\* Length in meters. Standard cable lengths are 2, 4, 6, 8 and 10 meters. Consult factory for other lengths.

\*\* Standard coupling nut material is nickel plated brass "RKE..".

## 4-Wire Cordsets with LEDs

- NEMA 1, 3, 4, 6P
- IEC IP68 Protection
- 10-30 VDC, 4 A



| Connector Style  | Female Part Number  | Male Part Number            | Features  | Pinout   |
|--|---|-----------------------------|---|--|
| <p><b>RKE ..**</b></p> <p>1.807 [45.9]    <math>\phi</math>.532 [13.5]</p> <p>M12x1</p> <p>LED 4x</p> <p><b>WK ..**</b></p> <p>Output (Yellow)</p> <p>Power (Green)</p> <p>1.700 [43.2]    LED 2x</p> <p>1.142 [29.0]</p> <p><math>\phi</math>.551 [14.0]    M12x1</p> <p><b>RSE ..**</b></p> <p>2.173 [55.2]    <math>\phi</math>.531 [13.5]</p> <p>M12x1</p> <p>LED 4x</p> | <b>RKE 4.4T-*-P7X2</b><br><b>WK 4.4T-*-P7X2</b>           | <b>RSE 4.4T-*-P7X2</b>      | ITC/PLTC PVC Grey, 4x22 AWG, 105 °C, 5.3 mm OD, Cable #RF50516-*M, PNP Signal, Flexlife®                                  | <p><b>Female</b></p> <p>1. BN<br/>2. WH<br/>3. BU<br/>4. BK</p> <p><b>Male</b></p> |
|  | <b>RKE 4.4T-*-N7X2</b><br><b>WK 4.4T-*-N7X2</b>           | <b>RSE 4.4T-*-N7X2</b>      | ITC/PLTC PVC Grey, 4x22 AWG, 105 °C, 5.3 mm OD Cable #RF50516-*M NPN Signal, Flexlife                                     |  |
|  | <b>RKE 4.4T-*-P7X2/S90</b><br><b>WK 4.4T-*-P7X2/S90</b>   | <b>RSE 4.4T-*-P7X2/S90</b>  | ITC/PLTC PVC Grey, 4x22 AWG, 105 °C, 5.3 mm OD, Cable #RF50516-*M, PNP Signal, Flexlife                                   |  |
|  | <b>WK 4.4T-*-N7X2/S90</b>                                 |                             | ITC/PLTC PVC Grey, 4x22 AWG, 105 °C, 5.3 mm OD, Cable #RF50516-*M, NPN Signal, Flexlife                                   |  |
|  | <b>RKE 4.4T-*-P7X2/S101</b><br><b>WK 4.4T-*-P7X2/S101</b> | <b>RSE 4.4T-*-P7X2/S101</b> | AWM TPE Grey, 4x22 AWG, 105 °C, 5.1 mm OD, Cable #RF50941-*M, PNP Signal, Flexlife-20, High Flex - Over 20 Million Cycles |  |
|  | <b>WK 4.4T-*-N7X2/S101</b>                                |                             | AWM TPE Grey, 4x22 AWG, 105 °C, 5.1 mm OD, Cable #RF50941-*M, NPN Signal, Flexlife-20, High Flex - Over 20 Million Cycles |  |

We reserve the right to make technical alterations without prior notice.

\* Length in meters. Standard cable lengths are 2, 4, 6, 8 and 10 meters. Consult factory for other lengths.

\*\* Standard coupling nut material is nickel plated brass "RKE ..".

## 4 and 5-Wire Cordsets with LEDs

- NEMA 1, 3, 4, 6P
- IEC IP68 Protection
- 10-30 VDC, 4 A



| Connector Style        | Female Part Number         | Features  | Pinout               |
|------------------------|----------------------------|---|----------------------|
| <p><b>RKE ..**</b></p> | <b>WK 4.4T-*-P7X2/S618</b> | ITC/PLTC PVC Grey, 4x22 AWG, 105 °C, 5.3 mm OD, Cable #RF50577-*M, PNP Signal, EMI/RFI Protection | <p><b>Female</b></p> |
|                        | <b>WK 4.4T-*-N7X2/S618</b> | ITC/PLTC PVC Grey, 4x22 AWG, 105 °C, 5.3 mm OD, Cable #RF50577-*M, NPN Signal, EMI/RFI Protection |                      |
| <p><b>WK ..**</b></p>  | <b>WK 4.4T-*-P7X2/S824</b> | ITC/PLTC PVC Grey, 4x22 AWG, 105 °C, 5.3 mm OD, Cable #RF50698-*M, PNP Signal, Tray Rated         | <p><b>Female</b></p> |
|                        | <b>WK 4.4T-*-P7X2/S824</b> | ITC/PLTC PVC Grey, 4x22 AWG, 105 °C, 5.1 mm OD, Cable #RF50698-*M, NPN Signal, Tray Rated         |                      |
|                        | <b>WK 4.5T-*-P7X2</b>      | ITC/PLTC PVC Grey, 5x22 AWG, 105 °C, 5.7 mm OD, Cable #RF50543-*M, PNP Signal, Flexlife®          |                      |
|                        | <b>RKE 4.5T-*-P7X2</b>     | ITC/PLTC PVC Grey, 5x22 AWG, 105 °C, 5.7 mm OD, Cable #RF50543-*M, PNP Signal, Flexlife           |                      |

\* Length in meters. Standard cable lengths are 2, 4, 6, 8 and 10 meters. Consult factory for other lengths.

\*\* Standard coupling nut material is nickel plated brass "WK .."; "WKV .." Indicates stainless steel.

We reserve the right to make technical alterations without prior notice.

## 4 and 5-Wire Cordsets with LEDs

- NEMA 1, 3, 4, 6P
- IEC IP68 Protection
- 10-30 VDC, 4 A



| Connector Style   | Female Part Number         | Features  | Pinout               |
|---|----------------------------|---|----------------------|
| <p><b>WK ..**</b></p> <p>Output (Yellow)</p> <p>Output (Yellow)</p> <p>Power (Green)</p> <p>LED 3x</p> <p>1.700 [43.2]</p> <p>1.142 [29.0]</p> <p>ø.551 [14.0]</p> <p>M12x1</p> | <b>WK 4.4T-*-P7X3</b>      | ITC/PLTC PVC Grey, 4x22 AWG, 105 °C, 5.3 mm OD, Cable #RF50516-*M, PNP Signal, Flexlife®                                  | <p><b>Female</b></p> |
|   | <b>WK 4.4T-*-P7X3/S90</b>  | AWM TPU Grey, 4x22 AWG, 90 °C, 5.1 mm OD, Cable #RF50532-*M, PNP Signal, Cut/Abrasion Immune                              |                      |
|   | <b>WK 4.4T-*-P7X3/S101</b> | AWM TPE Grey, 4x22 AWG, 105 °C, 5.1 mm OD, Cable #RF50941-*M, PNP Signal, Flexlife-20, High Flex - Over 20 Million Cycles |                      |

\* Length in meters. Standard cable lengths are 2, 4, 6, 8 and 10 meters. Consult factory for other lengths.  
 \*\* Standard coupling nut material is nickel plated brass "WK.."; "WKV.." Indicates stainless steel.

We reserve the right to make technical alterations without prior notice.

Cordsets

### LED Diagrams

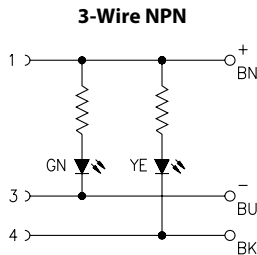

1. + Voltage (Green LED)
2. N/C
3. Common
4. Output (Yellow LED)

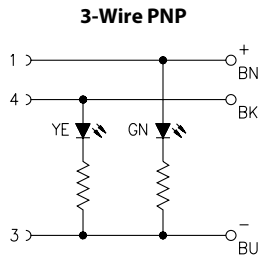

1. + Voltage (Green LED)
2. NC
3. Common
4. Output (Yellow LED)

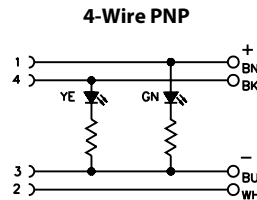

1. + Voltage (Green LED)
2. Output
3. Common
4. Output (Yellow LED)

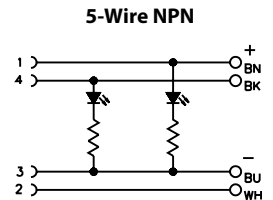

1. + Voltage (Green LED)
2. Output
3. Common
4. Output (Yellow LED)
5. Ground

## 3 and 4-Wire Cordsets with and without LEDs, Rubber

- NEMA 1, 3, 4, 6P
- IEC IP68 Protection
- 10-30 VDC, 4 A



| Connector Style        | Female Part Number                 | Features   | Pinout               |
|------------------------|------------------------------------|--|----------------------|
| <p><b>WKE ..**</b></p> | <p><b>WKE 4T-*-P7X2/S600</b></p>   | <p>SJOOW CPE Yellow 3x18 AWG, 105 °C 8.0 mm OD, Cable #RF50654-*M, PNP Signal, Weld Flash Immune, Flame Immune</p>   | <p><b>Female</b></p> |
|                        | <p><b>WKE 4T-*-N7X2/S600</b></p>   | <p>SJOOW CPE Yellow 3x18 AWG, 105 °C, 8.0 mm OD, Cable #RF50654-*M, NPN Signal, Weld Flash Immune, Flame Immune</p>  |                      |
| <p><b>WKE ..**</b></p> | <p><b>WKE 4.4T-2-P7X3/S600</b></p> | <p>SJOOW CPE Yellow, 4x18 AWG, 105 °C, 8.5 mm OD, Cable #RF50644-*M, PNP Signal, Weld Flash Immune, Flame Immune</p> | <p><b>Female</b></p> |

\* Length in meters. Standard cable lengths are 2, 4, 6, 8 and 10 meters. Consult factory for other lengths.

\*\* Standard coupling nut material is nickel plated brass.

We reserve the right to make technical alterations without prior notice.



8-Pin Cordset with LEDs

- NEMA 1, 3, 4, 6P
- IEC IP68 Protection
- 5-30 VDC



| Connector Style         | Female Part Number               | Features   | Pinout  |
|-------------------------|----------------------------------|--|---|
| <p><b>E-WK ..**</b></p> | <p><b>E-WKC 8T-PX3-930-*</b></p> | <p>AWM PVC, Black, 8x24 AWG, 105 °C, 7.2 mm OD, Cable #RF50930-*M, 3 indicator LEDs in translucent molded connector-for use with Kübler Incremental Encoders</p> | <p><b>Female</b></p> <p>1. WH<br/>2. BN<br/>3. GN<br/>4. YE<br/>5. GY<br/>6. PK<br/>7. BU<br/>8. RD</p> |

Cordsets

We reserve the right to make technical alterations without prior notice.

- \* Length in meters. Standard cable lengths are 2, 4, 6, 8 and 10 meters.
- \*\* Standard coupling nut material is nickel plated brass "WKC.."; "WKC.." indicates stainless steel.

Wiring Diagram

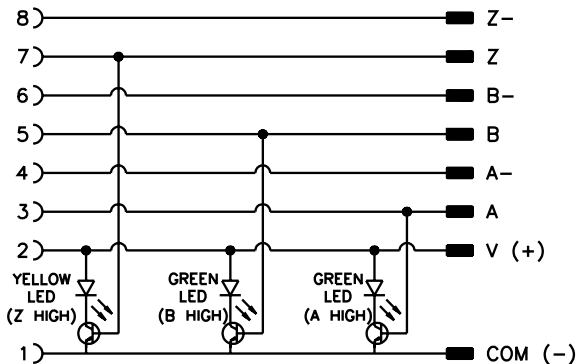

8-Pin Cordset with Encoder



Note: LEDs for indication of channels A, B and Z. Green LEDs indicate channels A and B, while amber is used for the index channel. LEDs can also be used during machine set-up for home position indication, and provide operational status of encoder output channels.

## 3 and 5-Wire Cordsets, Reverse Key (B-Code)

- NEMA 1, 3, 4, 6P
- IEC IP68 Protection
- 250 V, 4 A



| Connector Style   | Female Part Number  | Male Part Number  | Features   | Pinout  |
|---|---|---|--|---|
| <p><b>WAKW ..**</b></p>                                     | <p><b>WAKW 4T-*/S626</b><br/><b>WWAKW 4T-*/S626</b></p>     | <p><b>WASW 4T-*/S626</b><br/><b>WWASW 4T-*/S626</b></p>   | <p>ITC/PLTC PVC Grey, 3x20 AWG, 105 °C, 5.3 mm OD, Cable #RF51926-*M, Flexlife®</p>                                  | <p>1. BN<br/>2. BU<br/>4. GN/YE</p>                     |
| <p><b>WWAKW ..**</b></p>                                    | <p><b>WAKW 4.5T-*</b><br/><b>WWAKW 4.5T-*</b></p>           | <p><b>WASW 4.5T-*</b><br/><b>WWASW 4.5T-*</b></p>   | <p>ITC/PLTC PVC Grey, 4x22, 1x20 AWG, 105 °C, 6.0 mm OD, Cable #RF50563-*M, Flexlife</p>                             | <p>1. BN<br/>2. WH<br/>3. BU<br/>4. BK<br/>5. GN/YE</p> |
| <p><b>WASW ..**</b></p>                                     | <p><b>WAKW 4.5T-*/S101</b><br/><b>WWAKW 4.5T-*/S101</b></p> | <p><b>WASW 4.5T-*/S101</b><br/><b>WWASW 4.5T-*/S101</b></p>   | <p>AWM TPE Grey, 5x22 AWG, 105 °C, 5.7 mm OD, Cable #RF50909-*M, Flexlife-20, High Flex - Over 20 Million Cycles</p> | <p>1. BN<br/>2. WH<br/>3. BU<br/>4. BK<br/>5. GY</p>    |
| <p><b>WWASW ..**</b></p>                                    | <p><b>WAKW 4.5T-*/S618</b><br/><b>WWAKW 4.5T-*/S618</b></p> | <p><b>WASW 4.5T-*/S618</b><br/><b>WWASW 4.5T-*/S618</b></p>   | <p>ITC/PLTC PVC Grey, 5x22 AWG Foil/Drain, 105 °C, 5.7 mm OD, Cable #RF50609-*M, EMI/RFI Protection</p>              | <p>1. BN<br/>2. WH<br/>3. BU<br/>4. BK<br/>5. Drain</p> |
| <p><b>WAKW 4.5T-*/S653</b><br/><b>WWAKW 4.5T-*/S653</b></p> | <p><b>WASW 4.5T-*/S653</b><br/><b>WWASW 4.5T-*/S653</b></p> | <p>ITC/PLTC PVC Grey, 4x22 AWG Foil/Drain, 105 °C, 5.3 mm OD, Cable #RF50577-*M, EMI/RFI Protection</p> | <p>1. BN<br/>2. WH<br/>3. BU<br/>4. BK<br/>5. Drain</p>  |   |



We reserve the right to make technical alterations without prior notice.

\* Length in meters. Standard cable lengths are 2, 4, 6, 8 and 10 meters. Consult factory for other lengths.

\*\* Standard coupling nut material is nickel plated brass "WAKW.."; "WAKKW.." indicates nylon and "WAKVW.." indicates stainless steel.

## Spiral Cordsets, Standard Plug Body

- NEMA 1, 3, 4, 6P
- IEC IP68 Protection
- 250 V, 4 A



| Connector Style           | Female Part Number   | Features  | Pinout                                    |
|---------------------------|--|---|---|
| <p><b>RK ...-SP**</b></p> | <b>RK 4T-3.3/S90-SP</b><br><b>WK 4T-3.3/S90-SP</b>           | AWM TPU Grey, 3x22 AWG, 90 °C, 5.1 mm OD, for repetitive motion 3-wire DC applications  | 1. BN<br>3. BU<br>4. BK                   |
|                           | <b>RK 4.4T-3.3/S90-SP</b><br><b>WK 4.4T-3.3/S90-SP</b>       | AWM TPU Grey, 4x22 AWG, 90 °C, 5.1 mm OD, for repetitive motion 4-wire DC applications  | 1. BN<br>2. WH<br>3. BU<br>4. BK          |
| <p><b>WK ...-SP**</b></p> | <b>RK 4.4T-3/S90-SP/S669</b><br><b>WK 4.4T-3/S90-SP/S669</b> | AWM TPU Black, 4x26 AWG, 90 °C, 4.2 mm OD, for repetitive motion, 4-wire DC applications, Eurofast connector with Picofast® coil cord | 1. BN<br>2. WH<br>3. BU<br>4. BK          |
|                           | <b>RK 4.5T-3.3/S90-SP</b><br><b>WK 4.5T-3.3/S90-SP</b>       | AWM TPU Grey, 5x22 AWG, 90 °C, 5.3 mm OD, for repetitive motion 5-wire DC applications  | 1. BN<br>2. WH<br>3. BU<br>4. BK<br>5. GY |

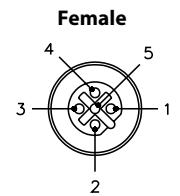
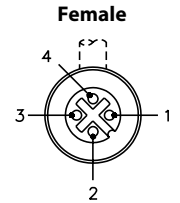

Cordsets

We reserve the right to make technical alterations without prior notice.

\* Length in meters. Standard cable length is 3.3 meters (Picofast coil standard is 3 meters). Consult factory for other lengths.  
 \*\* Standard coupling nut material is nickel plated brass .. "RK(WK).."; "RKK(WKK).." indicates nylon and "RKV(WKV)" indicates 316 stainless steel.

## Spiral Cordsets, Standard Plug Body

- NEMA 1, 3, 4, 6P
- IEC IP68 Protection
- 250 V, 4 A



| Connector Style          | Female Part Number   | Features   | Pinout                                    |
|--------------------------|--|--|---|
| <p><b>RS ..-SP**</b></p> | <b>RS 4T-3.3/S90-SP</b><br><b>WS 4T-3.3/S90-SP</b>           | AWM TPU Grey, 3x22 AWG, 90 °C, 5.1 mm OD, for repetitive motion 3-wire DC applications   | 1. BN<br>3. BU<br>4. BK                   |
|                          | <b>RS 4.4T-3.3/S90-SP</b><br><b>WS 4.4T-3.3/S90-SP</b>       | AWM TPU Grey, 4x22 AWG, 90 °C, 5.1 mm OD, for repetitive motion 4-wire DC applications   | 1. BN<br>2. WH<br>3. BU<br>4. BK          |
| <p><b>WS ..-SP**</b></p> | <b>RS 4.4T-3/S90-SP/S669</b><br><b>WS 4.4T-3/S90-SP/S669</b> | AWM TPU Black, 4x26 AWG, 90 °C, 4.2 mm OD, for repetitive motion 4-wire DC applications, Eurofast connector with Picofast® coil cord | 1. BN<br>2. WH<br>3. BU<br>4. BK          |
|                          | <b>RS 4.5T-3.3/S90-SP</b><br><b>WS 4.5T-3.3/S90-SP</b>       | AWM TPU Grey, 5x22 AWG, 90 °C, 5.3 mm OD, for repetitive motion 5-wire DC applications   | 1. BN<br>2. WH<br>3. BU<br>4. BK<br>5. GY |

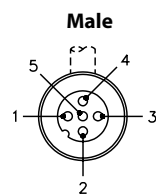
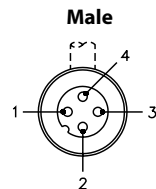

\* Length in meters. Standard cable length is 3.3 meters (Picofast coil standard is 3 meters). Consult factory for other lengths.

\*\* Standard coupling nut material is nickel plated brass.. "RS (WS).."; "RSK (WSK).." indicates nylon and "RSV (WSV)" indicates stainless steel.

We reserve the right to make technical alterations without prior notice.

Spiral Cordsets, "C" Style Medium Plug Body

- NEMA 1, 3, 4, 6P
- IEC IP68 Protection
- 60 VAC/75 VDC, 2A



| Connector Style           | Female Part Number  | Features   | Pinout               |
|---------------------------|---|--|----------------------|
| <p><b>RKC ..-SP**</b></p> | <p><b>RKC 6T-3.3/S90-SP</b><br/> <b>WKC 6T-3.3/S90-SP</b></p>                     | <p>AWM TPU Black, 6x24 AWG, 90 °C,<br/>                     5.1 mm OD, for repetitive motion<br/>                     6-wire DC applications</p> | <p><b>Female</b></p> |
| <p><b>WK ..-SP**</b></p>  | <p><b>RKC 8.6T-3.3/S90-SP/CS10451</b><br/> <b>WKC 8.6T-3.3/S90-SP/CS10451</b></p> | <p>AWM TPU Black, 6x24 AWG, 90 °C,<br/>                     5.1 mm OD, for repetitive motion<br/>                     6-wire DC applications</p> | <p><b>Female</b></p> |

\* Length in meters. Standard cable length is 3.3 meters. Consult factory for other lengths.  
 \*\* Standard coupling nut material is nickel plated brass .. "RKC(WKC).."; "RKC(WKCV)" indicates stainless steel.

We reserve the right to make technical alterations without prior notice.

Cordsets

## Spiral Cordsets, "C" Style Medium Plug Body

- NEMA 1, 3, 4, 6P
- IEC IP68 Protection
- 60 VAC/75 VDC, 2 A



| Connector Style           | Male Part Number   | Features   | Pinout   |
|---------------------------|--|--|--|
| <p><b>RSC ..-SP**</b></p> | <p><b>RSC 6T-3.3/S90-SP</b><br/><b>WSC 6T-3.3/S90-SP</b></p>                     | <p>AWM TPU Black, 6x24 AWG, 90 °C,<br/>5.1 mm OD, for repetitive motion<br/>6-wire DC applications</p> | <p>1. BN<br/>2. WH<br/>3. BU<br/>4. BK<br/>5. GY<br/>6. PK</p>                       |
| <p><b>WSC ..-SP**</b></p> | <p><b>RSC 8.6T-3.3/S90-SP/CS10451</b><br/><b>WSC 8.6T-3.3/S90-SP/CS10451</b></p> | <p>AWM TPU Black, 6x24 AWG, 90 °C,<br/>5.1 mm OD, for repetitive motion<br/>6-wire DC applications</p> | <p>1. WH<br/>2. BK<br/>3. PK<br/>4. GY<br/>5. BN<br/>6. N/C<br/>7. BU<br/>8. N/C</p> |

\* Length in meters. Standard cable length is 3.3 meters. Consult factory for other lengths.

\*\* Standard coupling nut material is nickel plated brass .. "RSC(WSC).."; "RSCV(WSCV)" indicates stainless steel.

We reserve the right to make technical alterations without prior notice.

## 8-Pin Cordsets

- NEMA 1, 3, 4, 6P
- IEC IP68 Protection
- 60 VAC/75 VDC, 2 A
- For use with Kübler by Turck's Incremental Encoders



| Connector Style       | Female Part Number   | Male Part Number   | Features  | Pinout  |
|-----------------------|--|--|---|---|
| <p><b>E-RKC..</b></p> | <b>E-RKC 8T-930-*</b><br><b>E-WKC 8T-930-*</b>             | <b>E-RSC 8T-930-*</b><br><b>E-WSC 8T-930-*</b>             | AWM PVC Black, 8x24 AWG, 105 °C, 7.2 mm OD, Cable #RF50930-*,M, Differential Mode Applications, RFI/EMI Protection        | 1. WH<br>2. BN<br>3. GN<br>4. YE<br>5. GY<br>6. PK<br>7. BU<br>8. RD    |
| <p><b>E-WKC..</b></p> | <b>E-RKC 8T-930-*/S1115</b><br><b>E-WKC 8T-930-*/S1115</b> | <b>E-RSC 8T-930-*/S1115</b><br><b>E-WSC 8T-930-*/S1115</b> | AWM PVC Black, 8x24 AWG, 105 °C, 7.2 mm OD, Cable #RF50930-*,M, Single Ended Mode Applications, RFI/EMI Protection        | 1. WH<br>2. BN<br>3. GN<br>4. N/C<br>5. GY<br>6. N/C<br>7. BU<br>8. N/C |
| <p><b>E-RSC..</b></p> |  |  |   |   |
| <p><b>E-WSC..</b></p> | <b>E-RKC 8T-264-*</b><br><b>E-WKC 8T-264-*</b>             | <b>E-RSC 8T-264-*</b><br><b>E-WSC 8T-264-*</b>             | AWM PVC Black, 8x24 AWG, 4 STP, 105 °C, 6.6 mm OD, Cable #RF51264-*,M, Differential Mode Applications, RFI/EMI Protection | 1. WH<br>2. BN<br>3. GN<br>4. YE<br>5. GY<br>6. PK<br>7. BU<br>8. RD    |

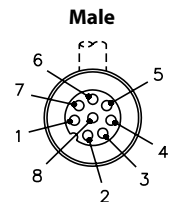
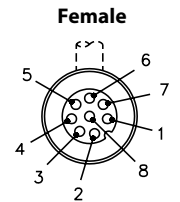

We reserve the right to make technical alterations without prior notice.

\* Length in meters. Standard cable lengths are 2, 5, 10 and 15 meters. Consult factory for other lengths.  
 \*\* Standard coupling nut material is nickel plated brass "E-RKC../E-WKC../E-RKS../E-WKS.."; "E-RKCV../E-WKCV../E-RKSV../E-WKSV.." indicates stainless steel.  
 STP = Shielded twisted pair.

Cordsets

## 8-Pin Cordsets

- IEC IP67
- 60 VAC/75 VDC, 2 A
- For use with Kübler by Turck's Incremental Encoders



| Connector Style       | Female Part Number                                     | Male Part Number                                       | Features  | Pinout               |
|-----------------------|--|--|---|----------------------|
| <p><b>E-RKC..</b></p> | <p><b>E-RKS 8T-930-*</b><br/><b>E-WKS 8T-930-*</b></p> | <p><b>E-RSS 8T-930-*</b><br/><b>E-WSS 8T-930-*</b></p> | <p>AWM PVC Black 8x24<br/>AWG 105 °C 7.2 mm OD<br/>Cable #RF50930-*M,<br/>Differential Mode<br/>Applications, Shield Tied<br/>to Coupling Nut, RFI/EMI<br/>Protection</p> | <p><b>Female</b></p> |
| <p><b>E-WKS..</b></p> |  |  |   |                      |
| <p><b>E-RSS..</b></p> |  |  |   |                      |
| <p><b>E-WSS..</b></p> |  |  |   |                      |
|                       | <p><b>E-RKS 8T-264-*</b><br/><b>E-WKS 8T-264-*</b></p> | <p><b>E-RSS 8T-264-*</b><br/><b>E-WSS 8T-264-*</b></p> | <p>AWM PVC Black,<br/>8x24 AWG, 4 STP,<br/>105 °C, 6.6 mm OD,<br/>Cable #RF51264-*M,<br/>Differential Mode<br/>Applications, RFI/EMI<br/>Protection</p>                   | <p><b>Male</b></p>   |

1. WH
2. BN
3. GN
4. YE
5. GY
6. PK
7. BU
8. RD

We reserve the right to make technical alterations without prior notice.

\* Length in meters. Standard cable lengths are 2, 5, 10 and 15 meters. Consult factory for other lengths.

\*\* Standard coupling nut material is nickel plated brass "E-RKC../E-WKC../E-RKS../E-WKS.."; "E-RKCV../E-WKCV../E-RKSV../E-WKSV.." indicates stainless steel.  
STP = Shielded twisted pair.



## 3, 4, 5 and 6-Wire Washdown Cordsets

- NEMA 1, 3, 4, 6P
- IEC IP68 Protection
- Polypropylene Contact Holder, Mold Material & Cable Jacket
- High Chemical Solvent Resistance, High Tensile Strength



| Connector Style         | Female Part Number                             | Male Part Number                               | Features   | Pinout            |
|-------------------------|--|--|--|-------------------|
| <p><b>WD-RKCV..</b></p> | <b>WD-RKCV 4T-*</b><br><b>WD-WKCV 4T-*</b>     | <b>WD-RSCV 4T-*</b><br><b>WD-WSCV 4T-*</b>     | PP White, 3x20 AWG<br>105 °C, 250 V, 4 A<br>5.1 mm OD,<br>Cable #RF51440-*M        | <b>Female</b><br> |
|                         | <b>WD-RKCV 4.4T-*</b><br><b>WD-WKCV 4.4T-*</b> | <b>WD-RSCV 4.4T-*</b><br><b>WD-WSCV 4.4T-*</b> | PP White, 4x22 AWG<br>105 °C, 250 V, 4 A<br>4.4 mm OD,<br>Cable #RF51359-*M        | <b>Male</b><br>   |
| <p><b>WD-WKCV..</b></p> | <b>WD-RKCV 4.5T-*</b><br><b>WD-WKCV 4.5T-*</b> | <b>WD-RSCV 4.5T-*</b><br><b>WD-WSCV 4.5T-*</b> | PP White, 5x22 AWG<br>105 °C, 250 V, 4 A<br>4.5 mm OD<br>Cable #RF51466-*M         | <b>Female</b><br> |
|                         | <b>WD-RKCV 4.5T-*</b><br><b>WD-WKCV 4.5T-*</b> | <b>WD-RSCV 4.5T-*</b><br><b>WD-WSCV 4.5T-*</b> | PP White, 5x22 AWG<br>105 °C, 250 V, 4 A<br>4.5 mm OD<br>Cable #RF51466-*M         | <b>Male</b><br>   |
| <p><b>WD-RSCV..</b></p> | <b>WD-RKCV 6T-*</b><br><b>WD-WKCV 6T-*</b>     | <b>WD-RSCV 6T-*</b><br><b>WD-WSCV 6T-*</b>     | PP White, 6x24 AWG<br>105 °C, 60 VAC/75 VDC,<br>2 A 4.5 mm OD<br>Cable #RF51467-*M | <b>Female</b><br> |
| <p><b>WD-WSCV..</b></p> | <b>WD-RKCV 6T-*</b><br><b>WD-WKCV 6T-*</b>     | <b>WD-RSCV 6T-*</b><br><b>WD-WSCV 6T-*</b>     | PP White, 6x24 AWG<br>105 °C, 60 VAC/75 VDC,<br>2 A 4.5 mm OD<br>Cable #RF51467-*M | <b>Male</b><br>   |

We reserve the right to make technical alterations without prior notice.

Cordsets

\* Length in meters. Standard cable lengths are 2, 5, 10 and 15 meters. Consult factory for other lengths. Standard coupling nut material is stainless steel.

## 8, 10 and 12-Wire Washdown Cordsets

- NEMA 1, 3, 4, 6P
- IEC IP68 Protection
- Polypropylene Contact Holder, Mold Material & Cable Jacket
- High Chemical Solvent Resistance, High Tensile Strength



| Connector Style         | Female Part Number                                   | Male Part Number                                     | Features   | Pinout  |
|-------------------------|--|--|--|---|
| <p><b>WD-RKCV..</b></p> | <p><b>WD-RKCV 8T-*</b><br/><b>WD-WKCV 8T-*</b></p>   | <p><b>WD-RSCV 8T-*</b><br/><b>WD-WSCV 8T-*</b></p>   | <p>PP White, 8x24 AWG,<br/>105 °C, 60 VAC/75 VDC,<br/>2 A, 5.1 mm OD,<br/>Cable #RF51465-*M</p>  | <p><b>Female</b></p> <p>1. WH<br/>2. BN<br/>3. GN<br/>4. YE<br/>5. GY<br/>6. PK<br/>7. BU<br/>8. RD</p> <p><b>Male</b></p>  |
| <p><b>WD-WKCV..</b></p> | <p><b>WD-RKCV 10T-*</b><br/><b>WD-WKCV 10T-*</b></p> | <p><b>WD-RSCV 10T-*</b><br/><b>WD-WSCV 10T-*</b></p> | <p>PP White, 10x24 AWG,<br/>105 °C, 60 VAC/75 VDC,<br/>2 A, 5.7 mm OD,<br/>Cable #RF51602-*M</p> | <p><b>Female</b></p> <p>1. WH<br/>2. BN<br/>3. GN<br/>4. YE<br/>5. GY<br/>6. PK<br/>7. BU<br/>8. RD<br/>9. OG<br/>10. TN</p> <p><b>Male</b></p>                       |
| <p><b>WD-RSCV..</b></p> |  |  |  |   |
| <p><b>WD-WSCV..</b></p> | <p><b>WD-RKCV 12T-*</b><br/><b>WD-WKCV 12T-*</b></p> | <p><b>WD-RSCV 12T-*</b><br/><b>WD-WSCV 12T-*</b></p> | <p>PP White, 12x24 AWG,<br/>105 °C, 60 VAC/75 VDC,<br/>2 A, 5.7 mm OD,<br/>Cable #RF51464-*M</p> | <p><b>Female</b></p> <p>1. WH<br/>2. BN<br/>3. GN<br/>4. YE<br/>5. GY<br/>6. PK<br/>7. BU<br/>8. RD<br/>9. OG<br/>10. TN<br/>11. BK<br/>12. VT</p> <p><b>Male</b></p> |

We reserve the right to make technical alterations without prior notice.

\* Length in meters. Standard cable lengths are 2, 4, 5, 6, 8 and 10 meters. Consult factory for other lengths. Standard coupling nut material is stainless steel.

## 3, 4 and 5-Wire True Torque Cordsets

- Integrated Torque Control System
- IEC IP67
- 250 V, 4 A (3 & 4-wires) 60 V, 4 A (5-wire)



| Connector Style     | Female Part Number   | Male Part Number   | Features                             | Pinout  |
|---------------------|--|--|--------------------------------------|---|
| <b>NM-RKC..</b><br> | <b>NM-RKC 4T-*/S849</b><br><b>NM-WKC 4T-*/S849</b>             | <b>NM-RSC 4T-*/S849</b><br><b>NM-WSC 4T-*/S849</b>             | PVC Grey, 3x22 AWG, 80 °C, 5.2 mm OD | 1. BN<br>2. N/C<br>3. BU<br>4. BK<br>         |
|                     | <b>NM-RKC 4T-*/S90/S849</b><br><b>NM-WKC 4T-*/S90/S849</b>     | <b>NM-RSC 4T-*/S90/S849</b><br><b>NM-WSC 4T-*/S90/S849</b>     | TPU Grey, 3x22 AWG, 80 °C, 5.2 mm OD | 1. BN<br>2. N/C<br>3. BU<br>4. BK<br>         |
| <b>NM-WKC..</b><br> | <b>NM-RKC 4.4T-*/S849</b><br><b>NM-WKC 4.4T-*/S849</b>         | <b>NM-RSC 4.4T-*/S849</b><br><b>NM-WSC 4.4T-*/S849</b>         | PVC Grey, 4x22 AWG, 80 °C, 5.2 mm OD | 1. BN<br>2. WH<br>3. BU<br>4. BK<br>          |
|                     | <b>NM-RKC 4.4T-*/S90/S849</b><br><b>NM-WKC 4.4T-*/S90/S849</b> | <b>NM-RSC 4.4T-*/S90/S849</b><br><b>NM-WSC 4.4T-*/S90/S849</b> | TPU Grey, 4x22 AWG, 80 °C, 5.2 mm OD | 1. BN<br>2. WH<br>3. BU<br>4. BK<br>          |
| <b>NM-RSC..</b><br> | <b>NM-RKC 4.5T-*/S849</b><br><b>NM-WKC 4.5T-*/S849</b>         | <b>NM-RSC 4.5T-*/S849</b><br><b>NM-WSC 4.5T-*/S849</b>         | PVC Grey, 5x22 AWG, 80 °C, 5.2 mm OD | 1. BN<br>2. WH<br>3. BU<br>4. BK<br>5. GY<br> |
|                     | <b>NM-RKC 4.5T-*/S90/S849</b><br><b>NM-WKC 4.5T-*/S90/S849</b> | <b>NM-RSC 4.5T-*/S90/S849</b><br><b>NM-WSC 4.5T-*/S90/S849</b> | TPU Grey, 5x22 AWG, 80 °C, 5.2 mm OD | 1. BN<br>2. WH<br>3. BU<br>4. BK<br>5. GY<br> |

We reserve the right to make technical alterations without prior notice.

Cordsets

\* Length in meters. Standard cable lengths are 2, 5, and 10 meters. Consult factory for other lengths. Standard coupling nut material is nickel-plated brass/nylon combination.

## 4 and 5-Wire S12 Quick-Connect™ Cordsets

- Straight and Right Angle Female Connectors
- IEC IP 67 Protection
- 250 V, 4 A
- Nylon Coupling Nut



| Connector Style                         | Female Part Number                                       | Male Part Number   | Features  | Pinout                                  |
|---|--|--|---|---|
| <p><b>RKC..</b></p> <p><b>WKC..</b></p> | <p><b>RKC 4.4Q-*/S849</b><br/><b>WKC 4.4Q-*/S849</b></p> | <p><b>RSC 4.4Q-*/S849</b><br/><b>WSC 4.4Q-*/S849</b></p> | <p>ITC/PLTC PVC Grey, 4x22 AWG, 105 °C, 5.3 mm OD, Cable #RF50516-*/M, Quick-Connect coupling</p> | <p><b>Female</b></p> <p><b>Male</b></p> |
| <p><b>RSC..</b></p> <p><b>WSC..</b></p> | <p><b>RKC 4.5Q-*/S849</b><br/><b>WKC 4.5Q-*/S849</b></p> | <p><b>RSC 4.5Q-*/S849</b><br/><b>WSC 4.5Q-*/S849</b></p> | <p>ITC/PLTC PVC Grey, 5x22 AWG, 105 °C, 5.7 mm OD, Cable #RF50543-*/M, Quick-Connect coupling</p> | <p><b>Female</b></p> <p><b>Male</b></p> |

We reserve the right to make technical alterations without prior notice.

\* Length in meters. Standard cable lengths are 2, 4, 6, 8 and 10 meters. Consult factory for other lengths.

Receptacle Selection Guide

We reserve the right to make technical alterations without prior notice.

| Mounting Style   | Image | Panel Thread Types       | Page |
|------------------|-------|--------------------------|------|
| Front Mount      |       | PG 9                     | D46  |
|                  |       | 1/4-18 NPT               | D49  |
|                  |       | 1/2-14 NPSM              | D52  |
|                  |       | 1/2-14 NPT               | D54  |
|                  |       | M20                      | D57  |
|                  |       | PG 16                    | D59  |
|                  |       | PG 13.5                  | D60  |
|                  |       | PG 9 w/Rotating Coupling | D61  |
|                  |       | 1/4-18 w/Solder Cups     | D62  |
|                  |       | PG 9 w/Solder Cups       | D63  |
| PG 9 Reverse Key | D77   |                          |      |
| Rear Mount       |       | PG 9 w/Leads             | D66  |
|                  |       | PG 9 w/Solder Cups       | D68  |
|                  |       | PG 9 Reverse Key         | D79  |
|                  |       | Back Panel Mount         | D81  |
| PCB Mount        |       | PG 9 w/PCB Pins          | D70  |
|                  |       | PG 9 PCB w/Header Pins   | D73  |
|                  |       | Circuit Board Mounted    | D75  |

## 2, 4 and 5-Wire Receptacles, Front Mount, PG 9 Threads

- NEMA 1, 3, 4, 6P
- IEC IP68 Protection
- 250 V, 4 A



| Housing Style  | Female Part Number   | Male Part Number     | Features   | Pinout   |
|--|----------------------|----------------------|--|--|
| <p><b>FK(N) ..*</b></p> <p>Typical panel cutout is 15.2 mm</p> | <b>FK 4.2-*</b>      | <b>FS 4.2-*</b>      | 2x22 AWG, 105 °C, mates with 2-pin cordsets  | 1. N/C<br>2. N/C<br>3. BN<br>4. BU<br>           |
|  | <b>FK 4.21-*</b>     | <b>FS 4.21-*</b>     | 2x22 AWG, 105 °C, mates with 2-pin cordsets  | 1. BN<br>2. BU<br>3. N/C<br>4. N/C<br>           |
|  | <b>FK 4.22-*</b>     | <b>FS 4.22-*</b>     | 2x22 AWG, 105 °C, mates with 2-pin cordsets  | 1. BN<br>2. N/C<br>3. BU<br>4. N/C<br>           |
|  | <b>FK 4.4-*</b>      | <b>FS 4.4-*</b>      | 4x22 AWG, 105 °C, mates with 4-pin cordsets  | 1. BN<br>2. WH<br>3. BU<br>4. BK<br>             |
|  | <b>FK 4.4-*/S613</b> | <b>FS 4.4-*/S613</b> | 4x18 AWG, 105 °C, mates with 4-pin cordsets  | 1. BN<br>2. WH<br>3. BU<br>4. BK<br>             |
|  | <b>FK 4.4-*/S621</b> | <b>FS 4.4-*/S621</b> | 4x18 AWG, 105 °C, mates with 4-pin cordsets  | 1. GY1<br>2. GY2<br>3. GY3<br>4. GY4<br>         |
|  | <b>FK 4.5-*</b>      | <b>FS 4.5-*</b>      | 5x22 AWG, 105 °C, mates with 5-pin cordsets  | 1. BN<br>2. WH<br>3. BU<br>4. BK<br>5. GY<br>    |
| <p><b>FS(N) ..*</b></p> <p>Typical panel cutout is 15.2 mm</p> | <b>FK 4.5-*/S627</b> | <b>FS 4.5-*/S627</b> | 5x20 AWG, 105 °C, mates with 5-pin cordsets  |  |
|  | <b>FK 4.5-*/S653</b> | <b>FS 4.5-*/S653</b> | 4x22 AWG, Drain, 105 °C, 5.1 mm OD, mates with 5-pin cordsets, 4 conductors PVC foil shielded with drain wire to pin 5 | 1. BN<br>2. WH<br>3. BU<br>4. BK<br>5. Drain<br> |
|  | <b>FKN 5-*</b>       | <b>FSN 5-*</b>       | 5x22 AWG, 105 °C   | 1. GN<br>2. WH<br>3. OG<br>4. BK<br>5. RD<br>    |

We reserve the right to make technical alterations without prior notice.

\* Length in meters. Standard Lead length is 0.5 meters. Consult factory for other lengths. Standard housing material is nickel plated brass "FS.."; "FSV.." indicates stainless steel. To specify PVC jacketed cable, add "/S717" to the end of the part number.

## 6 and 8-Wire Receptacles, Front Mount, PG 9 Threads

- NEMA 1, 3, 4, 6P
- IEC IP68 Protection



We reserve the right to make technical alterations without prior notice.

| Connector Style   | Female Part Number | Male Part Number | Features   | Pinout                                  |
|---|--------------------|------------------|--|---|
| <p><b>FK ..*</b></p> <p>Typical panel cutout is 15.2 mm</p> | <b>FK 4.6-*</b>    | <b>FS 4.6-*</b>  | 6x22 AWG, 105 °C, 250 V, 4 A mates with 6-pin cordsets         | <p><b>Female</b></p> <p><b>Male</b></p> |
|   | <b>FK 6-*</b>      | <b>FS 6-*</b>    | 6x24 AWG, 105 °C, 60 VAC/75 VDC, 2 A mates with 6-pin cordsets | <p><b>Female</b></p> <p><b>Male</b></p> |
| <p><b>FS ..*</b></p> <p>Typical panel cutout is 15.2 mm</p> | <b>FK 8-*</b>      | <b>FS 8-*</b>    | 8x24 AWG, 105 °C, 60 VAC/75 VDC, 2 A mates with 8-pin cordsets | <p><b>Female</b></p>                    |
|   | <b>FK 8.6-*</b>    | <b>FS 8.6-*</b>  | 6x24 AWG, 105 °C, 60 VAC/75 VDC, 2 A mates with 8-pin cordsets | <p><b>Male</b></p>                      |

\* Length in meters. Standard lead length is 0.5 meters. Consult factory for other lengths. Standard housing material is nickel plated brass "FS.."; "FSV.." indicates stainless steel. To specify PVC jacketed cable, add "/S717" to the end of the part number.

Receptacles

## 10 and 12-Wire Receptacles, Front Mount, PG 9 Threads

- NEMA 1, 3, 4, 6P
- IEC IP68 Protection
- 60 VAC/75 VDC, 2 A



| Connector Style  | Female Part Number | Male Part Number | Features                                      | Pinout                                  |
|--|--------------------|------------------|---|---|
| <p><b>FK 10-*</b></p> <p>Typical panel cutout is 15.2 mm</p> | <b>FK 10-*</b>     | <b>FS 10-*</b>   | 10x24 AWG, 105 °C, mates with 10-pin cordsets | <p><b>Female</b></p> <p><b>Male</b></p> |
| <p><b>FK 12-*</b></p> <p>Typical panel cutout is 15.2 mm</p> | <b>FK 12-*</b>     | <b>FS 12-*</b>   | 12x24 AWG, 105 °C, mates with 12-pin cordsets | <p><b>Female</b></p> <p><b>Male</b></p> |

We reserve the right to make technical alterations without prior notice.

\* Length in meters. Standard lead length is 0.5 meters. Consult factory for other lengths. Standard housing material is nickel plated brass "FS.."; "FSV.." indicates stainless steel. To specify PVC jacketed cable, add "/S717" to the end of the part number.



## 4 and 5-Wire Receptacles, Front Mount, 1/4-18 NPT Threads

- NEMA 1, 3, 4, 6P
- IEC IP68 Protection
- 250 V, 4 A



| Housing Style  | Female Part Number         | Male Part Number           | Features   | Pinout   |
|--|----------------------------|----------------------------|--|--|
| <p><b>FK..*/18.25</b></p> <p>Typical panel cutout is 14.3 mm</p> | <b>FK 4.4-*/18.25</b>      | <b>FS 4.4-*/18.25</b>      | 4x22 AWG, 105 °C, mates with 4-pin cordsets  | <p><b>Female</b></p> <p><b>Male</b></p>        |
|  | <b>FK 4.4-*/18.25/S613</b> | <b>FS 4.4-*/18.25/S613</b> | 4x18 AWG, 105 °C, mates with 4-pin cordsets  | 1. BN<br>2. WH<br>3. BU<br>4. BK               |
|  | <b>FK 4.4-*/18.25/S621</b> | <b>FS 4.4-*/18.25/S621</b> | 4x18 AWG, 105 °C, mates with 4-pin cordsets  | 1. GY1<br>2. GY2<br>3. GY3<br>4. GY4           |
|  | <b>FK 4.5-*/18.25</b>      | <b>FS 4.5-*/18.25</b>      | 5x22 AWG, 105 °C, mates with 5-pin Cordsets  | 1. BN<br>2. WH<br>3. BU<br>4. BK<br>5. GY      |
|  | <b>FK 4.5-*/18.25/S627</b> | <b>FS 4.5-*/18.25/S627</b> | 5x20 AWG, 105 °C, mates with 5-pin cordsets  |  |
|  | <b>FK 4.5-*/18.25/S653</b> | <b>FS 4.5-*/18.25/S653</b> | 4x22 AWG, Drain, 105 °C, 5.1 mm OD, mates with 5-pin cordsets, 4 conductors PVC foil shielded with drain wire to pin 5 | 1. BN<br>2. WH<br>3. BU<br>4. BK<br>5. Drain   |
| <p><b>FS..18.25</b></p> <p>Typical panel cutout is 14.3 mm</p>   | <b>FK 4.5-*/18.25/S621</b> | <b>FS 4.5-*/18.25/S621</b> | 5x18 AWG, 105 °C, mates with 5-pin cordsets  | 1. GY1<br>2. GY2<br>3. GY3<br>4. GY4<br>5. GY5 |

We reserve the right to make technical alterations without prior notice.

Receptacles

\* Length in meters. Standard lead length is 0.5 meters. Consult factory for other lengths. Standard housing material is nickel plated brass "FS.."; "FSV.." indicates stainless steel. To specify PVC jacketed cable, add "/S717" to the end of the part number.

## 6 and 8-Wire Receptacles, Front Mount, 1/4-18 NPT Threads

- NEMA 1, 3, 4, 6P
- IEC IP68 Protection



| Housing Style  | Female Part Number        | Male Part Number          | Features  | Pinout                                  |
|--|---------------------------|---------------------------|---|---|
| <p><b>FK..*/18.25</b></p> <p>Typical panel cutout is 14.3 mm</p> | <b>FK 4.6-*/18.25</b>     | <b>FS 4.6-*/18.25</b>     | 6x22 AWG, 105 °C, 250 V, 2 A, mates with 6-pin cordsets         | <p><b>Female</b></p> <p><b>Male</b></p> |
|  | <b>FK 6-*/18.25</b>       | <b>FS 6-*/18.25</b>       | 6x24 AWG, 105 °C, 60 VAC/75 VDC, 2 A, mates with 6-pin cordsets | <p><b>Female</b></p> <p><b>Male</b></p> |
|  | <b>FK 8-*/18.25</b>       | <b>FS 8-*/18.25</b>       | 8x24 AWG, 105 °C, 60 VAC/75 VDC, 2 A, mates with 8-pin cordsets | <p><b>Female</b></p>                    |
|  | <b>FK 8-*/18.25/S1505</b> | <b>FS 8-*/18.25/S1505</b> | 8x26 AWG, 105 °C, 60 VAC/75 VDC, 2 A, mates with 8-pin cordsets | <p><b>Female</b></p>                    |
|  | <b>FK 8.6-*/18.25</b>     | <b>FS 8.6-*/18.25</b>     | 6x24 AWG, 105 °C, 60 VAC/75 VDC, 2 A, mates with 8-pin cordsets | <p><b>Male</b></p>                      |

We reserve the right to make technical alterations without prior notice.

\* Length in meters. Standard lead length is 0.5 meters. Consult factory for other lengths. Standard housing material is nickel plated brass "FS.."; "FSV.." indicates stainless steel. To specify PVC jacketed cable, add "/S717" to the end of the part number.

## 10 and 12-Wire Receptacles, Front Mount, 1/4-18 NPT Threads

- NEMA 1, 3, 4, 6P
- IEC IP68 Protection
- 60 VAC/75 VDC, 2 A



| Housing Style   | Female Part Number   | Male Part Number     | Features                                      | Pinout                                  |
|---|----------------------|----------------------|---|---|
| <p><b>FK ..*/18.25</b></p> <p>Typical panel cutout is 14.3 mm</p> | <b>FK 10-*/18.25</b> | <b>FS 10-*/18.25</b> | 10x24 AWG, 105 °C, mates with 10-pin cordsets | <p><b>Female</b></p> <p><b>Male</b></p> |
| <p><b>FS ..18.25</b></p> <p>Typical panel cutout is 14.3 mm</p>   | <b>FK 12-*/18.25</b> | <b>FS 12-*/18.25</b> | 12x24 AWG, 105 °C, mates with 12-pin cordsets | <p><b>Female</b></p> <p><b>Male</b></p> |

We reserve the right to make technical alterations without prior notice.

Receptacles

\* Length in meters. Standard lead length is 0.5 meters. Consult factory for other lengths. Standard housing material is nickel plated brass "FS.."; "FSV.." indicates stainless steel. To specify PVC jacketed cable, add "/S717" to the end of the part number.

## 4, 5, and 6-Wire Receptacles, Front Mount, 1/2-14 NPSM Threads

- NEMA 1, 3, 4, 6P
- IEC IP68 Protection



| Housing Style   | Female Part Number        | Male Part Number          | Features   | Pinout   |
|---|---------------------------|---------------------------|--|--|
| <p><b>FK ..14.5</b></p> <p>Typical panel cutout is 21 mm</p>  | <b>FK 4.4-*/14.5</b>      | <b>FS 4.4-*/14.5</b>      | 4x22 AWG,<br>105 °C, 250 V,<br>4 A, mates<br>with 4-pin<br>cordsets            | 1. BN<br>2. WH<br>3. BU<br>4. BK                   |
|   | <b>FK 4.4-*/14.5/S613</b> | <b>FS 4.4-*/14.5/S613</b> | 4x18 AWG,<br>105 °C, 250 V,<br>4 A, mates<br>with 4-pin<br>cordsets            | 1. BN<br>2. WH<br>3. BU<br>4. BK                   |
|   | <b>FK 4.4-*/14.5/S621</b> | <b>FS 4.4-*/14.5/S621</b> | 4x18 AWG,<br>105 °C, 250 V,<br>4 A, mates<br>with 4-pin<br>cordsets            | 1. GY1<br>2. GY2<br>3. GY3<br>4. GY4               |
| <p><b>FS .. 14.5</b></p> <p>Typical panel cutout is 21 mm</p> | <b>FK 4.5-*/14.5</b>      | <b>FS 4.5-*/14.5</b>      | 5x22 AWG,<br>105 °C, 250 V,<br>4 A, mates<br>with 5-pin<br>cordsets            | 1. BN<br>2. WH<br>3. BU<br>4. BK<br>5. GY          |
|   | <b>FK 4.6-*/14.5</b>      | <b>FS 4.6-*/14.5</b>      | 6x22 AWG,<br>105 °C, 250 V,<br>4 A, mates<br>with 6-pin<br>cordsets            | 1. BN<br>2. WH<br>3. BU<br>4. BK<br>5. GY<br>6. PK |
|   | <b>FK 6-*/14.5</b>        | <b>FS 6-*/14.5</b>        | 6x24 AWG,<br>105 °C, 60<br>VAC/75 VDC,<br>2 A, mates<br>with 6-pin<br>cordsets | 1. BN<br>2. WH<br>3. BU<br>4. BK<br>5. GY<br>6. PK |

We reserve the right to make technical alterations without prior notice.

\* Length in meters. Standard cable length is 0.5 meters. Consult factory for other lengths. Standard housing material is nickel plated brass "FS.."; "FSV.." indicates stainless steel. To specify PVC jacketed cable, add "/S717" to the end of the part number.

## 8, 10 and 12-Wire Receptacles, Front Mount, 1/2-14 NPSM Threads

- NEMA 1, 3, 4, 6P
- IEC IP68 Protection
- 60 VAC/75 VDC, 2 A



We reserve the right to make technical alterations without prior notice.

| Housing Style  | Female Part Number   | Male Part Number     | Features  | Pinout  |
|--|----------------------|----------------------|---|---|
| <p><b>FK ..14.5</b></p> <p>Typical panel cutout is 21 mm</p> | <b>FK 8-*/14.5</b>   | <b>FS 8-*/14.5</b>   | 8x24 AWG, 105 °C, mates with 8-pin cordsets, CSA Approved | <p>1. WH<br/>2. BN<br/>3. GN<br/>4. YE<br/>5. GY<br/>6. PK<br/>7. BU<br/>8. RD</p> <p><b>Female</b></p> <p><b>Male</b></p>  |
|  | <b>FK 8.6-*/14.5</b> | <b>FS 8.6-*/14.5</b> | 6x24 AWG, 105 °C, mates with 8-pin cordsets, CSA Approved | <p>1. WH<br/>2. GN<br/>3. YE<br/>4. GY<br/>5. BN<br/>6. N/C<br/>7. BU<br/>8. N/C</p> <p><b>Female</b></p> <p><b>Male</b></p>  |
|  | <b>FK 10-*/14.5</b>  | <b>FS 10-*/14.5</b>  | 10x24 AWG, 105 °C, mates with 10-pin cordsets             | <p>1. WH<br/>2. BN<br/>3. GN<br/>4. YE<br/>5. GY<br/>6. PK<br/>7. BU<br/>8. RD<br/>9. OG<br/>10. TN</p> <p><b>Female</b></p> <p><b>Male</b></p>                       |
|  | <b>FK 12-*/14.5</b>  | <b>FS 12-*/14.5</b>  | 12x24 AWG, 105 °C, mates with 12-pin cordsets             | <p>1. WH<br/>2. BN<br/>3. GN<br/>4. YE<br/>5. GY<br/>6. PK<br/>7. BU<br/>8. RD<br/>9. OG<br/>10. TN<br/>11. BK<br/>12. VT</p> <p><b>Female</b></p> <p><b>Male</b></p> |

\* Length in meters. Standard lead length is 0.5 meters. Consult factory for other lengths. Standard housing material is nickel plated brass "FS.."; "FSV.." indicates stainless steel. To specify PVC jacketed cable, add "/S717" to the end of the part number.

Receptacles

## 2 and 4-Wire Receptacles, Front Mount, 1/2-14 NPT Threads

- NEMA 1, 3, 4, 6P
- IEC IP68 Protection
- 250 V, 4 A



| Housing Style   | Female Part Number            | Male Part Number              | Features                                    | Pinout                                       |
|---|-------------------------------|-------------------------------|---|--|
| <p><b>FK .. 14.5/NPT</b></p> <p>Typical panel cutout is 22.5 mm</p> | <b>FK 4.2-*/14.5/NPT</b>      | <b>FS 4.2-*/14.5/NPT</b>      | 2x22 AWG, 105 °C, mates with 2-pin cordsets | <p><b>Female</b></p>                         |
|   | <b>FK 4.22-*/14.5/NPT</b>     | <b>FS 4.22-*/14.5/NPT</b>     | 2x22 AWG, 105 °C, mates with 2-pin cordsets | <p>1. BN<br/>2. N/C<br/>3. BU<br/>4. N/C</p> |
| <p><b>FS .. 14.5/NPT</b></p> <p>Typical panel cutout is 22.5 mm</p> | <b>FK 4.4-*/14.5/NPT</b>      | <b>FS 4.4-*/14.5/NPT</b>      | 4x22 AWG, 105 °C, mates with 4-pin cordsets | <p><b>Male</b></p>                           |
|   | <b>FK 4.4-*/14.5/NPT/S613</b> | <b>FS 4.4-*/14.5/NPT/S613</b> | 4x18 AWG, 105 °C, mates with 4-pin cordsets | <p>1. BN<br/>2. WH<br/>3. BU<br/>4. BK</p>   |

\* Length in meters. Standard lead length is 0.5 meters. Consult factory for other lengths. Standard housing material is nickel plated brass "FS.."; "FSV.." indicates stainless steel. To specify PVC jacketed cable, add "/S717" to the end of the part number.

We reserve the right to make technical alterations without prior notice.

## 5 and 6-Wire Receptacles, Front Mount, 1/2-14 NPT Threads

- NEMA 1, 3, 4, 6P
- IEC IP68 Protection



| Housing Style  | Female Part Number       | Male Part Number         | Features  | Pinout   |
|--|--------------------------|--------------------------|---|--|
| <p><b>FK ..14.5/NPT</b></p> <p>Typical panel cutout is 22.5 mm</p>   | <b>FK 4.5-*/14.5/NPT</b> | <b>FS 4.5-*/14.5/NPT</b> | 5x22 AWG, 105 °C, 250 V, 4 A, mates with 5-pin cordsets         | <p><b>Female</b></p> <p><b>Male</b></p> <p>1. BN<br/>2. WH<br/>3. BU<br/>4. BK<br/>5. GY</p>           |
| <p><b>FS .. 14.5/NPT</b></p> <p>Typical panel cutout is 22.5 mm</p>  | <b>FK 4.6-*/14.5/NPT</b> | <b>FS 4.6-*/14.5/NPT</b> | 6x22 AWG, 105 °C, 250 V, 4 A, mates with 6-pin cordsets         | <p><b>Female</b></p> <p><b>Male</b></p> <p>1. BN<br/>2. WH<br/>3. BU<br/>4. BK<br/>5. GY<br/>6. PK</p> |
| <p><b>FK 6-*/14.5/NPT</b></p> <p>Typical panel cutout is 22.5 mm</p> | <b>FK 6-*/14.5/NPT</b>   | <b>FS 6-*/14.5/NPT</b>   | 6x24 AWG, 105 °C, 60 VAC/75 VDC, 2 A, mates with 6-pin cordsets | <p><b>Female</b></p> <p><b>Male</b></p>  |

We reserve the right to make technical alterations without prior notice.

Receptacles

\* Length in meters. Standard lead length is 0.5 meters. Consult factory for other lengths. Standard housing material is nickel plated brass "FS.."; "FSV.." indicates stainless steel. To specify PVC jacketed cable, add "/S717" to the end of the part number.

- NEMA 1, 3, 4, 6P
- IEC IP68 Protection
- 60 VAC/75 VDC, 2 A



| Housing Style   | Female Part Number       | Male Part Number         | Features  | Pinout  |
|---|--------------------------|--------------------------|---|---|
| <p><b>FK ..14.5/NPT</b></p> <p>Typical panel cutout is 22.5 mm</p>  | <b>FK 8-*/14.5/NPT</b>   | <b>FS 8-*/14.5/NPT</b>   | 8x24 AWG, 105 °C, mates with 8-pin cordsets, CSA Approved | <p><b>Female</b></p> <ol style="list-style-type: none"> <li>WH</li> <li>BN</li> <li>GN</li> <li>YE</li> <li>GY</li> <li>PK</li> <li>BU</li> <li>RD</li> </ol>   |
|   | <b>FK 8.6-*/14.5/NPT</b> | <b>FS 8.6-*/14.5/NPT</b> | 6x24 AWG, 105 °C, mates with 8-pin cordsets, CSA Approved | <p><b>Male</b></p> <ol style="list-style-type: none"> <li>WH</li> <li>GN</li> <li>YE</li> <li>GY</li> <li>BN</li> <li>N/C</li> <li>BU</li> <li>N/C</li> </ol>   |
| <p><b>FS .. 14.5/NPT</b></p> <p>Typical panel cutout is 22.5 mm</p> | <b>FK 10-*/14.5/NPT</b>  | <b>FS 10-*/14.5/NPT</b>  | 10x24 AWG, 105 °C, mates with 10-pin cordsets             | <p><b>Female</b></p> <ol style="list-style-type: none"> <li>WH</li> <li>BN</li> <li>GN</li> <li>YE</li> <li>GY</li> <li>PK</li> <li>BU</li> <li>RD</li> <li>OG</li> <li>TN</li> </ol> <p><b>Male</b></p> <ol style="list-style-type: none"> <li>WH</li> <li>BN</li> <li>GN</li> <li>YE</li> <li>GY</li> <li>PK</li> <li>BU</li> <li>RD</li> <li>OG</li> <li>TN</li> </ol>   |
|   | <b>FK 12-*/14.5/NPT</b>  | <b>FS 12-*/14.5/NPT</b>  | 12x24 AWG, 105 °C, mates with 12-pin cordsets             | <p><b>Female</b></p> <ol style="list-style-type: none"> <li>WH</li> <li>BN</li> <li>GN</li> <li>YE</li> <li>GY</li> <li>PK</li> <li>BU</li> <li>RD</li> <li>OG</li> <li>TN</li> <li>BK</li> <li>VT</li> </ol> <p><b>Male</b></p> <ol style="list-style-type: none"> <li>WH</li> <li>BN</li> <li>GN</li> <li>YE</li> <li>GY</li> <li>PK</li> <li>BU</li> <li>RD</li> <li>OG</li> <li>TN</li> <li>BK</li> <li>VT</li> </ol> |

We reserve the right to make technical alterations without prior notice.

\* Length in meters. Standard lead length is 0.5 meters. Consult factory for other lengths. Standard housing material is nickel plated brass "FS.."; "FSV.." indicates stainless steel. To specify PVC jacketed cable, add "/S717" to the end of the part number.



## 4, 5 and 6-Wire Receptacles, Front Mount, M20 Threads

- NEMA 1, 3, 4, 6P
- IEC IP68 Protection



| Housing Style  | Female Part Number  | Male Part Number    | Features  | Pinout   |
|--|---------------------|---------------------|---|--|
| <p><b>FK ../M20</b></p> <p>Typical panel cutout is 20.4 mm</p> | <b>FK 4.4-*/M20</b> | <b>FS 4.4-*/M20</b> | 4x22 AWG, 105 °C, 250 V, 4 A, mates with 4-pin cordsets         | <p><b>Female</b></p> <p><b>Male</b></p> <p>1. BN<br/>2. WH<br/>3. BU<br/>4. BK</p>                     |
| <p><b>FK ../M20</b></p> <p>Typical panel cutout is 20.4 mm</p> | <b>FK 4.5-*/M20</b> | <b>FS 4.5-*/M20</b> | 5x22 AWG, 105 °C, 250 V, 4 A, mates with 5-pin cordsets         | <p><b>Female</b></p> <p><b>Male</b></p> <p>1. BN<br/>2. WH<br/>3. BU<br/>4. BK<br/>5. GY</p>           |
| <p><b>FS ../M20</b></p> <p>Typical panel cutout is 20.4 mm</p> | <b>FK 6-*/M20</b>   | <b>FS 6-*/M20</b>   | 6x24 AWG, 105 °C, 60 VAC/75 VDC, 2 A, mates with 6-pin cordsets | <p><b>Female</b></p> <p><b>Male</b></p> <p>1. BN<br/>2. WH<br/>3. BU<br/>4. BK<br/>5. GY<br/>6. PK</p> |

We reserve the right to make technical alterations without prior notice.

Receptacles

\* Length in meters. Standard lead length is 0.5 meters. Consult factory for other lengths. Standard housing material is nickel plated brass "FS.."; "FSV.." indicates stainless steel. To specify PVC jacketed cable, add "/S717" to the end of the part number.

- NEMA 1, 3, 4, 6P
- IEC IP68 Protection
- 60 VAC/75 VDC, 2 A



| Housing Style  | Female Part Number  | Male Part Number    | Features  | Pinout  |
|--|---------------------|---------------------|---|---|
| <p><b>FK .. / M20</b></p> <p>Typical panel cutout is 20.4 mm</p> | <b>FK 8-*/M20</b>   | <b>FS 8-*/M20</b>   | 8x24 AWG, 105 °C, mates with 8-pin cordsets, CSA Approved | <ol style="list-style-type: none"> <li>1. WH</li> <li>2. BN</li> <li>3. GN</li> <li>4. YE</li> <li>5. GY</li> <li>6. PK</li> <li>7. BU</li> <li>8. RD</li> </ol> <p><b>Female</b></p>   |
|  | <b>FK 8.6-*/M20</b> | <b>FS 8.6-*/M20</b> | 6x24 AWG, 105 °C, mates with 8-pin cordsets, CSA Approved | <ol style="list-style-type: none"> <li>1. WH</li> <li>2. GN</li> <li>3. YE</li> <li>4. GY</li> <li>5. BN</li> <li>6. N/C</li> <li>7. BU</li> <li>8. N/C</li> </ol> <p><b>Male</b></p>   |
|  | <b>FK 10-*/M20</b>  | <b>FS 10-*/M20</b>  | 10x24 AWG, 105 °C, mates with 10-pin cordsets             | <ol style="list-style-type: none"> <li>1. WH</li> <li>2. BN</li> <li>3. GN</li> <li>4. YE</li> <li>5. GY</li> <li>6. PK</li> <li>7. BU</li> <li>8. RD</li> <li>9. OG</li> <li>10. TN</li> </ol> <p><b>Female</b></p> <p><b>Male</b></p>                                 |
|  | <b>FK 12-*/M20</b>  | <b>FS 12-*/M20</b>  | 12x24 AWG, 105 °C, mates with 12-pin cordsets             | <ol style="list-style-type: none"> <li>1. WH</li> <li>2. BN</li> <li>3. GN</li> <li>4. YE</li> <li>5. GY</li> <li>6. PK</li> <li>7. BU</li> <li>8. RD</li> <li>9. OG</li> <li>10. TN</li> <li>11. BK</li> <li>12. VT</li> </ol> <p><b>Female</b></p> <p><b>Male</b></p> |

We reserve the right to make technical alterations without prior notice.

\* Length in meters. Standard lead length is 0.5 meters. Consult factory for other lengths. Standard housing material is nickel plated brass "FS.."; "FSV.." indicates stainless steel. To specify PVC jacketed cable, add "/S717" to the end of the part number.

## 4, 5, 6, 8, 10 and 12-Wire Receptacles, Front Mount, PG 16 Threads

- NEMA 1, 3, 4, 6P
- IEC IP68 Protection



| Connector Style | Male Part Number     | Features   | Pinout  |
|-----------------|----------------------|--|---|
|                 | <b>FS 4.4-*/PG16</b> | 4x22 AWG, 105 °C, 250 V, 4 A, mates with 4-pin cordset, CSA Approved         | 1. BN<br>2. WH<br>3. BU<br>4. BK<br>  |
|                 | <b>FS 4.5-*/PG16</b> | 5x22 AWG, 105 °C, 250 V, 4 A, mates with 5-pin cordset, CSA Approved         | 1. BN<br>2. WH<br>3. BU<br>4. BK<br>5. GY<br>   |
|                 | <b>FS 6-*/PG16</b>   | 6x24 AWG, 105 °C, 60 VAC/75 VDC, 2 A, mates with 6-pin cordset, CSA Approved | 1. BN<br>2. WH<br>3. BU<br>4. BK<br>5. GY<br>6. PK<br>  |
|                 | <b>FS 8-*/PG16</b>   | 8x24 AWG, 105 °C, 60 VAC/75 VDC, 2 A, mates with 8-pin cordset, CSA Approved | 1. WH<br>2. BN<br>3. GN<br>4. YE<br>5. GY<br>6. PK<br>7. BU<br>8. RD<br>  |
|                 | <b>FS 8.6-*/PG16</b> | 6x24 AWG, 105 °C, 60 VAC/75 VDC, 2 A, mates with 8-pin cordset, CSA Approved | 1. WH<br>2. GN<br>3. YE<br>4. GY<br>5. BN<br>6. N/C<br>7. BU<br>8. N/C<br>                                      |
|                 | <b>FS 10-*/PG16</b>  | 10x24 AWG, 105 °C, 60 VAC/75 VDC, 2 A, mates with 10-pin cordset             | 1. WH<br>2. BN<br>3. GN<br>4. YE<br>5. GY<br>6. PK<br>7. BU<br>8. RD<br>9. OG<br>10. TN<br>                     |
|                 | <b>FS 12-*/PG16</b>  | 12x24 AWG, 105 °C, 60 VAC/75 VDC, 2 A, mates with 12-pin cordset             | 1. WH<br>2. BN<br>3. GN<br>4. YE<br>5. GY<br>6. PK<br>7. BU<br>8. RD<br>9. OG<br>10. TN<br>11. BK<br>12. VT<br> |

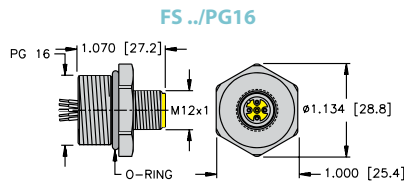

Typical panel cutout is 22.5 mm

We reserve the right to make technical alterations without prior notice.

Receptacles

## 4 and 5-Wire Receptacles, Front Mount, PG 13.5 Threads

- NEMA 1, 3, 4, 6P
- IEC IP68 Protection



| Housing Style  | Male Part Number       | Features   | Pinout  |
|--|------------------------|--|---|
| <p>FS .. / PG13.5</p> <p>Typical panel cutout is 20.4 mm</p> | <b>FS 4.4-*/PG13.5</b> | 4x22 AWG, 105 °C, 250 V, 4 A, mates with 4-pin cordsets, PG 13.5 Threads, CSA Approved         | 1. BN<br>2. WH<br>3. BU<br>4. BK<br>  |
|  | <b>FS 4.5-*/PG13.5</b> | 5x22 AWG, 105 °C, 250 V, 4 A, mates with 5-pin cordsets, PG 13.5 Threads, CSA Approved         | 1. BN<br>2. WH<br>3. BU<br>4. BK<br>5. GY<br>   |
|  | <b>FS 6-*/PG13.5</b>   | 6x22 AWG, 105 °C, 60 VAC/75 VDC, 2 A, mates with 4-pin cordsets, PG 13.5 Threads, CSA Approved | 1. BN<br>2. WH<br>3. BU<br>4. BK<br>5. GY<br>6. PK<br>  |
|  | <b>FS 8-*/PG13.5</b>   | 8x22 AWG, 105 °C, 60 VAC/75 VDC, 2 A, mates with 4-pin cordsets, PG 13.5 Threads, CSA Approved | 1. WH<br>2. BN<br>3. GN<br>4. YE<br>5. GY<br>6. PK<br>7. BU<br>8. RD<br>  |
|  | <b>FS 10-*/PG13.5</b>  | 10x22 AWG, 105 °C, 60 VAC/75 VDC, 2 A, mates with 4-pin cordsets, PG 13.5 Threads              | 1. WH<br>2. BN<br>3. GN<br>4. YE<br>5. GY<br>6. PK<br>7. BU<br>8. RD<br>9. OG<br>10. TN<br>                     |
|  | <b>FS 12-*/PG13.5</b>  | 12x22 AWG, 105 °C, 60 VAC/75 VDC, 2 A, mates with 4-pin cordsets, PG 13.5 Threads              | 1. WH<br>2. BN<br>3. GN<br>4. YE<br>5. GY<br>6. PK<br>7. BU<br>8. RD<br>9. OG<br>10. TN<br>11. BK<br>12. VT<br> |

We reserve the right to make technical alterations without prior notice.

## 4, 5, 6 and 8-Wire Receptacles, with Rotating Coupling Nut

- NEMA 1, 3, 4, 6P
- IEC IP68 Protection



| Housing Style  | Female Part Number    | Features   | Pinout   |
|--|-----------------------|--|--|
| <p><b>FKM ..*</b></p> <p>Typical panel cutout is 15.2 mm</p> | <b>FKM 4.4-*</b>      | 4x22 AWG, 105 °C, 250 V, 4 A, mates with 4-pin cordsets  | 1. BN<br>2. WH<br>3. BU<br>4. BK<br>                                     |
|  | <b>FKM 4.5-*</b>      | 5x22 AWG, 105 °C, 250 V, 4 A, mates with 5-pin cordsets  | 1. BN<br>2. WH<br>3. BU<br>4. BK<br>5. GY<br>                            |
|  | <b>FKM 4.5-*/S653</b> | 4x22 AWG, Drain, 105 °C, 250 V, 4 A, 5.1 mm OD, mates with 5-pin cordsets, 4 conductors PVC foil Shielded with Drain Wire to pin 5 | 1. BN<br>2. WH<br>3. BU<br>4. BK<br>5. Drain<br>                         |
|  | <b>FKM 4.6-*</b>      | 6x22 AWG, 105 °C, 250 V, 2 A, mates with 6-pin cordsets  | 1. BN<br>2. WH<br>3. BU<br>4. BK<br>5. GY<br>6. PK<br>                   |
|  | <b>FKM 6-*</b>        | 6x24 AWG, 105 °C, 60 VAC/75 VDC, 2 A, mates with 6-pin cordsets  | 1. BN<br>2. WH<br>3. BU<br>4. BK<br>5. GY<br>6. PK<br>                   |
|  | <b>FKM 8-*</b>        | 8x24 AWG, 105 °C, 60 VAC/75 VDC, 2 A, mates with 8-pin cordsets  | 1. WH<br>2. BN<br>3. GN<br>4. YE<br>5. GY<br>6. PK<br>7. BU<br>8. RD<br> |

We reserve the right to make technical alterations without prior notice.

Receptacles

\* Length in meters. Standard lead length is 0.5 meters. Consult factory for other lengths.  
 Standard housing material is nickel plated brass.  
 To specify PVC jacketed cable, add "/S717" to the end of the part number.

## 4 and 5-Pin Receptacles, Front Mount, Leads and Solder Cups

- NEMA 1, 3, 4, 6P
- IEC IP68 Protection
- 250 V, 4 A



| Housing Style   | Female Part Number         | Male Part Number           | Features   | Pinout               |
|---|----------------------------|----------------------------|--|----------------------|
| <p><b>FK ..18.25</b></p> <p>Typical panel cutout is 14.3 mm</p> | <p><b>FK 4.4/18.25</b></p> | <p><b>FS 4.4/18.25</b></p> | <p>105 °C, Solder Cup, mates with 4-pin cordsets, 1/4-18 NPT Threads</p> | <p><b>Female</b></p> |
| <p><b>FS ..18.25</b></p> <p>Typical panel cutout is 14.3 mm</p> |                            |                            |  | <p><b>Male</b></p>   |

\* Length in meters. Standard lead length is 0.5 meters. Consult factory for other lengths. Standard housing material is nickel plated brass "FS.."; "FSV.." indicates stainless steel. To specify PVC jacketed cable, add "/S717" to the end of the part number.

We reserve the right to make technical alterations without prior notice.

4 and 5-Pin Receptacles, Front Mount, Leads and Solder Cups

- NEMA 1, 3, 4, 6P
- IEC IP68 Protection
- 250 V, 4 A



We reserve the right to make technical alterations without prior notice.

| Housing Style  | Female Part Number | Male Part Number   | Features   | Pinout                                  |
|--|--------------------|--------------------|--|---|
| <p><b>FK..</b></p> <p>Typical panel cutout is 15.2 mm</p>    | <b>FK 4.4</b>      | <b>FS 4.4</b>      | 105 °C, Solder Cup, mates with 4-pin cordsets, PG 9 Threads        | <p><b>Female</b></p> <p><b>Male</b></p> |
| <p><b>FS..</b></p> <p>Typical panel cutout is 15.2 mm</p>    | <b>FK 4.5</b>      | <b>FS 4.5</b>      | 105 °C, Solder Cup, mates with 5-pin cordsets, PG 9 Threads        | <p><b>Female</b></p> <p><b>Male</b></p> |
| <p><b>FS../14.5</b></p> <p>Typical panel cutout is 21 mm</p> |                    | <b>FS 4.4/14.5</b> | 105 °C, Solder Cup, mates with 4-pin cordsets, 1/2-14 NPSM Threads | <p><b>Male</b></p>                      |
|  |                    | <b>FS 4.5/14.5</b> | 105 °C, Solder Cup, mates with 5-pin cordsets, 1/2-14 NPSM Threads | <p><b>Male</b></p>                      |

Receptacles

## 4, 5 and 6-Wire Receptacles, with Front Lock Nut

- NEMA 1, 3, 4, 6P
- IEC IP68 Protection
- 250 V, 4 A (4 & 5 pole)
- 60 VAC/75 VDC, 2 A (6 pole)



| Housing Style   | Female Part Number   | Male Part Number     | Features   | Pinout                                  |
|---|----------------------|----------------------|--|---|
| <p><b>FKD 4.4*</b></p> <p>Typical panel cutout is 15.2 mm</p> | <b>FKD 4.4*</b>      | <b>FSD 4.4*</b>      | 4x22 AWG, 105 °C, mates with 4-pin cordsets  | <p><b>Female</b></p> <p><b>Male</b></p> |
|   | <b>FKD 4.5*</b>      | <b>FSD 4.5*</b>      | 5x22 AWG, 105 °C, mates with 5-pin cordsets  | <p><b>Female</b></p>                    |
|   | <b>FKD 4.5*/S653</b> | <b>FSD 4.5*/S653</b> | 4x22 AWG, Drain, 105 °C, 5.1 mm OD, mates with 5-pin cordsets, 4 Conductors PVC foil Shielded with Drain Wire to pin 5 | <p><b>Male</b></p>                      |
| <p><b>FSD 6.*</b></p> <p>Typical panel cutout is 15.2 mm</p>  | <b>FKD 6.*</b>       | <b>FSD 6.*</b>       | 6x24 AWG, 105 °C, mates with 6-pin cordsets  | <p><b>Female</b></p> <p><b>Male</b></p> |

We reserve the right to make technical alterations without prior notice.

\* Length in meters. Standard lead length is 0.5 meters. Consult factory for other lengths.  
 Standard housing material is nickel plated brass "FSD."; "FSDV." indicates 316 stainless steel.  
 To specify PVC jacketed cable, add "/S717" to the end of the part number.



## 8, 10 and 12-Wire Receptacles, with Front Lock Nut

- NEMA 1, 3, 4, 6P
- IEC IP68 Protection
- 60 VAC/75 VDC, 2 A



We reserve the right to make technical alterations without prior notice.

| Housing Style   | Female Part Number | Male Part Number | Features  | Pinout                                  |
|---|--------------------|------------------|---|---|
| <p><b>FKD 8-*</b></p> <p>Typical panel cutout is 15.2 mm</p>  | <b>FKD 8-*</b>     | <b>FSD 8-*</b>   | 8x24 AWG, 105 °C, mates with 8-pin cordsets, CSA Approved | <p><b>Female</b></p> <p><b>Male</b></p> |
| <p><b>FKD 10-*</b></p> <p>Typical panel cutout is 15.2 mm</p> | <b>FKD 10-*</b>    | <b>FSD 10-*</b>  | 10x24 AWG, 105 °C, mates with 10-pin cordsets             | <p><b>Female</b></p> <p><b>Male</b></p> |
| <p><b>FKD 12-*</b></p> <p>Typical panel cutout is 15.2 mm</p> | <b>FKD 12-*</b>    | <b>FSD 12-*</b>  | 12x24 AWG, 105 °C, mates with 12-pin cordsets             | <p><b>Female</b></p> <p><b>Male</b></p> |

\* Length in meters. Standard lead length is 0.5 meters. Consult factory for other lengths. Standard housing material is nickel plated brass "FSD.."; "FSDV.." indicates stainless steel. To specify PVC jacketed cable, add "/S717" to the end of the part number.

Receptacles

## 4 and 5-Wire Receptacles, Rear Mount with Leads

- NEMA 1, 3, 4, 6P
- IEC IP68 Protection
- 250 V, 4 A (4 & 5 pole)
- 60 VAC/75 VDC, 2A (6 pole)



| Housing Style  | Female Part Number     | Male Part Number       | Features   | Pinout                                  |
|--|------------------------|------------------------|--|---|
| <p><b>FKFD ..</b></p> <p>Typical panel cutout is 15.3 x 14 mm</p>  | <b>FKFD 4.4-*</b>      | <b>FSFD 4.4-*</b>      | 4x22 AWG, 105 °C, mates with 4-pin cordsets  | <p><b>Female</b></p>                    |
|  | <b>FKFD 4.4-*/S621</b> | <b>FSFD 4.4-*/S621</b> | 4x18 AWG, 105 °C, mates with 4-pin cordsets  | <p><b>Male</b></p>                      |
|  | <b>FKFD 4.5-*</b>      | <b>FSFD 4.5-*</b>      | 5x22 AWG, 105 °C, mates with 5-pin cordsets  | <p><b>Female</b></p>                    |
|  | <b>FKFD 4.5-*/S653</b> | <b>FSFD 4.5-*/S653</b> | 4x22 AWG, Drain, 105 °C, 5.1 mm OD, mates with 5-pin cordsets, 4 Conductors PVC Foil Shielded with Drain Wire to pin 5 | <p><b>Male</b></p>                      |
|  | <b>FKFD 6-*</b>        | <b>FSFD 6-*</b>        | 6x24 AWG, 105 °C, mates with 6-pin cordsets  | <p><b>Female</b></p> <p><b>Male</b></p> |
| <p><b>FSFD ..*</b></p> <p>Typical panel cutout is 15.3 x 14 mm</p> |                        |                        |  |   |

We reserve the right to make technical alterations without prior notice.

\* Length in meters. Standard lead length is 0.5 meters. Consult factory for other lengths.  
 Standard housing material is nickel plated brass "FSFD.."; "FSFDV.." indicates stainless steel.  
 To specify PVC jacketed cable, add "/S717" to the end of the part number.

## 6, 8, 10 and 12-Wire Receptacles, Rear Mount with Leads

- NEMA 1, 3, 4, 6P
- IEC IP68 Protection
- 60 VAC/75 VDC, 2 A



| Housing Style  | Female Part Number    | Male Part Number      | Features  | Pinout  |
|--|-----------------------|-----------------------|---|---|
| <p><b>FKFD ..</b></p> <p>Typical panel cutout is 15.3 x 14 mm</p>  | <b>FKFD 8-*</b>       | <b>FSFD 8-*</b>       | 8x24 AWG, 105 °C, mates with 8-pin cordsets, CSA Approved | <p><b>Female</b></p> <p><b>Male</b></p>   |
|  | <b>FKFD 8-*/S1505</b> | <b>FSFD 8-*/S1505</b> | 8x26 AWG, 105 °C, mates with 8-pin cordsets               | <p>1. WH<br/>2. BN<br/>3. GN<br/>4. YE<br/>5. GY<br/>6. PK<br/>7. BU<br/>8. RD</p>  |
|  | <b>FKFD 10-*</b>      | <b>FSFD 10-*</b>      | 10x24 AWG, 105 °C, mates with 10-pin cordsets             | <p><b>Female</b></p> <p><b>Male</b></p>   |
|  | <b>FKFD 12-*</b>      | <b>FSFD 12-*</b>      | 12x24 AWG, 105 °C, mates with 12-pin cordsets             | <p>1. WH<br/>2. BN<br/>3. GN<br/>4. YE<br/>5. GY<br/>6. PK<br/>7. BU<br/>8. RD<br/>9. OG<br/>10. TN<br/>11. BK<br/>12. VT</p> |
| <p><b>FSFD ..*</b></p> <p>Typical panel cutout is 15.3 x 14 mm</p> |                       |                       |   |   |

We reserve the right to make technical alterations without prior notice.

Receptacles

\* Length in meters. Standard lead length is 0.5 meters. Consult factory for other lengths. Standard housing material is nickel plated brass "FSFD.."; "FSFDV.." indicates stainless steel. To specify PVC jacketed cable, add "/S717" to the end of the part number.

## 4 and 5-Pin Receptacles, Rear Mount with Solder Cups

- NEMA 1, 3, 4, 6P
- IEC IP68 Protection
- 250 V, 4 A (4 & 5 pole)
- 60 VAC/75 VDC, 2 A (6 pole)



| Housing Style   | Female Part Number | Male Part Number | Features  | Pinout                                  |
|---|--------------------|------------------|---|---|
| <p><b>FKFDL ..</b></p> <p>Typical panel cutout is 15.3 x 14 mm</p>  | <b>FKFDL 4.4</b>   | <b>FSFDL 4.4</b> | Accepts 18 AWG max Leads, 105 °C, mates with 4-pin cordsets | <p><b>Female</b></p> <p><b>Male</b></p> |
| <p><b>FKFDL 4.5</b></p> <p>Typical panel cutout is 15.3 x 14 mm</p> | <b>FKFDL 4.5</b>   | <b>FSFDL 4.5</b> | Accepts 18 AWG max Leads, 105 °C, mates with 5-pin cordsets | <p><b>Female</b></p> <p><b>Male</b></p> |
| <p><b>FSFDL ..*</b></p> <p>Typical panel cutout is 15.3 x 14 mm</p> | <b>FKFDL 6</b>     | <b>FSFDL 6</b>   | Accepts 22 AWG max Leads, 105 °C, mates with 6-pin cordsets | <p><b>Female</b></p> <p><b>Male</b></p> |

We reserve the right to make technical alterations without prior notice.

Standard housing material is nickel plated brass "FSFDL.."; "FSFDLV.." indicates stainless steel.

8, 10 and 12-Pin Receptacles, Rear Mount with Solder Cups

- NEMA 1, 3, 4, 6P
- IEC IP68 Protection
- 60 VAC/75 VDC, 2 A



| Housing Style  | Female Part Number    | Male Part Number      | Features   | Pinout               |
|--|-----------------------|-----------------------|--|----------------------|
| <p><b>FKFDL ..</b></p> <p>Typical panel cutout is 15.3 x 14 mm</p>   | <p><b>FKFDL 8</b></p> | <p><b>FSFDL 8</b></p> | <p>Accepts 22 AWG Max Leads, 105 °C, Mates with 8-pin Cordsets</p> | <p><b>Female</b></p> |
| <p><b>FSFDL ..-*</b></p> <p>Typical panel cutout is 15.3 x 14 mm</p> |                       |                       |  | <p><b>Male</b></p>   |

Standard housing material is nickel plated brass "FSFDL.."; "FSFDLV.." indicates stainless steel.

We reserve the right to make technical alterations without prior notice.

Receptacles

## 4, 5, 6 and 8-Pin Receptacles, Rear Mount with PCB Pins

- NEMA 1, 3, 4, 6P
- IEC IP68 Protection
- 250 V, 4 A (4 & 5 pole)
- 60 VAC/75 VDC (6 & 8 pole)



| Housing Style   | Female Part Number | Male Part Number | Features                          | Pinout                                  |
|---|--------------------|------------------|-----------------------------------|---|
| <p><b>FKFD ..</b></p> <p>Typical panel cutout is 15.3 x 14 mm</p> | <b>FKFD 4.4</b>    | <b>FSFD 4.4</b>  | 105 °C, mates with 4-pin cordsets | <p><b>Female</b></p> <p><b>Male</b></p> |
|   | <b>FKFD 4.5</b>    | <b>FSFD 4.5</b>  | 105 °C, mates with 5-pin cordsets | <p><b>Female</b></p> <p><b>Male</b></p> |
| <p><b>FSFD ..</b></p> <p>Typical panel cutout is 15.3 x 14 mm</p> | <b>FKFD 6</b>      | <b>FSFD 6</b>    | 105 °C, mates with 6-pin cordsets | <p><b>Female</b></p> <p><b>Male</b></p> |
|   | <b>FKFD 8</b>      | <b>FSFD 8</b>    | 105 °C, mates with 8-pin cordsets | <p><b>Female</b></p> <p><b>Male</b></p> |

We reserve the right to make technical alterations without prior notice.

Standard housing material is nickel plated brass "FSFD.."; "FSFDV.." indicates stainless steel.

4 and 5-Pin Receptacles, Rear Mount with PCB Pins

- NEMA 1, 3, 4, 6P
- IEC IP68 Protection
- 250 V, 4 A



| Housing Style  | Female Part Number | Male Part Number | Features   | Pinout                                  |
|--|--------------------|------------------|--|---|
| <p><b>FKFDK ..</b></p> <p>Typical panel cutout is 15.3 x 14 mm</p> |                    | <b>FSFDK 4.4</b> | Nickel plated brass, 105 °C, mates with 4-pin cordsets, short pins | <p><b>Male</b></p>                      |
| <p><b>FSFDK ..</b></p> <p>Typical panel cutout is 15.3 x 14 mm</p> | <b>FKFDK 4.5</b>   | <b>FSFDK 4.5</b> | Nickel plated brass, 105 °C, mates with 5-pin cordsets, short pins | <p><b>Female</b></p> <p><b>Male</b></p> |

Standard housing material is nickel plated brass "FSFDK.."; "FSFDKV.." indicates stainless steel.

We reserve the right to make technical alterations without prior notice.

Receptacles

## 4, 5, 6 and 8-Pin Receptacles, Rear Mount with PCB Pins

- Male Receptacles
- NEMA 1, 3, 4, 6P
- IEC IP68 Protection
- 250 V, 4 A (4 & 5 pole)
- 60 VAC/75 VDC, 2 A (6 & 8 pole)



| Housing Style | Male Part Number | Features  | Pinout      |
|---------------|------------------|---|-------------|
|               | WFS 4.4-PCB      | 105 °C, mates with 4-pin cordsets, nickel plated brass housing material | <p>Male</p> |
|               | WFS 4.5-PCB      | 105 °C, mates with 5-pin cordsets, nickel plated brass housing material | <p>Male</p> |
|               | WFS 6-PCB        | 105 °C, mates with 6-pin cordsets, nickel plated brass housing material | <p>Male</p> |
|               | WFS 8-PCB        | 105 °C, mates with 8-pin cordsets, nickel plated brass housing material | <p>Male</p> |

We reserve the right to make technical alterations without prior notice.

### WFS PCB Layout

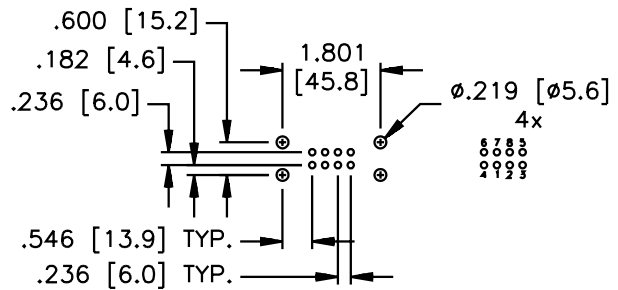
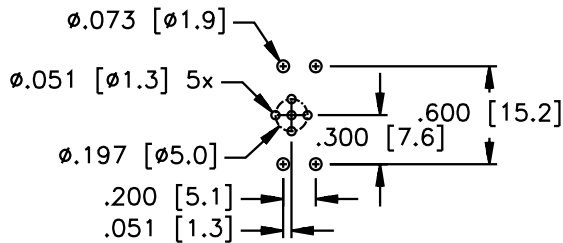



5, 6 and 8-Pin Receptacles, Rear Mount PCB with Header Pins

- NEMA 1, 3, 4, 6 P
- IEC IP 67 Protection
- 250 V, 4 A (5 pole)
- 60 VAC/75 VDC (6 & 8 pole)



We reserve the right to make technical alterations without prior notice.

| Housing Style   | Female Part Number   | Male Part Number     | Features  | Pinout                                  |
|---|----------------------|----------------------|---|---|
| <p><b>WKFD ..PCBH</b></p> <p>Typical panel cutout is 15.3 x 14 mm</p> | <b>WFKD 4.5-PCBH</b> | <b>WFSD 4.5-PCBH</b> | 105 °C, mates with 5-pin cordsets, nickel plated brass housing material | <p><b>Female</b></p> <p><b>Male</b></p> |
| <p><b>WFKD 6-PCBH</b></p>   | <b>WFKD 6-PCBH</b>   | <b>WFSD 6-PCBH</b>   | 105 °C, mates with 6-pin cordsets, nickel plated brass housing material | <p><b>Female</b></p> <p><b>Male</b></p> |
| <p><b>WFSD ..PCBH</b></p> <p>Typical panel cutout is 15.3 x 14 mm</p> | <b>WFKD 8-PCBH</b>   | <b>WFSD 8-PCBH</b>   | 105 °C, mates with 8-pin cordsets, nickel plated brass housing material | <p><b>Female</b></p> <p><b>Male</b></p> |

Receptacles

10 and 12-Pin Receptacles, Rear Mount PCB with Header Pins

- NEMA 1, 3, 4, 6P
- IEC IP 67 Protection
- 60 VAC/75 VDC, 2 A



| Housing Style   | Female Part Number  | Male Part Number    | Features   | Pinout                                  |
|---|---------------------|---------------------|--|---|
| <p><b>WKFD ..PCBH</b></p> <p>Typical panel cutout is 15.3 x 14 mm</p> | <b>WFKD 10-PCBH</b> | <b>WFSD 10-PCBH</b> | 105 °C, mates with 10-pin cordsets, nickel plated brass housing material | <p><b>Female</b></p> <p><b>Male</b></p> |
| <p><b>WFSD ..PCBH</b></p> <p>Typical panel cutout is 15.3 x 14 mm</p> | <b>WFKD 12-PCBH</b> | <b>WFSD 12-PCBH</b> | 105 °C, mates with 12-pin cordsets, nickel plated brass housing material | <p><b>Female</b></p> <p><b>Male</b></p> |

We reserve the right to make technical alterations without prior notice.

## 4 and 5-Pin Circuit Board Mounted Receptacles

- NEMA 1, 3, 4, 6P
- IEC IP68 Protection
- 250 V, 4 A



We reserve the right to make technical alterations without prior notice.

| Housing Style   | Female Part Number | Male Part Number  | Features  | Pinout                                  |
|---|--------------------|-------------------|---|---|
| <p><b>FK..-PCB</b></p>  | <b>FK 4.5-PCB</b>  | <b>FS 4.5-PCB</b> | 105 °C, mates with 5-pin cordsets, nickel plated brass housing material                                       | <p><b>Female</b></p> <p><b>Male</b></p> |
| <p><b>FS..-PCB</b></p>  | <b>FKFDH 4.4</b>   | <b>FSFDH 4.4</b>  | 105 °C, mates with 4-pin cordsets, separate housing and contact carrier, nickel plated brass housing material | <p><b>Female</b></p> <p><b>Male</b></p> |
| <p><b>FKFDH ..</b></p> <p><b>Typical panel cutout is 15.3 x 14 mm</b></p> | <b>FKFDH 4.5</b>   | <b>FSFDH 4.5</b>  | 105 °C, mates with 5-pin cordsets, separate housing and contact carrier, nickel plated brass housing material | <p><b>Female</b></p> <p><b>Male</b></p> |
| <p><b>FSFDH ..</b></p> <p><b>Typical panel cutout is 15.3 x 14 mm</b></p> | <b>FKFDH 4.5</b>   | <b>FSFDH 4.5</b>  | 105 °C, mates with 5-pin cordsets, separate housing and contact carrier, nickel plated brass housing material | <p><b>Female</b></p> <p><b>Male</b></p> |

**FKFDH - Detail**

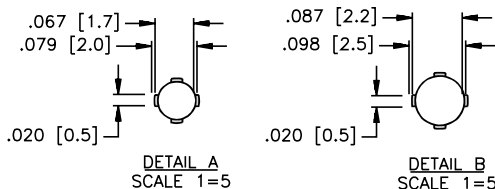

**FSFDH - Detail**

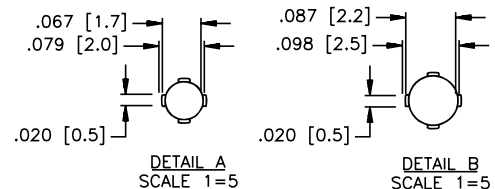

4 and 5-Pin Circuit Board Mounted Receptacles

- NEMA 1, 3, 4, 6P
- IEC IP68 Protection
- 250 V, 4 A



| Housing Style   | Female Part Number | Male Part Number  | Features   | Pinout                                  |
|---|--------------------|-------------------|--|---|
| <p><b>WFKFDH ..</b></p> <p>Typical panel cutout is 12 mm</p>  | <b>WFKFDH 4.4</b>  | <b>WFSFDH 4.4</b> | 105 °C, mates with 4-pin cordsets, separate housing and contact carrier, right angle, nickel plated brass housing material | <p><b>Female</b></p> <p><b>Male</b></p> |
| <p><b>FKFDHOW ..</b></p> <p>Typical panel cutout is 12 mm</p> | <b>WFKFDH 4.5</b>  | <b>WFSFDH 4.5</b> | 105 °C, mates with 5-pin cordsets, separate housing and contact carrier, right angle, nickel plated brass housing material | <p><b>Female</b></p> <p><b>Male</b></p> |
| <p><b>WFSFDH ..</b></p> <p>Typical panel cutout is 12 mm</p>  | <b>FKFDHOW 4.5</b> |                   | 105 °C, mates with 5-pin cordsets, separate housing and contact carrier, reverse key, nickel plated brass housing material | <p><b>Female</b></p>                    |

We reserve the right to make technical alterations without prior notice.

## 5-Wire Receptacles, Front Mount, Reverse Key

- NEMA 1, 3, 4, 6P
- IEC IP68 Protection
- 250 V, 4 A



We reserve the right to make technical alterations without prior notice.

| Housing Style   | Female Part Number       | Male Part Number          | Features   | Pinout   |
|---|--------------------------|---------------------------|--|--|
| <p><b>FKW ..*</b></p> <p>Typical panel cutout is 15.2 mm</p>        | <b>FKW 4.5-*</b>         | <b>FSW 4.5-*</b>          | 4x22, 1x20 AWG, 105 °C, mates with 5-pin Reverse Key Cordset   | <ol style="list-style-type: none"> <li>1. BN</li> <li>2. WH</li> <li>3. BU</li> <li>4. BK</li> <li>5. GN/YE</li> </ol> |
| <p><b>FSW ..</b></p> <p>Typical panel cutout is 15.2 mm</p>         | <b>FKW 4.5-*/S653</b>    | <b>FSW 4.5-*/S653</b>     | 4x22 AWG, Drain 105 °C, 5.1 mm OD, mates with 5-pin Reverse Key Cordset, 4 Conductors PVC Foil Shielded with Drain Wire to pin 5 | <ol style="list-style-type: none"> <li>1. BN</li> <li>2. WH</li> <li>3. BU</li> <li>4. BK</li> <li>5. Drain</li> </ol> |
| <p><b>FKW ..14.5</b></p> <p>Typical panel cutout is 21 mm</p>       | <b>FKW 4.5-*/14.5</b>    | <b>FSW 4.5-*/14.5</b>     | 4x22, 1x20 AWG 105 °C, mates with 5-pin Reverse Key Cordset  | <ol style="list-style-type: none"> <li>1. BN</li> <li>2. WH</li> <li>3. BU</li> <li>4. BK</li> <li>5. GN/YE</li> </ol> |
| <p><b>FSW ..14.5</b></p> <p>Typical panel cutout is 21 mm</p>       | <b>FKW 4.5*/14.5/NPT</b> | <b>FSW 4.5-*/14.5/NPT</b> | 4x22, 1x20 AWG 105 °C, mates with 5-pin Reverse Key Cordset  | <ol style="list-style-type: none"> <li>1. BN</li> <li>2. WH</li> <li>3. BU</li> <li>4. BK</li> <li>5. GN/YE</li> </ol> |
| <p><b>FSW ..14.5/NPT</b></p> <p>Typical panel cutout is 22.5 mm</p> | <b>FKW 4.5*/14.5/NPT</b> | <b>FSW 4.5-*/14.5/NPT</b> | 4x22, 1x20 AWG 105 °C, mates with 5-pin Reverse Key Cordset  |  |

\* Length in meters. Standard lead length is 0.5 meters. Consult factory for other lengths. Standard housing material is nickel plated brass "FSW.."; "FSWV.." indicates stainless steel. To specify PVC jacketed cable, add "/S717" to the end of the part number.

## 5-Wire Receptacles, Front Mount, Reverse Key

- NEMA 1, 3, 4, 6P
- IEC IP68 Protection
- 250 V, 4A



| Housing Style  | Female Part Number | Male Part Number | Features  | Pinout               |
|--|--------------------|------------------|---|----------------------|
| <p><b>FKMW ..</b></p> <p>Typical panel cutout is 15.2 mm</p> | FKMW 4.5-*         |                  | 4x22, 1x20 AWG, 105 °C, mates with 5-pin Reverse Key Cordset, PG 9 threads, rotating coupling nut | <p><b>Female</b></p> |
| <p><b>FKDW ..</b></p> <p>Typical panel cutout is 15.2 mm</p> |                    |                  |   |                      |
| <p><b>FSDW ..</b></p> <p>Typical panel cutout is 15.2 mm</p> | FKDW 4.5-*         | FSDW 4.5-*       | 4x22, 1x20 AWG AWM PVC, 105 °C, mates with 5-pin Reverse Key Cordset, PG 9 threads                | <p><b>Male</b></p>   |

\* Length in meters. Standard lead length is 0.5 meters. Consult factory for other lengths. Standard housing material is nickel plated brass "FSW.."; "FSWV.." indicates stainless steel. To specify PVC jacketed cable, add "/S717" to the end of the part number.

We reserve the right to make technical alterations without prior notice.

5-Wire Receptacles, Rear Mount, Reverse Key

- NEMA 1, 3, 4, 6P
- IEC IP68 Protection
- 250 V, 4 A



| Housing Style   | Female Part Number | Male Part Number | Features   | Pinout               |
|---|--------------------|------------------|--|----------------------|
| <p><b>FKFDW ..</b></p> <p>Typical panel cutout is 15.3 x 14.0 mm</p>  | FKFDW 4.5-*        | FSFDW 4.5-*      | 5x22 AWG, 105 °C, mates with 5-pin Reverse Key Cordset, leads, UL Listed, CSA Approved | <p><b>Female</b></p> |
| <p><b>FSFDW ..</b></p> <p>Typical panel cutout is 15.3 x 14.0 mm</p>  |                    |                  |  |                      |
| <p><b>FKFDLW ..</b></p> <p>Typical panel cutout is 15.3 x 14.0 mm</p> | FKFDLW 4.5         | FSFDLW 4.5       | Accepts 20 AWG Max Leads, 105 °C, mates with 5-pin Reverse Key Cordset, solder cup     | <p><b>Male</b></p>   |
| <p><b>FSFDLW ..</b></p> <p>Typical panel cutout is 15.3 x 14.0 mm</p> |                    |                  |  |                      |

We reserve the right to make technical alterations without prior notice.

\* Length in meters. Standard lead length is 0.5 meters. Consult factory for other lengths. Standard housing material is nickel plated brass. To specify PVC jacketed cable, add "/S717" to the end of the part number.

## 5-Pin Receptacles, Rear Mount, Reverse Key, With PCB Pins

- NEMA 1, 3, 4, 6P
- IEC IP68 Protection
- 250 V, 4 A



| Housing Style   | Female Part Number | Male Part Number | Features  | Pinout               |
|---|--------------------|------------------|---|----------------------|
| <p><b>FKFDW ..</b></p> <p>Typical panel cutout is 15.3 x 14.0 mm</p>  | FKFDW 4.5          | FSFDW 4.5        | 105 °C, mates with 5-pin Reverse Key Cordsets, PCB pins       | <p><b>Female</b></p> |
| <p><b>FSFDW ..</b></p> <p>Typical panel cutout is 15.3 x 14.0 mm</p>  |                    |                  |   |                      |
| <p><b>FSFDKW ..</b></p> <p>Typical panel cutout is 15.3 x 14.0 mm</p> | FKFDKW 4.5         | FSFDKW 4.5       | 105 °C, mates with 5-pin Reverse Key Cordsets, short PCB pins | <p><b>Male</b></p>   |
| <p><b>FKFDKW ..</b></p> <p>Typical panel cutout is 15.3 x 14.0 mm</p> |                    |                  |   |                      |

We reserve the right to make technical alterations without prior notice.

\* Length in meters. Standard lead length is 0.5 meters. Consult factory for other lengths.  
 Standard housing material is nickel plated brass.  
 To specify PVC jacketed cable, add "/S717" to the end of the part number.



## 4 and 5-Wire Receptacles, Back Panel Mount

- NEMA 1, 3, 4, 6P
- IEC IP68 Protection
- 250 V, 4 A



| Housing Style | Female Part Number    | Features                                    | Pinout   |
|---------------|-----------------------|---|--|
|               | <b>FKP 4.4-*</b>      | 4x18 AWG, 105 °C, mates with 4-pin cordsets | 1. BN<br>2. WH<br>3. BU<br>4. BK<br>               |
|               | <b>FKP 4.4-*/S621</b> | 4x18 AWG, 105 °C, mates with 4-pin cordsets | 1. GY1<br>2. GY2<br>3. GY3<br>4. GY4<br>           |
|               | <b>FKP 4.5-*</b>      | 5x18 AWG, 105 °C, mates with 5-pin cordsets | 1. BN<br>2. WH<br>3. BU<br>4. BK<br>5. GY<br>      |
|               | <b>FKP 4.5-*/S621</b> | 5x18 AWG, 105 °C, mates with 5-pin cordsets | 1. GY1<br>2. GY2<br>3. GY3<br>4. GY4<br>5. GY5<br> |

Receptacles

We reserve the right to make technical alterations without prior notice.

\* Length in meters. Standard lead length is 0.5 meters. Consult factory for other lengths. Standard material is nickel plated brass. To specify PVC jacketed cable, add "/S717" to the end of the part number.

- Female to Male Receptacles
- NEMA 1, 3, 4, 6P
- IEC IP68 Protection



| Housing Style   | Part Number            | Features   | Pinout |
|---|------------------------|--|--------|
| <p><b>FKFS ..M12</b></p> <p>Dimensions: <math>\phi.772</math> [19.6], <math>\phi.669</math> [17.0], 1.877 [47.7], 1.157 [29.4], M12x1, M12x1, .687 [17.5], <math>\phi.762</math> [19.3]</p> | <b>FK FS 4.4/M12</b>   | 4-conductor, 80 °C,<br>150 V, 4 A, mates<br>with 4-pin cordsets                |        |
|   | <b>FK FS 4.5/M12</b>   | 5-conductor, 80 °C,<br>150 V, 4 A, mates<br>with 5-pin cordsets                |        |
|   | <b>FKW FSW 4.5/M12</b> | 5-conductor, 80 °C,<br>150 V, 4 A, mates<br>with 5-pin Reverse<br>Key cordsets |        |
|   | <b>FK FS 4.6/M12</b>   | 6-conductor, 80 °C,<br>36 V, 1.5 A, mates<br>with 6-pin cordsets               |        |
|   | <b>FK FS 6/M12</b>     | 6-conductor, 80 °C,<br>36 V, 1.5 A, mates<br>with 6-pin cordsets               |        |
|   | <b>FK FS 8/M12</b>     | 8-conductor, 80 °C,<br>36 V, 1.5 A, mates<br>with 8-pin cordsets               |        |

We reserve the right to make technical alterations without prior notice.

Standard housing material is nickel plated brass "FK FS.."; "FKV FSV.." indicates stainless steel.

4 and 5-Pin Field Wireable Connectors, Standard Key

- IEC IP67 Protection



| Housing Style         | Female Part Number                                   | Male Part Number                                       | Features   | Pinout               |
|-----------------------|--|--|--|----------------------|
| <p><b>B 81..</b></p>  | <p><b>B 8141-0</b><br/><b>B 8241-0</b></p>           | <p><b>BS 8141-0</b><br/><b>BS 8241-0</b></p>           | <p>PBT, Black, PG 7 cable gland, accepts 4-6 mm cable diameter, screw terminals, accepts up to 18 AWG conductors, 85 °C, 250 V, 4 A, mates with standard key 4-pin cordsets and receptacles</p>                    | <p><b>Female</b></p> |
| <p><b>B 82..</b></p>  | <p><b>B 8141-0/PG 9</b><br/><b>B 8241-0/PG 9</b></p> | <p><b>BS 8141-0/PG 9</b><br/><b>BS 8241-0/PG 9</b></p> | <p>PBT, Black, PG 9 cable gland, accepts 6-8 mm cable diameter, screw terminals, accepts up to 18 AWG conductors, 85 °C, 250 V, 4 A, mates with standard key 4-pin cordsets and receptacles</p>                    | <p><b>Male</b></p>   |
| <p><b>BS 81..</b></p> | <p><b>B 8151-0/PG 9</b><br/><b>B 8251-0/PG 9</b></p> | <p><b>BS 8151-0/PG 9</b><br/><b>BS 8251-0/PG 9</b></p> | <p>PBT, Black, PG 9 cable gland, accepts 4-8 mm cable diameter, screw terminals, accepts up to 18 AWG conductors, 85 °C, 60 V, 4 A, mates with standard key 5-pin cordsets and receptacles</p>                     | <p><b>Female</b></p> |
| <p><b>BS 82..</b></p> | <p><b>BM 8151-0/PG 9</b></p>                         |  | <p>PBT, Black, PG 9 cable gland, accepts 6-8 mm cable diameter, screw terminals, accepts up to 18 AWG conductors, metal coupling nut, 85 °C, 60 V, 4 A, mates with standard key 5-pin cordsets and receptacles</p> | <p><b>Male</b></p>   |

We reserve the right to make technical alterations without prior notice.

Field Wireables

• IEC IP67 Protection



| Housing Style         | Female Part Number                     | Male Part Number                         | Features  | Pinout                                  |
|-----------------------|--|--|---|---|
| <p><b>B 81..</b></p>  |  | <b>BS 8157-0/PG 9</b>                    | PBT, Black, PG 9 cable gland accepts 6-8 mm cable diameter, spring clamp accepts up to 20 AWG conductors, 85 °C, 125 V, 4 A, Mates with standard key 5-pin cordsets and receptacles, spring clamp | <p><b>Male</b></p>                      |
|                       | <b>BWS 8141-0</b>                      | <b>BSWS 8141-0</b><br><b>BSWS 8241-0</b> | PBT, Black, PG 9 cable gland accepts 6-8 mm cable diameter, screw terminals accepts up to 18 AWG conductors, 85 °C, 250 V, 4 A, mates with reverse key 4-pin cordsets and receptacles             | <p><b>Female</b></p> <p><b>Male</b></p> |
| <p><b>B 82..</b></p>  | <b>BWS 8151-0</b><br><b>BWS 8251-0</b> | <b>BSWS 8151-0</b><br><b>BSWS 8251-0</b> | PBT, Black, PG 9 cable gland accepts 6-8 mm cable diameter, screw terminals accepts up to 18 AWG conductors, 85 °C, 60 V, 4 A, mates with reverse key 5-pin cordsets and receptacles              | <p><b>Female</b></p> <p><b>Male</b></p> |
| <p><b>BS 81..</b></p> | <b>B 8181-0</b><br><b>B 8281-0</b>     | <b>BS 8181-0</b><br><b>BS 8281-0</b>     | Nylon, Black, PG 9 cable gland accepts 6-8 mm cable diameter, screw terminals accepts up to 18 AWG conductors, 85 °C, 60 VAC/75 VDC, 2 A, mates with standard key 8-pin cordsets and receptacles  | <p><b>Female</b></p> <p><b>Male</b></p> |
| <p><b>BS 82..</b></p> | <b>B 81121-0/PG 9</b>                  | <b>BS 81121-0/PG 9</b>                   | Nylon, Black, PG 9 cable gland accepts 4-8 mm cable diameter, solder cups accept up to 24 AWG conductors, 85 °C, 30 V, 1 A, mates with standard key 12-pin cordsets and receptacles               | <p><b>Female</b></p> <p><b>Male</b></p> |

We reserve the right to make technical alterations without prior notice.

4 and 5-Pin Field Wireable Connectors, Standard with Labels

- IEC IP67 Protection



| Housing Style         | Female Part Number   | Male Part Number   | Features  | Pinout               |
|-----------------------|--|--|---|----------------------|
| <p><b>B 81..</b></p>  | <p><b>B 8141-0/LABEL</b><br/><b>B 8241-0/LABEL</b></p>         | <p><b>BS 8141-0/LABEL</b><br/><b>BS 8241-0/LABEL</b></p>         | <p>PBT, Black, PG 7 cable gland accepts 4-6 mm cable diameter, screw terminals accepts up to 18 AWG conductors, 85 °C, 250 V, 4 A, mates with standard key 4-pin cordsets and receptacles, color coded &amp; numbered pins</p>  | <p><b>Female</b></p> |
| <p><b>B 82..</b></p>  | <p><b>B 8141-0/PG9/LABEL</b><br/><b>B 8241-0/PG9/LABEL</b></p> | <p><b>BS 8141-0/PG9/LABEL</b><br/><b>BS 8241-0/PG9/LABEL</b></p> | <p>PBT, Black, PG 9 cable gland, accepts 6-8 mm cable diameter, screw terminals accepts up to 18 AWG conductors, 85 °C, 250 V, 4 A, mates with standard key 4-pin cordsets and receptacles, color coded &amp; numbered pins</p> | <p><b>Male</b></p>   |
| <p><b>BS 81..</b></p> | <p><b>B 8151-0/PG9/LABEL</b><br/><b>B 8251-0/PG9/LABEL</b></p> | <p><b>BS 8151-0/PG9/LABEL</b><br/><b>BS 8251-0/PG9/LABEL</b></p> | <p>PBT, Black, PG 9 cable gland accepts 4-8 mm cable diameter, screw terminals accepts up to 18 AWG conductors, 85 °C, 60 V, 4 A, mates with standard key 5-pin cordsets and receptacles, color coded &amp; numbered pins</p>   | <p><b>Female</b></p> |
| <p><b>BS 82..</b></p> | <p><b>B 8151-0/PG9/LABEL</b><br/><b>B 8251-0/PG9/LABEL</b></p> | <p><b>BS 8151-0/PG9/LABEL</b><br/><b>BS 8251-0/PG9/LABEL</b></p> | <p>PBT, Black, PG 9 cable gland accepts 4-8 mm cable diameter, screw terminals accepts up to 18 AWG conductors, 85 °C, 60 V, 4 A, mates with standard key 5-pin cordsets and receptacles, color coded &amp; numbered pins</p>   | <p><b>Male</b></p>   |

We reserve the right to make technical alterations without prior notice.

Field Wireables

## 4-Pin Field Wireable Connectors with LEDs

- IEC IP67 Protection



| Housing Style         | Female Part Number   | Male Part Number      | Features  | Pinout               |
|-----------------------|----------------------|-----------------------|---|----------------------|
| <p><b>B 81..</b></p>  | <b>B 8141-P7X2-0</b> | <b>BS 8141-P7X2-0</b> | PBT, Clear, accepts 4-6 mm cable diameter accepts 20-26 AWG (conductor diameter 1-1.6 mm), Insulation Avoidance, 85 °C, 10-30 V, 4 A, mates with standard key 4-pin cordsets and receptacles, 2 LEDs - Signal and Power | <p><b>Female</b></p> |
| <p><b>BS 81..</b></p> |                      |                       |   | <p><b>Male</b></p>   |

### Wiring Diagram

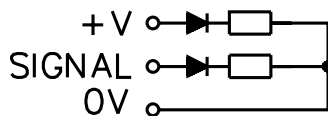

We reserve the right to make technical alterations without prior notice.

4-Pin Field Wireable Connectors, IDC

- Insulation Displacement Technology
- No Conductor Stripping Required
- IEC IP67 Protection



We reserve the right to make technical alterations without prior notice.

| Housing Style                              | Female Part Number | Male Part Number | Features  | Pinout               |
|--|--------------------|------------------|---|----------------------|
| <p><b>B 81..</b></p> <p><b>BS 81..</b></p> | <b>B 8146-0</b>    | <b>BS 8146-0</b> | Nickel Plated Brass, accepts 4-5 mm cable diameter, IDC accepts 26 to 22 AWG conductors, 85 °C, 32 V, 4 A, mates with standard key 4-pin cordsets and receptacles     | <p><b>Female</b></p> |
| <p><b>B 83..</b></p> <p><b>BS 83..</b></p> | <b>B 8346-0</b>    | <b>BS 8346-0</b> | Nickel Plated Brass, accepts 5.5-8.5 mm cable diameter, IDC accepts up to 18 AWG conductors, 85 °C, 50 V, 6 A, mates with standard key 4-pin cordsets and receptacles |                      |
| <p><b>B 82..</b></p> <p><b>BS 82..</b></p> | <b>B 8246-0</b>    | <b>BS 8246-0</b> | Nickel Plated Brass, accepts 4-5 mm cable diameter, IDC accepts 26 to 22 AWG conductors, 85 °C, 32 V, 4 A, mates with standard key 4-pin cordsets and receptacles     | <p><b>Male</b></p>   |

Field Wireables

## 4, 5 and 8-Pin Field Wireable Connectors, Shielded, Screw Terminals

- Screw Terminals
- No Soldering Required
- IEC IP67 Protection



| Housing Style           | Female Part Number                     | Male Part Number                         | Features  | Pinout                                  |
|-------------------------|--|--|---|---|
| <p><b>CMB 81..</b></p>  | <b>CMB 8141-0</b><br><b>CMB 8241-0</b> | <b>CMBS 8141-0</b><br><b>CMBS 8241-0</b> | Nickel Plated Brass, PG 9 cable gland, accepts 6-8 mm cable diameter, screw terminal accepts up to 18 AWG conductors, 85 °C, 250 V, 4 A, Metal, fully shielded Mates with standard key 4-pin cordsets and receptacles | <p><b>Female</b></p> <p><b>Male</b></p> |
| <p><b>CMB 82..</b></p>  | <b>CMB 8151-0</b><br><b>CMB 8251-0</b> | <b>CMB 8151-0</b><br><b>CMB 8251-0</b>   | Nickel Plated Brass, PG 9 cable gland, accepts 6-8 mm cable diameter, screw terminal, accepts up to 18 AWG conductors, 85 °C, 60 V, 4 A, metal, fully shielded Mates with standard key 5-pin cordsets and receptacles | <p><b>Female</b></p> <p><b>Male</b></p> |
| <p><b>CMBS 81..</b></p> |  |  |   | <p><b>Female</b></p> <p><b>Male</b></p> |
| <p><b>CMBS 82..</b></p> | <b>CMB 8181-0</b>                      | <b>CMBS 8181-0</b>                       | Nickel Plated Brass, PG 9 cable gland accepts 6-8 mm cable diameter, screw terminal accepts up to 18 AWG conductors, 85 °C, 60 V, 2 A, metal, fully shielded, mates with standard key 8-pin cordsets and receptacles  | <p><b>Female</b></p> <p><b>Male</b></p> |

We reserve the right to make technical alterations without prior notice.



5-Pin Field Wireable Connectors, Reverse Key

- IEC IP67 Protection



| Housing Style            | Female Part Number   | Male Part Number      | Features  | Pinout               |
|--------------------------|----------------------|-----------------------|---|----------------------|
| <p><b>BMWS 81..</b></p>  | <b>BMWS 8151-0/9</b> | <b>BMSWS 8151-0/9</b> | Nickel Plated Brass, PG 9 cable gland, accepts 6-8 mm cable diameter, screw terminal, accepts up to 18 AWG conductors, 85 °C, 60 V, 4 A, Metal, fully shielded, mates with reverse key 5-pin cordsets and receptacles | <p><b>Female</b></p> |
| <p><b>BMWS 82..</b></p>  |                      |                       |   |                      |
| <p><b>BMSWS 81..</b></p> | <b>BMWS 8251-0/9</b> | <b>BMSWS 8251-0/9</b> | Nickel Plated Brass, PG 9 cable gland, accepts 6-8 mm cable diameter, screw terminal, accepts up to 18 AWG conductors, 85 °C, 60 V, 4 A, metal, fully shielded, mates with reverse key 5-pin cordsets and receptacles | <p><b>Male</b></p>   |
| <p><b>BMSWS 82..</b></p> |                      |                       |   |                      |

We reserve the right to make technical alterations without prior notice.

Field Wireables

## 5-Pin Field Wireable Splitter

- 2 into 1, Parallel, AND Function etc.
- IEC IP67 Protection



| Housing Style           | Female Part Number | Male Part Number   | Features  | Pinout               |
|-------------------------|--------------------|--------------------|---|----------------------|
| <p><b>DBK(S)..</b></p>  | <b>DBK 8151-0</b>  | <b>DBS 8151-0</b>  | Nylon, Black, Nylon coupling nut, accepts 2x3 mm or 2x5 mm cable diameters, screw terminals, accepts up to 18 AWG conductors, 85 °C, 125 V, 4 A, splitter, accepts 2 cables and converts to 1                         | <p><b>Female</b></p> |
| <p><b>DBK(S)M..</b></p> | <b>DBKM 8151-0</b> | <b>DBSM 8151-0</b> | Nylon, nickel plated brass, coupling nut, accepts 4-5 mm cable diameters, screw terminals, accepts up to 18 AWG, conductors, 85 °C, 125 V, 4 A, splitter, accepts 2 cables and converts to 1, straight male connector | <p><b>Male</b></p>   |

We reserve the right to make technical alterations without prior notice.

Conduit Adapters

- Attaches to standard Crouse-Hinds 3/4" Form 8 Conduit Bodies for transition to 5-wire Eurofast® Connectors
- Gasket and 8-32 x 1/2 Mounting Screws included
- IP67 Protection (only when all receptacles are mated or covered with plugs)
- Terminal Strips accept up to 12 AWG Wires



| Housing Style | Part Number | Features  | Pinout | Wiring Diagram |
|---------------|-------------|---|--------|----------------|
|               | CA-1/FK 4.5 | Nylon housing, 80 °C, 250 V, 4 A, attaches to standard conduit body for transition to 5-wire Eurofast connector |        |                |
|               | CA-2/FK 4.5 |   |        |                |

We reserve the right to make technical alterations without prior notice.

Field Wireables

Standard receptacle housing material is nickel plated brass "CA-1(2)/FK 4.5"; "CA-1(2)/FKV 4.5" indicates stainless steel.

- Attaches to standard Crouse-Hinds 3/4" Form 8 Conduit Bodies for transition to 5-wire Eurofast Connectors
- Gasket and 8-32 x 1/2 Mounting Screws included
- IP67 Protection (only when all receptacles are mated or covered with plugs)
- Terminal Strips accept up to 12 AWG Wires



| Housing Style | Part Number  | Features   | Pinout | Wiring Diagram |
|---------------|--------------|--|--------|----------------|
|               | CA-1/FKW 4.5 | Nylon housing, 80 °C, 250 V, 4 A, attaches to standard conduit body for transition to 5-wire Eurofast, reverse key connector |        |                |
|               | CA-2/FKW 4.5 |  |        |                |

Standard receptacle housing material is nickel plated brass "CA-1(2)/FKW 4.5"; "CA-1(2)/FKWV 4.5" indicates stainless steel.

We reserve the right to make technical alterations without prior notice.

## Adapters

- Converts Eurofast to Minifast®
- Rugged Metal Connector
- IP67 Protection



| Housing Style | Part Number          | Features   | Pinout |
|---------------|----------------------|--|--------|
|               | <b>RSM 40-FK 4.4</b> | 80 °C, 250 V, 4 A, female Eurofast to male Minifast adapter, 4-pin |        |
|               | <b>RSM 50-FK 4.5</b> | 80 °C, 250 V, 4 A, female Eurofast to male Minifast adapter, 5-pin |        |

We reserve the right to make technical alterations without prior notice.

eurofast®

## Connector Inserts

- For use in Sensors and Custom Receptacles
- Available with Solder Cups and PCB Pins
- Compatible with standard Eurofast Cordsets



| Housing Style | Part Number                  | Features   | Pinout |
|---------------|------------------------------|--|--------|
|               | <b>EWAS 4.4 (10/BAG)</b>     | Nylon or PUR, accepts up to 20 AWG, 250 V, 4 A, up to 4 conductors, DC applications              |        |
|               | <b>EWAS 4.5 (10/BAG)</b>     | Nylon or PUR, accepts up to 20 AWG, 250 V, 4 A, up to 5 conductors, DC applications              |        |
|               | <b>EWAS 6 (10/BAG)</b>       | Nylon or PUR, accepts up to 24 AWG, 30 VAC/36 VDC, 4 A, up to 6 conductors, DC applications      |        |
|               | <b>EWAS 8 (10/BAG)</b>       | Nylon or PUR, accepts up to 24 AWG, 30 VAC/36 VDC, 1.5 A, up to 8 conductors, DC applications    |        |
|               | <b>EWAK 4 PCB (10/BAG)</b>   | Nylon or PUR, 250 V, 4 A, up to 3 conductors, DC applications                                    |        |
|               | <b>EWAK 4.4 PCB (10/BAG)</b> | Nylon or PUR, 250 V, 4 A, up to 4 conductors, DC applications                                    |        |
|               | <b>EWAK 4.5 PCB (10/BAG)</b> | Nylon or PUR, 250 V, 4 A, up to 5 conductors, DC applications                                    |        |
|               | <b>EWASW 4.5 (10/BAG)</b>    | Reverse key, nylon or PUR, accepts up to 20 AWG, 250 V, 4 A, up to 5 conductors, DC applications |        |

We reserve the right to make technical alterations without prior notice.

Closure Caps

We reserve the right to make technical alterations without prior notice.

eurofast®

| Drawing | Part Number   | Features   |
|---------|---------------|--|
|         | <b>RK-CC</b>  | Nickel plated brass, M12x1 threads, 6" lanyard, mates to male cordsets and receptacles               |
|         | <b>RKV-CC</b> | Stainless steel, M12x1 threads, 6" lanyard, mates to male cordsets and receptacles                   |
|         | <b>RS-CC</b>  | Nickel plated brass, M12x1 threads, 6" lanyard, mates to female cordsets and receptacles             |
|         | <b>RSV-CC</b> | Stainless steel, M12x1 threads, 6" lanyard, mates to female cordsets and receptacles                 |
|         | <b>FK-CC</b>  | Nickel plated brass, M12x1 threads, 6" lanyard with eyelet, mates to male cordsets and receptacles   |
|         | <b>FKV-CC</b> | Stainless steel, M12x1 threads, 6" lanyard with eyelet, mates to male cordsets and receptacles       |
|         | <b>FS-CC</b>  | Nickel plated brass, M12x1 threads, 6" lanyard with eyelet, mates to female cordsets and receptacles |
|         | <b>FSV-CC</b> | Stainless steel, M12x1 threads, 6" lanyard with eyelet, mates to female cordsets and receptacles     |
|         | <b>FKK-CC</b> | Plastic, M12x1 threads, 3" lanyard with eyelet, mates to male cordsets and receptacles               |
|         | <b>FSK-CC</b> | Plastic, M12x1 threads, 3" lanyard with eyelet, mates to female cordsets and receptacles             |

| Drawing | Part Number | Features   |
|---------|-------------|--|
|         | RKK-CC      | Plastic, M12x1 threads, mates to male cordsets and receptacles                           |
|         | RSK-CC      | Plastic, M12x1 threads, mates to female cordsets and receptacles                         |
|         | RK-MC       | Nickel plated brass, M12x1 threads, no lanyard, mates to male cordsets and receptacles   |
|         | RKV-MC      | Stainless steel, M12x1 threads, no lanyard, mates to male cordsets and receptacles       |
|         | RS-MC       | Nickel plated brass, M12x1 threads, no lanyard, mates to female cordsets and receptacles |
|         | RSV-MC      | Stainless steel, M12x1 threads, no lanyard, mates to female cordsets and receptacles     |
|         | VZ3 (8/BAG) | Nylon, mates to VB2 series junction boxes and female cordsets and receptacles            |

We reserve the right to make technical alterations without prior notice.



|                         |            |
|-------------------------|------------|
| <b>Part Number Keys</b> | <b>E2</b>  |
| <b>Cordsets</b>         | <b>E4</b>  |
| <b>Receptacles</b>      | <b>E8</b>  |
| <b>Field Wireables</b>  | <b>E16</b> |
| <b>Adapters</b>         | <b>E17</b> |

**Features**

- 2 to 6 pin
- Up to 4 Amp, 250 Volt rated
- IEC IP67 protection
- NEMA 6P rated
- Low current AC applications



## Cordset Part Number key

Part Number Keys are to assist in IDENTIFICATION ONLY. Consult factory for catalog items not identified.

|   |  |  |
|---|--|--|
| <p><b>1/2" Microfast Cordset</b></p> <p>KB = straight female connector<br/>         WKB = right angle female connector<br/>         SB = straight male connector<br/>         WSB = right angle male connector</p> <p><b>Body Style</b></p> <p>(blank) = standard plug body<br/>         E = large plug body</p> <p><b>Coupling Nut Material</b></p> <p>(blank) = nickel plated brass<br/>         V = stainless steel<br/>         K = nylon</p> <p><b>Number of Wires / AWG / Color Codes</b></p> <p>2 = BN, BU<br/>         3 = GN, RD/BK, RD/WH<br/>         4 = RD/BK, RD/WH, RD, GN<br/>         5 = RD/WH, RD, GN, RD/YE, RD/BK<br/>         6 = RD/WH, RD, GN, RD/YE, RD/BK, RD/BU<br/>         AWG sizes depend on body style and "/S" variety</p> | <div style="border: 1px solid black; padding: 2px; display: inline-block;">WKB</div> <div style="border: 1px solid black; padding: 2px; display: inline-block; margin-left: 10px;">V</div> <div style="border: 1px solid black; padding: 2px; display: inline-block; margin-left: 10px;">3</div> <div style="border: 1px solid black; padding: 2px; display: inline-block; margin-left: 2px;">T</div> <div style="border: 1px solid black; padding: 2px; display: inline-block; margin-left: 5px;">-</div> <div style="border: 1px solid black; padding: 2px; display: inline-block; margin-left: 2px;">*</div> <div style="border: 1px solid black; padding: 2px; display: inline-block; margin-left: 10px;">/S..</div> | <p><b>Varieties</b></p> <p>(blank) = PVC jacket<br/>         /S90 = TPU jacket<br/>         /S90-SP = TPU coil cord<br/>         /S105 = PVC jacket, mechanical shield (braided)<br/>         /S1077 = silicone tubing<br/>         /S1587 = Weldlife®, weld flash immune<br/>         /XOR = irradiated PVC jacket<br/>         /S.. = consult factory, special<br/>         /CS.. = consult factory, special</p> <p><b>Insertion Point of Extension Cable and Second Prefix*</b></p> <p>* Female connector listed first, male connector second<br/>         Example: <b>KB 3T-2-SB 3T</b></p> <p><b>Length in Meters</b></p> |
|---|--|--|

**Plug Options**

T = T barb fitting

### Extension Examples:

Hybrid connector extensions also available. Consult factory.



KB 3 T - 2 SB 3 T



WKB 3 T - 2 SB 3 T

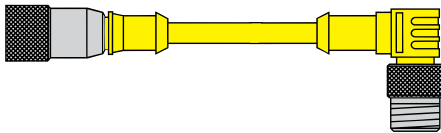

KB 3 T - 2 WSB 3 T

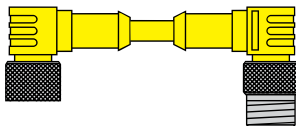

WKB 3 T - 2 WSB 3 T

## Cordset Part Number key

Part Number Keys are to assist in IDENTIFICATION ONLY. Consult factory for catalog items not identified.

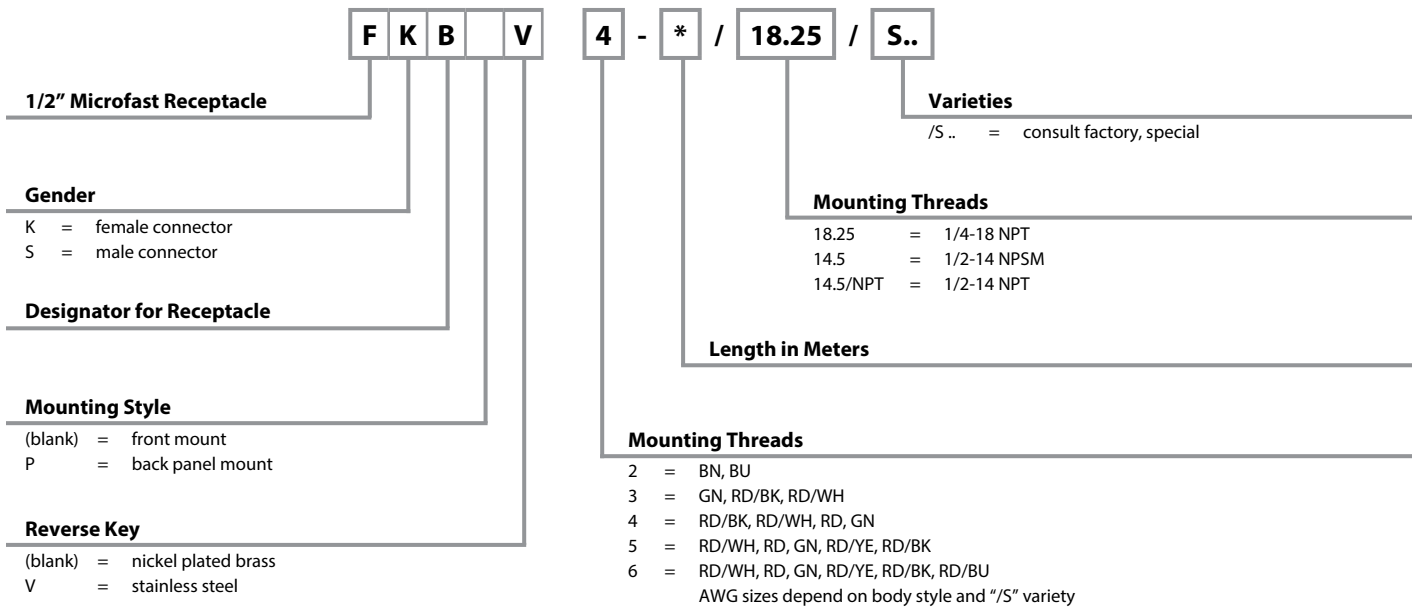

microfast®

## Field Wireable Part Number Key

Part Number Keys are to assist in IDENTIFICATION ONLY. Consult factory for catalog items not identified.

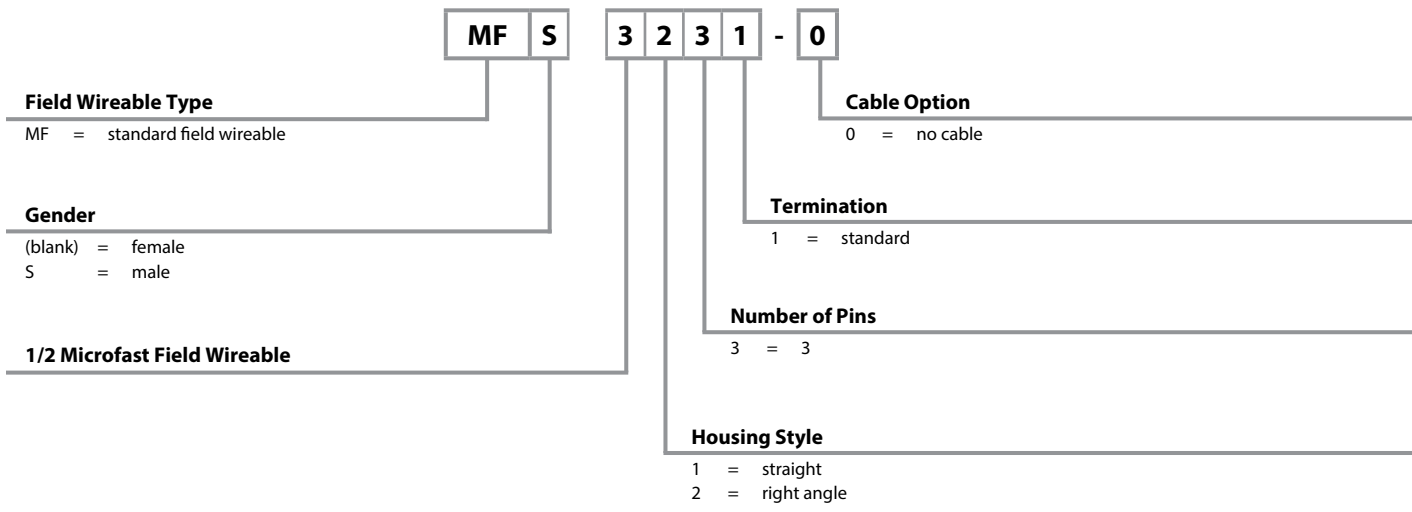

- NEMA 1, 3, 4, 6P
- IEC IP67 Protection
- 250 V, 4 A



| Connector Style        | Female Part Number                            | Male Part Number                              | Features   | Pinout                                 |
|------------------------|---|---|--|--|
| <p><b>WSB ..**</b></p> | <b>KB 3T-*</b><br><b>WKB 3T-*</b>             | <b>SB 3T-*</b><br><b>WSB 3T-*</b>             | ITC/PLTC PVC Yellow, 3x22 AWG, 105 °C, 5.1 mm OD, Cable #RF50531-*M  | <p><b>Female</b></p>                   |
| <p><b>WKB ..**</b></p> | <b>KB 3T-*/S90</b><br><b>WKB 3T-*/S90</b>     | <b>SB 3T-*/S90</b><br><b>WSB 3T-*/S90</b>     | AWM TPU Yellow, 3x18 AWG, 90 °C, 5.3 mm OD, Cable #RF50547-*M, Cut/Abrasion Immune                           |  |
| <p><b>SB ..**</b></p>  | <b>KB 3T-*/S105</b><br><b>WKB 3T-*/S105</b>   | <b>SB 3T-*/S105</b><br><b>WSB 3T-*/S105</b>   | ITC/PLTC PVC Yellow, 3x22 AWG, 105 °C, 6.2 mm OD, Cable #RF50535-*M, Braided Shield                          | <p>1. GN<br/>2. RD/BK<br/>3. RD/WH</p> |
| <p><b>SB ..**</b></p>  | <b>KB 3T-*/S749</b><br><b>WKB 3T-*/S749</b>   | <b>SB 3T-*/S749</b><br><b>WSB 3T-*/S749</b>   | ITC/PLTC PVC Yellow, 2x22 AWG, 105 °C, 5.1 mm OD, Cable #RF50650-*M, 3-pin with 2 conductors                 | <p>1. N/C<br/>2. BK<br/>3. WH</p>      |
| <p><b>WSB ..**</b></p> | <b>KB 3T-*/S1507</b><br><b>WKB 3T-*/S1507</b> | <b>SB 3T-*/S1507</b><br><b>WSB 3T-*/S1507</b> | AWM TPE Grey, 3x22 AWG 105 °C, 4.8 mm OD, Cable #RF52085-*M, Flexlife-20, High Flex - Over 20 million cycles | <p><b>Male</b></p>                     |

We reserve the right to make technical alterations without prior notice.

\* Length in meters. Standard cable lengths are 2, 4, 6, 8 and 10 meters. Consult factory for other lengths.

\*\* Standard coupling nut material is nickel plated brass "KB .."; "KBK .." indicates nylon and "KBV .." indicates stainless steel.

## 4, 5 and 6-Wire Cordsets, Standard Duty

- NEMA 1, 3, 4, 6P
- IEC IP67 Protection
- 250 V, 4 A



We reserve the right to make technical alterations without prior notice.

| Connector Style        | Female Part Number                          | Male Part Number                            | Features   | Pinout                                  |
|------------------------|---|---|--|---|
| <p><b>KB ..**</b></p>  | <b>KB 4T-*</b><br><b>WKB 4T-*</b>           | <b>SB 4T-*</b><br><b>WSB 4T-*</b>           | ITC/PLTC PVC Yellow, 4x22 AWG, 105 °C, 5.3 mm OD, Cable #RF50555-*M, Flexlife®             | <p><b>Female</b></p>                    |
|                        | <b>KB 4T-*/S90</b><br><b>WKB 4T-*/S90</b>   | <b>SB 4T-*/S90</b><br><b>WSB 4T-*/S90</b>   | AWM TPU Yellow, 4x22 AWG, 90 °C, 4.7 mm OD, Cable #RF50614-*M, Cut/Abrasion Immune         |   |
| <p><b>WKB ..**</b></p> | <b>KB 4T-*/S105</b><br><b>WKB 4T-*/S105</b> | <b>SB 4T-*/S105</b><br><b>WSB 4T-*/S105</b> | ITC/PLTC PVC Yellow, 4x22 AWG, 105 °C, 6.2 mm OD, Cable #RF50656-*M, Braided Copper Shield | <p><b>Male</b></p>                      |
|                        | <b>KB 4T-*/S727</b><br><b>WKB 4T-*/S727</b> | <b>SB 4T-*/S727</b><br><b>WSB 4T-*/S727</b> | AWM TPU Grey, 4x22 AWG, 90 °C, 5.1 mm OD, Cable #RF50532-*M, Special Conductor Color Code  |   |
| <p><b>SB ..**</b></p>  | <b>KB 5T-*</b><br><b>WKB 5T-*</b>           | <b>SB 5T-*</b><br><b>WSB 5T-*</b>           | ITC/PLTC PVC Yellow, 5x22 AWG, 105 °C, 5.7 mm OD, Cable #RF50556-*M, Flexlife              | <p><b>Female</b></p> <p><b>Male</b></p> |
|                        | <b>KB 6T-*</b><br><b>WKB 6T-*</b>           | <b>SB 6T-*</b><br><b>WSB 6T-*</b>           | ITC/PLTC PVC Yellow, 6x22 AWG, 105 °C, 6.2 mm OD, Cable #RF51003-*M, Flexlife              |   |
| <p><b>WSB ..**</b></p> |   |   |  | <p><b>Female</b></p> <p><b>Male</b></p> |

\* Length in meters. Standard cable lengths are 2, 4, 6, 8 and 10 meters. Consult factory for other lengths.

\*\* Standard coupling nut material is nickel plated brass "KB .."; "KBK .." indicates nylon and "KBV .." indicates stainless steel.

microfast®

# 1/2" microfast® Connectivity

## 2, 3 and 5-Wire Cordsets, Large Plug Body



- NEMA 1, 3, 4, 6P
- IEC IP67 Protection
- 250 V, 4 A



| Connector Style  | Female Part Number                              | Male Part Number                                | Features  | Pinout   |
|--|---|---|---|--|
| <p><b>KBE ..**</b><br/>1.911 [48.5]<br/>0.551 [14.0]<br/>1/2-20UNF</p>                   | <b>KBE 2T-*</b><br><b>WKBE 2T-*</b>             | <b>SBE 2T-*</b><br><b>WSBE 2T-*</b>             | ITC/PLTC PVC Yellow, 2x18 AWG, 105 °C, 6.2 mm OD, Cable #RF50511-*M, Flexlife®                    | <p><b>Female</b></p> <p><b>Male</b></p>  |
| <p><b>WKBE ..**</b><br/>1.713 [43.5]<br/>1.260 [32.0]<br/>0.551 [14.0]<br/>1/2-20UNF</p> | <b>KBE 3T-*</b><br><b>WKBE 3T-*</b>             | <b>SBE 3T-*</b><br><b>WSBE 3T-*</b>             | ITC/PLTC PVC Yellow, 3x18 AWG, 105 °C, 6.2 mm OD, Cable #RF50520-*M, Flexlife                     | <p><b>Female</b></p> <p><b>Male</b></p>  |
| <p><b>SBE ..**</b><br/>2.173 [55.2]<br/>0.551 [14.0]<br/>1/2-20UNF</p>                   | <b>KBE 3T-*/S600</b><br><b>WKBE 3T-*/S600</b>   | <b>SBE 3T-*/S600</b><br><b>WSBE 3T-*/S600</b>   | SJOOW CPE Yellow, 3x18 AWG, 105 °C, 8.0 mm OD, Cable #RF50658-*M, Weld Flash Immune, Flame Immune | <p>1. GN<br/>2. RD/BK<br/>3. RD/WH</p> <p><b>Female</b></p> <p><b>Male</b></p>                           |
| <p><b>SBE ..**</b><br/>2.173 [55.2]<br/>0.551 [14.0]<br/>1/2-20UNF</p>                   | <b>KBE 3T-*/S1587</b><br><b>WKBE 3T-*/S1587</b> | <b>SBE 3T-*/S1587</b><br><b>WSBE 3T-*/S1587</b> | ITC/PLTC TPE Yellow, 3x18 AWG, 105 °C, 6.2 mm OD, Cable #RF50957-*M, Weldlife, Weld Flash Immune  | <p><b>Female</b></p> <p><b>Male</b></p>  |
| <p><b>WKBE ..**</b><br/>1.713 [43.5]<br/>1.574 [40.0]<br/>0.551 [14.0]<br/>1/2-20UNF</p> | <b>KBE 5T-*</b><br><b>WKBE 5T-*</b>             | <b>SBE 5T-*</b><br><b>WSBE 5T-*</b>             | ITC/PLTC PVC Yellow, 5x18 AWG, 105 °C, 7.6 mm OD, Cable #RF50521-*M, Flexlife                     | <p><b>Female</b></p> <p><b>Male</b></p>  |
| <p><b>WSBE ..**</b><br/>1.713 [43.5]<br/>1.574 [40.0]<br/>0.551 [14.0]<br/>1/2-20UNF</p> | <b>KBE 5T-*/S600</b><br><b>WKBE 5T-*/S600</b>   | <b>SBE 5T-*/S600</b><br><b>WSBE 5T-*/S600</b>   | SJOOW CPE Yellow, 5x18 AWG, 105 °C, 9.4 mm OD, Cable #RF50659-*M, Weld Flash Immune, Flame Immune | <p>1. RD/WH<br/>2. RD/BU<br/>3. GN<br/>4. RD/OG<br/>5. RD/BK</p> <p><b>Female</b></p> <p><b>Male</b></p> |
| <p><b>WSBE ..**</b><br/>1.713 [43.5]<br/>1.574 [40.0]<br/>0.551 [14.0]<br/>1/2-20UNF</p> | <b>KBE 5T-*/S1587</b><br><b>WKBE 5T-*/S1587</b> | <b>SBE 5T-*/S1587</b><br><b>WSBE 5T-*/S1587</b> | ITC/PLTC TPE Yellow, 5x18 AWG, 105 °C, 7.6 mm OD, Cable #RF50958-*M, Weldlife, Weld Flash Immune  | <p><b>Female</b></p> <p><b>Male</b></p>  |

We reserve the right to make technical alterations without prior notice.

\* Length in meters. Standard cable lengths are 2, 4, 6, 8 and 10 meters. Consult factory for other lengths.

\*\* Standard coupling nut material is nickel plated brass "KB .."; "KBK .." indicates nylon and "KBV .." indicates stainless steel.

## 3 and 4-Wire Spiral Cordsets, Standard Duty

- NEMA 1, 3, 4, 6P
- IEC IP67 Protection
- 250 V, 4 A



We reserve the right to make technical alterations without prior notice.

| Connector Style          | Female Part Number  | Male Part Number  | Features   | Pinout   |
|--------------------------|---|---|--|--|
| <p><b>KB ..SP**</b></p>  | <p><b>KB 3T-3.3/S90-SP</b><br/><b>WKB 3T-3.3/S90-SP</b></p>           | <p><b>SB 3T-3.3/S90-SP</b><br/><b>WSB 3T-3.3/S90-SP</b></p>           | <p>AWM TPU Yellow, 3x22 AWG, 90 °C, 250 V, 4 A, 5.1 mm OD, for repetitive motion, 3-wire applications</p>              | <p><b>Female</b></p> <p>1. GN<br/>2. RD/BK<br/>3. RD/WH</p> <p><b>Male</b></p>     |
| <p><b>WKB ..SP**</b></p> |   |   |  |  |
| <p><b>SB ..SP**</b></p>  | <p><b>KB 4T-3.3/S90-SP/S727</b><br/><b>WKB 4T-3.3/S90-SP/S727</b></p> | <p><b>SB 4T-3.3/S90-SP/S727</b><br/><b>WSB 4T-3.3/S90-SP/S727</b></p> | <p>AWM TPU Grey, 4x22 AWG, 90 °C, 250 V, 4 A, 5.1 mm OD, for repetitive motion, 3-wire AC flow sensor applications</p> | <p><b>Female</b></p> <p>1. BN<br/>2. WH<br/>3. BU<br/>4. BK</p> <p><b>Male</b></p> |
| <p><b>WSB ..SP**</b></p> |   |   |  |  |

\*\* Standard coupling nut material is nickel plated brass "KB"(WKB)"; "KBV(WKBV)" indicates stainless steel.

microfast®

| Mounting Style            | Image | Panel Thread Types   | Page |
|---------------------------|-------|--|------|
| <p><b>Front Mount</b></p> |       | <p><u>1/2-14 NPSM</u> <span style="float: right;"><u>E9</u></span></p> <p><u>1/2-14 NPT</u> <span style="float: right;"><u>E11</u></span></p> <p><u>1/4-18 NPT</u> <span style="float: right;"><u>E13</u></span></p> |      |
| <p><b>Rear Mount</b></p>  |       | <p><u>11/16-24 UNEF</u> <span style="float: right;"><u>E15</u></span></p> <p><u>Bulkhead Feed-thru</u> <span style="float: right;"><u>E15</u></span></p>   |      |

We reserve the right to make technical alterations without prior notice.



## 2, 3 and 4-Wire Receptacles, Front Mount, 1/2-14 NPSM Threads

- NEMA 1, 3, 4, 6P
- IEC IP67 Protection
- 250 V, 4 A



We reserve the right to make technical alterations without prior notice.

| Housing Style   | Female Part Number       | Male Part Number         | Features            | Pinout  |
|---|--------------------------|--------------------------|---------------------|---|
| <p><b>FKB ...</b></p> <p>Typical panel cutout 22.5 mm</p> | <b>FKB 2-*/14.5</b>      | <b>FSB 2-*/14.5</b>      | 2x18 AWG,<br>105 °C | <p><b>Female</b></p> <p><b>Male</b></p>                   |
|   | <b>FKB 3-*/14.5</b>      | <b>FSB 3-*/14.5</b>      | 3x22 AWG,<br>105 °C | <p><b>Female</b></p>                                      |
|   | <b>FKB 3-*/14.5/S690</b> | <b>FSB 3-*/14.5/S690</b> | 3x18 AWG,<br>105 °C | <p>1. GN<br/>2. RD/BK<br/>3. RD/WH</p> <p><b>Male</b></p> |
| <p><b>FSB ...</b></p> <p>Typical panel cutout 22.5 mm</p> | <b>FKB 4-*/14.5</b>      | <b>FSB 4-*/14.5</b>      | 4x22 AWG,<br>105 °C | <p><b>Female</b></p> <p><b>Male</b></p>                   |

microfast®

\* Length in meters. Standard lead length is 0.5 meters. Consult factory for other lengths.  
Standard housing material is nickel plated brass. "FSB...".  
To specify PVC jacketed cable, add "/S717" to the end of the part number.

- NEMA 1, 3, 4, 6P
- IEC IP67 Protection
- 250 V, 4 A



| Housing Style   | Female Part Number       | Male Part Number         | Features            | Pinout   |
|---|--------------------------|--------------------------|---------------------|--|
| <p><b>FKB ...</b></p> <p>Typical panel cutout 22.5 mm</p> | <b>FKB 5-*/14.5</b>      | <b>FSB 5-*/14.5</b>      | 5x22 AWG,<br>105 °C | <p><b>Female</b></p> <p>1. RD/WH<br/>2. RD<br/>3. GN<br/>4. RD/YE<br/>5. RD/BK</p>                                 |
| <p><b>FKB ...</b></p> <p>Typical panel cutout 22.5 mm</p> | <b>FKB 5-*/14.5/S690</b> | <b>FSB 5-*/14.5/S690</b> | 5x18 AWG,<br>105 °C | <p><b>Male</b></p>   |
| <p><b>FSB ...</b></p> <p>Typical panel cutout 22.5 mm</p> | <b>FKB 6-*/14.5</b>      | <b>FSB 6-*/14.5</b>      | 6x22 AWG,<br>105 °C | <p><b>Female</b></p> <p>1. RD/WH<br/>2. RD<br/>3. GN<br/>4. RD/YE<br/>5. RD/BK<br/>6. RD/BU</p> <p><b>Male</b></p> |

We reserve the right to make technical alterations without prior notice.

\* Length in meters. Standard lead length is 0.5 meters. Consult factory for other lengths. Standard housing material is nickel plated brass.. "FSB ..". To specify PVC jacketed cable, add "/S717" to the end of the part number.

## 2, 3 and 4-Wire Receptacles, Front Mount, 1/2-14 NPT Threads

- NEMA 1, 3, 4, 6P
- IEC IP67 Protection
- 250 V, 4 A



We reserve the right to make technical alterations without prior notice.

| Housing Style   | Female Part Number      | Male Part Number        | Features            | Pinout   |
|---|-------------------------|-------------------------|---------------------|--|
| <p><b>FKB ...</b></p> <p>Typical panel cutout 22.5 mm</p> | <b>FKB 2-*/14.5/NPT</b> | <b>FSB 2-*/14.5/NPT</b> | 2x18 AWG,<br>105 °C | <p><b>Female</b></p> <p><b>Male</b></p> <p>1. BN<br/>2. BU</p>                           |
| <p><b>FSB ...</b></p> <p>Typical panel cutout 22.5 mm</p> | <b>FKB 3-*/14.5/NPT</b> | <b>FSB 3-*/14.5/NPT</b> | 3x22 AWG,<br>105 °C | <p><b>Female</b></p> <p><b>Male</b></p> <p>1. GN<br/>2. RD/BK<br/>3. RD/WH</p>           |
| <p><b>FSB ...</b></p> <p>Typical panel cutout 22.5 mm</p> | <b>FKB 4-*/14.5/NPT</b> | <b>FSB 4-*/14.5/NPT</b> | 4x22 AWG,<br>105 °C | <p><b>Female</b></p> <p><b>Male</b></p> <p>1. RD/BK<br/>2. RD/WH<br/>3. RD<br/>4. GN</p> |

microfast®

\* Length in meters. Standard lead length is 0.5 meters. Consult factory for other lengths.  
Standard housing material is nickel plated brass. "FSB."  
To specify PVC jacketed cable, add "/S717" to the end of the part number.

- NEMA 1, 3, 4, 6P
- IEC IP67 Protection
- 250 V, 4 A



| Housing Style   | Female Part Number      | Male Part Number             | Features            | Pinout   |
|---|-------------------------|------------------------------|---------------------|--|
| <p><b>FKB ...</b></p> <p>Typical panel cutout 22.5 mm</p> | <b>FKB 5-*/14.5/NPT</b> | <b>FSB 5-*/14.5/NPT</b>      | 5x22 AWG,<br>105 °C | <p><b>Female</b></p> <p>1. RD/WH<br/>2. RD<br/>3. GN<br/>4. RD/YE<br/>5. RD/BK</p> <p><b>Male</b></p>              |
|   |                         | <b>FSB 5-*/14.5/NPT/S690</b> | 5x18 AWG,<br>105 °C | <p><b>Male</b></p>   |
| <p><b>FSB ...</b></p> <p>Typical panel cutout 22.5 mm</p> | <b>FKB 6-*/14.5/NPT</b> | <b>FSB 6-*/14.5/NPT</b>      | 6x22 AWG,<br>105 °C | <p><b>Female</b></p> <p>1. RD/WH<br/>2. RD<br/>3. GN<br/>4. RD/YE<br/>5. RD/BK<br/>6. RD/BU</p> <p><b>Male</b></p> |

We reserve the right to make technical alterations without prior notice.

\* Length in meters. Standard lead length is 0.5 meters. Consult factory for other lengths. Standard housing material is nickel plated brass..“FSB..”. To specify PVC jacketed cable, add “/S717” to the end of the part number.

## 2 and 3-Wire Receptacles, Front Mount, 1/4-18 NPT Threads

- NEMA 1, 3, 4, 6P
- IEC IP67 Protection
- 250 V, 4 A



| Housing Style         | Female Part Number        | Male Part Number          | Features            | Pinout                                  |
|-----------------------|---------------------------|---------------------------|---------------------|---|
| <p><b>FKB ...</b></p> | <b>FKB 2-*/18.25</b>      | <b>FSB 2-*/18.25</b>      | 2x18 AWG,<br>105 °C | <p><b>Female</b></p> <p><b>Male</b></p> |
|                       | <b>FKB 3-*/18.25</b>      | <b>FSB 3-*/18.25</b>      | 3x22 AWG,<br>105 °C | <p><b>Female</b></p>                    |
|                       | <b>FKB 3-*/18.25/S690</b> | <b>FSB 3-*/18.25/S690</b> | 3x18 AWG<br>105 °C  | <p><b>Female</b></p>                    |
| <p><b>FSB ...</b></p> |                           | <b>FSB 3-*/18.25/S649</b> | 3x22 AWG<br>105 °C  | <p><b>Female</b></p>                    |
|                       | <b>FKB 3-*/18.25/S662</b> | <b>FSB 3-*/18.25/S662</b> | 3x18 AWG<br>105 °C  | <p><b>Male</b></p>                      |
|                       |                           | <b>FSB 3-*/18.25/S881</b> | 3x22 AWG<br>105 °C  | <p><b>Male</b></p>                      |

We reserve the right to make technical alterations without prior notice.

microfast®

\* Length in meters. Standard lead length is 0.5 meters. Consult factory for other lengths.  
 Standard housing material is nickel plated brass. "FSB ..". "FSBV.." indicates stainless steel housing.  
 To specify PVC jacketed cable, add "/S717" to the end of the part number.

# 1/2" microfast® Connectivity

## 4, 5 and 6-Wire Receptacles, Front Mount, 1/4-18 NPT Threads



- NEMA 1, 3, 4, 6P
- IEC IP67 Protection
- 250 V, 4 A



| Housing Style  | Female Part Number        | Male Part Number          | Features            | Pinout  |
|--|---------------------------|---------------------------|---------------------|---|
| <p><b>FKB ...</b></p> <p>Typical panel cutout is 14.3 mm</p> |                           | <b>FSB 4-*/18.25/S621</b> | 4x18 AWG,<br>105 °C | <p><b>Female</b></p>  |
|  | <b>FKB 4-*/18.25</b>      | <b>FSB 4-*/18.25</b>      | 4x22 AWG,<br>105 °C | <p>1. RD/BK<br/>2. RD/WH<br/>3. RD<br/>4. GN</p> <p><b>Male</b></p>                             |
|  |                           | <b>FSB 4-*/18.25/S727</b> | 4x22 AWG,<br>105 °C | <p>1. BN<br/>2. BU<br/>3. BK<br/>4. WH</p>  |
|  |                           |                           |                     |   |
| <p><b>FSB ...</b></p> <p>Typical panel cutout is 14.3 mm</p> | <b>FKB 5-*/18.25</b>      | <b>FSB 5-*/18.25</b>      | 5x22 AWG,<br>105 °C | <p>1. RD/WH<br/>2. RD<br/>3. GN<br/>4. RD/YE<br/>5. RD/BK</p> <p><b>Female</b></p>              |
|  | <b>FKB 5-*/18.25/S690</b> | <b>FSB 5-*/18.25/S690</b> | 5x18 AWG,<br>105 °C | <p><b>Male</b></p>  |
| <p><b>FSB ...</b></p> <p>Typical panel cutout is 14.3 mm</p> | <b>FKB 6-*/18.25</b>      | <b>FSB 6-*/18.25</b>      | 6x22 AWG, 105 °C    | <p>1. RD/WH<br/>2. RD<br/>3. GN<br/>4. RD/YE<br/>5. RD/BK<br/>6. RD/BU</p> <p><b>Female</b></p> |
|  |                           |                           |                     | <p><b>Male</b></p>  |

We reserve the right to make technical alterations without prior notice.

\* Length in meters. Standard lead length is 0.5 meters. Consult factory for other lengths.  
Standard housing material is nickel plated brass. "FSB ..". "FSBV.." indicates stainless steel housing.  
To specify PVC jacketed cable, add "/S717" to the end of the part number.

## 3 and 5-Wire Female Receptacles, Back Panel Mount, 11/16-24 Threads

- NEMA 1, 3, 4, 6P
- IEC IP67 Protection
- 250 V, 4 A



| Housing Style   | Female Part Number | Features         | Pinout               |
|---|--------------------|------------------|----------------------|
| <p><b>FKBP ...</b></p> <p>Recommended panel thickness is 5.1 mm and typical panel cutout is 17.5 x 3.2 x 1.6 mm</p> | <b>FKBP 3-*</b>    | 3x18 AWG, 105 °C | <p><b>Female</b></p> |
|   | <b>FKBP 5-*</b>    | 5x18 AWG, 105 °C | <p><b>Female</b></p> |

Standard housing material is nickel plated brass.

microfast®

## 3, 4 and 5-Wire Shielded Bulkhead Feed-Thru Receptacles

- NEMA 1, 3, 4, 6P
- IEC IP67 Protection
- 250 V, 4 A



| Housing Style  | Part Number      | Features      | Pinout               |
|--|------------------|---------------|----------------------|
| <p><b>FKB FSB ..</b></p> <p>Recommended panel cutout thickness is 5.1 mm and typical panel cutout is 12.5 or 15.9 mm</p> | <b>FKB FSB 3</b> | 3-pin, 105 °C | <p><b>Female</b></p> |
|  | <b>FKB FSB 4</b> | 4-pin, 105 °C | <p><b>Female</b></p> |
|  | <b>FKB FSB 5</b> | 5-pin, 105 °C | <p><b>Female</b></p> |

Standard housing material is nickel plated brass.

We reserve the right to make technical alterations without prior notice.

- NEMA 1, 3, 4, 6P
- IEC IP67 Protection



| Housing Style            | Female Part Number | Male Part Number  | Features   | Pinout               |
|--------------------------|--------------------|-------------------|--|----------------------|
| <p><b>MF 3131-0</b></p>  | <b>MF 3131-0</b>   | <b>MFS 3131-0</b> | PBT, black, PG 7 cable diameter gland, accepts 4-6 mm cable diameter, screw terminals, accepts up to 18 AWG conductor, 85 °C, 250 V, 4 A, mates with 3-wire cordsets and receptacles | <p><b>Female</b></p> |
| <p><b>MF 3231-0</b></p>  |                    |                   |  |                      |
| <p><b>MFS 3131-0</b></p> | <b>MF 3231-0</b>   | <b>MFS 3231-0</b> | PBT, black, PG 7 cable diameter gland, accepts 4-6 mm cable diameter, screw terminals, accepts up to 18 AWG conductor, 85 °C, 250 V, 4 A, mates with 3-wire cordsets and receptacles | <p><b>Male</b></p>   |
| <p><b>MFS 3231-0</b></p> |                    |                   |  |                      |

We reserve the right to make technical alterations without prior notice.



## Adapters

| Housing Style                          | Part Number        | Features  | Pinout  |
|--|--------------------|---|---|
| <p>Typical panel cutout is 22.5 mm</p> | <b>B3131-*</b>     | Nickel plated brass, 3x26 AWG leads, 80 °C, 250 V, 4 A, Mates with 3-pin cordsets, 1/2-14 NPSM thread | <p>1. GN<br/>2. BN<br/>3. BU</p>                              |
|  | <b>B3141-*</b>     | Nickel plated brass, 4x22 AWG leads, 80 °C, 250 V, 4 A, Mates with 4-pin cordsets, 1/2-14 NPSM thread | <p>1. RD/BK<br/>2. RD/WH<br/>3. RD<br/>4. GN</p>              |
|  | <b>B3151-*</b>     | Nickel plated brass, 5x26 AWG leads, 80 °C, 250 V, 4 A, Mates with 5-pin cordsets, 1/2-14 NPSM thread | <p>1. RD/WH<br/>2. RD<br/>3. GN<br/>4. RD/YE<br/>5. RD/BK</p> |
| <p>Typical panel cutout is 22.5 mm</p> | <b>B3131-PG9-*</b> | Nickel plated brass, 3x26 AWG leads, 80 °C, 250 V, 4 A, Mates with 3-pin cordsets, PG 9 thread        | <p>1. GN<br/>2. BN<br/>3. BU</p>                              |
|  | <b>B3141-PG9-*</b> | Nickel plated brass, 4x22 AWG leads, 80 °C, 250 V, 4 A, Mates with 4-pin cordsets, PG 9 thread        | <p>1. RD/BK<br/>2. RD/WH<br/>3. RD<br/>4. GN</p>              |
|  | <b>B3151-PG9-*</b> | Nickel plated brass, 5x26 AWG leads, 80 °C, 250 V, 4 A, Mates with 5-pin cordsets, PG 9 thread        | <p>1. RD/WH<br/>2. RD<br/>3. GN<br/>4. RD/YE<br/>5. RD/BK</p> |

We reserve the right to make technical alterations without prior notice.

microfast®

Accessories

- For use in Sensors and Custom Receptacles
- Compatible with Standard Microfast Cordsets



| Housing Style | Part Number            | Features   | Pinout             |
|---------------|------------------------|--|--------------------|
|               | <b>ESBW 3 (10/BAG)</b> | Nylon solder cup, accepts up to 22 AWG, 80 °C, 250 V, 4 A, up to 3 conductors      | <p><b>Male</b></p> |
|               | <b>ESBW 4 (10/BAG)</b> | Nylon solder cup, accepts up to 22 AWG, 80 °C, 250 V, 4 A, up to 4 conductors      | <p><b>Male</b></p> |
|               | <b>ESBW 5 (10/BAG)</b> | Nylon solder cup, accepts up to 22 AWG, 80 °C, 250 V, 4 A, up to 5 conductors      | <p><b>Male</b></p> |
|               | <b>SB-CC (10/BAG)</b>  | Polypropylene closer cap, mates to female cordsets, receptacles and junction boxes |                    |

We reserve the right to make technical alterations without prior notice.

|                         |            |
|-------------------------|------------|
| <b>Part Number Keys</b> | <b>F2</b>  |
| <b>Cordsets</b>         | <b>F6</b>  |
| <b>Receptacles</b>      | <b>F24</b> |
| <b>Field Wireables</b>  | <b>F48</b> |
| <b>Tees</b>             | <b>F53</b> |
| <b>Closure Caps</b>     | <b>F60</b> |
| <b>Accessories</b>      | <b>F63</b> |

**Features**

- 7/8-16, 1-16 and 1 1/8-16 UN thread connectors
- 7/8" available in 2 to 6-pin
- 1" available in 6 to 8-pin
- 1 1/8" available in 9, 10, 12 and 19-pin
- Up to 10 Amp, 600 Volt rated
- Limited power and control applications



**Cordset Part Number key**

Part Number Keys are to assist in IDENTIFICATION ONLY. Consult factory for catalog items not identified.



**7/8", 1" & 1 1/8" Minifast Cordset**

- R = straight
- W = right angle

**Gender**

- K = female connector, female threads
- S = male connector, male threads
- Y = male connector, female threads
- X = female connector, male threads

**Coupling Nut Material**

- (blank) = nylon
- M = nickel plated brass
- V = stainless steel (hex on 1", 1 1/8" and knurl on 7/8")
- VH = stainless steel (hex on 7/8")

**Insertion Point of Extension Cable and Second Prefix\***

\* Male connector listed first, female connector second  
 Example: **RSM RKM 40-2M**

**Varieties**

- (blank) = PVC jacket
- /S90 = TPU jacket
- /S90-SP = TPU coil cord
- /S101 = Flexlife-20, high flex cable
- /S529 = yellow TPU jacket, braided shield, PVC inner jacket
- /S600 = CPE, rubber jacket
- /S824 = yellow PLTC
- /S1077 = silicone tubing
- /S1587 = TPE, Weldlife
- /S.. = consult factory, special
- /CS.. = consult factory, special
- /S760 = black cable, black mold body
- /S771 = black cable, black mold body

**Length in Meters**

**Number of Wires / AWG / Color Codes**

- 20 = 2x18 AWG BN, BU
- 26 = 2x16 AWG WH, BK
- 28A = 2x18 AWG WH, BK
- 30 = 3x18 AWG GN/YE, BN, BU
- 31 = 3x18 AWG BK, BN, BU
- 35 = 3x16 AWG GN, RD/BK, RD/WH
- 36 = 3x16 AWG GN, BK, WH
- 38A = 3x18 AWG GN, BK, WH
- 311 = 3x18 AWG GN, RD/BK, RD/WH
- 40 = 4x18 AWG BN, WH, BU, BK
- 46 = 4x16 AWG BK, WH, RD, GN
- 47 = 4x16 AWG BN, WH, BU, GN/YE
- 48A = 4x18 AWG BK, WH, RD, GN
- 50 = 5x18 AWG BK, BU, GN/YE, BN, WH
- 55 = 5x16 AWG RD/WH, RD/BU, GN, RD/OG, RD/BK
- 56 = 5x16 AWG WH, RD, GN, OG, BK
- 58A = 5x18 AWG WH, RD, GN, OG, BK
- 511 = 5x18 AWG RD/WH, RD/BU, GN, RD/OG, RD/BK
- 61 = 6x18 AWG GN, WH, BU, GY, YE, BN
- 66 = 6x16 AWG WH, RD, GN, OG, BK, BU
- 68A = 6x18 AWG WH, RD, GN, OG, BK, BU
- 6B6 = 6x16 AWG OG, BU, BK, WH, RD, GN
- 76 = 7x16 AWG WH/BK, BK, WH, RD, OG, BU, GN
- 86 = 8x16 AWG OG, BU, WH/BK, BK, WH, RD, GN, RD/BK
- 96 = 9x16 AWG OG, BU, RD/BK, GN/BK, WH, RD, GN, WH/BK, BK
- 106 = 10x16 AWG OG, BU, WH/BK, RD/BK, GN/BK, OG/BK, RD, GN, BK, WH
- 126 = 12x16 AWG OG, BU, WH/BK, RD/BK, GN/BK, OG/BK, BU/BK, BK/WH, GN, RD, WH, BK

- \_\_A Metal Clad Cable (18 AWG straight only)
- \_\_D Smooth Plug Body (16 AWG straight only)

Cordset Part Number Key

Extension Examples:

Hybrid connector extensions also available. Consult factory.

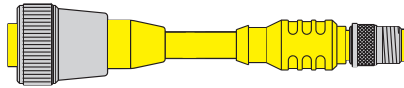

R K M 40 - 2M - R S C 4.4T

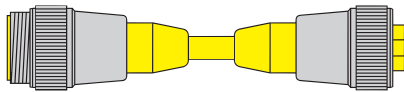

R S M R K M 30 - 4M /S..

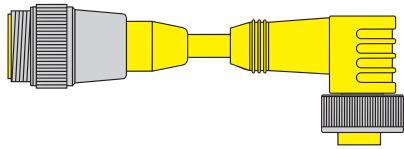

R S M W K M 30 - 4M /S..

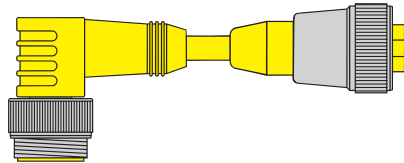

W S M R K M 30 - 4M /S..

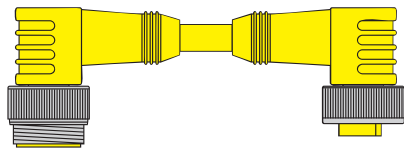

W S M W K M 30 - 4M /S..

**Receptacle Part Number key**

Part Number Keys are to assist in IDENTIFICATION ONLY. Consult factory for catalog items not identified.

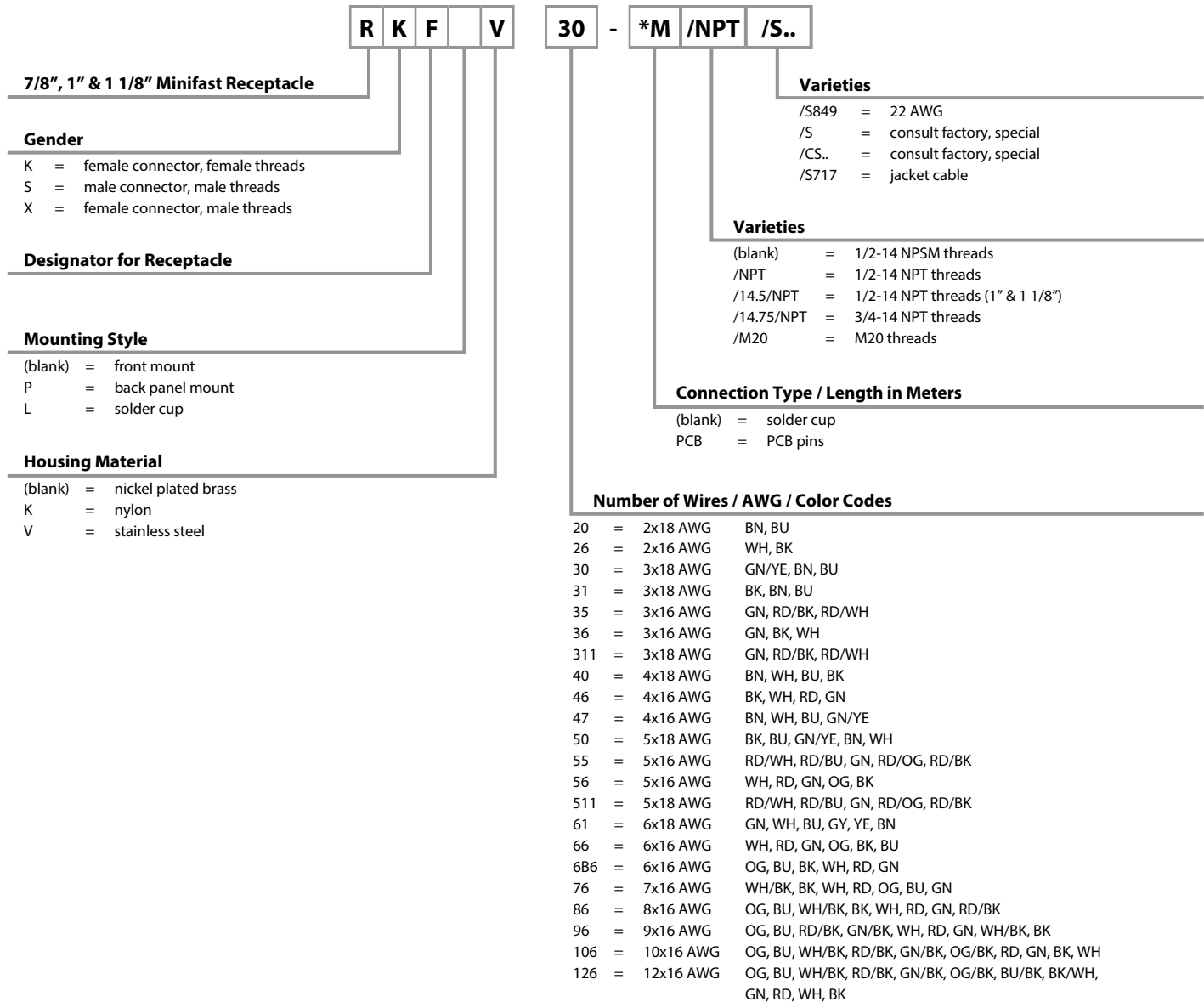

Field Wireable Part Number Key

Part Number Keys are to assist in IDENTIFICATION ONLY. Consult factory for catalog items not identified.

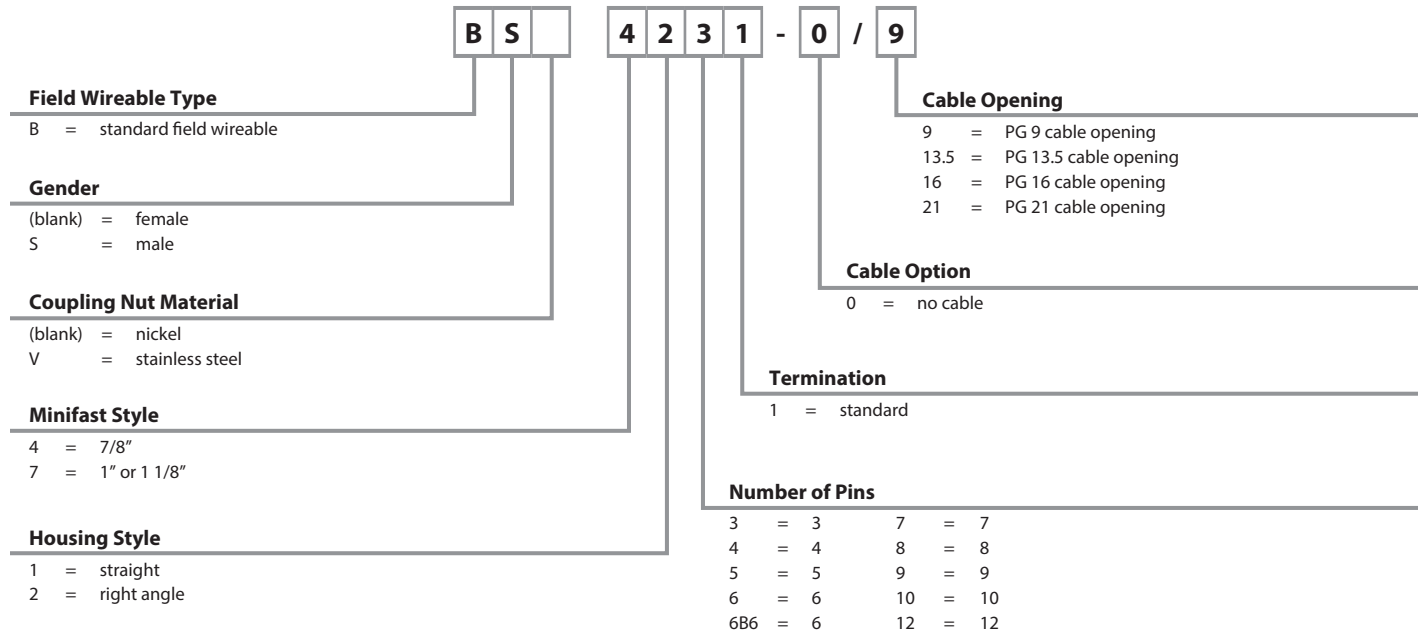

minifast®

- NEMA 1, 3, 4, 6P
- IEC IP67 Protection
- 9 A



| Connector Style  | Female Part Number   | Male Part Number   | Features  | Pinout                                 |
|--|--|--|---|--|
| <p><b>RKM ..**</b></p> <p><b>WKM ..**</b></p>              | <p><b>RKM 20- *M</b><br/><b>WKM 20- *M</b></p>             | <p><b>RSM 20- *M</b><br/><b>WSM 20- *M</b></p>             | <p>ITC/PLTC PVC Yellow<br/>2x18 AWG, 105 °C,<br/>6.2 mm OD, Cable<br/>#RF50511- *M, Flexlife®,<br/>600 V</p>  | <p>1. BN<br/>2. BU</p>                 |
| <p><b>RKM 30- *M</b><br/><b>WKM 30- *M</b></p>             | <p><b>RKM 30- *M</b><br/><b>WKM 30- *M</b></p>             | <p><b>RSM 30- *M</b><br/><b>WSM 30- *M</b></p>             | <p>ITC/PLTC PVC Yellow,<br/>3x18 AWG, 105 °C,<br/>6.2 mm OD, Cable<br/>#RF50880- *M, Flexlife,<br/>600 V</p>  | <p>1. GN/YE<br/>2. BN<br/>3. BU</p>    |
| <p><b>RSM ..**</b></p>                                     | <p><b>RKM 30- *M/S90</b><br/><b>WKM 30- *M/S90</b></p>     | <p><b>RSM 30- *M/S90</b><br/><b>WSM 30- *M/S90</b></p>     | <p>AWM TPU Yellow, 3x18<br/>AWG , 90 °C, 6.0 mm OD,<br/>Cable #RF50545- *M, Cut<br/>Abrasion Immune, 600 V</p>  | <p>1. GN/YE<br/>2. BN<br/>3. BU</p>    |
| <p><b>RKM 30- *M/S101</b><br/><b>WKM 30- *M/S101</b></p>   | <p><b>RKM 30- *M/S101</b><br/><b>WKM 30- *M/S101</b></p>   | <p><b>RSM 30- *M/S101</b><br/><b>WSM 30- *M/S101</b></p>   | <p>AWM TPE Yellow, 3x18<br/>AWG , 105 °C, 5.7 mm<br/>OD, Cable #RF51173- *M,<br/>Flexlife-20, high flex over<br/>20 million cycles, 600 V<br/>C-track</p> | <p>1. GN<br/>2. RD/BK<br/>3. RD/WH</p> |
| <p><b>RKM 311- *M</b><br/><b>WKM 311- *M</b></p>           | <p><b>RKM 311- *M</b><br/><b>WKM 311- *M</b></p>           | <p><b>RSM 311- *M</b><br/><b>WSM 311- *M</b></p>           | <p>ITC/PLTC PVC Yellow,<br/>3x18 AWG, 105 °C,<br/>6.2 mm OD, Cable<br/>#RF50520- *M, Flexlife,<br/>600 V</p>  | <p>1. GN<br/>2. RD/BK<br/>3. RD/WH</p> |
| <p><b>RKM 311- *M/S600</b><br/><b>WKM 311- *M/S600</b></p> | <p><b>RKM 311- *M/S600</b><br/><b>WKM 311- *M/S600</b></p> | <p><b>RSM 311- *M/S600</b><br/><b>WSM 311- *M/S600</b></p> | <p>SJOOW CPE, Yellow, 3x18<br/>AWG , 105 °C, 8.0 mm OD,<br/>Cable #RF50658- *M, Weld<br/>Flash Immune, Flame<br/>Immune, 300 V</p>                        | <p>1. GN<br/>2. RD/BK<br/>3. RD/WH</p> |

We reserve the right to make technical alterations without prior notice.

\* Length in meters. Standard cable lengths are 2, 4, 5, 6, 8 and 10 meters. Consult factory for other lengths.

\*\* Standard coupling nut material is nickel plated brass "RKM .."; "RK .." indicates nylon, "RKV .." indicates stainless steel, and "RKVH .." indicates stainless steel hex.



## 3-Wire Cordsets, Standard

- NEMA 1, 3, 4, 6P
- IEC IP67 Protection
- 9 A



| Connector Style        | Female Part Number                             | Male Part Number                               | Features  | Pinout   |
|------------------------|--|--|---|--|
| <p><b>RKM ..**</b></p> | <b>RKM 31-*M</b><br><b>WKM 31-*M</b>           | <b>RSM 31-*M</b><br><b>WSM 31-*M</b>           | ITC/PLTC PVC<br>Yellow, 3x18 AWG,<br>105 °C, 6.2 mm OD,<br>Cable #RF50513-*M,<br>Flexlife®, 600 V                       | <p style="text-align: center;"><b>Female</b></p> |
| <p><b>WKM ..**</b></p> |  |  |   |  |
| <p><b>RSM ..**</b></p> | <b>RKM 31-*M/S600</b><br><b>WKM 31-*M/S600</b> | <b>RSM 31-*M/S600</b><br><b>WSM 31-*M/S600</b> | SJOOW CPE Yellow,<br>3x18 AWG, 105 °C,<br>8.0 mm OD, Cable<br>#RF50654-*M, Weld<br>Flash Immune, Flame<br>Immune, 300 V | <p style="text-align: center;"><b>Male</b></p>   |
| <p><b>WSM ..**</b></p> |  |  |   |  |

We reserve the right to make technical alterations without prior notice.

\* Length in meters. Standard cable lengths are 2, 4, 5, 6, 8 and 10 meters. Consult factory for other lengths.

\*\* Standard coupling nut material is nickel plated brass "RKM .."; "RK .." indicates nylon, "RKM .." indicates stainless steel, and "RKVH .." indicates stainless steel hex.

Cordsets

- NEMA 1, 3, 4, 6P
- IEC IP67 Protection
- 9 A



| Connector Style        | Female Part Number                             | Male Part Number                               | Features  | Pinout               |  |
|------------------------|--|--|---|----------------------|--|
| <p><b>RKM ..**</b></p> | <b>RKM 40-*M</b><br><b>WKM 40-*M</b>           | <b>RSM 40-*M</b><br><b>WSM 40-*M</b>           | ITC/PLTC PVC Yellow, 4x18 AWG, 105 °C, 6.7 mm OD, Cable #RF50548-*M, Flexlife®, 600 V   | <p><b>Female</b></p> |  |
| <p><b>WKM ..**</b></p> | <b>RKM 40-*M/S90</b><br><b>WKM 40-*M/S90</b>   | <b>RSM 40-*M/S90</b><br><b>WSM 40-*M/S90</b>   | AWM TPU Yellow, 4x18 AWG, 90 °C, 7.2 mm OD, Cable #RF50544-*M, Cut/Abrasion Immune, 600 V                                       |                      |  |
| <p><b>RSM ..**</b></p> | <b>RKM 40-*M/S101</b><br><b>WKM 40-*M/S101</b> | <b>RSM 40-*M/S101</b><br><b>WSM 40-*M/S101</b> | AWM TPE Yellow, 4x18 AWG, 105 °C, 6.2 mm OD, Cable #RF50968-*M, Flexlife-20, High Flex - Over 20 million cycles, 600 V, C-track |                      | <p>1. BN<br/>2. WH<br/>3. BU<br/>4. BK</p> |
| <p><b>RSM ..**</b></p> | <b>RKM 40-*M/S529</b><br><b>WKM 40-*M/S529</b> | <b>RSM 40-*M/S529</b><br><b>WSM 40-*M/S529</b> | TPU Yellow, 4x20 AWG, 90 °C, 5.7 mm OD, Cable #RF50526-*M, Cut/Abrasion Immune, Braided Mechanical Shield, 300 V                |                      | <p><b>Male</b></p>                         |
| <p><b>WSM ..**</b></p> | <b>RKM 40-*M/S600</b><br><b>WKM 40-*M/S600</b> | <b>RSM 40-*M/S600</b><br><b>WSM 40-*M/S600</b> | SJOOW CPE Yellow, 4x18 AWG, 105 °C, 8.5 mm OD, Cable #RF50644-*M, Weld Flash Immune, Flame Immune, 300 V                        |                      |  |

We reserve the right to make technical alterations without prior notice.

\* Length in meters. Standard cable lengths are 2, 4, 5, 6, 8 and 10 meters. Consult factory for other lengths.

\*\* Standard coupling nut material is nickel plated brass "RKM .."; "RK .." indicates nylon, "RKM .." indicates stainless steel, and "RKVH .." indicates stainless steel hex.

## 5-Wire Cordsets, Standard

- NEMA 1, 3, 4, 6P
- IEC IP67 Protection
- 9 A



We reserve the right to make technical alterations without prior notice.

| Connector Style        | Female Part Number                               | Male Part Number                                 | Features  | Pinout                                       |
|------------------------|--|--|---|--|
| <p><b>RKM ..**</b></p> | <b>RKM 50-*M</b><br><b>WKM 50-*M</b>             | <b>RSM 50-*M</b><br><b>WSM 50-*M</b>             | ITC/PLTC PVC Yellow, 5x18 AWG, 105 °C, 7.6 mm OD, Cable #RF50549-*M, Flexlife®, 600 V   |  |
|                        | <b>RKM 50-*M/S90</b><br><b>WKM 50-*M/S90</b>     | <b>RSM 50-*M/S90</b><br><b>WSM 50-*M/S90</b>     | AWM TPU Yellow, 5x18 AWG, 90 °C, 7.2 mm OD, Cable #RF50751-*M, Cut/Abrasion Immune, 600 V                                     | 1. BK<br>2. BU<br>3. GN/YE<br>4. BN<br>5. WH |
| <p><b>WKM ..**</b></p> | <b>RKM 50-*M/S101</b><br><b>WKM 50-*M/S101</b>   | <b>RSM 50-*M/S101</b><br><b>WSM 50-*M/S101</b>   | AWM TPE Yellow, 5x18 AWG, 105 °C, 6.7 mm OD, Cable #RF51174-*M, Flexlife-20, high flex over 20 million cycles, 600 V, C-track |  |
| <p><b>RSM ..**</b></p> | <b>RKM 50-*M/S1551</b><br><b>WKM 50-*M/S1551</b> | <b>RSM 50-*M/S1551</b><br><b>WSM 50-*M/S1551</b> | ITC/PLTC PVC Yellow, 5x18 AWG, 105 °C, 7.6 mm OD, Cable #RF50578-*M, Yellow conductor instead of Green/Yellow, 600 V          | 1. BK<br>2. BU<br>3. YE<br>4. BN<br>5. WH    |
|                        | <b>RKM 511-*M</b><br><b>WKM 511-*M</b>           | <b>RSM 511-*M</b><br><b>WSM 511-*M</b>           | ITC/PLTC PVC Yellow, 5x18 AWG, 105 °C, 7.6 mm OD, Cable #RF50521-*M, Flexlife, 600 V  |  |
| <p><b>WSM ..**</b></p> | <b>RKM 511-*M/S600</b><br><b>WKM 511-*M/S600</b> | <b>RSM 511-*M/S600</b><br><b>WSM 511-*M/S600</b> | SJOOW CPE Yellow, 5x18 AWG, 105 °C, 9.4 mm OD, Cable #RF50659-*M, Weld Flash Immune, Flame Immune, 300 V                      |  |

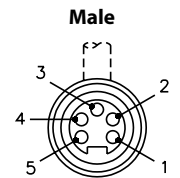
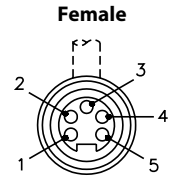

Cordsets

\* Length in meters. Standard cable lengths are 2, 4, 5, 6, 8 and 10 meters. Consult factory for other lengths.

\*\* Standard coupling nut material is nickel plated brass "RKM .."; "RK .." indicates nylon, "RKV .." indicates stainless steel, and "RKVH .." indicates stainless steel hex.

## 6-Wire Cordsets, Standard

- NEMA 1, 3, 4, 6P
- IEC IP67 Protection
- 8 A



| Connector Style        | Female Part Number                             | Male Part Number                               | Features  | Pinout  |
|------------------------|--|--|---|---|
| <p><b>RKM ..**</b></p> | <b>RKM 61-*M</b><br><b>WKM 61-*M</b>           | <b>RSM 61-*M</b><br><b>WSM 61-*M</b>           | ITC/PLTC PVC Yellow, 6x18 AWG, 105 °C, 8.4 mm OD, Cable #RF50575-*M, Flexlife®, 600 V   | <p>1. BN<br/>2. N/C<br/>3. GN/YE<br/>4. N/C<br/>5. BU<br/>6. N/C</p> <p style="text-align: center;"><b>Female</b></p> |
| <p><b>WKM ..**</b></p> | <b>RKM 61-*M/S739</b><br><b>WKM 61-*M/S739</b> | <b>RSM 61-*M/S739</b><br><b>WSM 61-*M/S739</b> | ITC/PLTC PVC Yellow, 7x18 AWG, 105 °C, 8.4 mm OD, Cable #RF50637-*M, Shielded cable with drain wire, not connected at plug, 600 V | <p>1. GN<br/>2. WH<br/>3. BU<br/>4. Gy<br/>5. YE<br/>6. BN</p>  |
| <p><b>RSM ..**</b></p> |  |  |   |   |
| <p><b>WSM ..**</b></p> | <b>RKM 61-*M/S763</b><br><b>WKM 61-*M/S763</b> | <b>RSM 61-*M/S763</b><br><b>WSM 61-*M/S763</b> | ITC/PLTC PVC Black, 6x18 AWG, 105 °C, 8.4 mm OD, Cable #RF50551-*M, Shielded cable with drain wire, not connected at plug, 600 V  | <p>1. BU<br/>2. WH<br/>3. BK<br/>4. GN<br/>5. RD<br/>6. OG</p> <p style="text-align: center;"><b>Male</b></p>         |

We reserve the right to make technical alterations without prior notice.

\* Length in meters. Standard cable lengths are 2, 4, 5, 6, 8 and 10 meters. Consult factory for other lengths.

\*\* Standard coupling nut material is nickel plated brass "RKM .."; "RK .." indicates nylon, "RKM .." indicates stainless steel, and "RKVH .." indicates stainless steel hex.

## 2 and 3-Wire Cordsets, Heavy Duty

- NEMA 1, 3, 4, 6P
- IEC IP67 Protection
- 600 V, 10 A



We reserve the right to make technical alterations without prior notice.

| Connector Style        | Female Part Number                               | Male Part Number                                 | Features   | Pinout                                  |
|------------------------|--|--|--|---|
| <p><b>RKM ..**</b></p> | <b>RKM 26-*M</b><br><b>WKM 26-*M</b>             | <b>RSM 26-*M</b><br><b>WSM 26-*M</b>             | STOOW PVC Yellow 2x16 AWG, 105 °C, 9.6 mm OD, Cable #RF50561-*M, Flexlife®                           | <p><b>Female</b></p> <p><b>Male</b></p> |
| <p><b>WKM ..**</b></p> | <b>RKM 35-*M</b><br><b>WKM 35-*M</b>             | <b>RSM 35-*M</b><br><b>WSM 35-*M</b>             | STOOW PVC Yellow, 3x16 AWG, 105 °C, 10.0 mm OD, Cable #RF50537-*M, Flexlife                          | <p><b>Female</b></p>                    |
| <p><b>RSM ..**</b></p> | <b>RKM 35-*M/S600</b><br><b>WKM 35-*M/S600</b>   | <b>RSM 35-*M/S600</b><br><b>WSM 35-*M/S600</b>   | SOOW CPE Yellow, 3x16 AWG, 105 °C, 10.3 mm OD, Cable #RF50596-*M, Weld Flash Immune, Flame Immune    | <p><b>Female</b></p>                    |
| <p><b>WSM ..**</b></p> | <b>RKM 36-*M</b><br><b>WKM 36-*M</b>             | <b>RSM 36-*M</b><br><b>WSM 36-*M</b>             | STOOW PVC Yellow, 3x16 AWG, 105 °C, 10.0 mm OD, Cable #RF50536-*M, Flexlife                          | <p><b>Male</b></p>                      |
| <p><b>WSM ..**</b></p> | <b>RKM 36-*M/S1587</b><br><b>WKM 36-*M/S1587</b> | <b>RSM 36-*M/S1587</b><br><b>WSM 36-*M/S1587</b> | SEOOW/STOOW TPE Yellow, 3x16 AWG, 105 °C, 10.0 mm OD, Cable #RF51563-*M, Weldlife, Weld Flash Immune | <p><b>Male</b></p>                      |

\* Length in meters. Standard cable lengths are 2, 4, 5, 6, 8 and 10 meters. Consult factory for other lengths.

\*\* Standard coupling nut material is nickel plated brass "RKM .."; "RK .." indicates nylon, "RKV .." indicates stainless steel, and "RKVH .." indicates stainless steel hex.

Cordsets

## 4-Wire Cordsets, Heavy Duty

- NEMA 1, 3, 4, 6P
- IEC IP67 Protection
- 600 V, 10 A



| Connector Style        | Female Part Number                             | Male Part Number                               | Features  | Pinout  |
|------------------------|--|--|---|---|
| <p><b>RKM ..**</b></p> | <b>RKM 46-*M</b><br><b>WKM 46-*M</b>           | <b>RSM 46-*M</b><br><b>WSM 46-*M</b>           | STOOW PVC Yellow, 4x16 AWG, 105 °C, 10.8 mm OD, Cable #RF50538-*M, Flexlife®                    | <p><b>Female</b></p>  |
| <p><b>WKM ..**</b></p> | <b>RKM 46-*M/S600</b><br><b>WKM 46-*M/S600</b> | <b>RSM 46-*M/S600</b><br><b>WSM 46-*M/S600</b> | SOOW CPE Yellow, 4x16 AWG, 105 °C, 11 mm OD, Cable #RF50595-*M, Weld Flash Immune, Flame Immune | <p>1. BK<br/>2. WH<br/>3. RD<br/>4. GN</p>  |
| <p><b>RSM ..**</b></p> | <b>RKM 46-*M/S824</b><br><b>WKM 46-*M/S824</b> | <b>RSM 46-*M/S824</b><br><b>WSM 46-*M/S824</b> | TC PVC Yellow, 4x16 AWG, 90 °C, 9.2 mm OD, Cable #RF51220-*M, Tray Rated                        | <p><b>Male</b></p>  |
| <p><b>WSM ..**</b></p> | <b>RKM 47-*M</b><br><b>WKM 47-*M</b>           | <b>RSM 47-*M</b><br><b>WSM 47-*M</b>           | STOOW PVC Yellow, 4x16 AWG, 105 °C, 10.8 mm OD, Cable #RF50626-*M, Flexlife                     | <p>1. BN<br/>2. WH<br/>3. BU<br/>4. GN/YE</p> <p><b>Female</b></p> <p><b>Male</b></p> |

We reserve the right to make technical alterations without prior notice.

\* Length in meters. Standard cable lengths are 2, 4, 5, 6, 8 and 10 meters. Consult factory for other lengths.

\*\* Standard coupling nut material is nickel plated brass "RKM .."; "RK .." indicates nylon, "RKV .." indicates stainless steel, and "RKVH .." indicates stainless steel hex.

## 5 and 6-Wire Cordsets, Heavy Duty

- NEMA 1, 3, 4, 6P
- IEC IP67 Protection
- 600 V, 10 A (5-pin), 8 A (6-pin)



We reserve the right to make technical alterations without prior notice.

| Connector Style        | Female Part Number                               | Male Part Number                                 | Features  | Pinout  |
|------------------------|--|--|---|---|
| <p><b>RKM ..**</b></p> | <b>RKM 55-*M</b><br><b>WKM 55-*M</b>             | <b>RSM 55-*M</b><br><b>WSM 55-*M</b>             | STOOW PVC Yellow, 5x16 AWG, 105 °C, 12.7 mm OD, Cable #RF50540-*M, Flexlife®                        | 1. RD/WH<br>2. RD/BU<br>3. GN<br>4. RD/OG<br>5. RD/BK |
|                        | <b>RKM 55-*M/S600</b><br><b>WKM 55-*M/S600</b>   | <b>RSM 55-*M/S600</b><br><b>WSM 55-*M/S600</b>   | SOOW CPE Yellow, 5x16 AWG, 105 °C, 13 mm OD, Cable #RF50597-*M, Weld Flash Immune, Flame Immune     | 1. RD<br>2. RD<br>3. GN<br>4. RD<br>5. RD             |
| <p><b>WKM ..**</b></p> | <b>RKM 56-*M</b><br><b>WKM 56-*M</b>             | <b>RSM 56-*M</b><br><b>WSM 56-*M</b>             | STOOW PVC Yellow, 5x16 AWG, 105 °C, 12.7 mm OD, Cable #RF50539-*M, Flexlife                         | 1. WH<br>2. RD<br>3. GN<br>4. OG<br>5. BK             |
|                        | <b>RKM 56-*M/S1587</b><br><b>WKM 56-*M/S1587</b> | <b>RSM 56-*M/S1587</b><br><b>WSM 56-*M/S1587</b> | SEOOW/STOOW TPE Yellow, 5x16 AWG, 105 °C, 12.7 mm OD Cable #RF51265-*M, Weldlife, Weld Flash Immune |   |
| <p><b>RSM ..**</b></p> | <b>RKM 66-*M</b><br><b>WKM 66-*M</b>             | <b>RSM 66-*M</b><br><b>WSM 66-*M</b>             | STOOW PVC Yellow, 6x16 AWG, 105 °C, 13.6 mm OD Cable #RF50565-*M,                                   | 1. WH<br>2. RD<br>3. GN<br>4. OG<br>5. BK<br>6. BU    |
|                        | <b>RKM 66-*M/S1587</b><br><b>WKM 66-*M/S1587</b> | <b>RSM 66-*M/S1587</b><br><b>WSM 66-*M/S1587</b> | SEOOW TPE Yellow, 6x16 AWG, 105 °C, 13.6 mm OD, Cable #RF51564-*M, Weldlife, Weld Flash Immune      |   |
| <p><b>WSM ..**</b></p> |  |  |   |   |

Cordsets

\* Length in meters. Standard cable lengths are 2, 4, 5, 6, 8 and 10 meters. Consult factory for other lengths.  
 \*\* Standard coupling nut material is nickel plated brass "RKM .."; "RK .." indicates nylon, "RKV .." indicates stainless steel, and "RKH .." indicates stainless steel hex.

- NEMA 1, 3, 4, 6P
- IEC IP68 Protection
- 600 V, 8 A



| Connector Style        | Female Part Number                               | Male Part Number                                 | Features   | Pinout   |
|------------------------|--|--|--|--|
| <p><b>RKM ..**</b></p> | <b>RKM 6B6-*M</b><br><b>WKM 6B6-*M</b>           | <b>RSM 6B6-*M</b><br><b>WSM 6B6-*M</b>           | ITC/PLTC PVC Yellow, 6x16 AWG, 105 °C, 9.0 mm OD, Cable #RF51030-*M, Flexlife®   | <p><b>Female</b></p> <p><b>Male</b></p>                        |
|                        | <b>RKM 6B6-*M/S90</b><br><b>WKM 6B6-*M/S90</b>   | <b>RSM 6B6-*M/S90</b><br><b>WSM 6B6-*M/S90</b>   | AWM TPU Yellow, 6x16 AWG, 90 °C, 9.0 mm OD, Cable #RF51137-*M, Cut/abrasion Immune                                       |  |
| <p><b>WKM ..**</b></p> | <b>RKM 6B6-*M/S101</b><br><b>WKM 6B6-*M/S101</b> | <b>RSM 6B6-*M/S101</b><br><b>WSM 6B6-*M/S101</b> | AWM TPE Yellow, 6x16 AWG, 105 °C, 8.5 mm OD, Cable #RF51044-*M, Flexlife-20, High flex - over 20 million cycles, C-track | <p>1. OG<br/>2. BU<br/>3. BK<br/>4. WH<br/>5. RD<br/>6. GN</p> |
|                        | <b>RKM 76-*M</b><br><b>WKM 76-*M</b>             | <b>RSM 76-*M</b><br><b>WSM 76-*M</b>             | ITC/PLTC PVC Yellow, 7x16 AWG, 105 °C, 9.6 mm OD, Cable #RF51031-*M, Flexlife  |  |
| <p><b>RSM ..**</b></p> | <b>RKM 76-*M/S90</b><br><b>WKM 76-*M/S90</b>     | <b>RSM 76-*M/S90</b><br><b>WSM 76-*M/S90</b>     | AWM TPU Yellow, 7x16 AWG, 90 °C, 9.0 mm OD, Cable #RF51138-*M, Cut/abrasion Immune                                       |  |
|                        | <b>RKM 76-*M/S101</b><br><b>WKM 76-*M/S101</b>   | <b>RSM 76-*M/S101</b><br><b>WSM 76-*M/S101</b>   | AWM TPE Yellow, 7x16 AWG, 105 °C, 9.6 mm OD, Cable #RF51049-*M, Flexlife-20, High flex - over 20 million cycles, C-track |  |
| <p><b>WSM ..**</b></p> | <b>RKM 76-*M/S1587</b><br><b>WKM 76-*M/S1587</b> | <b>RSM 76-*M/S1587</b><br><b>WSM 76-*M/S1587</b> | ITC/PLTC TPE Yellow, 7x16 AWG, 105 °C, 9.6 mm OD, Cable #RF51009-*M, Weldlife, Weld Flash Immune                         |  |
|                        |  |  |  |  |

We reserve the right to make technical alterations without prior notice.

\* Length in meters. Standard cable lengths are 2, 4, 5, 6, 8 and 10 meters. Consult factory for other lengths.

\*\* Standard coupling nut material is nickel plated brass "RKM .."; "RKMV .." indicates stainless steel.



## 8-Wire Cordsets, B-Size Heavy Duty

- NEMA 1, 3, 4, 6P
- IEC IP68 Protection
- 600 V, 8 A



| Connector Style        | Female Part Number                               | Male Part Number                                 | Features   | Pinout                                  |
|------------------------|--|--|--|---|
| <p><b>RKM ..**</b></p> | <b>RKM 86-*M</b><br><b>WKM 86-*M</b>             | <b>RSM 86-*M</b><br><b>WSM 86-*M</b>             | ITC PLTC PVC Yellow, 8x16 AWG, 105 °C, 10.0 mm OD, Cable #RF51032-*M, Flexlife®                                      | <p><b>Female</b></p> <p><b>Male</b></p> |
| <p><b>WKM ..**</b></p> | <b>RKM 86-*M/S90</b><br><b>WKM 86-*M/S90</b>     | <b>RSM 86-*M/S90</b><br><b>WSM 86-*M/S90</b>     | AWM TPU Yellow, 8x16 AWG, 90 °C, 10.0 mm OD, Cable #RF51139-*M, Cut/abrasion Immune                                  |   |
| <p><b>RSM ..**</b></p> | <b>RKM 86-*M/S101</b><br><b>WKM 86-*M/S101</b>   | <b>RSM 86-*M/S101</b><br><b>WSM 86-*M/S101</b>   | AWM TPE Yellow, 8x16, 105 °C, 10.5 mm OD, Cable #RF51050-*M, Flexlife-20, High flex - over 20 million cycles C-track |   |
| <p><b>WSM ..**</b></p> | <b>RKM 86-*M/S1587</b><br><b>WKM 86-*M/S1587</b> | <b>RSM 86-*M/S1587</b><br><b>WSM 86-*M/S1587</b> | ITC/PLTC TPE Yellow, 8x16 AWG, 105 °C, 10.0 mm OD, Cable #RF51011-*M, Weldlife, Weld Flash Immune                    |   |

We reserve the right to make technical alterations without prior notice.

Cordsets

\* Length in meters. Standard cable lengths are 2, 4, 5, 6, 8 and 10 meters. Consult factory for other lengths.

\*\* Standard coupling nut material is nickel plated brass "RKM .."; "RKV .." indicates stainless steel.

# 1 1/8" minifast® Connectivity Products

## 9 and 10-Wire Cordsets, C-Size Heavy Duty



- NEMA 1, 3, 4, 6P
- IEC IP68 Protection
- 600 V, 7 A



| Connector Style        | Female Part Number                                 | Male Part Number                                   | Features   | Pinout               |
|------------------------|--|--|--|----------------------|
| <p><b>RKM ..**</b></p> | <b>RKM 96-*M</b><br><b>WKM 96-*M</b>               | <b>RSM 96-*M</b><br><b>WSM 96-*M</b>               | ITC/PLTC PVC Yellow, 9x16 AWG, 105 °C, 11.3 mm OD, Cable #RF51033-*M, Flexlife®  | <p><b>Female</b></p> |
|                        | <b>RKM 96-*M/S90</b><br><b>WKM 96-*M/S90</b>       | <b>RSM 96-*M/S90</b><br><b>WSM 96-*M/S90</b>       | AWM TPU Yellow, 9x16 AWG, 90 °C, 10.5 mm OD, Cable #RF51140-*M, Cut/abrasion Immune  |                      |
| <p><b>WKM ..**</b></p> | <b>RKM 96-*M/S101</b><br><b>WKM 96-*M/S101</b>     | <b>RSM 96-*M/S101</b><br><b>WSM 96-*M/S101</b>     | AWM TPE Yellow, 12x16 AWG, 105 °C, 13.7 mm OD, Cable #RF51148-*M, Flexlife-20, High flex - over 20 million cycles, C-track | <p><b>Male</b></p>   |
|                        | <b>RKM 96-*M/S1587</b><br><b>WKM 96-*M/S1587</b>   | <b>RSM 96-*M/S1587</b><br><b>WSM 96-*M/S1587</b>   | ITC/PLTC TPE Yellow, 9x16 AWG, 105 °C, 11.2 mm OD, Cable #RF51013-*M, Weldlife, Weld Flash Immune                          |                      |
| <p><b>RSM ..**</b></p> | <b>RKM 106-*M</b><br><b>WKM 106-*M</b>             | <b>RSM 106-*M</b><br><b>WSM 106-*M</b>             | ITC/PLTC PVC Yellow, 10x16 AWG, 105 °C, 12.0 mm OD, Cable #RF51034-*M, Flexlife  | <p><b>Female</b></p> |
|                        | <b>RKM 106-*M/S90</b><br><b>WKM 106-*M/S90</b>     | <b>RSM 106-*M/S90</b><br><b>WSM 106-*M/S90</b>     | AWM TPU Yellow, 10x16 AWG, 90 °C, 12.0 mm OD, Cable #RF51141-*M, Cut/abrasion Immune                                       |                      |
| <p><b>WSM ..**</b></p> | <b>RKM 106-*M/S101</b><br><b>WKM 106-*M/S101</b>   | <b>RSM 106-*M/S101</b><br><b>WSM 106-*M/S101</b>   | AWM TPE Yellow, 12x16 AWG, 105 °C, 13.7 mm OD, Cable #RF51148-*M, Flexlife-20, High flex - over 20 million cycles, C-track | <p><b>Male</b></p>   |
|                        | <b>RKM 106-*M/S1587</b><br><b>WKM 106-*M/S1587</b> | <b>RSM 106-*M/S1587</b><br><b>WSM 106-*M/S1587</b> | ITC/PLTC TPE Yellow, 10x16 AWG, 105 °C, 12.0 mm OD, Cable #RF51015-*M Weldlife, Weld Flash Immune                          |                      |

We reserve the right to make technical alterations without prior notice.

\* Length in meters. Standard cable lengths are 2, 4, 5, 6, 8 and 10 meters. Consult factory for other lengths.

\*\* Standard coupling nut material is nickel plated brass "RKM .."; "RKV .." indicates stainless steel.

## 8-Wire Cordsets, B-Size Heavy Duty

- NEMA 1, 3, 4, 6P
- IEC IP68 Protection
- 250 V, 4 A



We reserve the right to make technical alterations without prior notice.

| Connector Style        | Female Part Number                                 | Male Part Number                                   | Features   | Pinout  |
|------------------------|--|--|--|---|
| <p><b>RKM ..**</b></p> | <b>RKM 126-*M</b><br><b>WKM 126-*M</b>             | <b>RSM 126-*M</b><br><b>WSM 126-*M</b>             | ITC/PLTC PVC Yellow, 12x16 AWG, 105 °C, 12.5 mm OD, Cable #RF51035-*M, Flexlife®   | <p><b>Female</b></p> <p>1. OG<br/>2. BU<br/>3. WH/BK<br/>4. RD/BK<br/>5. GN/BK<br/>6. OG/BK<br/>7. BU/BK<br/>8. BK/WH<br/>9. GN<br/>10. RD<br/>11. WH<br/>12. BK</p> <p><b>Male</b></p> |
| <p><b>WKM ..**</b></p> | <b>RKM 126-*M/S90</b><br><b>WKM 126-*M/S90</b>     | <b>RSM 126-*M/S90</b><br><b>WSM 126-*M/S90</b>     | AWM TPU Yellow, 12x16 AWG, 90 °C, 12.4 mm OD, Cable #RF51142-*M, Cut/abrasion Immune                                       |   |
| <p><b>RSM ..**</b></p> | <b>RKM 126-*M/S101</b><br><b>WKM 126-*M/S101</b>   | <b>RSM 126-*M/S101</b><br><b>WSM 126-*M/S101</b>   | AWM TPE Yellow, 12x16 AWG, 105 °C, 13.7 mm OD, Cable #RF51148-*M, Flexlife-20, High flex - over 20 million cycles, C-track |   |
| <p><b>WSM ..**</b></p> | <b>RKM 126-*M/S1587</b><br><b>WKM 126-*M/S1587</b> | <b>RSM 126-*M/S1587</b><br><b>WSM 126-*M/S1587</b> | ITC/PLTC TPE Yellow, 12x16 AWG, 105 °C, 12.5 mm OD, Cable #RF51017-*M, Weldlife, Weld Flash Immune                         |   |

\* Length in meters. Standard cable lengths are 2, 4, 5, 6, 8 and 10 meters. Consult factory for other lengths.  
 \*\* Standard coupling nut material is nickel plated brass "RKM .."; "RKM .." indicates stainless steel.

Cordsets

# 1 1/8" minifast® Connectivity Products

## 19-Wire Cordsets, C-Size Heavy Duty



- NEMA 1, 3, 4, 6P
- IEC IP68 Protection



| Connector Style        | Female Part Number                               | Male Part Number                                 | Features   | Pinout                                  |
|------------------------|--|--|--|---|
| <p><b>RKM ..**</b></p> | <b>RKM 190-*M</b><br><b>WKM 190-*M</b>           | <b>RSM 190-*M</b><br><b>WSM 190-*M</b>           | ITC/PLTC PVC Yellow, 3x18, 16x22 AWG, 105 °C, 300 VAC/VDC, 4 A (pins 5, 7, & 12), 2 A (all other pins), 10.0 mm OD, Cable #RF50620-*M, Flexlife®   | <p><b>Female</b></p> <p><b>Male</b></p> |
| <p><b>WKM ..**</b></p> | <b>RKM 190-*M/S90</b><br><b>WKM 190-*M/S90</b>   | <b>RSM 190-*M/S90</b><br><b>WSM 190-*M/S90</b>   | AWM TPU Yellow, 3x18, 16x22 AWG, 90 °C, 300 VAC/VDC, 4 A (pins 5, 7, & 12), 2 A (all other pins), 10.0 mm OD, Cable #RF50682-*M, Cut/abrasion Immune                                       |   |
| <p><b>RSM ..**</b></p> | <b>RKM 190-*M/S101</b><br><b>WKM 190-*M/S101</b> | <b>RSM 190-*M/S101</b><br><b>WSM 190-*M/S101</b> | AWM TPE Yellow, 3x18, 16x22 AWG, 105 °C, 300 VAC/VDC, 4 A (pins 5, 7, & 12), 2 A (all other pins), 11.2 mm OD, Cable #RF50916-*M, Flexlife-20, High flex - over 20 million cycles, C-track |   |
| <p><b>WSM ..**</b></p> | <b>RKM 190-*M/S760</b><br><b>WKM 190-*M/S760</b> | <b>RSM 190-*M/S760</b><br><b>WSM 190-*M/S760</b> | ITC/PLTC PVC Black, 3x18, 16x22 AWG, 105 °C, 300 VAC/VDC, 4 A (pins 5, 7, & 12), 2 A (all other pins), 10.0 mm OD, Cable #RF50733-*M, Flexlife   |   |

We reserve the right to make technical alterations without prior notice.

\* Length in meters. Standard cable lengths are 2, 4, 5, 6, 8 and 10 meters. Consult factory for other lengths.

\*\* Standard coupling nut material is nickel plated brass "RKM .."; "RKV .." indicates stainless steel.

2-6 Wire Extreme Duty, Armored Cordsets

- NEMA 1, 3, 4, 6P
- IEC IP67 Protection
- 300 V, 9 A (2-5-pin), 8 A (6-pin)



| Connector Style  | Female Part Number | Male Part Number | Features  | Pinout   |
|------------------|--------------------|------------------|---|--|
| <p>RKM ..A**</p> | RKM 28A-*M         | RSM 28A-*M       | MC ITC/PLTC PVC Armor Yellow, 2x18 AWG, 105 °C, 14.4 mm OD, Cable #RF51039-*M, Armor Cable for Extreme Conditions, CSA Approved ITCERDB | <p>1. WH<br/>2. BK</p>   |
|                  | RKM 38A-*M         | RSM 38A-*M       | MC ITC/PLTC PVC Armor Yellow, 3x18 AWG, 105 °C, 14.9 mm OD, Cable #RF51040-*M, Armor Cable for Extreme Conditions, CSA Approved ITCERDB | <p>1. GN<br/>2. BK<br/>3. WH</p>                               |
|                  | RKM 48A-*M         | RSM 48A-*M       | MC ITC/PLTC PVC Armor Yellow, 4x18 AWG, 105 °C, 15.2 mm OD, Cable #RF51041-*M, Armor Cable for Extreme Conditions, CSA Approved ITCERDB | <p>1. BK<br/>2. WH<br/>3. RD<br/>4. GN</p>                     |
|                  | RKM 58A-*M         | RSM 58A-*M       | MC PVC Armor Yellow, 5x18 AWG, 90 °C, 14.9 mm OD, Cable #RF51042-*M, Armor Cable for Extreme Conditions ITCERDB                         | <p>1. WH<br/>2. RD<br/>3. GN<br/>4. OG<br/>5. BK</p>           |
|                  | RKM 68A-*M         | RSM 68A-*M       | MC PVC Armor Yellow, 6x18 AWG, 90 °C, 14.9 mm OD, Cable #RF51043-*M, Armor Cable for Extreme Conditions ITCERDB                         | <p>1. WH<br/>2. RD<br/>3. GN<br/>4. OG<br/>5. BK<br/>6. BU</p> |
| <p>RSM ..A**</p> |                    |                  |   |  |

We reserve the right to make technical alterations without prior notice.

Cordsets

\* Length in meters. Standard cable lengths are 2, 4, 5, 6, 8 and 10 meters. Consult factory for other lengths.  
 \*\* Standard coupling nut material is nickel plated brass "RKM .."; "RKV .." indicates stainless steel.

- NEMA 1, 3, 4, 6P
- IEC IP67 Protection
- 600 V, 9 A



| Connector Style         | Female Part Number | Male Part Number  | Features  | Pinout                                  |
|-------------------------|--------------------|-------------------|---|---|
| <p><b>RKM ..D**</b></p> | <b>RKM 26D-*M</b>  | <b>RSM 26D-*M</b> | STOOW PVC Yellow 2x16 AWG, 105 °C, 9.6 mm OD, Cable #RF50561-*M, Flexlife®  | <p><b>Female/Male</b></p>               |
|                         | <b>RKM 35D-*M</b>  | <b>RSM 35D-*M</b> | STOOW PVC Yellow, 3x16 AWG, 105 °C, 10.0 mm OD, Cable #RF50537-*M, Flexlife | <p><b>Female</b></p>                    |
|                         | <b>RKM 36D-*M</b>  | <b>RSM 36D-*M</b> | STOOW PVC Yellow, 3x16 AWG, 105 °C, 10.0 mm OD, Cable #RF50536-*M, Flexlife | <p><b>Male</b></p>                      |
|                         | <b>RKM 46D-*M</b>  | <b>RSM 46D-*M</b> | STOOW PVC Yellow, 4x16 AWG, 105 °C, 10.8 mm OD, Cable #RF50538-*M, Flexlife | <p><b>Female</b></p> <p><b>Male</b></p> |
|                         | <b>RKM 56D-*M</b>  | <b>RSM 56D-*M</b> | STOOW PVC Yellow, 5x16 AWG, 105 °C, 12.7 mm OD, Cable #RF50539-*M, Flexlife | <p><b>Female</b></p> <p><b>Male</b></p> |
| <p><b>RSM ..D**</b></p> |                    |                   |   |   |

We reserve the right to make technical alterations without prior notice.

\* Length in meters. Standard cable lengths are 2, 4, 5, 6, 8 and 10 meters. Consult factory for other lengths.

\*\* Standard coupling nut material is nickel plated brass "RKM .."; "RKV .." indicates stainless steel.

3 and 5-Wire Spiral Cordsets, Standard

- NEMA 1, 3, 4, 6P
- IEC IP67 Protection
- 300 V, 9 A



We reserve the right to make technical alterations without prior notice.

| Connector Style        | Female Part Number   | Male Part Number   | Features  | Pinout               |
|------------------------|--|--|---|----------------------|
| <p><b>RKM ..**</b></p> | <p><b>RKM 30-2M/S90-SP</b><br/><b>WKM 30-2M/S90-SP</b></p> | <p><b>RSM 30-2M/S90-SP</b><br/><b>WSM 30-2M/S90-SP</b></p> | <p>AWM TPU Yellow 3x18 AWG, 90 °C, 300 V, 9 A, 7.2 mm OD, for repetitive 2-wire AC with ground or 3-wire applications</p> | <p><b>Female</b></p> |
| <p><b>WKM ..**</b></p> |  |  |   | <p><b>Male</b></p>   |
| <p><b>RSM ..**</b></p> | <p><b>RKM 50-1M/S90-SP</b><br/><b>WKM 50-1M/S90-SP</b></p> | <p><b>RSM 50-1M/S90-SP</b><br/><b>WSM 50-1M/S90-SP</b></p> | <p>AWM TPU Yellow 5x18 AWG, 90 °C, 300 V, 9 A, 7.2 mm OD, for repetitive 5-wire AC applications</p>                       | <p><b>Female</b></p> |
| <p><b>WSM ..**</b></p> |  |  |   | <p><b>Male</b></p>   |

Standard cable lengths are 2 (3-wire) and 1 (5-wire) meters. Consult factory for other lengths.  
 \*\* Standard coupling nut material is nickel plated brass "RKM .."; "RKV .." indicates stainless steel.

Cordsets

- NEMA 1, 3, 4, 6P
- IEC IP67 Protection
- Polypropylene Contact Holder, Mold Material and Cable Jacket
- High Chemical Solvent Resistance & Tensile Strength



| Connector Style           | Female Part Number                         | Male Part Number                           | Features  | Pinout  |
|---------------------------|--|--|---|---|
| <p><b>WD-RKV ..**</b></p> | <b>WD-RKV 20-*M</b><br><b>WD-WKV 20-*M</b> | <b>WD-RSV 20-*M</b><br><b>WD-WSV 20-*M</b> | PP White, 2x18 AWG, 105 °C, 300 V, 9 A, 5.1 mm OD, Cable #RF51441-*M  | <b>Female</b><br>1. BN<br>2. BU<br>                   |
|                           | <b>WD-RKV 26-*M</b><br><b>WD-WKV 26-*M</b> | <b>WD-RSV 26-*M</b><br><b>WD-WSV 26-*M</b> | PP White, 2x16 AWG, 105 °C, 600 V, 10 A, 6.2 mm OD, Cable #RF51442-*M | <b>Female</b><br>1. WH<br>2. BK<br>                   |
| <p><b>WD-WKV ..**</b></p> | <b>WD-RKV 30-*M</b><br><b>WD-WKV 30-*M</b> | <b>WD-RSV 30-*M</b><br><b>WD-WSV 30-*M</b> | PP White, 3x18 AWG, 105 °C, 300 V, 9 A, 5.7 mm OD, Cable #RF51443-*M  | <b>Female</b><br>1. GN/YE<br>2. BN<br>3. BU<br>       |
|                           | <b>WD-RKV 36-*M</b><br><b>WD-WKV 36-*M</b> | <b>WD-RSV 36-*M</b><br><b>WD-WSV 36-*M</b> | PP White, 3x16 AWG, 105 °C, 600 V, 10 A, 7.2 mm OD, Cable #RF51444-*M | <b>Male</b><br>1. GN<br>2. BK<br>3. WH<br>            |
| <p><b>WD-RSV ..**</b></p> | <b>WD-RKV 40-*M</b><br><b>WD-WKV 40-*M</b> | <b>WD-RSV 40-*M</b><br><b>WD-WSV 40-*M</b> | PP White, 4x18 AWG, 105 °C, 300 V, 9 A, 6.2 mm OD, Cable #RF51445-*M  | <b>Female</b><br>1. BN<br>2. WH<br>3. BU<br>4. BK<br> |
|                           | <b>WD-RKV 46-*M</b><br><b>WD-WKV 46-*M</b> | <b>WD-RSV 46-*M</b><br><b>WD-WSV 46-*M</b> | PP White, 4x16 AWG, 105 °C, 600 V, 10 A, 7.2 mm OD, Cable #RF51446-*M | <b>Male</b><br>1. BK<br>2. WH<br>3. RD<br>4. GN<br>   |

We reserve the right to make technical alterations without prior notice.

\* Length in meters. Standard cable lengths are 2, 4, 5, 6, 8 and 10 meters. Consult factory for other lengths.

\*\* Standard coupling nut material is stainless steel.



## 5 and 6-Wire Washdown Cordsets

- NEMA 1, 3, 4, 6P
- IEC IP67 Protection
- Polypropylene Contact Holder, Mold Material and Cable Jacket
- High Chemical Solvent Resistance & Tensile Strength



| Connector Style           | Female Part Number                                 | Male Part Number                                   | Features   | Pinout  |
|---------------------------|--|--|--|---|
| <p><b>WD-RKV ..**</b></p> | <p><b>WD-RKV 50-*M</b><br/><b>WD-WKV 50-*M</b></p> | <p><b>WD-RSV 50-*M</b><br/><b>WD-WSV 50-*M</b></p> | <p>PP White, 5x18 AWG,<br/>105 °C, 300 V, 9 A, 7.2 mm<br/>OD, Cable #RF51447-*M</p>  | <p>1. BK<br/>2. BU<br/>3. GN/YE<br/>4. BN<br/>5. WH</p> <p><b>Female</b></p>        |
| <p><b>WD-WKV ..**</b></p> | <p><b>WD-RKV 56-*M</b><br/><b>WD-WKV 56-*M</b></p> | <p><b>WD-RSV 56-*M</b><br/><b>WD-WSV 56-*M</b></p> | <p>PP White, 5x16 AWG,<br/>105 °C, 600 V, 10 A, 7.2 mm<br/>OD, Cable #RF51448-*M</p> | <p>1. WH<br/>2. RD<br/>3. GN<br/>4. OG<br/>5. BK</p> <p><b>Male</b></p>             |
| <p><b>WD-RSV ..**</b></p> | <p><b>WD-RKV 60-*M</b><br/><b>WD-WKV 60-*M</b></p> | <p><b>WD-RSV 60-*M</b><br/><b>WD-WSV 60-*M</b></p> | <p>PP White, 6x18 AWG,<br/>105 °C, 300 V, 8 A, 7.2 mm<br/>OD, Cable #RF51449-*M</p>  | <p>1. GN<br/>2. WH<br/>3. BU<br/>4. GY<br/>5. YE<br/>6. BN</p> <p><b>Female</b></p> |
| <p><b>WD-WSV ..**</b></p> | <p><b>WD-RKV 66-*M</b><br/><b>WD-WKV 66-*M</b></p> | <p><b>WD-RSV 66-*M</b><br/><b>WD-WSV 66-*M</b></p> | <p>PP White, 6x16 AWG,<br/>105 °C, 600 V, 8 A, 8.0 mm<br/>OD, Cable #RF51450-*M</p>  | <p>1. WH<br/>2. RD<br/>3. GN<br/>4. OG<br/>5. BK<br/>6. BU</p> <p><b>Male</b></p>   |

We reserve the right to make technical alterations without prior notice.

Cordsets

\* Length in meters. Standard cable lengths are 2, 4, 5, 6, 8 and 10 meters. Consult factory for other lengths.  
 \*\* Standard coupling nut material is stainless steel.

| Mounting Style            | Image                     | Panel Thread Types  | Page               |            |                           |                           |            |                     |                   |                      |             |            |  |
|---------------------------|---------------------------|---|--------------------|------------|---------------------------|---------------------------|------------|---------------------|-------------------|----------------------|-------------|------------|--|
| <p><b>Front Mount</b></p> |                           | <table border="1"> <tr> <td><b>1/2-14 NPSM</b></td> <td><b>F25</b></td> </tr> <tr> <td><b>1/2-14 NPT</b></td> <td><b>F29, F36, F38, F40</b></td> </tr> <tr> <td><b>M20</b></td> <td><b>F32-F35, F41</b></td> </tr> <tr> <td><b>3/4-14 NPT</b></td> <td><b>F37, F39, F40</b></td> </tr> <tr> <td><b>PG16</b></td> <td><b>F41</b></td> </tr> </table> | <b>1/2-14 NPSM</b> | <b>F25</b> | <b>1/2-14 NPT</b>         | <b>F29, F36, F38, F40</b> | <b>M20</b> | <b>F32-F35, F41</b> | <b>3/4-14 NPT</b> | <b>F37, F39, F40</b> | <b>PG16</b> | <b>F41</b> |  |
| <b>1/2-14 NPSM</b>        | <b>F25</b>                |   |                    |            |                           |                           |            |                     |                   |                      |             |            |  |
| <b>1/2-14 NPT</b>         | <b>F29, F36, F38, F40</b> |   |                    |            |                           |                           |            |                     |                   |                      |             |            |  |
| <b>M20</b>                | <b>F32-F35, F41</b>       |   |                    |            |                           |                           |            |                     |                   |                      |             |            |  |
| <b>3/4-14 NPT</b>         | <b>F37, F39, F40</b>      |   |                    |            |                           |                           |            |                     |                   |                      |             |            |  |
| <b>PG16</b>               | <b>F41</b>                |   |                    |            |                           |                           |            |                     |                   |                      |             |            |  |
| <p><b>Rear Mount</b></p>  |                           | <table border="1"> <tr> <td><b>M30</b></td> <td><b>F42</b></td> </tr> <tr> <td><b>Bulkhead Feed-thru</b></td> <td><b>F47</b></td> </tr> </table>  | <b>M30</b>         | <b>F42</b> | <b>Bulkhead Feed-thru</b> | <b>F47</b>                |            |                     |                   |                      |             |            |  |
| <b>M30</b>                | <b>F42</b>                |   |                    |            |                           |                           |            |                     |                   |                      |             |            |  |
| <b>Bulkhead Feed-thru</b> | <b>F47</b>                |   |                    |            |                           |                           |            |                     |                   |                      |             |            |  |
| <p><b>PCB Mount</b></p>   |                           | <table border="1"> <tr> <td><b>PCB Pins</b></td> <td><b>F45</b></td> </tr> </table>   | <b>PCB Pins</b>    | <b>F45</b> |                           |                           |            |                     |                   |                      |             |            |  |
| <b>PCB Pins</b>           | <b>F45</b>                |   |                    |            |                           |                           |            |                     |                   |                      |             |            |  |

We reserve the right to make technical alterations without prior notice.

2 and 3-Wire Receptacles, Front Mount, 1/2-14 NPSM Threads

- NEMA 1, 3, 4, 6P
- IEC IP67 Protection



| Housing Style  | Female Part Number | Male Part Number                         | Features   | Pinout                        |
|--|--------------------|--|--|-------------------------------|
| <p><b>RKF ..</b></p> <p>Typical panel cutout 22.5 mm</p><br><p><b>RSF ..</b></p> <p>Typical panel cutout 22.5 mm</p> | <b>RKF 20-*M</b>   | <b>RSF 20-*M</b>                         | 2x18 AWG 105 °C, 600 V, 9 A, standard duty           | 1. BN<br>2. BU                |
|  | <b>RKF 26-*M</b>   | <b>RSF 26-*M</b>                         | 2x16 AWG Leads, 105 °C, 600 V, 10 A, heavy duty      | 1. WH<br>2. BK                |
|  | <b>RKF 28-*M</b>   | <b>RSF 28-*M</b>                         | 2x18 AWG, 105 °C, 600 V, 9 A, heavy duty             | 1. WH<br>2. BK                |
|  | <b>RKF 30-*M</b>   | <b>RSF 30-*M</b>                         | 3x18 AWG, 105 °C, 600 V, 9 A, standard duty          | 1. GY/YE<br>2. BN<br>3. BU    |
|  | <b>RKF 31-*M</b>   | <b>RSF 31-*M</b>                         | 3x18 AWG, 105 °C, 600 V, 9 A, standard duty          | 1. BK<br>2. BN<br>3. BU       |
|  | <b>RKF 311-*M</b>  | <b>RSF 311-*M</b>                        | 3x18 AWG, 105 °C, 600 V, 9 A, automotive color code  | 1. GN<br>2. RD/BK<br>3. RD/WH |
|  | <b>RKF 35-*M</b>   | <b>RSF 35-*M</b>                         | 3x16 AWG, 105 °C, 600 V, 10 A, automotive color code |                               |
|  | <b>RKF 36-*M</b>   | <b>RSF 36-*M</b>                         | 3x16 AWG, 105 °C, 600 V, 10 A, heavy duty            | 1. GN<br>2. BK<br>3. WH       |
| <b>RKF 38-*M</b>   | <b>RSF 38-*M</b>   | 3x18 AWG, 105 °C, 600 V, 9 A, heavy duty | 1. GN<br>2. BK<br>3. WH                              |                               |

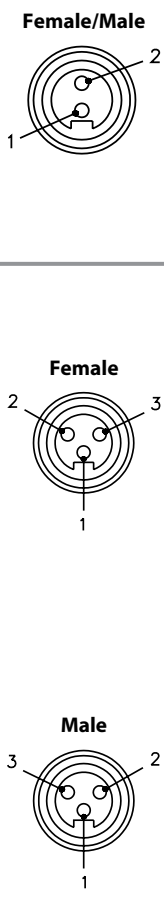

Receptacles

We reserve the right to make technical alterations without prior notice.

Standard lead length is 0.3 meters. Consult factory for other lengths.  
 \*\* Standard housing material is nickel plated brass.. "RSF .."; "RSFV .." indicates stainless steel housing, and "RSFK .." indicates nylon housing.  
 For locknuts to be included, add "W/LN" to the end of the part number. To specify PVC jacketed cable, add "/S717" to the end of the part number.

- NEMA 1, 3, 4, 6P
- IEC IP67 Protection



| Housing Style  | Female Part Number | Male Part Number | Features                                    | Pinout   |
|--|--------------------|------------------|---|--|
| <p><b>RKF ..</b></p> <p>Typical panel cutout 22.5 mm</p> | <b>RKF 40-*M</b>   | <b>RSF 40-*M</b> | 4x18 AWG 105 °C, 600 V, 9 A, standard duty  | <p><b>Female</b></p> <p>1. BN<br/>2. WH<br/>3. BU<br/>4. BK</p> <p><b>Male</b></p>   |
|  | <b>RKF 46-*M</b>   | <b>RSF 46-*M</b> | 4x16 AWG, 105 °C, 600 V, 10 A, heavy duty   | <p><b>Female</b></p> <p>1. BK<br/>2. WH<br/>3. RD<br/>4. GN</p> <p><b>Male</b></p>   |
| <p><b>RSF ..</b></p> <p>Typical panel cutout 22.5 mm</p> | <b>RKF 48-*M</b>   | <b>RSF 48-*M</b> | 3x18 AWG, 105 °C, 600 V, 9 A, standard duty | <p><b>Female</b></p> <p>1. BN<br/>2. N/C<br/>3. BU<br/>4. N/C</p> <p><b>Male</b></p> |

We reserve the right to make technical alterations without prior notice.

Standard lead length is 0.3 meters. Consult factory for other lengths.

\*\* Standard housing material is nickel plated brass. "RSF .."; "RSFV .." indicates stainless steel housing, and "RSFK .." indicates nylon housing. For locknuts to be included, add "W/LN" to the end of the part number. To specify PVC jacketed cable, add "/S717" to the end of the part number.

## 5-Wire Receptacles, Front Mount, 1/2-14 NPSM Threads

- NEMA 1, 3, 4, 6P
- IEC IP67 Protection



| Housing Style        | Female Part Number | Male Part Number  | Features   | Pinout  |
|----------------------|--------------------|-------------------|--|---|
| <p><b>RKF ..</b></p> | <b>RKF 50-*M</b>   | <b>RSF 50-*M</b>  | 5x18 AWG, 105 °C, 600 V, 9 A, standard duty          | 1. BK<br>2. BU<br>3. GN/YE<br>4. BN<br>5. WH          |
|                      | <b>RKF 511-*M</b>  | <b>RSF 511-*M</b> | 5x18 AWG, 105 °C, 600 V, 9 A, automotive color code  | <p><b>Female</b></p>                                  |
| <p><b>RSF ..</b></p> | <b>RKF 55-*M</b>   | <b>RSF 55-*M</b>  | 5x16 AWG, 105 °C, 600 V, 10 A, automotive color code | 1. RD/WH<br>2. RD/BU<br>3. GN<br>4. RD/OG<br>5. RD/BK |
|                      | <b>RKF 56-*M</b>   | <b>RSF 56-*M</b>  | 5x16 AWG, 105 °C, 600 V, 10 A, heavy duty            | <p><b>Male</b></p>                                    |
|                      | <b>RKF 58-*M</b>   | <b>RSF 58-*M</b>  | 5x18 AWG, 105 °C, 300 V, 9 A, heavy duty             | 1. WH<br>2. RD<br>3. GN<br>4. OG<br>5. BK             |

We reserve the right to make technical alterations without prior notice.

Receptacles

Standard lead length is 0.3 meters. Consult factory for other lengths.

\*\* Standard housing material is nickel plated brass. "RSF .."; "RSFV .." indicates stainless steel housing, and "RSFK .." indicates nylon housing. For locknuts to be included, add "W/LN" to the end of the part number. To specify PVC jacketed cable, add "/S717" to the end of the part number.

- NEMA 1, 3, 4, 6P
- IEC IP67 Protection



| Housing Style  | Female Part Number | Male Part Number | Features                                       | Pinout  |
|--|--------------------|------------------|--|---|
| <p><b>RKF ..</b></p> <p>Typical panel cutout 22.5 mm</p> | <b>RKF 61-*M</b>   | <b>RSF 61-*M</b> | 6x18 AWG, 105 °C, 600 V, 8 A, standard threads | <ol style="list-style-type: none"> <li>GN</li> <li>WH</li> <li>BU</li> <li>Gy</li> <li>YE</li> <li>BN</li> </ol> <p><b>Female</b></p> |
| <p><b>RSF ..</b></p> <p>Typical panel cutout 22.5 mm</p> | <b>RKF 66-*M</b>   | <b>RSF 66-*M</b> | 6x16 AWG, 105 °C, 600 V, 8 A, heavy duty       | <ol style="list-style-type: none"> <li>WH</li> <li>RD</li> <li>GN</li> <li>OG</li> <li>BK</li> <li>BU</li> </ol> <p><b>Male</b></p>   |
| <p><b>RKF ..</b></p> <p>Typical panel cutout 22.5 mm</p> | <b>RKF 68-*M</b>   | <b>RSF 68-*M</b> | 6x18 AWG, 105 °C, 600 V, 8 A, heavy duty       | <ol style="list-style-type: none"> <li>GN</li> <li>WH</li> <li>BU</li> <li>Gy</li> <li>YE</li> <li>BN</li> </ol> <p><b>Female</b></p> |

Standard lead length is 0.3 meters. Consult factory for other lengths.

\*\* Standard housing material is nickel plated brass. "RSF .."; "RSFV .." indicates stainless steel housing, and "RSFK .." indicates nylon housing. For locknuts to be included, add "W/LN" to the end of the part number. To specify PVC jacketed cable, add "/S717" to the end of the part number.

We reserve the right to make technical alterations without prior notice.

2 and 3-Wire Receptacles, Front Mount, 1/2-14 NPT Threads

- NEMA 1, 3, 4, 6P
- IEC IP67 Protection



| Housing Style  | Female Part Number    | Male Part Number                         | Features                                      | Pinout                        |
|--|-----------------------|--|---|-------------------------------|
| <p><b>RKF ..NPT</b></p> <p>Typical panel cutout 22.5 mm</p><br><p><b>RSF ..NPT</b></p> <p>Typical panel cutout 22.5 mm</p> | <b>RKF 20-*M/NPT</b>  | <b>RSF 20-*M/NPT</b>                     | 2x18 AWG, 105 °C, 9 A, standard duty          | 1. BN<br>2. BU                |
|  | <b>RKF 26-*M/NPT</b>  | <b>RSF 26-*M/NPT</b>                     | 2x16 AWG Leads, 105 °C, 10 A, heavy duty      | 1. WH<br>2. BK                |
|  | <b>RKF 28-*M/NPT</b>  | <b>RSF 28-*M/NPT</b>                     | 2x18 AWG, 105 °C, 600 V, 9 A, heavy duty      | 1. WH<br>2. BK                |
|  | <b>RKF 30-*M/NPT</b>  | <b>RSF 30-*M/NPT</b>                     | 3x18 AWG, 105 °C, 9 A, standard duty          | 1. GY/YE<br>2. BN<br>3. BU    |
|  | <b>RKF 31-*M/NPT</b>  | <b>RSF 31-*M/NPT</b>                     | 3x18 AWG, 105 °C, 9 A, standard duty          | 1. BK<br>2. BN<br>3. BU       |
|  | <b>RKF 311-*M/NPT</b> | <b>RSF 311-*M/NPT</b>                    | 3x18 AWG, 105 °C, 9 A, automotive color code  | 1. GN<br>2. RD/BK<br>3. RD/WH |
|  | <b>RKF 35-*M/NPT</b>  | <b>RSF 35-*M/NPT</b>                     | 3x16 AWG, 105 °C, 10 A, automotive color code |                               |
|  | <b>RKF 36-*M/NPT</b>  | <b>RSF 36-*M/NPT</b>                     | 3x16 AWG, 105 °C, 10 A, heavy duty            | 1. GN<br>2. BK<br>3. WH       |
| <b>RKF 38-*M/NPT</b>   | <b>RSF 38-*M/NPT</b>  | 3x18 AWG, 105 °C, 600 V, 9 A, heavy duty | 1. GN<br>2. BK<br>3. WH                       |                               |

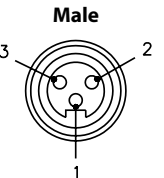
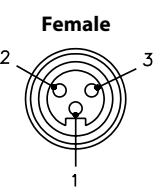
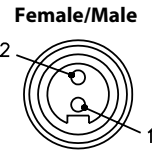

Receptacles

We reserve the right to make technical alterations without prior notice.

Standard lead length is 0.3 meters. Consult factory for other lengths.

\*\* Standard housing material is nickel plated brass.. "RSF .."; "RSFV .." indicates stainless steel housing, and "RSFK .." indicates nylon housing. For locknuts to be included, add "W/LN" to the end of the part number. To specify PVC jacketed cable, add "/S717" to the end of the part number.

- NEMA 1, 3, 4, 6P
- IEC IP67 Protection
- 600 V



| Housing Style   | Female Part Number    | Male Part Number      | Features                             | Pinout                                  |
|---|-----------------------|-----------------------|--------------------------------------|---|
| <p><b>RKF ..NPT</b></p> <p>Typical panel cutout 22.5 mm</p> | <b>RKF 40-*M/NPT</b>  | <b>RSF 40-*M/NPT</b>  | 4x18 AWG, 105 °C, 9 A, standard duty | <p><b>Female</b></p> <p><b>Male</b></p> |
|   | <b>RKF 46-*M/NPT</b>  | <b>RSF 46-*M/NPT</b>  | 4x16 AWG, 105 °C, 10 A, heavy duty   | <p><b>Female</b></p> <p><b>Male</b></p> |
| <p><b>RSF ..NPT</b></p> <p>Typical panel cutout 22.5 mm</p> | <b>RKF 48A-*M/NPT</b> | <b>RSF 48A-*M/NPT</b> | 4x18 AWG, 105 °C, 9 A, heavy duty    | <p><b>Female</b></p> <p><b>Male</b></p> |

We reserve the right to make technical alterations without prior notice.

Standard lead length is 0.3 meters. Consult factory for other lengths.

\*\* Standard housing material is nickel plated brass. "RSF .."; "RSFV .." indicates stainless steel housing, and "RSFK .." indicates nylon housing. For locknuts to be included, add "W/LN" to the end of the part number. To specify PVC jacketed cable, add "/S717" to the end of the part number.



## 5 and 6-Wire Receptacles, Front Mount, 1/2-14 NPT Threads

- NEMA 1, 3, 4, 6P
- IEC IP67 Protection
- 600 V



| Housing Style   | Female Part Number    | Male Part Number      | Features                                      | Pinout  |
|---|-----------------------|-----------------------|---|---|
| <p><b>RKF ..NPT</b></p> <p>Typical panel cutout 22.5 mm</p> | <b>RKF 50-*M/NPT</b>  | <b>RSF 50-*M/NPT</b>  | 5x18 AWG, 105 °C, 9 A, standard duty          | <b>Female</b><br>1. BK<br>2. BU<br>3. GN/YE<br>4. BN<br>5. WH<br>       |
|   | <b>RKF 511-*M/NPT</b> | <b>RSF 511-*M/NPT</b> | 5x18 AWG, 105 °C, 9 A, automotive color code  | 1. RD/WH<br>2. RD/BU<br>3. GN<br>4. RD/OG<br>5. RD/BK<br>               |
|   | <b>RKF 55-*M/NPT</b>  | <b>RSF 55-*M/NPT</b>  | 5x16 AWG, 105 °C, 10 A, automotive color code | <b>Male</b><br>   |
|   | <b>RKF 56-*M/NPT</b>  | <b>RSF 56-*M/NPT</b>  | 5x16 AWG, 105 °C, 10 A, heavy duty            | 1. WH<br>2. RD<br>3. GN<br>4. OG<br>5. BK                               |
|   | <b>RKF 58-*M/NPT</b>  | <b>RSF 58-*M/NPT</b>  | 5x18 AWG, 105 °C, 300 V, 9 A, heavy duty      |   |
| <p><b>RSF ..NPT</b></p> <p>Typical panel cutout 22.5 mm</p> | <b>RKF 61-*M/NPT</b>  | <b>RSF 61-*M/NPT</b>  | 6x18 AWG, 105 °C, 8 A, standard duty          | <b>Female</b><br>1. GN<br>2. WH<br>3. BU<br>4. GY<br>5. YE<br>6. BN<br> |
|   | <b>RKF 66-*M/NPT</b>  | <b>RSF 66-*M/NPT</b>  | 6x16 AWG, 105 °C, 8 A, heavy duty             | <b>Male</b><br>   |
|   | <b>RKF 68-*M/NPT</b>  | <b>RSF 68-*M/NPT</b>  | 6x18 AWG, 105 °C, 600 V, 8 A, heavy duty      | 1. WH<br>2. RD<br>3. GN<br>4. OG<br>5. BK<br>6. BU                      |

We reserve the right to make technical alterations without prior notice.

Receptacles

Standard lead length is 0.3 meters. Consult factory for other lengths.

\*\* Standard housing material is nickel plated brass.. "RSF .."; "RSFV .." indicates stainless steel housing, and "RSFK .." indicates nylon housing. For locknuts to be included, add "W/LN" to the end of the part number. To specify PVC jacketed cable, add "/S717" to the end of the part number.

- NEMA 1, 3, 4, 6P
- IEC IP67 Protection
- 600 V



| Housing Style   | Female Part Number    | Male Part Number      | Features                                      | Pinout  |
|---|-----------------------|-----------------------|---|---|
| <p><b>RKF ..M20</b></p> <p>Typical panel cutout 22.5 mm</p> | <b>RKF 20-*M/M20</b>  | <b>RSF 20-*M/M20</b>  | 2x18 AWG, 105 °C, 9 A, standard duty          | <b>Female/Male</b><br><br>1. BN<br>2. BU              |
|   | <b>RKF 26-*M/M20</b>  | <b>RSF 26-*M/M20</b>  | 2x16 AWG Leads, 105 °C, 10 A, heavy duty      | 1. WH<br>2. BK  |
|   | <b>RKF 30-*M/M20</b>  | <b>RSF 30-*M/M20</b>  | 3x18 AWG, 105 °C, 9 A standard duty           | <b>Female</b><br><br>1. GY/YE<br>2. BN<br>3. BU       |
|   | <b>RKF 31-*M/M20</b>  | <b>RSF 31-*M/M20</b>  | 3x18 AWG, 105 °C, 9 A standard duty           | 1. BK<br>2. BN<br>3. BU                               |
|   | <b>RKF 311-*M/M20</b> | <b>RSF 311-*M/M20</b> | 3x18 AWG, 105 °C, 9 A automotive color code   | <b>Male</b><br><br>1. GN<br>2. RD/BK<br>3. RD/WH      |
|   | <b>RKF 35-*M/M20</b>  | <b>RSF 35-*M/M20</b>  | 3x16 AWG, 105 °C, 10 A, automotive color code |   |
|   | <b>RKF 36-*M/M20</b>  | <b>RSF 36-*M/M20</b>  | 3x16 AWG, 105 °C, 10 A, heavy duty            | 1. GN<br>2. BK<br>3. WH                               |
| <p><b>RSF ..M20</b></p> <p>Typical panel cutout 22.5 mm</p> | <b>RKF 40-*M/M20</b>  | <b>RSF 40-*M/M20</b>  | 4x18 AWG, 105 °C, 9 A standard duty           | <b>Female</b><br><br>1. BN<br>2. WH<br>3. BU<br>4. BK |
|   | <b>RKF 46-*M/M20</b>  | <b>RSF 46-*M/M20</b>  | 4x16 AWG, 105 °C, 10 A heavy duty             | <b>Male</b><br><br>1. BK<br>2. WH<br>3. RD<br>4. GN   |

We reserve the right to make technical alterations without prior notice.

Standard lead length is 0.3 meters. Consult factory for other lengths.

\*\* Standard housing material is nickel plated brass.. "RSF .."; "RSFV .." indicates stainless steel housing, and "RSFK .." indicates nylon housing.  
 For locknuts to be included, add "W/LN" to the end of the part number. To specify PVC jacketed cable, add "/S717" to the end of the part number.

5 and 6-Wire Receptacles, Front Mount, M20 Threads

- NEMA 1, 3, 4, 6P
- IEC IP67 Protection
- 600 V



| Housing Style   | Female Part Number  | Male Part Number      | Features   | Pinout  |  |
|---|---|-----------------------|--|---|--|
| <p><b>RKF ..M20</b></p> <p>Typical panel cutout 22.5 mm</p> | <b>RKF 50-*M/M20</b>  | <b>RSF 50-*M/M20</b>  | 5x18 AWG, 105 °C,<br>9 A standard duty           | 1. BK<br>2. BU<br>3. GN/YE<br>4. BN<br>5. WH<br>          |  |
|   | <b>RKF 511-*M/M20</b>                                       | <b>RSF 511-*M/M20</b> | 5x18 AWG, 105 °C,<br>9 A automotive color code   | 1. RD/WH<br>2. RD/BU<br>3. GN<br>4. RD/OG<br>5. RD/BK<br> |  |
|   | <b>RKF 55-*M/M20</b>  | <b>RSF 55-*M/M20</b>  | 5x16 AWG, 105 °C,<br>10 A, automotive color code | 1. WH<br>2. RD<br>3. GN<br>4. OG<br>5. BK<br>             |  |
|   | <b>RKF 56-*M/M20</b>  | <b>RSF 56-*M/M20</b>  | 5x16 AWG, 105 °C,<br>10 A, heavy duty            | 1. WH<br>2. RD<br>3. GN<br>4. OG<br>5. BK<br>             |  |
|   | <p><b>RSF ..M20</b></p> <p>Typical panel cutout 22.5 mm</p> | <b>RKF 61-*M/M20</b>  | <b>RSF 61-*M/M20</b>                             | 6x18 AWG, 105 °C,<br>8 A standard duty                    | 1. GN<br>2. WH<br>3. BU<br>4. GY<br>5. YE<br>6. BN<br> |
|   |   | <b>RKF 66-*M/M20</b>  | <b>RSF 66-*M/M20</b>                             | 6x16 AWG, 105 °C,<br>8 A heavy duty                       | 1. WH<br>2. RD<br>3. GN<br>4. OG<br>5. BK<br>6. BU<br> |

We reserve the right to make technical alterations without prior notice.

Receptacles

Standard lead length is 0.3 meters. Consult factory for other lengths.

\*\* Standard housing material is nickel plated brass.. "RSF .."; "RSFV .." indicates stainless steel housing, and "RSFK .." indicates nylon housing. For locknuts to be included, add "W/LN" to the end of the part number. To specify PVC jacketed cable, add "/S717" to the end of the part number.

- NEMA 1, 3, 4, 6P
- IEC IP68 Protection
- 600 V, 8 A



| Housing Style   | Female Part Number    | Male Part Number      | Features         | Pinout   |
|---|-----------------------|-----------------------|------------------|--|
| <p><b>RKF ..M20</b></p> <p>Typical panel cutout 22.5 mm</p> | <b>RKF 6B6-*M/M20</b> | <b>RSF 6B6-*M/M20</b> | 6x16 AWG, 105 °C | <p><b>Female</b></p> <p>1. OG<br/>2. BU<br/>3. BK<br/>4. WH<br/>5. RD<br/>6. GN</p> <p><b>Male</b></p>                           |
|   | <b>RKF 76-*M/M20</b>  | <b>RSF 76-*M/M20</b>  | 7x16 AWG, 105 °C | <p><b>Female</b></p> <p>1. WH/BK<br/>2. BK<br/>3. WH<br/>4. RD<br/>5. OG<br/>6. BU<br/>7. GN</p> <p><b>Male</b></p>              |
| <p><b>RSF ..M20</b></p> <p>Typical panel cutout 22.5 mm</p> | <b>RKF 86-*M/M20</b>  | <b>RSF 86-*M/M20</b>  | 8x16 AWG, 105 °C | <p><b>Female</b></p> <p>1. OG<br/>2. BU<br/>3. WH/BK<br/>4. BK<br/>5. WH<br/>6. RD<br/>7. GN<br/>8. RD/BK</p> <p><b>Male</b></p> |

We reserve the right to make technical alterations without prior notice.

Standard lead length is 0.3 meters. Consult factory for other lengths.

\*\* Standard housing material is nickel plated brass.. "RSF .."; "RSFV .." indicates stainless steel housing, and "RSFK .." indicates nylon housing.  
For locknuts to be included, add "W/LN" to the end of the part number. To specify PVC jacketed cable, add "/S717" to the end of the part number.

## 9, 10 and 12-Wire Receptacles, Front Mount, M20 Threads

- NEMA 1, 3, 4, 6P
- IEC IP68 Protection
- 600 V, 7 A



We reserve the right to make technical alterations without prior notice.

| Housing Style   | Female Part Number    | Male Part Number      | Features          | Pinout  |
|---|-----------------------|-----------------------|-------------------|---|
| <p><b>RKF ..M20</b></p> <p>Typical panel cutout 22.5 mm</p> | <b>RKF 96-*M/M20</b>  | <b>RSF 96-*M/M20</b>  | 9x16 AWG, 105 °C  | <p><b>Female</b></p> <p>1. OG<br/>2. BU<br/>3. RD/BK<br/>4. GN/BK<br/>5. WH<br/>6. RD<br/>7. GN</p> <p><b>Male</b></p> <p>4. 3<br/>9. 8<br/>5. 2<br/>6. 1<br/>7. 7</p>  |
|   | <b>RKF 106-*M/M20</b> | <b>RSF 106-*M/M20</b> | 10x16 AWG, 105 °C | <p><b>Female</b></p> <p>1. OG<br/>2. BU<br/>3. WH/BK<br/>4. RD/BK<br/>5. GN/BK<br/>6. OG/BK<br/>7. RD<br/>8. GN</p> <p><b>Male</b></p> <p>5. 4 3<br/>9. 8<br/>10. 7<br/>6. 2<br/>7. 1<br/>8. 8</p>  |
| <p><b>RSF ..M20</b></p> <p>Typical panel cutout 22.5 mm</p> | <b>RKF 126-*M/M20</b> | <b>RSF 126-*M/M20</b> | 12x16 AWG, 105 °C | <p><b>Female</b></p> <p>1. OG<br/>2. BU<br/>3. WH/BK<br/>4. RD/BK<br/>5. GN/BK<br/>6. OG/BK<br/>7. BU/BK<br/>8. BK/WH<br/>9. GN<br/>10. RD/BK<br/>11. WH<br/>12. BK</p> <p><b>Male</b></p> <p>4. 11 5 6<br/>3. 7<br/>2. 8<br/>1. 10 9 12<br/>5. 4 3<br/>6. 2<br/>7. 1<br/>8. 8<br/>12. 9 10</p> |

Receptacles

Standard lead length is 0.3 meters. Consult factory for other lengths.

\*\* Standard housing material is nickel plated brass.. "RSF .."; "RSFV .." indicates stainless steel housing, and "RSFK .." indicates nylon housing.  
For locknuts to be included, add "W/LN" to the end of the part number. To specify PVC jacketed cable, add "/S717" to the end of the part number.

- NEMA 1, 3, 4, 6P
- IEC IP68 Protection
- 600 V, 8 A



| Housing Style   | Female Part Number         | Male Part Number           | Features                                | Pinout                                  |
|---|----------------------------|----------------------------|---|---|
| <p><b>RKF ..1/2-14NPT</b></p> <p>Typical panel cutout 22.5 mm</p> | <b>RKF 6B6-*M/14.5/NPT</b> | <b>RSF 6B6-*M/14.5/NPT</b> | 6x16 AWG, 105 °C,<br>1/2-14 NPT threads | <p><b>Female</b></p> <p><b>Male</b></p> |
| <p><b>RSF ..1/2-14NPT</b></p> <p>Typical panel cutout 22.5 mm</p> | <b>RKF 76-*M/14.5/NPT</b>  | <b>RSF 76-*M/14.5/NPT</b>  | 7x16 AWG, 105 °C,<br>1/2-14 NPT threads | <p><b>Female</b></p> <p><b>Male</b></p> |
| <p><b>RSF ..1/2-14NPT</b></p> <p>Typical panel cutout 22.5 mm</p> | <b>RKF 86-*M/14.5/NPT</b>  | <b>RSF 86-*M/14.5/NPT</b>  | 8x16 AWG, 105 °C,<br>1/2-14 NPT threads | <p><b>Female</b></p> <p><b>Male</b></p> |

We reserve the right to make technical alterations without prior notice.

Standard lead length is 0.3 meters. Consult factory for other lengths.

\*\* Standard housing material is nickel plated brass.. "RSF .."; "RSFV .." indicates stainless steel housing, and "RSFK .." indicates nylon housing.

For locknuts to be included, add "W/LN" to the end of the part number. To specify PVC jacketed cable, add "/S717" to the end of the part number.

## 6, 7 and 8-Wire Receptacles, Front Mount

- NEMA 1, 3, 4, 6P
- IEC IP68 Protection
- 600 V, 8 A



We reserve the right to make technical alterations without prior notice.

| Housing Style   | Female Part Number          | Male Part Number            | Features                                | Pinout   |
|---|-----------------------------|-----------------------------|---|--|
| <p><b>RKF ..3/4-14NPT</b></p> <p>Typical panel cutout 22.5 mm</p> | <b>RKF 6B6-*M/14.75/NPT</b> | <b>RSF 6B6-*M/14.75/NPT</b> | 6x16 AWG, 105 °C,<br>3/4-14 NPT threads | <p><b>Female</b></p> <p>1. OG<br/>2. BU<br/>3. BK<br/>4. WH<br/>5. RD<br/>6. GN</p> <p><b>Male</b></p>                           |
| <p><b>RSF ..3/4-14NPT</b></p> <p>Typical panel cutout 22.5 mm</p> | <b>RKF 76-*M/14.75/NPT</b>  | <b>RSF 76-*M/14.75/NPT</b>  | 7x16 AWG, 105 °C,<br>3/4-14 NPT threads | <p><b>Female</b></p> <p>1. WH/BK<br/>2. BK<br/>3. WH<br/>4. RD<br/>5. OG<br/>6. BU<br/>7. GN</p> <p><b>Male</b></p>              |
| <p><b>RSF ..3/4-14NPT</b></p> <p>Typical panel cutout 22.5 mm</p> | <b>RKF 86-*M/14.75/NPT</b>  | <b>RSF 86-*M/14.75/NPT</b>  | 8x16 AWG, 105 °C,<br>3/4-14 NPT threads | <p><b>Female</b></p> <p>1. OG<br/>2. BU<br/>3. WH/BK<br/>4. BK<br/>5. WH<br/>6. RD<br/>7. GN<br/>8. RD/BK</p> <p><b>Male</b></p> |

Receptacles

Standard lead length is 0.3 meters. Consult factory for other lengths.

\*\* Standard housing material is nickel plated brass.. "RSF .."; "RSFV .." indicates stainless steel housing, and "RSFK .." indicates nylon housing.  
For locknuts to be included, add "W/LN" to the end of the part number. To specify PVC jacketed cable, add "/S717" to the end of the part number.

# 1 1/8" minifast® Connectivity Products

## 9, 10 and 12-Wire Receptacles, Front Mount



- NEMA 1, 3, 4, 6P
- IEC IP68 Protection
- 600 V, 7 A



| Housing Style  | Female Part Number         | Male Part Number           | Features                                 | Pinout   |
|--|----------------------------|----------------------------|--|--|
| <p><b>RKF ...1/2-14NPT</b></p> <p>Typical panel cutout 22.5 mm</p> | <b>RKF 96-*M/14.5/NPT</b>  | <b>RSF 96-*M/14.5/NPT</b>  | 9x16 AWG, 105 °C,<br>1/2-14 NPT threads  | <p><b>Female</b></p> <p>1. OG<br/>2. BU<br/>3. RD/BK<br/>4. GN/BK<br/>5. WH<br/>6. RD<br/>7. GN</p> <p><b>Male</b></p> <p>4. 3<br/>9. 8<br/>5. 2<br/>6. 1<br/>6. 7<br/>1. 1</p>  |
|  | <b>RKF 106-*M/14.5/NPT</b> | <b>RSF 106-*M/14.5/NPT</b> | 10x16 AWG, 105 °C,<br>1/2-14 NPT threads | <p><b>Female</b></p> <p>1. OG<br/>2. BU<br/>3. WH/BK<br/>4. RD/BK<br/>5. GN/BK<br/>6. OG/BK<br/>7. RD<br/>8. GN<br/>9. BK<br/>10. WH</p> <p><b>Male</b></p> <p>5. 4 3<br/>9. 9<br/>10. 2<br/>6. 1<br/>7. 8<br/>8. 1</p>  |
| <p><b>RSF ..1/2-14NPT</b></p> <p>Typical panel cutout 22.5 mm</p>  | <b>RKF 126-*M/14.5/NPT</b> | <b>RSF 126-*M/14.5/NPT</b> | 12x16 AWG, 105 °C,<br>1/2-14 NPT threads | <p><b>Female</b></p> <p>1. OG<br/>2. BU<br/>3. WH/BK<br/>4. RD/BK<br/>5. GN/BK<br/>6. OG/BK<br/>7. BU/BK<br/>8. BK/WH<br/>9. GN<br/>10. RD<br/>11. WH<br/>12. BK</p> <p><b>Male</b></p> <p>4. 11 5 6<br/>3. 7<br/>2. 8<br/>1. 10 9 12<br/>5. 11 4 3<br/>6. 2<br/>7. 1<br/>8. 12 9 10</p> |

We reserve the right to make technical alterations without prior notice.

Standard lead length is 0.3 meters. Consult factory for other lengths.

\*\* Standard housing material is nickel plated brass.. "RSF .."; "RSFV .." indicates stainless steel housing, and "RSFK .." indicates nylon housing.

For locknuts to be included, add "W/LN" to the end of the part number. To specify PVC jacketed cable, add "/S717" to the end of the part number.



## 9, 10 and 12-Wire Receptacles, Front Mount

- NEMA 1, 3, 4, 6P
- IEC IP68 Protection
- 600 V, 7 A



We reserve the right to make technical alterations without prior notice.

| Housing Style   | Female Part Number          | Male Part Number            | Features                                 | Pinout  |
|---|-----------------------------|-----------------------------|--|---|
| <p><b>RKF ..3/4-14NPT</b></p> <p>Typical panel cutout 22.5 mm</p> | <b>RKF 96-*M/14.75/NPT</b>  | <b>RSF 96-*M/14.75/NPT</b>  | 9x16 AWG, 105 °C,<br>3/4-14 NPT threads  | <p><b>Female</b></p> <p>1. OG<br/>2. BU<br/>3. RD/BK<br/>4. GN/BK<br/>5. WH<br/>6. RD<br/>7. GN<br/>8. WH/BK<br/>9. BK</p> <p><b>Male</b></p>   |
|   | <b>RKF 106-*M/14.75/NPT</b> | <b>RSF 106-*M/14.75/NPT</b> | 10x16 AWG, 105 °C,<br>3/4-14 NPT threads | <p><b>Female</b></p> <p>1. OG<br/>2. BU<br/>3. WH/BK<br/>4. RD/BK<br/>5. GN/BK<br/>6. OG/BK<br/>7. RD<br/>8. GN<br/>9. BK<br/>10. WH</p> <p><b>Male</b></p>                             |
| <p><b>RSF ..3/4-14NPT</b></p> <p>Typical panel cutout 22.5 mm</p> | <b>RKF 126-*M/14.75/NPT</b> | <b>RSF 126-*M/14.75/NPT</b> | 12x16 AWG, 105 °C,<br>3/4-14 NPT threads | <p><b>Female</b></p> <p>1. OG<br/>2. BU<br/>3. WH/BK<br/>4. RD/BK<br/>5. GN/BK<br/>6. OG/BK<br/>7. BU/BK<br/>8. BK/WH<br/>9. GN<br/>10. RD<br/>11. WH<br/>12. BK</p> <p><b>Male</b></p> |

Receptacles

Standard lead length is 0.3 meters. Consult factory for other lengths.

\*\* Standard housing material is nickel plated brass.. "RSF .."; "RSFV .." indicates stainless steel housing, and "RSFK .." indicates nylon housing.  
For locknuts to be included, add "W/LN" to the end of the part number. To specify PVC jacketed cable, add "/S717" to the end of the part number.

- NEMA 1, 3, 4, 6P
- IEC IP68 Protection
- 300 V, 4 A (pins 5, 7, 12), 2 A (all others)



| Housing Style  | Female Part Number   | Male Part Number     | Features                                    | Pinout   |
|--|----------------------|----------------------|---|--|
| <p><b>RSF ..1/2-14NPT</b></p> <p>Typical panel cutout 22.5 mm</p>  | RKF 190-*M/14.5/NPT  | RSF 190-*M/14.5/NPT  | 3x18, 16x22 AWG, 105 °C, 1/2-14 NPT threads | <p><b>Female</b></p> <p>1. VT<br/>2. RD<br/>3. GY<br/>4. RD/BU<br/>5. BU<br/>6. GN<br/>7. BN<br/>8. WH/GN<br/>9. WH/YE<br/>10. WH/GY<br/>11. BK<br/>12. GN/YE<br/>13. YE/BN<br/>14. BN/GN<br/>15. WH<br/>16. YE<br/>17. PK<br/>18. GY/BN<br/>19. GY/PK</p> |
| <p><b>RKF ...1/2-14NPT</b></p> <p>Typical panel cutout 22.5 mm</p> |                      |                      |   |  |
| <p><b>RSF ..3/4-14NPT</b></p> <p>Typical panel cutout 22.5 mm</p>  | RKF 190-*M/14.75/NPT | RSF 190-*M/14.75/NPT | 3x18, 16x22 AWG 105 °C, 3/4-14 NPT threads  | <p><b>Male</b></p>   |
| <p><b>RKF ..3/4-14NPT</b></p> <p>Typical panel cutout 22.5 mm</p>  |                      |                      |   |  |

We reserve the right to make technical alterations without prior notice.

Standard lead length is 0.3 meters. Consult factory for other lengths.

\*\* Standard housing material is nickel plated brass. "RSF .."; "RSFV .." indicates stainless steel housing, and "RSFK .." indicates nylon housing. For locknuts to be included, add "W/LN" to the end of the part number. To specify PVC jacketed cable, add "/S717" to the end of the part number.

## 19-Wire Receptacles, Front Mount

- NEMA 1, 3, 4, 6P
- IEC IP68 Protection
- 300 V, 4 A (pins 5, 7, 12), 2 A (all others)



We reserve the right to make technical alterations without prior notice.

| Housing Style   | Female Part Number             | Male Part Number               | Features  | Pinout               |
|---|--------------------------------|--------------------------------|---|----------------------|
| <p><b>RKF ..PG16</b></p> <p><b>Typical panel cutout 22.5 mm</b></p> | <p><b>RKF 190-*M/PG 16</b></p> | <p><b>RSF 190-*M/PG 16</b></p> | <p>3x18, 16x22 AWG,<br/>105 °C, PG 16<br/>threads</p> | <p><b>Female</b></p> |
| <p><b>RSF ..PG16</b></p> <p><b>Typical panel cutout 22.5 mm</b></p> |                                |                                |   |                      |
| <p><b>RKF ...M20</b></p> <p><b>Typical panel cutout 22.5 mm</b></p> | <p><b>RKF 190-*M/M20</b></p>   | <p><b>RSF 190-*M/M20</b></p>   | <p>3x18, 16x22 AWG,<br/>105 °C, M20 threads</p>       | <p><b>Male</b></p>   |
| <p><b>RSF ..M20</b></p> <p><b>Typical panel cutout 22.5 mm</b></p>  |                                |                                |   |                      |

Receptacles

Standard lead length is 0.3 meters. Consult factory for other lengths.

\*\* Standard housing material is nickel plated brass.. "RSF .."; "RSFV .." indicates stainless steel housing, and "RSFK .." indicates nylon housing.  
For locknuts to be included, add "W/LN" to the end of the part number. To specify PVC jacketed cable, add "/S717" to the end of the part number.

- NEMA 1, 3, 4, 6P
- IEC IP68 Protection
- 600 V



| Housing Style  | Female Part Number | Male Part Number   | Features   | Pinout                                       |
|--|--------------------|--------------------|--|--|
| <p><b>RKFP ..</b></p> <p><b>RKFP Cutout</b></p> <p>Recommended maximum panel thickness is 6.4 mm</p> | <b>RKFP 20-*M</b>  | <b>RSFP 20-*M</b>  | 2x18 AWG, 105 °C, 9 A, M30x1.5 threads, standard duty          | 1. BN<br>2. BU<br><br><b>Female/Male</b><br> |
|  | <b>RKFP 26-*M</b>  | <b>RSFP 26-*M</b>  | 2x16 AWG, 105 °C, 10 A, M30x1.5 threads, heavy duty            | 1. WH<br>2. BK                               |
|  | <b>RKFP 30-*M</b>  | <b>RSFP 30-*M</b>  | 3x18 AWG, 105 °C, 9 A, M30x1.5 threads, standard duty          | 1. GN/YE<br>2. BN<br>3. BU                   |
| <p><b>RSFP ..</b></p> <p><b>RSFP Cutout</b></p> <p>Recommended maximum panel thickness is 6.4 mm</p> | <b>RKFP 31-*M</b>  | <b>RSFP 31-*M</b>  | 3x18 AWG, 105 °C, 9 A, M30x1.5 threads, standard duty          | <b>Female</b><br>                            |
|  | <b>RKFP 311-*M</b> | <b>RSFP 311-*M</b> | 3x18 AWG, 105 °C, 9 A, M30x1.5 threads, automotive color code  | 1. GN<br>2. RD/BK<br>3. RD/WH                |
|  | <b>RKFP 35-*M</b>  | <b>RSFP 35-*M</b>  | 3x16 AWG, 105 °C, 10 A, automotive color code, M30x1.5 Threads | <b>Male</b><br>                              |
|  | <b>RKFP 36-*M</b>  | <b>RSFP 36-*M</b>  | 3x16 AWG, 105 °C, 10 A, M30x1.5 threads, heavy duty            | 1. GN<br>2. BK<br>3. WH                      |

We reserve the right to make technical alterations without prior notice.

Standard lead length is 0.3 meters. Consult factory for other lengths.

\*\* Standard housing material is nickel plated brass.. "RSFP .."; "RSFPV .." indicates stainless steel housing.  
To specify PVC jacketed cable, add "/S717" to the end of the part number.

4-Wire Receptacles, Back Panel Mount

- NEMA 1, 3, 4, 6P
- IEC IP68 Protection
- 600 V



| Housing Style  | Female Part Number | Male Part Number  | Features  | Pinout                                  |
|--|--------------------|-------------------|---|---|
| <p><b>RKFP ..</b></p> <p><b>RKFP Cutout</b></p> <p>Recommended maximum panel thickness is 6.4 mm</p> | <b>RKFP 40-*M</b>  | <b>RSFP 40-*M</b> | 4x18 AWG, 105 °C,<br>9 A, M30x1.5 Threads,<br>Standard Duty | <p><b>Female</b></p> <p><b>Male</b></p> |
| <p><b>RSFP ..</b></p> <p><b>RSFP Cutout</b></p> <p>Recommended maximum panel thickness is 6.4 mm</p> | <b>RKFP 46-*M</b>  | <b>RSFP 46-*M</b> | 4x16 AWG, 105 °C,<br>10 A, M30x1.5<br>Threads, Heavy Duty   | <p><b>Female</b></p> <p><b>Male</b></p> |

We reserve the right to make technical alterations without prior notice.

Receptacles

Standard lead length is 0.3 meters. Consult factory for other lengths.

\*\* Standard housing material is nickel plated brass.. "RSFP .."; "RSFPV .." indicates stainless steel housing.  
To specify PVC jacketed cable, add "/S717" to the end of the part number.

- NEMA 1, 3, 4, 6P
- IEC IP68 Protection
- 600 V



| Housing Style  | Female Part Number | Male Part Number   | Features   | Pinout  |
|--|--------------------|--------------------|--|---|
| <p><b>RKFP ..</b></p> <p><b>RKFP Cutout</b></p> <p>Recommended maximum panel thickness is 6.4 mm</p> | <b>RKFP 50-*M</b>  | <b>RSFP 50-*M</b>  | 5x18 AWG, 105 °C, 9 A, M30x1.5 Threads, Standard Duty          | <ol style="list-style-type: none"> <li>1. BK</li> <li>2. BU</li> <li>3. GN/YE</li> <li>4. BN</li> <li>5. WH</li> </ol> <p><b>Female</b></p>             |
|  | <b>RKFP 511-*M</b> | <b>RSFP 511-*M</b> | 5x18 AWG, 105 °C, 9 A, Automotive Color Code, M30x1.5 Threads  | <ol style="list-style-type: none"> <li>1. RD/WH</li> <li>2. RD/BU</li> <li>3. GN</li> <li>4. RD/OG</li> <li>5. RD/BK</li> </ol>                         |
|  | <b>RKFP 55-*M</b>  | <b>RSFP 55-*M</b>  | 5x16 AWG, 105 °C, 10 A, Automotive Color Code, M30x1.5 Threads | <p><b>Male</b></p>  |
| <p><b>RSFP ..</b></p> <p><b>RSFP Cutout</b></p> <p>Recommended maximum panel thickness is 6.4 mm</p> | <b>RKFP 61-*M</b>  | <b>RSFP 61-*M</b>  | 6x18 AWG, 105 °C, 8 A, M30x1.5 Threads, Standard Duty          | <ol style="list-style-type: none"> <li>1. GN</li> <li>2. WH</li> <li>3. BU</li> <li>4. GY</li> <li>5. YE</li> <li>6. BN</li> </ol> <p><b>Female</b></p> |
|  | <b>RKFP 66-*M</b>  | <b>RSFP 66-*M</b>  | 6x16 AWG 105 °C, 8 A, M30x1.5 Threads, Heavy Duty              | <ol style="list-style-type: none"> <li>1. WH</li> <li>2. RD</li> <li>3. GN</li> <li>4. OG</li> <li>5. BK</li> <li>6. BU</li> </ol>                      |
|  | <b>RKFP 68-*M</b>  | <b>RSFP 68-*M</b>  | 6x18 AWG 105 °C, 8 A, M30x1.5 Threads, Heavy Duty              | <p><b>Male</b></p>  |

We reserve the right to make technical alterations without prior notice.

Standard lead length is 0.3 meters. Consult factory for other lengths.

\*\* Standard housing material is nickel plated brass.. "RSFP .."; "RSFPV .." indicates stainless steel housing. To specify PVC jacketed cable, add "/S717" to the end of the part number.

PCB Pins Receptacles

- NEMA 1, 3, 4, 6P
- IEC IP67 Protection
- 600 V, 9 A



| Housing Style           | Female Part Number | Male Part Number  | Features                              | Pinout                                  |
|-------------------------|--------------------|-------------------|---------------------------------------|---|
| <p><b>RKF ..PCB</b></p> | <b>RKF 40-PCB</b>  | <b>RSF 40-PCB</b> | 4-pin PCB Pins, 105 °C, PG 11 Threads | <p><b>Female</b></p> <p><b>Male</b></p> |
| <p><b>RSF ..PCB</b></p> | <b>RKF 50-PCB</b>  | <b>RSF 50-PCB</b> | 5-pin PCB Pins, 105 °C, PG 11 Threads | <p><b>Female</b></p> <p><b>Male</b></p> |

We reserve the right to make technical alterations without prior notice.

\*\* Standard housing material is nickel plated brass. "RSFL .."; "RSFVL .." indicates stainless steel housing. No stainless option for "PCB". For locknuts to be included, add "W/LN" to the end of the part number.

Receptacles

4-pin PCB Board Layout

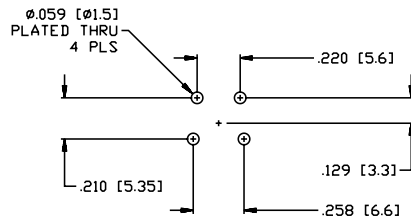

5-pin PCB Board Layout

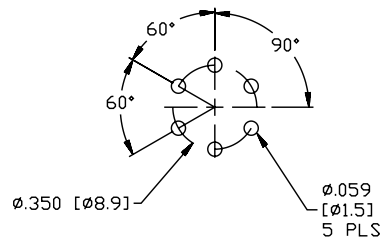

## Solder Cup Receptacles

- NEMA 1, 3, 4, 6P
- IEC IP67 Protection
- 600 V, 9 A



| Housing Style | Female Part Number | Male Part Number | Features   | Pinout                        |
|---------------|--------------------|------------------|--|-------------------------------|
|               | RKFL 26            | RSFL 26          | 2-pin solder cups,<br>105 °C, 1/2-14 NPSM<br>Threads | <b>Female/Male</b><br>        |
|               | RKFL 36            | RSFL 36          | 3-pin solder cups,<br>105 °C, 1/2-14 NPSM<br>Threads | <b>Female</b> <b>Male</b><br> |
|               | RKFL 46            | RSFL 46          | 4-pin solder cups<br>105 °C, 1/2-14 NPSM<br>Threads  | <b>Female</b> <b>Male</b><br> |
|               | RKFL 56            | RSFL 56          | 5-pin solder cups<br>105 °C, 1/2-14 NPSM<br>Threads  | <b>Female</b> <b>Male</b><br> |
|               | RKFL 66            | RSFL 66          | 6-pin solder cups<br>105 °C, 1/2-14 NPSM<br>Threads  | <b>Female</b> <b>Male</b><br> |

We reserve the right to make technical alterations without prior notice.

\*\* Standard housing material is nickel plated brass.. "RSFL .."; "RSFVL .." indicates stainless steel housing. No stainless option for "PCB".  
For locknuts to be included, add "W/LN" to the end of the part number.

4-pin PCB Board Layout

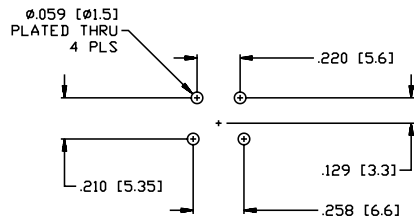

5-pin PCB Board Layout

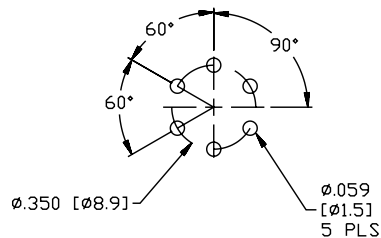



Bulkhead Feed-Thru Receptacles

- NEMA 1, 3, 4, 6P
- IEC IP67 Protection
- 600 V, 9 A



| Housing Style  | Part Number          | Features   | Pinout            |                 |
|--|----------------------|--|-------------------|-----------------|
| <p><b>Note: Recommended maximum panel thickness is 22.2 mm</b></p> | <b>RSF RKF 20/22</b> | Nickel plated brass<br>2-pin, 105 °C, thrust<br>washer and panel<br>keyway prevent<br>rotation | <b>Female</b><br> | <b>Male</b><br> |
|  | <b>RSF RKF 30/22</b> | Nickel plated brass<br>3-pin, 105 °C, thrust<br>washer and panel<br>keyway prevent<br>rotation | <b>Female</b><br> | <b>Male</b><br> |
|  | <b>RSF RKF 40/22</b> | Nickel plated brass<br>4-pin, 105 °C, thrust<br>washer and panel<br>keyway prevent<br>rotation | <b>Female</b><br> | <b>Male</b><br> |
|  | <b>RSF RKF 50/22</b> | Nickel plated brass<br>5-pin, 105 °C, thrust<br>washer and panel<br>keyway prevent<br>rotation | <b>Female</b><br> | <b>Male</b><br> |
|  | <b>RSF RKF 60/22</b> | Nickel plated brass<br>6-pin, 105 °C, thrust<br>washer and panel<br>keyway prevent<br>rotation | <b>Female</b><br> | <b>Male</b><br> |

We reserve the right to make technical alterations without prior notice.

Receptacles

\*\* Standard housing material is nickel plated brass .. "RSF RKF.."; "RSFV RKFV.." indicates stainless steel housing.

- NEMA 1, 3, 4, 6P
- IEC IP67 Protection



| Housing Style               | Female Part Number                             | Male Part Number                                 | Features  | Pinout               |
|-----------------------------|--|--|---|----------------------|
| <p><b>B 41 ..</b></p>       | <p><b>B 4131-0/9</b><br/><b>B 4231-0/9</b></p> | <p><b>BS 4131-0/9</b><br/><b>BS 4231-0/9</b></p> | <p>Glass filled nylon, PG 9 cable gland, accepts 6-8 mm cable diameter screw terminals, accepts up to 16 AWG conductors, 85 °C, 250 V, 12 A, Mates with all 3-pin cordsets and receptacles</p>      | <p><b>Female</b></p> |
| <p><b>B 4131-0/13.5</b></p> | <p><b>B 4131-0/13.5</b></p>                    | <p><b>BS 4131-0/13.5</b></p>                     | <p>Glass filled nylon, PG 13.5 cable gland, accepts 10-12 mm cable diameter screw terminals, accepts up to 16 AWG conductors, 85 °C, 250 V, 12 A, Mates with all 3-pin cordsets and receptacles</p> | <p><b>Male</b></p>   |
| <p><b>B 42 ..</b></p>       | <p><b>B 4141-0/9</b><br/><b>B 4241-0/9</b></p> | <p><b>BS 4141-0/9</b><br/><b>BS 4241-0/9</b></p> | <p>Glass filled nylon, PG 9 cable gland, accepts 6-8 mm cable diameter screw terminals, accepts up to 16 AWG conductors 85 °C, 250 V, 9 A, Mates with all 4-pin cordsets and receptacles</p>        | <p><b>Female</b></p> |
| <p><b>B 4141-0/13.5</b></p> | <p><b>B 4141-0/13.5</b></p>                    | <p><b>BS 4141-0/13.5</b></p>                     | <p>Glass filled nylon, PG 13.5 cable gland, accepts 10-12 mm cable diameter screw terminals, accepts up to 16 AWG conductors, 85 °C, 250 V, 9 A, Mates with all 4-pin cordsets and receptacles</p>  | <p><b>Male</b></p>   |
| <p><b>BS 41 ..</b></p>      | <p><b>B 4151-0/9</b><br/><b>B 4251-0/9</b></p> | <p><b>BS 4151-0/9</b><br/><b>BS 4251-0/9</b></p> | <p>Glass filled nylon, PG 9 cable gland, accepts 6-8 mm cable diameter, screw terminals, accepts up to 16 AWG conductors, 85 °C, 250 V, 9 A, Mates with all 5-pin cordsets and receptacles</p>      | <p><b>Female</b></p> |
| <p><b>B 4151-0/13.5</b></p> | <p><b>B 4151-0/13.5</b></p>                    | <p><b>BS 4151-0/13.5</b></p>                     | <p>Glass filled nylon, PG 13.5 cable gland, accepts 10-12 mm cable diameter screw terminals, accepts up to 16 AWG conductors, 85 °C, 250 V, 9 A</p>   | <p><b>Male</b></p>   |
| <p><b>BS 42 ..</b></p>      | <p><b>B 4151-0/16</b></p>                      | <p><b>BS 4151-0/16</b></p>                       | <p>Glass filled nylon, PG 16 cable gland, accepts 12-14 mm cable diameter screw terminals, accepts up to 16 AWG conductors, 85 °C, 250 V, 9 A</p>   | <p><b>Male</b></p>   |

We reserve the right to make technical alterations without prior notice.

6, 7 and 8-Pin Field Wireable Connectors

- IEC IP67 Protection



We reserve the right to make technical alterations without prior notice.

| Housing Style         | Female Part Number   | Male Part Number      | Features  | Pinout                                  |
|-----------------------|----------------------|-----------------------|---|---|
| <p><b>B 71..</b></p>  | <b>B 716B61-0/21</b> | <b>BS 716B61-0/21</b> | Glass filled nylon, PG 21 cable gland, accepts 9-16 mm cable diameter, Screw terminal, accepts 14-18 AWG conductors, 105 °C, 600 VAC/VDC, 8 A, Mates with all B-size 6-pin cordsets and receptacles | <p><b>Female</b></p> <p><b>Male</b></p> |
|                       | <b>B 7171-0/21</b>   | <b>BS 7171-0/21</b>   | Glass filled nylon, PG 21 cable gland, accepts 9-16 mm cable diameter, Screw terminal, accepts 14-18 AWG conductors, 105 °C, 600 VAC/VDC, 8 A, Mates with all 7-pin cordsets and receptacles        | <p><b>Female</b></p> <p><b>Male</b></p> |
| <p><b>BS 71..</b></p> | <b>B 7181-0/21</b>   | <b>BS 7181-0/21</b>   | Glass filled nylon, PG 21 cable gland, accepts 9-16 mm cable diameter, Screw terminal, accepts 14-18 AWG conductors, 105 °C, 600 VAC/VDC, 8 A, Mates with all 8-pin cordsets and receptacles        | <p><b>Female</b></p> <p><b>Male</b></p> |

Receptacles

- IEC IP67 Protection



| Housing Style         | Female Part Number  | Male Part Number     | Features  | Pinout                                  |
|-----------------------|---------------------|----------------------|---|---|
| <p><b>B 71..</b></p>  | <b>B 7191-0/21</b>  | <b>BS 7191-0/21</b>  | Glass filled nylon, PG 21 cable gland, accepts 13 to 18 mm cable diameter, Screw terminal, accepts 14 to 18 AWG conductors, 105 °C, 600 VAC/VDC, 7 Amps, Mates with all 9-pin cordsets and receptacles  | <p><b>Female</b></p> <p><b>Male</b></p> |
|                       | <b>B 71101-0/21</b> | <b>BS 71101-0/21</b> | Glass filled nylon, PG 21 cable gland, accepts 13 to 18 mm cable diameter, Screw terminal, accepts 14 to 18 AWG conductors, 105 °C, 600 VAC/VDC, 7 Amps, Mates with all 10-pin cordsets and receptacles | <p><b>Female</b></p> <p><b>Male</b></p> |
| <p><b>BS 71..</b></p> | <b>B 71121-0/21</b> | <b>BS 71121-0/21</b> | Glass filled nylon, PG 21 cable gland, accepts 13 to 18 mm cable diameter, Screw terminal, accepts 14 to 18 AWG conductors, 105 °C, 600 VAC/VDC, 7 Amps, Mates with all 12-pin cordsets and receptacles | <p><b>Female</b></p> <p><b>Male</b></p> |

We reserve the right to make technical alterations without prior notice.

## Conduit Adapters, 1 Port

- Attaches to standard Crouse-Hinds 3/4" Form 8, Mark 9 Conduit Bodies for transition to 3-5 Wire Minifast Connectors
- Gasket and 8-32 x 1/2 Mounting Screws
- IP67 Protection (only when all receptacles are mated or covered with plugs)
- Terminal Strips accept up to 12 AWG Wires



We reserve the right to make technical alterations without prior notice.

| Housing Style | Part Number | Features   | Pinout                                  | Wiring Diagram |
|---------------|-------------|--|---|----------------|
|               | CA-1/RKF 30 | Nylon housing 80 °C, 250 V, 9 A, attaches to standard conduit body for transition to 3-wire Minifast connector | <p><b>Female</b></p> <p><b>Male</b></p> |                |
|               | CA-1/RKF 40 | Nylon housing 80 °C, 250 V, 9 A, attaches to standard conduit body for transition to 4-wire Minifast connector | <p><b>Female</b></p> <p><b>Male</b></p> |                |
|               | CA-1/RKF 50 | Nylon housing 80 °C, 250 V, 9 A, attaches to standard conduit body for transition to 5-wire Minifast connector | <p><b>Female</b></p> <p><b>Male</b></p> |                |

\*\* Standard receptacle housing material is nickel plated brass..“RKF”; “RKFV” indicates stainless steel. Example: CA-2/RKFV 50.

Field Wireables

- Attaches to standard Crouse-Hinds 3/4" Form 8, Mark 9 Conduit Bodies for transition to 3-5 Wire Minifast Connectors
- Gasket and 8-32 x 1/2 Mounting Screws
- IP67 Protection (only when all receptacles are mated or covered with plugs)
- Terminal Strips accept up to 12 AWG Wires



| Housing Style | Part Number      | Features  | Pinout               | Wiring Diagram |
|---------------|------------------|---|----------------------|----------------|
|               | CA-2/RKF 30      | Nylon housing, 80 °C, 250 V, 9 A, attaches to standard conduit body for transition to 3-wire Minifast connector                 | <p><b>Female</b></p> |                |
|               | CA-2/RKF 30/S651 | Nylon housing, 80 °C, 250 V, 9 A, attaches to standard conduit body for transition to 3-wire Minifast connector, parallel wired | <p><b>Male</b></p>   |                |
|               | CA-2/RKF 40      | Nylon housing, 80 °C, 250 V, 9 A, attaches to standard conduit body for transition to 4-wire Minifast connector                 | <p><b>Female</b></p> |                |
|               | CA-2/RKF 40/S651 | Nylon housing, 80 °C, 250 V, 9 A, attaches to standard conduit body for transition to 4-wire Minifast connector, parallel wired | <p><b>Male</b></p>   |                |
|               | CA-2/RKF 50      | Nylon housing, 80 °C, 250 V, 9 A, attaches to standard conduit body for transition to 5-wire Minifast connector                 | <p><b>Female</b></p> |                |
|               | CA-2/RKF 50/S651 | Nylon housing, 80 °C, 250 V, 9 A, attaches to standard conduit body for transition to 5-wire Minifast connector, parallel wired | <p><b>Male</b></p>   |                |

We reserve the right to make technical alterations without prior notice.

\*\* Standard receptacle housing material is nickel plated brass.. "RKF"; "RKFV" indicates stainless steel. Example: CA-2/RKFV 50.

Tees

- Available with Parallel or Junction-style wiring
- Simplifies Wiring Installations
- Tough Molded TPU Body



We reserve the right to make technical alterations without prior notice.

| Connector Style | Part Number           | Features  | Pinout |
|-----------------|-----------------------|---|--------|
|                 | <b>RSM-2RKM 20</b>    | 1 male and 2 female connectors, 250 V, 9 A, 80 °C, parallel wired, 2 conductor                      |        |
|                 | <b>RSM-2RKM 30</b>    | 1 male and 2 female connectors, 250 V, 9 A, 80 °C, parallel wired, 3 conductor                      |        |
|                 | <b>RSM-2RKM 40</b>    | 1 male and 2 female connectors, 250 V, 9 A, 80 °C, parallel wired, 4 conductor                      |        |
|                 | <b>RSM-2RKM 50</b>    | 1 male and 2 female connectors, 250 V, 9 A, 80 °C, parallel wired, 5 conductor                      |        |
|                 | <b>RSM 50-2RKM 30</b> | 1 male 5-pin connector, 2 female 3-pin connectors, 250 V, 9.0 A, 80 °C, combine two cables into one |        |

Tees

Pinouts

| Female       |              |              |              | Male         |              |              |              |
|--------------|--------------|--------------|--------------|--------------|--------------|--------------|--------------|
|              |              |              |              |              |              |              |              |
| <b>2-Pin</b> | <b>3-Pin</b> | <b>4-Pin</b> | <b>5-Pin</b> | <b>2-Pin</b> | <b>3-Pin</b> | <b>4-Pin</b> | <b>5-Pin</b> |

## Tees

- Drop Keyway Facing Male or Female Connector
- Available with Parallel Wiring
- Simplifies Wiring Installations
- Tough Molded TPU Body



| Connector Style              | Part Number           | Features  | Pinout |
|------------------------------|-----------------------|---|--------|
| <p><b>RSM-2RKM ..-KM</b></p> | <b>RSM-2RKM 30-KM</b> | 1 male and 2 female connectors, 250 V, 9 A, 80 °C Parallel wired, 3 conductor, keyway facing male connector   |        |
| <p><b>RSM-2RKM 40 KM</b></p> | <b>RSM-2RKM 40 KM</b> | 1 male and 2 female connectors, 250 V, 9 A, 80 °C Parallel wired, 4 conductor, keyway facing male connector   |        |
| <p><b>RSM-2RKM ..-KF</b></p> | <b>RSM-2RKM 30-KF</b> | 1 male and 2 female connectors, 250 V, 9 A, 80 °C Parallel wired, 3 conductor, keyway facing female connector |        |
| <p><b>RSM-2RKM 40-KF</b></p> | <b>RSM-2RKM 40-KF</b> | 1 male and 2 female connectors, 250 V, 9 A, 80 °C Parallel wired, 4 conductor, keyway facing female connector |        |

We reserve the right to make technical alterations without prior notice.

### Pinouts

| Female       |              | Male         |              |
|--------------|--------------|--------------|--------------|
|              |              |              |              |
| <b>3-Pin</b> | <b>4-Pin</b> | <b>3-Pin</b> | <b>4-Pin</b> |



## Junction Tees, Cable on Female Branches

- Junction-style Wiring
- Simplifies Wiring Installations
- Tough Molded TPU Body

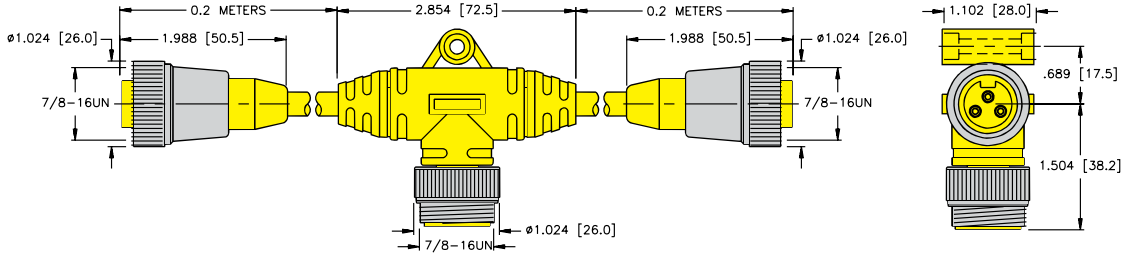

We reserve the right to make technical alterations without prior notice.

| Connector Style | Part Number                 | Features   | Pinout |
|-----------------|-----------------------------|--|--------|
| See above       | RKM 30-*-RSM 50-RKM 30-*    | Two 3-pin female cordsets, PVC Yellow, 3x18 AWG, 7.3 mm OD, one 5-pin male connector, 250 V, 9 A, 80 °C, combine two cables into one               |        |
|                 | RKM 40-*-RSM 40-RKM 40-*    | Two 4-pin female cordsets, PVC Yellow, 4x18 AWG, 7.3 mm OD, one 4-pin male connector, 250 V, 9 A, 80 °C, parallel wired                            |        |
|                 | RKM 301-*-RSM 301-RKM 301-* | Two 3-pin female cordsets, PVC Yellow, 3x18 AWG, 7.3 mm OD, one 3-pin male connector, 250 V, 9 A, 80 °C, combine two cables into one, series wired |        |

\* Length in meters.  
Standard coupling nut material is nickel plated brass .. "RSM or RKM"; "RS or RK" indicates nylon and "RSV or RKV" indicates stainless steel.

### Pinouts

| Female |       |       | Male  |       |       |
|--------|-------|-------|-------|-------|-------|
|        |       |       |       |       |       |
| 3-Pin  | 4-Pin | 5-Pin | 3-Pin | 4-Pin | 5-Pin |

## Junction Tees, Cable on Male Trunk

- Junction-style Wiring
- Simplifies Wiring Installations
- Tough Molded TPU Body

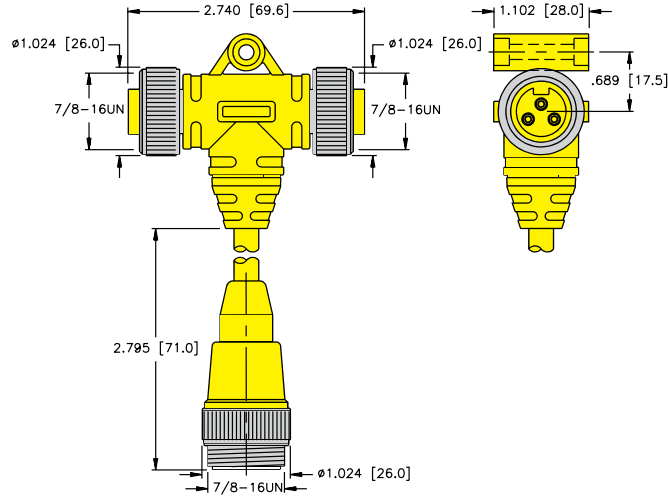

| Connector Style | Part Number                         | Features   | Pinout |
|-----------------|-------------------------------------|--|--------|
| See above       | RKM 30-* <i>-RSM 50-RKM 30-*</i>    | Two 3-pin female cordsets, PVC Yellow, 3x18 AWG, 7.3 mm O.D., one 5-pin male connector, 250 V, 9 A, 80 °C, combine two cables into one             |        |
|                 | RKM 40-* <i>-RSM 40-RKM 40-*</i>    | Two 4-pin female cordsets, PVC Yellow, 4x18 AWG, 7.3 mm OD, one 4-pin male connector, 250 V, 9 A, 80 °C, parallel wired                            |        |
|                 | RKM 301-* <i>-RSM 301-RKM 301-*</i> | Two 3-pin female cordsets, PVC Yellow, 3x18 AWG, 7.3 mm OD, one 3-pin male connector, 250 V, 9 A, 80 °C, combine two cables into one, series wired |        |

We reserve the right to make technical alterations without prior notice.

\* Length in meters.  
Standard coupling nut material is nickel plated brass .. "RSM or RKM"; "RS or RK" indicates nylon and "RSV or RKV" indicates stainless steel.

### Pinouts

| Female |       | Male  |       |
|--------|-------|-------|-------|
|        |       |       |       |
| 3-Pin  | 4-Pin | 3-Pin | 4-Pin |

**h-Style Tees**

- Parallel Wiring
- Simplifies Wiring Installations
- Tough Molded TPU Black Body
- NEMA 1, 3, 4, 6P
- IEC IP67 Protection



We reserve the right to make technical alterations without prior notice.

Tees

| Connector Style | Part Number            | Features  | Wiring Diagram |
|-----------------|------------------------|---|----------------|
|                 | <b>XSH-RSM-2RKM 20</b> | 1 male and 2 female connectors, 600 V, 9 A, 105 °C, parallel wired, 2 conductor |                |
|                 | <b>XSH-RSM-2RKM 30</b> | 1 male and 2 female connectors, 600 V, 9 A, 105 °C, parallel wired, 3 conductor |                |
|                 | <b>XSH-RSM-2RKM 40</b> | 1 male and 2 female connectors, 600 V, 9 A, 105 °C, parallel wired, 4 conductor |                |
|                 | <b>XSH-RSM-2RKM 50</b> | 1 male and 2 female connectors, 600 V, 9 A, 105 °C, parallel wired, 5 conductor |                |
|                 | <b>XSH-RSM-2RKM 60</b> | 1 male and 2 female connectors, 600 V, 9 A, 105 °C, parallel wired, 6 conductor |                |

**Pinouts**

| Female       |              |              |              |              | Male         |              |              |              |              |
|--------------|--------------|--------------|--------------|--------------|--------------|--------------|--------------|--------------|--------------|
|              |              |              |              |              |              |              |              |              |              |
| <b>2-Pin</b> | <b>3-Pin</b> | <b>4-Pin</b> | <b>5-Pin</b> | <b>6-Pin</b> | <b>2-Pin</b> | <b>3-Pin</b> | <b>4-Pin</b> | <b>5-Pin</b> | <b>6-Pin</b> |

## Quick Disconnect Adapters

- Adapt to Standard Minifast
- Cordsets
- Available w/NPSM or PG 9 Threads



| Housing Style                 | Part Number          | Features   | Pinout                                    |
|-------------------------------|----------------------|--|---|
| <p><b>B11... or B21..</b></p> | <b>B2131-*M</b>      | Nylon, 300 V, 4 A, 3x22 AWG, 70 °C, mates with 3-pin cordsets, 1/2-14 NPSM Threads               | 1. Gn<br>2. Bn<br>3. Bu                   |
|                               | <b>B1131-*M</b>      | Nickel plated brass, 300 V, 4 A, 3x22 AWG, 70 °C, mates with 3-pin cordsets, 1/2-14 NPSM Threads | 1. Bk<br>2. Bn<br>3. Bu                   |
|                               | <b>B2131-*M/S523</b> | Nylon, 300 V, 4 A, 3x22 AWG, 70 °C, mates with 3-pin cordsets, 1/2-14 NPSM Threads               | 1. Bn<br>2. Wh<br>3. Bu<br>4. Bk          |
|                               | <b>B2141-*M</b>      | Nylon, 300 V, 4 A, 4x22 AWG, 70 °C, mates with 4-pin cordsets, 1/2-14 NPSM Threads               | 1. Bn<br>2. Wh<br>3. Bu<br>4. Bk          |
|                               | <b>B1141-*M</b>      | Nickel plated brass, 300 V, 4 A, 4x22 AWG, 70 °C, mates with 4-pin cordsets, 1/2-14 NPSM Threads | 1. Bn<br>2. Wh<br>3. Bu<br>4. Bk          |
| <p><b>B11..PG9-*M</b></p>     | <b>B1131-PG9-*M</b>  | Nickel plated brass, 300 V, 4 A, 3x22 AWG, 70 °C, mates with 3-pin cordsets, PG 9 Threads        | 1. Gn<br>2. Bn<br>3. Bu                   |
|                               | <b>B1141-PG9-*M</b>  | Nickel plated brass, 300 V, 4 A, 4x22 AWG, 70 °C, mates with 4-pin cordsets, PG 9 Threads        | 1. Bn<br>2. Wh<br>3. Bu<br>4. Bk          |
|                               | <b>B1151-PG9-*M</b>  | Nickel plated brass, 300 V, 4 A, 5x22 AWG, 70 °C, mates with 5-pin cordsets, PG 9 Threads        | 1. Bn<br>2. Wh<br>3. Bu<br>4. Bk<br>5. Gn |

We reserve the right to make technical alterations without prior notice.

## Quick Disconnect Adapters

- Convert Minifast to Eurofast® or Microfast®
- Rugged Metal Connector



| Housing Style | Part Number          | Features   | Wiring Diagram |
|---------------|----------------------|--|----------------|
|               | <b>RSM 40-FK 4.4</b> | Nickel plated brass, 250 V, 4 A, 80 °C, female Eurofast, male Minifast, 4-pin  |                |
|               | <b>RSM 50-FK 4.5</b> | Nickel plated brass, 250 V, 4 A, 80 °C, female Eurofast, male Minifast, 5-pin  |                |
|               | <b>RKM 30/SB3</b>    | Nickel plated brass, 250 V, 4 A, 80 °C, female Minifast, male Microfast, 3-pin |                |

We reserve the right to make technical alterations without prior notice.

Accessories

### Pinouts

| Female       |              |              | Male         |              |              |
|--------------|--------------|--------------|--------------|--------------|--------------|
|              |              |              |              |              |              |
| <b>3-Pin</b> | <b>4-Pin</b> | <b>5-Pin</b> | <b>3-Pin</b> | <b>4-Pin</b> | <b>5-Pin</b> |

## Closure Caps, A-Size

- 7/8-16 UN Threads
- Nickel Plated Brass and Stainless Steel
- Male and Female Caps



| Closure Cap Style | Part Number    | Features   |
|-------------------|----------------|--|
|                   | <b>RKM-CC</b>  | Nickel plated brass, 7/8-16 UN threads, 6" stainless steel lanyard, closure cap, mates to male cordsets, receptacles   |
|                   | <b>RKMV-CC</b> | Stainless steel, 7/8-16 UN threads, 6" stainless steel lanyard, closure cap, mates to male cordsets, receptacles       |
|                   | <b>RSM-CC</b>  | Nickel plated brass, 7/8-16 UN threads, 6" stainless steel lanyard, closure cap, mates to female cordsets, receptacles |
|                   | <b>RSMV-CC</b> | Stainless steel, 7/8-16 UN threads, 6" stainless steel lanyard, closure cap, mates to female cordsets, receptacles     |
|                   | <b>RKF-CC</b>  | Nickel plated brass, 7/8-16 UN threads, 6" stainless steel lanyard, Closure cap, mates to male cordsets, receptacles   |
|                   | <b>RKFV-CC</b> | Stainless steel, 7/8-16 UN threads, 6" stainless steel lanyard, closure cap, mates to male cordsets, receptacles       |
|                   | <b>RSF-CC</b>  | Nickel plated brass, 7/8-16 UN threads, 6" stainless steel lanyard, closure cap, mates to female cordsets, receptacles |
|                   | <b>RSFV-CC</b> | Stainless steel, 7/8-16 UN threads, 6" stainless steel lanyard, closure cap, mates to female cordsets, receptacles     |
|                   | <b>RKF-MC</b>  | Nickel plated brass, 7/8-16 UN threads, BUNA-N gasket, closure cap, mates to male cordsets, receptacles                |
|                   | <b>RKFV-MC</b> | Stainless steel, 7/8-16 UN threads, BUNA-N gasket, closure cap, mates to male cordsets, receptacles                    |
|                   | <b>RSF-MC</b>  | Nickel plated brass, 7/8-16 UN threads, BUNA-N gasket and O-ring, closure cap, mates to female cordsets, receptacles   |
|                   | <b>RSFV-MC</b> | Stainless steel, 7/8-16 UN threads, BUNA-N gasket and O-ring, closure cap, mates to female cordsets, receptacles       |

We reserve the right to make technical alterations without prior notice.

Note: Add "/S1599" to the end of Part Number for closure caps assembled on cordsets.



## Closure Caps, B-Size

- 1-16 UN Threads
- Nickel Plated Brass and Stainless Steel
- Male and Female Caps



| Closure Cap Style | Part Number     | Features   |
|-------------------|-----------------|--|
|                   | <b>RKMB-CC</b>  | Nickel plated brass, 1-16 UN threads, 6" stainless steel lanyard, closure cap, mates to male cordsets      |
|                   | <b>RKMBV-CC</b> | Stainless steel, 1-16 UN threads 6" stainless steel lanyard, closure cap, mates to male cordsets           |
|                   | <b>RSMB-CC</b>  | Nickel plated brass, 1-16 UN threads, 6" stainless steel lanyard, closure cap, mates to female cordsets    |
|                   | <b>RSMBV-CC</b> | Stainless steel, 1-16 UN threads, 6" stainless steel lanyard, closure cap, mates to female cordsets        |
|                   | <b>RKFB-CC</b>  | Nickel plated brass, 1-16 UN threads, 6" stainless steel lanyard, Closure cap, mates to male receptacles   |
|                   | <b>RKFBV-CC</b> | Stainless steel, 1-16 UN threads, 6" stainless steel lanyard, Closure cap, mates to male receptacles       |
|                   | <b>RSFB-CC</b>  | Nickel plated brass, 1-16 UN threads, 6" stainless steel lanyard, closure cap, mates to female receptacles |
|                   | <b>RSFBV-CC</b> | Stainless steel, 1-16 UN threads, 6" stainless steel lanyard, closure cap, mates to female receptacles     |
|                   | <b>RKFB-MC</b>  | Nickel plated brass, 1-16 UN threads, BUNA-N gasket and O-ring, closure cap, mates to male receptacles     |
|                   | <b>RKFBV-MC</b> | Stainless steel, 1-16 UN threads, BUNA-N gasket and O-ring, closure cap, mates to male receptacles         |
|                   | <b>RSFB-MC</b>  | Nickel plated brass, 1-16 UN threads, BUNA-N gasket and O-ring, closure cap, mates to female receptacles   |
|                   | <b>RSFBV-MC</b> | Stainless steel, 1-16 UN threads, BUNA-N gasket and O-ring, closure cap, mates to female receptacles       |

We reserve the right to make technical alterations without prior notice.

Note: Add "/S1599" to the end of Part Number for closure caps assembled on cordsets.



Accessories

## Closure Caps, C-Size

- 1 1/8-16 UN Threads
- Nickel Plated Brass and Stainless Steel
- Male and Female Caps



| Closure Cap Style | Part Number     | Features  |
|-------------------|-----------------|---|
|                   | <b>RKMC-CC</b>  | Nickel plated brass, 11/8-16 UN threads, 6" stainless steel lanyard, closure cap, mates to male cordsets      |
|                   | <b>RKMCV-CC</b> | Stainless steel, 11/8-16 UN threads, 6" stainless steel lanyard, closure cap, mates to male cordsets          |
|                   | <b>RSMC-CC</b>  | Nickel plated brass, 11/8-16 UN threads, 6" stainless steel lanyard, closure cap, mates to female cordsets    |
|                   | <b>RSMCV-CC</b> | Stainless steel, 11/8-16 UN threads, 6" stainless steel lanyard, closure cap, mates to female cordsets        |
|                   | <b>RKFC-CC</b>  | Nickel plated brass, 11/8-16 UN threads, 6" stainless steel lanyard, closure cap, mates to male receptacles   |
|                   | <b>RKFCV-CC</b> | Stainless steel, 11/8-16 UN threads, 6" stainless steel lanyard, closure cap, mates to male receptacles       |
|                   | <b>RSFC-CC</b>  | Nickel plated brass, 11/8-16 UN threads, 6" stainless steel lanyard, closure cap, mates to female receptacles |
|                   | <b>RSFCV-CC</b> | Stainless steel, 11/8-16 UN threads, 6" stainless steel lanyard, closure cap, mates to female receptacles     |
|                   | <b>RKFC-MC</b>  | Nickel plated brass, 11/8-16 UN threads, BUNA-N gasket and O-ring, closure cap, mates to male receptacles     |
|                   | <b>RKFCV-MC</b> | Stainless steel, 11/8-16 UN threads, BUNA-N gasket and O-ring, closure cap, mates to male receptacles         |
|                   | <b>RSFC-MC</b>  | Nickel plated brass, 11/8-16 UN threads, BUNA-N gasket and O-ring, closure cap, mates to female receptacles   |
|                   | <b>RSFCV-MC</b> | Stainless steel, 11/8-16 UN threads, BUNA-N gasket and O-ring, closure cap, mates to female receptacles       |

We reserve the right to make technical alterations without prior notice.

Note: Add "/S1599" to the end of Part Number for closure caps assembled on cordsets.



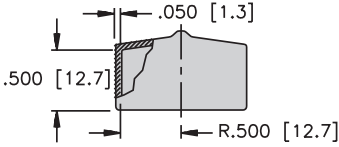
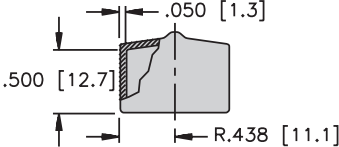
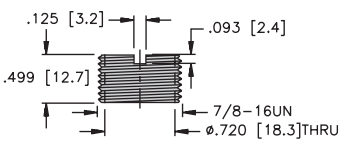
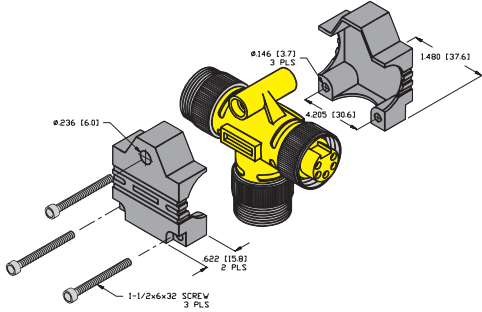

| Housing Style   | Part Number                             | Features  |
|---|---|---|
|    | <p><b>DUST CAP RKM (50/PACKAGE)</b></p> | <p>Nylon, closure cap, mates to junction boxes and female cordsets</p>          |
|    | <p><b>DUST CAP RSM (50/PACKAGE)</b></p> | <p>Nylon, closure cap, mates to junction boxes and male cordsets</p>            |
|    | <p><b>FF 78 AL</b></p>                  | <p>Anodized Aluminum, female adapter to be used with 2 female coupling nuts</p> |
|  | <p><b>MB-MINITEE 1</b></p>              | <p>Nylon, mounting bracket for Minifast tees</p>                                |

We reserve the right to make technical alterations without prior notice.



|                         |            |
|-------------------------|------------|
| <b>Part Number Keys</b> | <b>G2</b>  |
| <b>Cordsets</b>         | <b>G4</b>  |
| <b>Receptacles</b>      | <b>G9</b>  |
| <b>Field Wireables</b>  | <b>G27</b> |
| <b>Closure Caps</b>     | <b>G30</b> |

**Features**

- M16 threaded connectors
- 5 through 8, 12, 14 and 19-pin
- Up to 8 Amp, 300 Volt rated
- Multiple tee configurations
- IEC IP67 protection
- Signal consolidation



## Cordset Part Number Key

Part Number Keys are to assist in IDENTIFICATION ONLY. Consult factory for catalog items not identified.

|          |          |          |           |            |          |             |
|----------|----------|----------|-----------|------------|----------|-------------|
| <b>B</b> | <b>S</b> | <b>M</b> | <b>12</b> | <b>999</b> | <b>*</b> | <b>/S..</b> |
|----------|----------|----------|-----------|------------|----------|-------------|

**M16 Versafast Cordset**

**Gender**  
 K = female connector  
 S = male connector

**Configuration**  
 (blank) = assembled connector  
 M = straight molded  
 WM = right angle molded

**Housing Material**  
 (blank) = nickel plated brass  
 K = nylon  
 V = stainless steel

**Insertion Point of Extension Cable and Second Prefix\***  
 \* Male connector listed first, female connector second  
 Example: **BSM BKM 12-001-1**

**Number of Pins**

|       |         |
|-------|---------|
| 5 = 5 | 12 = 12 |
| 6 = 6 | 14 = 14 |
| 7 = 7 | 19 = 19 |
| 8 = 8 |         |

**Varieties**  
 (blank) = PVC jacket  
 /S90 = TPU jacket  
 /S101 = Flexlife®-20, high flex cable

**Length in Meters**

**Number of Wires / AWG / Color Codes**

|               |           |  |
|---------------|-----------|--|
| <u>5-Pin</u>  |           |  |
| 084 =         | 5x18 AWG  | BN, BU, WH, BU, BK, GY   |
| <u>6-Pin</u>  |           |  |
| 085 =         | 6x18 AWG  | BN, BU, WH, BU, BK, GY, PK   |
| <u>7-Pin</u>  |           |  |
| 086 =         | 7x18 AWG  | WH, BN, GN, YE, GY, PK, BU   |
| <u>8-Pin</u>  |           |  |
| 087 =         | 8x18 AWG  | WH, BN, GN, YE, GY, PK, BU, RD   |
| <u>12-Pin</u> |           |  |
| 001 =         | 12x22 AWG | BN, BU, WH, GN, YE, GY, PK, RD, BK, OG, TN, VT / TPU jacket  |
| 967 =         | 12x22 AWG | (same color code as 001) / PVC jacket  |
| 999 =         | 12x22 AWG | (same color code as 001) / TPE jacket  |
| <u>14-Pin</u> |           |  |
| 000 =         | 14x22 AWG | BN, RD/BU, BK, PK, GN, BU, OG, GY/BN, VT, WH, RD, GY, YE, TN / TPE jacket                                    |
| 002 =         | 14x22 AWG | (same color code as 000) / TPU jacket  |
| 755 =         | 12x24 AWG | OG, BK, GN, GY, BN, TN, VT, RD, WH, YE, PK, BU / PVC jacket  |
| 836 =         | 10x24 AWG | GY, GN, BK, BN, PK, YE, WH, RD, VT, BU / PVC jacket  |
| 917 =         | 12x24 AWG | RD/BU, GY, GN, BK, GY/PK, BN, PK, YE, WH, RD, VT, BU / PVC jacket  |
| 954 =         | 10x24 AWG | (same color code as 836) / TPE jacket  |
| 998 =         | 14x22 AWG | (same color code as 000) / PVC jacket  |
| <u>19-Pin</u> |           |  |
| 995 =         | 19x22 AWG | BU, GY/PK, RD/BU, WH/GN, BK, BN/GN, PK, WH/YE, GN, YE/BN, BU, OG, GY/BN, VT, WH, RD, GY, YE, TN / PVC jacket |
| 996 =         | 19x22 AWG | (same color code as 995) / TPU jacket  |
| 997 =         | 19x22 AWG | (same color code as 995) / TPE jacket  |

### Extension Examples

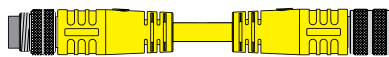

**B S M**    **B K W**    **12** - **999** - **\*** /S..

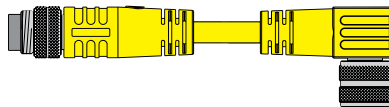

**B S M**    **B K W M**    **12** - **999** - **\*** /S..

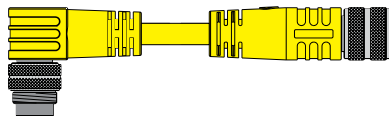

**B S W M**    **B K M**    **12** - **999** - **\*** /S..

## Receptacle Part Number Key

Part Number Keys are to assist in IDENTIFICATION ONLY. Consult factory for catalog items not identified.

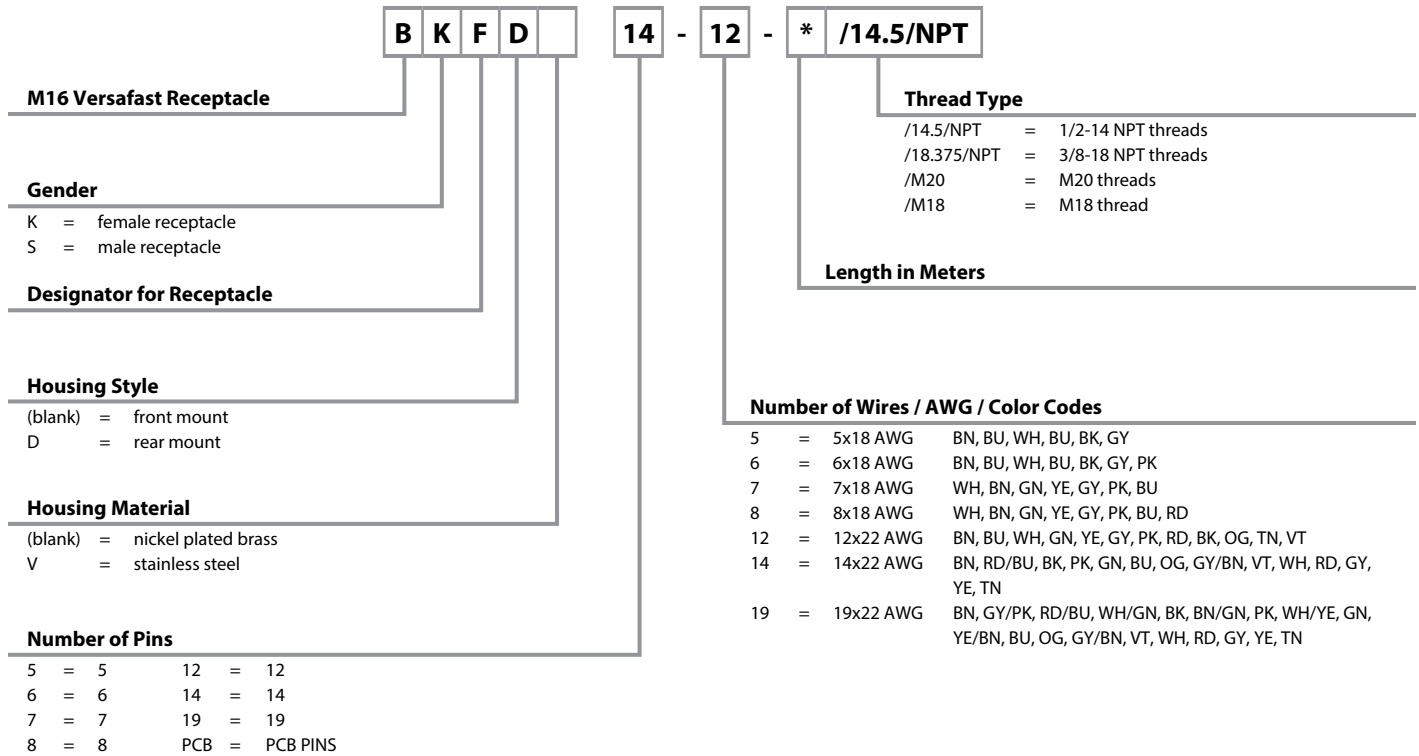

versafast®

## 5 - 8 Pin Cordsets

• IEC IP67 Protection



| Connector Style       | Female Part Number                                | Male Part Number                                  | Features  | Pinout   |
|-----------------------|---|---|---|--|
| <p><b>BKM ..</b></p>  | <p><b>BKM 5-084-*</b><br/><b>BKWM 5-084-*</b></p> | <p><b>BSM 5-084-*</b><br/><b>BSWM 5-084-*</b></p> | <p>ITC/PLTC PVC Yellow,<br/>5x18 AWG, 105 °C, 300<br/>VAC/VDC, 8 A, 7.6 mm<br/>OD, Cable #RF51084-*,M,<br/>5-wire DC application,<br/>Flexlife®</p> | <p>1. BN<br/>2. WH<br/>3. BU<br/>4. BK<br/>5. GY</p> <p><b>Female</b></p> <p><b>Male</b></p>                               |
| <p><b>BKWM ..</b></p> | <p><b>BKM 6-085-*</b><br/><b>BKWM 6-085-*</b></p> | <p><b>BSM 6-085-*</b><br/><b>BSWM 6-085-*</b></p> | <p>ITC/PLTC PVC Yellow,<br/>6x18 AWG, 105 °C, 300<br/>VAC/VDC, 7 A, 8.4 mm<br/>OD, Cable #RF51085-*,M,<br/>6-wire DC application,<br/>Flexlife</p>  | <p>1. BN<br/>2. WH<br/>3. BU<br/>4. BK<br/>5. GY<br/>6. PK</p> <p><b>Female</b></p> <p><b>Male</b></p>                     |
| <p><b>BSM ..</b></p>  | <p><b>BKM 7-086-*</b><br/><b>BKWM 7-086-*</b></p> | <p><b>BSM 7-086-*</b><br/><b>BSWM 7-086-*</b></p> | <p>ITC/ PLTC PVC Yellow,<br/>7x18 AWG, 105 °C, 125<br/>VAC/VDC, 7 A, 8.1 mm<br/>OD, Cable #RF51086-*,M,<br/>7-wire DC application,<br/>Flexlife</p> | <p>1. WH<br/>2. BN<br/>3. GN<br/>4. YE<br/>5. GY<br/>6. PK<br/>7. BU</p> <p><b>Female</b></p> <p><b>Male</b></p>           |
| <p><b>BSWM ..</b></p> | <p><b>BKM 8-087-*</b><br/><b>BKWM 8-087-*</b></p> | <p><b>BSM 8-087-*</b><br/><b>BSWM 8-087-*</b></p> | <p>ITC/PLTC PVC Yellow,<br/>8x18 AWG, 105 °C, 125<br/>VAC/VDC, 7 A, 8.9 mm<br/>OD, Cable #RF51087-*,M,<br/>8-wire DC application,<br/>Flexlife</p>  | <p>1. WH<br/>2. BN<br/>3. GN<br/>4. YE<br/>5. GY<br/>6. PK<br/>7. BU<br/>8. RD</p> <p><b>Female</b></p> <p><b>Male</b></p> |

We reserve the right to make technical alterations without prior notice.

\* Length in meters. Standard cable lengths are 5 and 10 meters. Consult factory for other lengths.  
Standard housing and coupling nut material is anodized aluminum.. "BKM.."; "BKWM.." indicates stainless steel and "BKMK.." indicates nylon.

## 12-Pin Cordsets

- For Eurofast® Junction Boxes and multi-conductor applications
- IEC IP67 Protection



| Connector Style       | Female Part Number                                    | Male Part Number                                      | Features   | Pinout                                  |
|-----------------------|---|---|--|---|
| <p><b>BKM ..</b></p>  | <b>BKM 12-001-*</b><br><b>BKWM 12-001-*</b>           | <b>BSM 12-001-*</b><br><b>BSWM 12-001-*</b>           | AWM TPU Black, 12x22 AWG, 90 °C, 125 VAC/VDC, 4 A, 7.6 mm OD, Cable #RF51001-*M, 12-wire DC applications, Flexlife®  | <p><b>Female</b></p> <p><b>Male</b></p> |
| <p><b>BKWM ..</b></p> | <b>BKM 12-967-*</b><br><b>BKWM 12-967-*</b>           | <b>BSM 12-967-*</b><br><b>BSWM 12-967-*</b>           | ITC/PLTC PVC Black, 12x22 AWG, 105 °C, 125 VAC/VDC, 4 A, 7.5 mm OD, Cable #RF50967-*M, 12-wire DC applications, Flexlife                                   |   |
| <p><b>BSM ..</b></p>  |   |   |  |   |
| <p><b>BSWM ..</b></p> | <b>BKM 12-999-*/S101</b><br><b>BKWM 12-999-*/S101</b> | <b>BSM 12-999-*/S101</b><br><b>BSWM 12-999-*/S101</b> | AWM TPE Black, 12x22 AWG, 105 °C, 125 VAC/VDC, 4 A, 8.0 mm OD, Cable #RF50999-*M, 12-wire DC applications, Flexlife-20, high flex - Over 20 million cycles |   |

We reserve the right to make technical alterations without prior notice.

Cordsets

\* Length in meters. Standard cable lengths are 5 and 10 meters. Consult factory for other lengths. Standard housing and coupling nut material is anodized aluminum.. "BKM.."; "BKWM.." indicates stainless steel and "BKMK.." indicates nylon.

## 14-Pin Cordsets

- For Picofast® Junction Boxes and multi-conductor applications
- IEC IP67 Protection



| Connector Style       | Female Part Number  | Male Part Number  | Features   | Pinout               |
|-----------------------|---|---|--|----------------------|
| <p><b>BKM ..</b></p>  | <p><b>BKM 14-002-*</b><br/><b>BKWM 14-002-*</b></p>           | <p><b>BSM 14-002-*</b><br/><b>BSWM 14-002-*</b></p>           | <p>AWM TPU Black, 14x22 AWG, 90 °C, 30 VAC/VDC, 3 A, 7.6 mm OD, Cable #RF51002-*M, 14-wire DC applications, Flexlife®</p>  | <p><b>Female</b></p> |
| <p><b>BKWM ..</b></p> | <p><b>BKM 14-000-*/S101</b><br/><b>BKWM 14-000-*/S101</b></p> | <p><b>BSM 14-000-*/S101</b><br/><b>BSWM 14-000-*/S101</b></p> | <p>AWM TPE Black, 15x22 AWG, 105 °C, 30 VAC/VDC, 3 A, 9.0 mm OD, Cable #RF51000-*M, 14-wire DC applications, Flexlife-20, high flex - over 20 million cycles</p> |                      |
| <p><b>BKM ..</b></p>  | <p><b>BKM 14-998-*</b><br/><b>BKWM 14-998-*</b></p>           | <p><b>BSM 14-998-*</b><br/><b>BSWM 14-998-*</b></p>           | <p>ITC/PLTC PVC Black, 14x22 AWG, 105 °C, 30 VAC/VDC, 3 A, 7.6 mm OD, Cable #RF50998-*M, 14-wire DC applications, Flexlife</p>                                   |                      |
| <p><b>BSWM ..</b></p> | <p><b>BKM 14-755-*</b><br/><b>BKWM 14-755-*</b></p>           | <p><b>BSM 14-755-*</b><br/><b>BSWM 14-755-*</b></p>           | <p>AWM PVC Black, 12x24 AWG, 105 °C, 30 VAC/VDC, 3 A, 6.7 mm OD, Cable #RF50755-*M, 12-wire DC applications, Flexlife</p>  |                      |

We reserve the right to make technical alterations without prior notice.

\* Length in meters. Standard cable lengths are 5 and 10 meters. Consult factory for other lengths. Standard housing and coupling nut material is anodized aluminum.. "BKM.."; "BKMV.." indicates stainless steel and "BKMK.." indicates nylon.





## 14-Pin Cordsets

- For Eurofast®/Picofast® Junction Boxes and multi-conductor applications
- IEC IP67 Protection



| Connector Style       | Female Part Number                                    | Male Part Number                                      | Features  | Pinout               |
|-----------------------|---|---|---|----------------------|
| <p><b>BKM ..</b></p>  | <b>BKM 14-836-*</b><br><b>BKWM 14-836-*</b>           | <b>BSM 14-836-*</b><br><b>BSWM 14-836-*</b>           | AWM PVC Black, 10x24 AWG, 105 °C, 30 VAC/VDC, 3 A, 6.6 mm OD, Cable #RF50836-*M, 10-wire DC applications, junction box, VB 803M(Z)-BS14, Flexlife®                                      | <p><b>Female</b></p> |
| <p><b>BKWM ..</b></p> | <b>BKM 14-954-*/S101</b><br><b>BKWM 14-954-*/S101</b> | <b>BSM 14-954-*/S101</b><br><b>BSWM 14-954-*/S101</b> | AWM TPE Black, 12x24 AWG, 105 °C, 30 VAC/VDC, 3 A, 7.6 mm OD, Cable #RF-50943*M, 10-wire DC applications, junction box VB 803M(Z)-BS14, Flexlife-20, high flex - over 20 million cycles | <p><b>Female</b></p> |
| <p><b>BSM ..</b></p>  |   |   |   |                      |
| <p><b>BSWM ..</b></p> | <b>BKM 14-917-*</b><br><b>BKWM 14-917-*</b>           | <b>BSM 14-917-*</b><br><b>BSWM 14-917-*</b>           | AWM PVC Yellow, 12x24 AWG, 105 °C, 30 VAC/VDC, 3 A, 6.6 mm OD, Cable #RF50917-*M, 12-wire DC applications, junction boxes 4MBM12-5-BS14 & VB 404M(Z)-BS14, Flexlife                     | <p><b>Male</b></p>   |

We reserve the right to make technical alterations without prior notice.

Cordsets

\* Length in meters. Standard cable lengths are 5 and 10 meters. Consult factory for other lengths. Standard housing and coupling nut material is anodized aluminum.. "BKM.." ; "BKWM.." indicates stainless steel and "BKMV.." indicates nylon.

## 19-Pin Cordsets

- For Picofast® Junction Boxes and multi-conductor applications
- IEC IP67 Protection



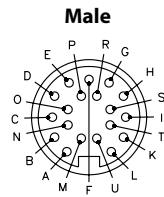
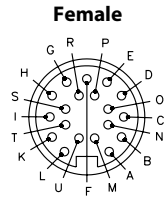

| Connector Style       | Female Part Number                          | Male Part Number                            | Features  | Pinout   |
|-----------------------|---|---|---|--|
| <p><b>BKM ..</b></p>  | <b>BKM 19-873-*</b><br><b>BKWM 19-873-*</b> | <b>BSM 19-873-*</b><br><b>BSWM 19-873-*</b> | AWM PVC Black, 19x26 AWG, 105 °C, 30 VAC/VDC, 3 A, 7.1 mm OD, Cable #RF50873-*,M, 19-wire DC applications, Flexlife®                                    | A. RD/BU<br>B. WH/GN<br>C. GY<br>D. BN/GN<br>E. GN<br>F. GN/YE<br>G. BK<br>H. WH/YE<br>I. WH/GY<br>K. GY/BN<br>L. GY/PK<br>M. BN<br>N. PK<br>O. YE<br>P. WH<br>R. RD<br>S. VT<br>T. YE/BN<br>U. BU |
| <p><b>BKWM ..</b></p> |   |   |   |  |
| <p><b>BSM ..</b></p>  | <b>BKM 19-995-*</b><br><b>BKWM 19-995-*</b> | <b>BSM 19-995-*</b><br><b>BSWM 19-995-*</b> | ITC/PLTC PVC Black, 19x22 AWG, 105 °C, 30 VAC/VDC, 3 A, 8.5 mm OD, Cable #RF50995-*,M, 19-wire DC applications & junction box VB 804M(Z)-BS19, Flexlife | A. BU<br>B. GY/PK<br>C. RD/BU<br>D. WH/GN<br>E. BK<br>F. BN/GN<br>G. PK<br>H. WH/YE<br>I. GN<br>K. YE/BN<br>L. BN<br>M. OG<br>N. GY/BN<br>O. VT<br>P. WH<br>R. RD<br>S. GY<br>T. YE<br>U. TN       |
| <p><b>BSWM ..</b></p> |   |   |   |  |



We reserve the right to make technical alterations without prior notice.

\* Length in meters. Standard cable lengths are 5 and 10 meters. Consult factory for other lengths. Standard housing and coupling nut material is anodized aluminum.. "BKM.."; "BKMV.." indicates stainless steel and "BKMK.." indicates nylon.

**M16 Receptacle Selection Guide**

| Mounting Style            | Image   | Panel Thread Types  | Page       |            |            |            |                   |            |                   |            |  |
|---------------------------|---|---|------------|------------|------------|------------|-------------------|------------|-------------------|------------|--|
| <p><b>Front Mount</b></p> |    | <table border="1"> <tr> <td><b>M18</b></td> <td><b>G12</b></td> </tr> <tr> <td><b>M20</b></td> <td><b>G14</b></td> </tr> <tr> <td><b>1/2-14 NPT</b></td> <td><b>G16</b></td> </tr> <tr> <td><b>3/8-18 NPT</b></td> <td><b>G18</b></td> </tr> </table> | <b>M18</b> | <b>G12</b> | <b>M20</b> | <b>G14</b> | <b>1/2-14 NPT</b> | <b>G16</b> | <b>3/8-18 NPT</b> | <b>G18</b> |  |
| <b>M18</b>                | <b>G12</b>  |   |            |            |            |            |                   |            |                   |            |  |
| <b>M20</b>                | <b>G14</b>  |   |            |            |            |            |                   |            |                   |            |  |
| <b>1/2-14 NPT</b>         | <b>G16</b>  |   |            |            |            |            |                   |            |                   |            |  |
| <b>3/8-18 NPT</b>         | <b>G18</b>  |   |            |            |            |            |                   |            |                   |            |  |
| <p><b>Rear Mount</b></p>  |   | <table border="1"> <tr> <td><b>M18</b></td> <td><b>G22</b></td> </tr> </table>  | <b>M18</b> | <b>G22</b> |            |            |                   |            |                   |            |  |
| <b>M18</b>                | <b>G22</b>  |   |            |            |            |            |                   |            |                   |            |  |
| <p><b>PCB Mount</b></p>   |  | <table border="1"> <tr> <td><b>PCB</b></td> <td><b>G24</b></td> </tr> </table>  | <b>PCB</b> | <b>G24</b> |            |            |                   |            |                   |            |  |
| <b>PCB</b>                | <b>G24</b>  |   |            |            |            |            |                   |            |                   |            |  |

We reserve the right to make technical alterations without prior notice.

Receptacles

## 5 - 8 Pin Receptacles, Front Mount

- IEC IP67 Protection



| Connector Style               | Female Part Number | Male Part Number | Features  | Pinout                                  |
|-------------------------------|--------------------|------------------|---|---|
| <p><b>BKF ..(5-8 pin)</b></p> | <b>BKF 5-5-*</b>   | <b>BSF 5-5-*</b> | 5x20 AWG, 105 °C, 300 VAC/VDC, 8 A, 5-Wire DC Application | <p><b>Female</b></p> <p><b>Male</b></p> |
|                               | <b>BKF 6-6-*</b>   | <b>BSF 6-6-*</b> | 6x20 AWG, 105 °C, 300 VAC/VDC, 7 A, 6-Wire DC Application | <p><b>Female</b></p> <p><b>Male</b></p> |
|                               | <b>BKF 7-7-*</b>   | <b>BSF 7-7-*</b> | 7x20 AWG, 105 °C, 125 VAC/VDC, 7 A, 7-Wire DC Application | <p><b>Female</b></p> <p><b>Male</b></p> |
|                               | <b>BKF 8-8-*</b>   | <b>BSF 8-8-*</b> | 8x20 AWG, 105 °C, 125 VAC/VDC, 7 A, 8-Wire DC Application | <p><b>Female</b></p> <p><b>Male</b></p> |

We reserve the right to make technical alterations without prior notice.

\* Length in meters. Standard lead length is 0.5 meters. Consult factory for other lengths.  
 Standard housing material is nickel plated brass.  
 To specify PVC jacketed cable, add "/S717" to the end of the part number.



## 12, 14 and 19-Pin Receptacles, Front Mount

- For use with Junction Box Home Run Cables
- IEC IP67 Protection



| Connector Style  | Female Part Number | Male Part Number   | Features   | Pinout                                  |
|--|--------------------|--------------------|--|---|
| <p><b>BKF ..(12, 14, 19 pin)</b></p> <p>Typical panel cutout is 18 x 17 mm</p> | <b>BKF 12-12-*</b> | <b>BSF 12-12-*</b> | 12x24 AWG, 105 °C, 125 VAC/VDC, 4 A, mates with 12-pin connectors, 12 conductors | <p><b>Female</b></p> <p><b>Male</b></p> |
|  | <b>BKF 14-10-*</b> | <b>BSF 14-10-*</b> | 10x24 AWG, 105 °C, 30 VAC/VDC, 3 A, mates with 14-pin connectors, 10 conductors  | <p><b>Female</b></p>                    |
|  | <b>BKF 14-12-*</b> | <b>BSF 14-12-*</b> | 12x24 AWG, 105 °C, 30 VAC/VDC, 3 A, mates with 14-pin connectors, 12 conductors  | <p><b>Female</b></p> <p><b>Male</b></p> |
|  | <b>BKF 14-14-*</b> | <b>BSF 14-14-*</b> | 14x24 AWG, 105 °C, 30 VAC/VDC, 3 A, mates with 14-pin connectors, 14 conductors  | <p><b>Female</b></p> <p><b>Male</b></p> |
|  | <b>BKF 19-19-*</b> | <b>BSF 19-19-*</b> | 19x24 AWG, 105 °C, 30 VAC/VDC, 3 A, mates with 19-pin connectors, 19 conductors  | <p><b>Female</b></p> <p><b>Male</b></p> |

We reserve the right to make technical alterations without prior notice.

Receptacles

\* Length in meters. Standard lead length is 0.5 meters. Consult factory for other lengths. Standard housing material is nickel plated brass. To specify PVC jacketed cable, add "/S717" to the end of the part number.

• IEC IP67 Protection



| Connector Style                    | Female Part Number   | Male Part Number     | Features  | Pinout                                  |
|------------------------------------|----------------------|----------------------|---|---|
| <p><b>BKF .. M18 (5-8 pin)</b></p> | <b>BKF 5-5-*/M18</b> | <b>BSF 5-5-*/M18</b> | 5x18 AWG, 105 °C, 300 VAC/VDC, 8 A, 5-wire DC application | <p><b>Female</b></p> <p><b>Male</b></p> |
|                                    | <b>BKF 6-6-*/M18</b> | <b>BSF 6-6-*/M18</b> | 6x18 AWG, 105 °C, 300 VAC/VDC, 7 A, 6-wire DC application | <p><b>Female</b></p> <p><b>Male</b></p> |
|                                    | <b>BKF 7-7-*/M18</b> | <b>BSF 7-7-*/M18</b> | 7x18 AWG, 105 °C, 125 VAC/VDC, 7 A, 7-wire DC application | <p><b>Female</b></p> <p><b>Male</b></p> |
|                                    | <b>BKF 8-8-*/M18</b> | <b>BSF 8-8-*/M18</b> | 8x18 AWG, 105 °C, 125 VAC/VDC, 7 A, 8-wire DC application | <p><b>Female</b></p> <p><b>Male</b></p> |

We reserve the right to make technical alterations without prior notice.

\* Length in meters. Standard lead length is 0.5 meters. Consult factory for other lengths.  
 Standard housing material is nickel plated brass "BSF.." and "BSFV.." indicates stainless steel.  
 To specify PVC jacketed cable, add "/S717" to the end of the part number.

12, 14 and 19-Pin Receptacles, Front Mount, M18 Threads

- For use with Junction Box Home Run Cables
- IEC IP67 Protection



| Connector Style  | Female Part Number     | Male Part Number       | Features   | Pinout   |  |   |
|--|------------------------|------------------------|--|--|--|---|
| <p><b>BKF .. M18 (12, 14, 19 pin)</b></p> <p>Typical panel cutout is 18.6 mm</p> | <b>BKF 12-12-*/M18</b> | <b>BSF 12-12-*/M18</b> | 12x22 AWG, 105 °C, 125 VAC/VDC, 4 A, mates with 12-pin connectors, 12 conductors | A. BN<br>B. BU<br>C. WH<br>D. GN<br>E. YE<br>F. GY<br>G. PK<br>H. RD<br>J. BK<br>K. OG<br>L. TN<br>M. VT | <p><b>Female</b></p> <p><b>Male</b></p>  |   |
|  | <b>BKF 14-10-*/M18</b> | <b>BSF 14-10-*/M18</b> | 10x22 AWG, 105 °C, 30 VAC/VDC, 3 A, mates with 14-pin connectors, 10 conductors  | C. GY<br>E. GN<br>G. BK<br>M. BN<br>N. PK  | O. YE<br>P. WH<br>R. RD<br>S. VT<br>U. BU  | <p><b>Female</b></p>                    |
|  | <b>BKF 14-12-*/M18</b> | <b>BSF 14-12-*/M18</b> | 12x22 AWG 105 °C 30 VAC/VDC, 3 A mates with 14-pin connectors, 12 conductors     | C. OG<br>E. BK<br>G. GN<br>J. GY<br>M. BN<br>N. TN   | O. VT<br>P. RD<br>R. WH<br>S. YE<br>T. PK<br>U. BU                               | <p><b>Male</b></p>                      |
|  | <b>BKF 14-14-*/M18</b> | <b>BSF 14-14-*/M18</b> | 14x22 AWG, 105 °C, 30 VAC/VDC, 3 A, mates with 14-pin connectors, 14 conductors  | A. BN<br>C. RD/BU<br>E. BK<br>G. PK<br>J. GN<br>L. BU<br>M. OG   | N. GY/BN<br>O. VT<br>P. WH<br>R. RD<br>S. GY<br>T. YE<br>U. TN                   | <p><b>Female</b></p>                    |
|  | <b>BKF 19-19-*/M18</b> | <b>BSF 19-19-*/M18</b> | 19x22 AWG, 105 °C, 30 VAC/VDC, 3 A, mates with 19-pin connectors, 19 conductors  | A. BU<br>B. GY/PK<br>C. RD/BU<br>D. WH/GN<br>E. BK<br>F. BN/GN<br>G. PK<br>H. WH/YE<br>I. GN<br>K. YE/BN | L. BN<br>M. OG<br>N. GY/BN<br>O. VT<br>P. WH<br>R. RD<br>S. GY<br>T. YE<br>U. TN | <p><b>Female</b></p> <p><b>Male</b></p> |

We reserve the right to make technical alterations without prior notice.

Receptacles

\* Length in meters. Standard lead length is 0.5 meters. Consult factory for other lengths. Standard housing material is nickel plated brass "BSF.." and "BSFV.." indicates stainless steel. To specify PVC jacketed cable, add "/S717" to the end of the part number.

• IEC IP67 Protection



| Connector Style                   | Female Part Number   | Male Part Number     | Features   | Pinout                                  |
|-----------------------------------|----------------------|----------------------|--|---|
| <p><b>BKF ..M20 (5-8 pin)</b></p> | <b>BKF 5-5-*/M20</b> | <b>BSF 5-5-*/M20</b> | 5x18 AWG, 105 °C, 300 VAC/VDC, 8 A, 5-Wire DC applications | <p><b>Female</b></p> <p><b>Male</b></p> |
|                                   | <b>BKF 6-6-*/M20</b> | <b>BSF 6-6-*/M20</b> | 6x18 AWG, 105 °C, 300 VAC/VDC, 7 A, 6-Wire DC applications | <p><b>Female</b></p> <p><b>Male</b></p> |
| <p><b>BSF ..M20 (5-8 pin)</b></p> | <b>BKF 7-7-*/M20</b> | <b>BSF 7-7-*/M20</b> | 7x18 AWG, 105 °C, 125 VAC/VDC, 7 A, 7-Wire DC applications | <p><b>Female</b></p> <p><b>Male</b></p> |
|                                   | <b>BKF 8-8-*/M20</b> | <b>BSF 8-8-*/M20</b> | 8x18 AWG, 105 °C, 125 VAC/VDC, 7 A, 8-Wire DC applications | <p><b>Female</b></p> <p><b>Male</b></p> |

We reserve the right to make technical alterations without prior notice.

\* Length in meters. Standard lead length is 0.5 meters. Consult factory for other lengths.  
Standard housing material is nickel plated brass "BSF.." and "BSFV.." indicates stainless steel.  
To specify PVC jacketed cable, add "/S717" to the end of the part number.





## 12, 14 and 19-Pin Receptacles, Front Mount, M20 Threads

- For use with Junction Box Home Run Cables
- IEC IP67 Protection



| Connector Style  | Female Part Number     | Male Part Number       | Features   | Pinout   |
|--|------------------------|------------------------|--|--|
| <p><b>BKF ..M20 (12, 14, 19 pin)</b></p> <p>Typical panel cutout is 18.6 mm</p>  | <b>BKF 12-12-*/M20</b> | <b>BSF 12-12-*/M20</b> | 12x22 AWG, 105 °C, 125 VAC/VDC, 4 A, mates with 12-pin connectors, 12 conductors | <p><b>Female</b></p> <p><b>Male</b></p>  |
|  |                        |                        |  | <p><b>BKF 14-10-*/M20</b></p> <p><b>BSF 14-10-*/M20</b></p> <p>10x22 AWG, 105 °C, 30 VAC/VDC, 3 A, mates with 14-pin connectors, 10 conductors</p> <p><b>Female</b></p> <p><b>Male</b></p> |
| <p><b>BSF ..M20 (12, 14, 19 pin)</b></p> <p>Typical panel cutout is 20.4 mm</p>  | <b>BKF 14-12-*/M20</b> | <b>BSF 14-12-*/M20</b> | 12x22 AWG, 105 °C, 30 VAC/VDC, 3 A, mates with 14-pin connectors, 12 conductors  | <p><b>Female</b></p> <p><b>Male</b></p>  |
|  |                        |                        |  | <p><b>BKF 14-14-*/M20</b></p> <p><b>BSF 14-14-*/M20</b></p> <p>14x22 AWG, 105 °C, 30 VAC/VDC, 3 A, mates with 14-pin connectors, 14 conductors</p> <p><b>Female</b></p> <p><b>Male</b></p> |
| <p><b>BKF 19-19-*/M20</b></p> <p><b>BSF 19-19-*/M20</b></p> <p>19x22 AWG, 105 °C, 30 VAC/VDC, 3 A, mates with 19-pin connectors, 19 conductors</p> | <b>BKF 19-19-*/M20</b> | <b>BSF 19-19-*/M20</b> |  | <p><b>Female</b></p> <p><b>Male</b></p>  |
|  |                        |                        |  | <p><b>BKF 19-19-*/M20</b></p> <p><b>BSF 19-19-*/M20</b></p> <p>19x22 AWG, 105 °C, 30 VAC/VDC, 3 A, mates with 19-pin connectors, 19 conductors</p>   |

We reserve the right to make technical alterations without prior notice.

Receptacles

\* Length in meters. Standard lead length is 0.5 meters. Consult factory for other lengths. Standard housing material is nickel plated brass "BSF.." and "BSFV.." indicates stainless steel. To specify PVC jacketed cable, add "/S717" to the end of the part number.

## 5 - 8 Pin Receptacles, Front Mount, 1/2-14 NPT Threads

• IEC IP67 Protection



| Connector Style   | Female Part Number        | Male Part Number          | Features   | Pinout                                  |
|---|---------------------------|---------------------------|--|---|
| <p><b>BKF ..1/2-14 NPT (5-8 pin)</b></p> <p>Typical panel cutout is 17.5 mm</p> | <b>BKF 5-5-*/14.5/NPT</b> | <b>BSF 5-5-*/14.5/NPT</b> | 5x18 AWG, 105 °C, 300 VAC/VDC, 8 A, 5-Wire DC applications | <p><b>Female</b></p> <p><b>Male</b></p> |
|   | <b>BKF 6-6-*/14.5/NPT</b> | <b>BSF 6-6-*/14.5/NPT</b> | 6x18 AWG, 105 °C, 300 VAC/VDC, 7 A, 6-Wire DC applications | <p><b>Female</b></p> <p><b>Male</b></p> |
|   | <b>BKF 7-7-*/14.5/NPT</b> | <b>BSF 7-7-*/14.5/NPT</b> | 7x18 AWG, 105 °C, 125 VAC/VDC, 7 A, 7-Wire DC applications | <p><b>Female</b></p> <p><b>Male</b></p> |
| <p><b>BSF ..1/2-14 NPT (5-8 pin)</b></p> <p>Typical panel cutout is 22.5 mm</p> | <b>BKF 8-8-*/14.5/NPT</b> | <b>BSF 8-8-*/14.5/NPT</b> | 8x18 AWG, 105 °C, 125 VAC/VDC, 7 A, 8-Wire DC applications | <p><b>Female</b></p> <p><b>Male</b></p> |

We reserve the right to make technical alterations without prior notice.

\* Length in meters. Standard lead length is 0.5 meters. Consult factory for other lengths.  
 Standard housing material is nickel plated brass "BSF.." and "BSFV.." indicates stainless steel.  
 To specify PVC jacketed cable, add "/S717" to the end of the part number.



## 12, 14 and 19-Pin Receptacles, Front Mount, 1/2-14 NPT Threads

- For use with Junction Box Home Run Cables
- IEC IP67 Protection



| Connector Style                                 | Female Part Number          | Male Part Number            | Features   | Pinout   |          |   |
|---|-----------------------------|-----------------------------|--|----------|----------|---|
| <p><b>BKF ..1/2-14 NPT (12, 14, 19 pin)</b></p> | <b>BKF 12-12-*/14.5/NPT</b> | <b>BSF 12-12-*/14.5/NPT</b> | 12x22 AWG, 105 °C, 125 VAC/VDC, 4 A, mates with 12-pin connectors, 12 conductors | A. BN    | G. PK    | <p><b>Female</b></p> <p><b>Male</b></p> |
|   |                             |                             |  | B. BU    | H. RD    |   |
|   | <b>BKF 14-10-*/14.5/NPT</b> | <b>BSF 14-10-*/14.5/NPT</b> | 10x22 AWG, 105 °C, 30 VAC/VDC, 3 A, mates with 14-pin connectors, 10 conductors  | C. GY    | O. YE    | <p><b>Female</b></p>                    |
|   |                             |                             |  | E. GN    | P. WH    |   |
|   | <b>BKF 14-12-*/14.5/NPT</b> | <b>BSF 14-12-*/14.5/NPT</b> | 12x22 AWG, 105 °C, 30 VAC/VDC, 3 A, mates with 14-pin connectors, 12 conductors  | G. BK    | R. RD    | <p><b>Male</b></p>                      |
|   |                             |                             |  | M. BN    | S. VT    |   |
|   | <b>BKF 14-14-*/14.5/NPT</b> | <b>BSF 14-14-*/14.5/NPT</b> | 14x22 AWG, 105 °C, 30 VAC/VDC, 3 A, mates with 14-pin connectors, 14 conductors  | N. PK    | U. BU    | <p><b>Female</b></p>                    |
|   |                             |                             |  | C. OG    | O. VT    |   |
| <p><b>BSF ..1/2-14 NPT (12, 14, 19 pin)</b></p> | <b>BKF 19-19-*/14.5/NPT</b> | <b>BSF 19-19-*/14.5/NPT</b> | 19x22 AWG, 105 °C, 30 VAC/VDC, 3 A, mates with 19-pin connectors, 19 conductors  | A. BU    | L. BN    | <p><b>Female</b></p> <p><b>Male</b></p> |
|   |                             |                             |  | B. GY/PK | M. OG    |   |
|   |                             |                             |  | C. RD/BU | N. GY/BN |   |
|   |                             |                             |  | D. WH/GN | O. VT    |   |
|   |                             |                             |  | E. BK    | P. WH    |   |
|   |                             |                             |  | F. BN/GN | R. RD    |   |
|   |                             |                             |  | G. PK    | S. GY    |   |
|   |                             |                             |  | H. WH/YE | T. YE    |   |
|   |                             |                             |  | I. GN    | U. TN    |   |
|   |                             |                             |  | K. YE/BN |          |   |

We reserve the right to make technical alterations without prior notice.

Receptacles

\* Length in meters. Standard lead length is 0.5 meters. Consult factory for other lengths. Standard housing material is nickel plated brass "BSF.." and "BSFV.." indicates stainless steel. To specify PVC jacketed cable, add "/S717" to the end of the part number.

## 5 - 8 Pin Receptacles, Front Mount, 3/8-18 NPT Threads

- IEC IP67 Protection



| Connector Style   | Female Part Number          | Male Part Number            | Features   | Pinout                                  |
|---|-----------------------------|-----------------------------|--|---|
| <p><b>BKF ..3/8-18 NPT (5-8 pin)</b></p> <p>Typical panel cutout is 17.5 mm</p> | <b>BKF 5-5-*/18.375/NPT</b> | <b>BSF 5-5-*/18.375/NPT</b> | 5x18 AWG, 105 °C, 300 VAC/VDC, 8 A, 5-Wire DC applications | <p><b>Female</b></p> <p><b>Male</b></p> |
| <p><b>BKF 6-6-*/18.375/NPT</b></p> <p>Typical panel cutout is 17.5 mm</p>       | <b>BKF 6-6-*/18.375/NPT</b> | <b>BSF 6-6-*/18.375/NPT</b> | 6x18 AWG, 105 °C, 300 VAC/VDC, 7 A, 6-Wire DC applications | <p><b>Female</b></p> <p><b>Male</b></p> |
| <p><b>BSF ..3/8-18 NPT (5-8 pin)</b></p> <p>Typical panel cutout is 17.5 mm</p> | <b>BKF 7-7-*/18.375/NPT</b> | <b>BSF 7-7-*/18.375/NPT</b> | 7x18 AWG, 105 °C, 125 VAC/VDC, 7 A, 7-Wire DC applications | <p><b>Female</b></p> <p><b>Male</b></p> |
| <p><b>BSF ..3/8-18 NPT (5-8 pin)</b></p> <p>Typical panel cutout is 17.5 mm</p> | <b>BKF 8-8-*/18.375/NPT</b> | <b>BSF 8-8-*/18.375/NPT</b> | 8x18 AWG, 105 °C, 125 VAC/VDC, 7 A, 8-Wire DC applications | <p><b>Female</b></p> <p><b>Male</b></p> |

We reserve the right to make technical alterations without prior notice.

\* Length in meters. Standard lead length is 0.5 meters. Consult factory for other lengths.  
Standard housing material is nickel plated brass "BSF..".  
To specify PVC jacketed cable, add "/S717" to the end of the part number.

## 12, 14 and 19-Pin Receptacles, Front Mount, 3/8-18 NPT Threads

- For use with Junction Box Home Run Cables
- IEC IP67 Protection



| Connector Style  | Female Part Number            | Male Part Number  | Features   | Pinout   |                               |
|--|-------------------------------|---|--|--|-------------------------------|
| <p><b>BKF ..3/8-18 NPT (12, 14, 19 pin)</b></p> <p>Typical panel cutout is 17.5 mm</p> | <b>BKF 12-12-*/18.375/NPT</b> | <b>BSF 12-12-*/18.375/NPT</b>   | 12x22 AWG, 105 °C, 125 VAC/VDC, 4 A, mates with 12-pin connectors, 12 conductors   | <p><b>Female</b></p> <p>A. BN    G. PK<br/>B. BU    H. RD<br/>C. WH    J. BK<br/>D. GN    K. OG<br/>E. YE    L. TN<br/>F. GY    M. VT</p> <p><b>Male</b></p> |                               |
|  |                               |   |  | <p><b>BKF 14-10-*/18.375/NPT</b></p>   | <b>BSF 14-10-*/18.375/NPT</b> |
| <p><b>BKF 14-12-*/18.375/NPT</b></p>   | <b>BSF 14-12-*/18.375/NPT</b> | 12x22 AWG, 105 °C, 30 VAC/VDC, 3 A, mates with 14-pin connectors, 12 conductors | <p><b>Female</b></p> <p>C. OG    O. VT<br/>E. BK    P. RD<br/>G. GN    R. WH<br/>J. GY    S. YE<br/>M. BN    T. PK<br/>N. TN    U. BU</p> <p><b>Male</b></p> |  |                               |
|  |                               |   | <p><b>BSF ..3/8-18 NPT (12, 14, 19 pin)</b></p> <p>Typical panel cutout is 17.5 mm</p>   | <b>BKF 14-14-*/18.375/NPT</b>  | <b>BSF 14-14-*/18.375/NPT</b> |
| <p><b>BKF 19-19-*/18.375/NPT</b></p>   | <b>BSF 19-19-*/18.375/NPT</b> | 19x22 AWG, 105 °C, 30 VAC/VDC, 3 A, mates with 19-pin connectors, 19 conductors |  |  |                               |

We reserve the right to make technical alterations without prior notice.

Receptacles

\* Length in meters. Standard lead length is 0.5 meters. Consult factory for other lengths. Standard housing material is nickel plated brass "BSF..". To specify PVC jacketed cable, add "/S717" to the end of the part number.

## 5 - 8 Wire Receptacles, Rear Mount

• IEC IP67 Protection



| Connector Style  | Female Part Number | Male Part Number  | Features  | Pinout                                  |
|--|--------------------|-------------------|---|---|
| <p><b>BKFD .. (5-8 pin)</b></p> <p>Typical panel cutout is 18 x 17 mm</p>        | <b>BKFD 5-5-*</b>  | <b>BSFD 5-5-*</b> | 5x20 AWG, 105 °C, 300 VAC/VDC, 8 A, 5-Wire DC application | <p><b>Female</b></p> <p><b>Male</b></p> |
|  | <b>BKFD 6-6-*</b>  | <b>BSFD 6-6-*</b> | 6x20 AWG, 105 °C, 300 VAC/VDC, 7 A, 6-Wire DC application | <p><b>Female</b></p> <p><b>Male</b></p> |
| <p><b>BSFD .. (5-8, 12-19 pin)</b></p> <p>Typical panel cutout is 18 x 17 mm</p> | <b>BKFD 7-7-*</b>  | <b>BSFD 7-7-*</b> | 7x20 AWG, 105 °C, 125 VAC/VDC, 7 A, 7-Wire DC application | <p><b>Female</b></p> <p><b>Male</b></p> |
|  | <b>BKFD 8-8-*</b>  | <b>BSFD 8-8-*</b> | 8x20 AWG, 105 °C, 125 VAC/VDC, 7 A, 8-Wire DC application | <p><b>Female</b></p> <p><b>Male</b></p> |

We reserve the right to make technical alterations without prior notice.

\* Length in meters. Standard lead lengths is 0.5 meters. Consult factory for other lengths.  
Standard housing material is nickel plated brass.  
To specify PVC jacketed cable, add "/S717" to the end of the part number.



## 12, 14 and 19-Pin Receptacles, Rear Mount

- For use with Junction Box Home Run Cables
- IEC IP67 Protection



| Connector Style   | Female Part Number  | Male Part Number    | Features   | Pinout                                  |
|---|---------------------|---------------------|--|---|
| <p><b>BKFD ..(12, 14, 19 pin)</b></p> <p>Typical panel cutout is 18 x 17 mm</p> | <b>BKFD 12-12-*</b> | <b>BSFD 12-12-*</b> | 12x24 AWG, 105 °C, 125 VAC/VDC, 4 A, mates with 12-pin connectors, 12 conductors | <p><b>Female</b></p> <p><b>Male</b></p> |
|   | <b>BKFD 14-10-*</b> | <b>BSFD 14-10-*</b> | 10x24 AWG, 105 °C, 30 VAC/VDC, 3 A, mates with 14-pin connectors, 10 conductors  | <p><b>Female</b></p>                    |
|   | <b>BKFD 14-12-*</b> | <b>BSFD 14-12-*</b> | 12x24 AWG, 105 °C, 30 VAC/VDC, 3 A, mates with 14-pin connectors, 12 conductors  | <p><b>Female</b></p> <p><b>Male</b></p> |
|   | <b>BKFD 14-14-*</b> | <b>BSFD 14-14-*</b> | 14x24 AWG, 105 °C, 30 VAC/VDC, 3 A, mates with 14-pin connectors, 14 conductors  | <p><b>Female</b></p> <p><b>Male</b></p> |
|   | <b>BKFD 19-19-*</b> | <b>BSFD 19-19-*</b> | 19x24 AWG, 105 °C, 30 VAC/VDC, 3 A, mates with 19-pin connectors, 19 conductors  | <p><b>Female</b></p> <p><b>Male</b></p> |

We reserve the right to make technical alterations without prior notice.

Receptacles

\* Length in meters. Standard lead lengths is 0.5 meters. Consult factory for other lengths. Standard housing material is nickel plated brass. To specify PVC jacketed cable, add "/S717" to the end of the part number.

• IEC IP67 Protection



| Connector Style  | Female Part Number    | Male Part Number      | Features   | Pinout                                  |
|--|-----------------------|-----------------------|--|---|
| <p><b>BKFD .. M18 (5-8 pin)</b></p> <p>Typical panel cutout is 18.6 mm</p> | <b>BKFD 5-5-*/M18</b> | <b>BSFD 5-5-*/M18</b> | 5x18 AWG, 105 °C, 300 VAC/VDC, 8 A, 5-Wire DC applications | <p><b>Female</b></p> <p><b>Male</b></p> |
|  | <b>BKFD 6-6-*/M18</b> | <b>BSFD 6-6-*/M18</b> | 6x18 AWG, 105 °C, 300 VAC/VDC, 7 A, 6-Wire DC applications | <p><b>Female</b></p> <p><b>Male</b></p> |
| <p><b>BSFD.. M18 (5-8 pin)</b></p> <p>Typical panel cutout is 18.6 mm</p>  | <b>BKFD 7-7-*/M18</b> | <b>BSFD 7-7-*/M18</b> | 7x18 AWG, 105 °C, 125 VAC/VDC, 7 A, 7-Wire DC applications | <p><b>Female</b></p> <p><b>Male</b></p> |
|  | <b>BKFD 8-8-*/M18</b> | <b>BSFD 8-8-*/M18</b> | 8x18 AWG, 105 °C, 125 VAC/VDC, 7 A, 8-Wire DC applications | <p><b>Female</b></p> <p><b>Male</b></p> |

We reserve the right to make technical alterations without prior notice.

\* Length in meters. Standard lead length is 0.5 meter. Consult factory for other lengths.  
Standard housing material is nickel plated brass. "BSFDV.." indicates stainless steel.  
To specify PVC jacketed cable, add "/S717" to the end of the part number.



## 12, 14 and 19-Pin Receptacles, Rear Mount, M18 Threads

• IEC IP67 Protection



| Connector Style   | Female Part Number      | Male Part Number  | Features   | Pinout   |  |   |
|---|-------------------------|---|--|--|--|---|
| <p><b>BKFD .. M18 (12, 14, 19 pin)</b></p> <p>Typical panel cutout is 18.6 mm</p> | <b>BKFD 12-12-*/M18</b> | <b>BSFD 12-12-*/M18</b>   | 12x22 AWG, 105 °C, 125 VAC/VDC, 4 A, mates with 12-pin connectors, 12 conductors | A. BN<br>B. BU<br>C. WH<br>D. GN<br>E. YE<br>F. GY   | G. PK<br>H. RD<br>J. BK<br>K. OG<br>L. TN<br>M. VT                               | <p><b>Female</b></p> <p><b>Male</b></p> |
|   | <b>BKFD 14-10-*/M18</b> | <b>BSFD 14-10-*/M18</b>   | 10x22 AWG, 105 °C, 30 VAC/VDC, 3 A, mates with 14-pin connectors, 10 conductors  | C. GY<br>E. GN<br>G. BK<br>M. BN<br>N. PK  | O. YE<br>P. WH<br>R. RD<br>S. VT<br>U. BU  | <p><b>Female</b></p>                    |
| <b>BKFD 14-12-*/M18</b>   | <b>BSFD 14-12-*/M18</b> | 12x22 AWG, 105 °C, 30 VAC/VDC, 3 A, mates with 14-pin connectors, 12 conductors | C. OG<br>E. BK<br>G. GN<br>J. GY<br>M. BN<br>N. TN                               | O. VT<br>P. RD<br>R. WH<br>S. YE<br>T. PK<br>U. BU   | <p><b>Male</b></p>   |   |
| <p><b>BSFD.. M18 (12, 14, 19 pin)</b></p> <p>Typical panel cutout is 18.6 mm</p>  | <b>BKFD 14-14-*/M18</b> | <b>BSFD 14-14-*/M18</b>   | 14x22 AWG, 105 °C, 30 VAC/VDC, 3 A, mates with 14-pin connectors, 14 conductors  | A. BN<br>C. RD/BU<br>E. BK<br>G. PK<br>J. GN<br>L. BU<br>M. OG   | N. GY/BN<br>O. VT<br>P. WH<br>R. RD<br>S. GY<br>T. YE<br>U. TN                   | <p><b>Female</b></p> <p><b>Male</b></p> |
|   | <b>BKFD 19-19-*/M18</b> | <b>BSFD 19-19-*/M18</b>   | 19x22 AWG, 105 °C, 30 VAC/VDC, 3 A, mates with 19-pin connectors, 19 conductors  | A. BU<br>B. GY/PK<br>C. RD/BU<br>D. WH/GN<br>E. BK<br>F. BN/GN<br>G. PK<br>H. WH/YE<br>I. GN<br>K. YE/BN | L. BN<br>M. OG<br>N. GY/BN<br>O. VT<br>P. WH<br>R. RD<br>S. GY<br>T. YE<br>U. TN | <p><b>Female</b></p> <p><b>Male</b></p> |

We reserve the right to make technical alterations without prior notice.

Receptacles

\* Length in meters. Standard lead length is 0.5 meter. Consult factory for other lengths. Standard housing material is nickel plated brass. "BSFDV.." indicates stainless steel. To specify PVC jacketed cable, add "/S717" to the end of the part number.

## 5 - 8 Pin Receptacles, Rear Mount, PCB Pins

- Locknuts and O-rings included
- Easy Keyway Orientation
- IEC IP67 Protection



| Connector Style | Female Part Number | Male Part Number  | Features  | Pinout |
|-----------------|--------------------|-------------------|---|--------|
|                 | <b>BKFD 5-PCB</b>  | <b>BSFD 5-PCB</b> | Nickel plated brass, 5-pin PCB pins, 105 °C, 60 V, 5 A, M18 x .75 threads, mates with 5-pin cordsets  |        |
|                 | <b>BKFD 6-PCB</b>  | <b>BSFD 6-PCB</b> | Nickel plated brass, 5-pin PCB pins, 105 °C, 250 V, 5 A, M18 x .75 threads, mates with 6-pin cordsets |        |
|                 | <b>BKFD 7-PCB</b>  | <b>BSFD 7-PCB</b> | Nickel plated brass, 5-pin PCB pins, 105 °C, 60 V, 5 A, M18 x .75 threads, mates with 7-pin cordsets  |        |
|                 | <b>BKFD 8-PCB</b>  | <b>BSFD 8-PCB</b> | Nickel plated brass, 5-pin PCB pins, 105 °C, 60 V, 5 A, M18 x .75 threads, mates with 8-pin cordsets  |        |

We reserve the right to make technical alterations without prior notice.

**5-Pin PCB Layout**

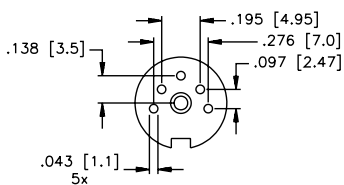

**6-Pin PCB Layout**

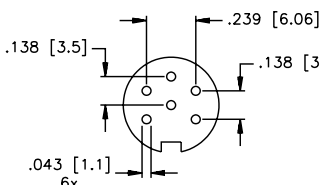

**7-Pin PCB Layout**

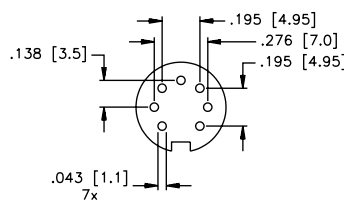

**8-Pin PCB Layout**

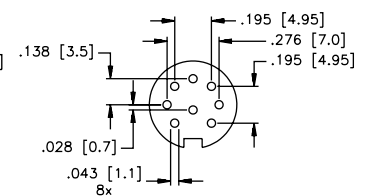

12, 14 and 19-Pin Receptacles, Rear Mount, PCB Pins

- Locknuts and O-rings included
- Easy Keyway Orientation
- IEC IP67 Protection

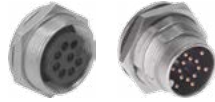

We reserve the right to make technical alterations without prior notice.

| Connector Style                           | Female Part Number | Male Part Number   | Features   | Pinout                                  |
|---|--------------------|--------------------|--|---|
| <p><b>BKFD ..PCB (12, 14, 19 pin)</b></p> | <b>BKFD 12-PCB</b> | <b>BSFD 12-PCB</b> | Nickel plated brass, 12-pin PCB pins, 105 °C, 60 V, 3 A, M18 x .75 threads, mates with 12-pin cordsets | <p><b>Female</b></p> <p><b>Male</b></p> |
|   | <b>BKFD 14-PCB</b> | <b>BSFD 14-PCB</b> | Nickel plated brass, 14-pin PCB pins, 105 °C, 60 V, 3 A, M18 x .75 threads, mates with 14-pin cordsets | <p><b>Female</b></p> <p><b>Male</b></p> |
| <p><b>BSFD ..PCB (12, 14, 19 pin)</b></p> | <b>BKFD 19-PCB</b> | <b>BSFD 19-PCB</b> | Nickel plated brass, 19-pin PCB pins, 105 °C, 60 V, 3 A, M18 x .75 threads, mates with 19-pin cordsets | <p><b>Female</b></p> <p><b>Male</b></p> |

5-Pin PCB Layout

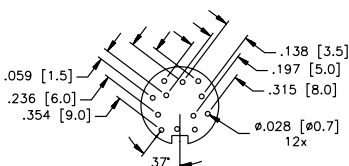

7-Pin PCB Layout

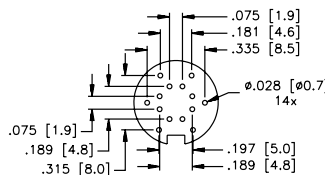

8-Pin PCB Layout

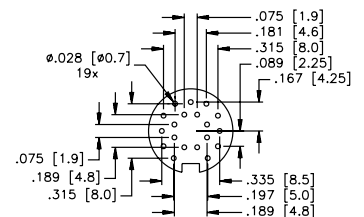

Receptacles

## 12, 14 and 19-Pin Receptacles, Solder Cups, Front and Rear Mount

- Facilitates Field Replacements



| Connector Style                     | Female Part Number | Male Part Number | Features   | Pinout               |
|-------------------------------------|--------------------|------------------|--|----------------------|
| <p><b>BKF (12, 14, 19 pin)</b></p>  | <b>BKF 12</b>      | <b>BSF 12</b>    | Nickel plated brass, solder cup, accepts up to 12x24 AWG conductors, 95 °C, 125 V, 4 A, mates with Picofast® junction boxes, front mount | <p><b>Female</b></p> |
|                                     | <b>BKFD 12</b>     | <b>BSFD 12</b>   | Nickel plated brass, solder cup, accepts up to 12x24 AWG conductors, 95 °C, 125 V, 3 A, mates with Picofast junction boxes, rear mount   | <p><b>Male</b></p>   |
| <p><b>BKFD (12, 14, 19 pin)</b></p> | <b>BKF 14</b>      | <b>BSF 14</b>    | Nickel plated brass, solder cup, accepts up to 14x24 AWG conductors, 95 °C, 125 V, 3 A, mates with Picofast junction boxes, front mount  | <p><b>Female</b></p> |
|                                     | <b>BKFD 14</b>     | <b>BSFD 14</b>   | Nickel plated brass, solder cup, accepts up to 14x24 AWG conductors, 95 °C, 125 V, 3 A, mates with Picofast junction boxes, rear mount   | <p><b>Male</b></p>   |
| <p><b>BSF (12, 14, 19 pin)</b></p>  | <b>BKF 19</b>      | <b>BSF 19</b>    | Nickel plated brass, solder cup, accepts up to 19x24 AWG conductors, 95 °C, 125 V, 3 A, mates with Picofast junction boxes, front mount  | <p><b>Female</b></p> |
| <p><b>BSFD (12, 14, 19 pin)</b></p> | <b>BKFD 19</b>     | <b>BSFD 19</b>   | Nickel plated brass, solder cup, accepts up to 19x24 AWG conductors, 95 °C, 30 V, 3 A, mates with Picofast junction boxes, rear mount    | <p><b>Male</b></p>   |

We reserve the right to make technical alterations without prior notice.

## 5 - 8 Pin Field Wireable, In-line Connectors

- For use with Custom Wiring or Junction Boxes
- IEC IP67 Protection



| Connector Style | Female Part Number | Male Part Number | Features   | Pinout                                  |
|-----------------|--------------------|------------------|--|---|
|                 | <b>BK 5-0</b>      | <b>BS 5-0</b>    | Nylon PG 9 cable gland, accepts 6-8 mm cable diameter, solder cup, accepts up to 5x18 AWG conductors, 85 °C, 60 VAC/DC, 6 A, Mates with 5-pin cordsets and receptacles | <p><b>Female</b></p> <p><b>Male</b></p> |
|                 | <b>BK 6-0</b>      | <b>BS 6-0</b>    | Nylon PG 9 cable gland, accepts 6-8 mm cable diameter, solder cup, accepts up to 6x18 AWG conductors, 85 °C, 60 VAC/DC, 3 A, Mates with 6-pin cordsets and receptacles | <p><b>Female</b></p> <p><b>Male</b></p> |
|                 | <b>BK 7-0</b>      | <b>BS 7-0</b>    | Nylon PG 9 cable gland, accepts 6-8 mm cable diameter, solder cup, accepts up to 7x18 AWG conductors, 85 °C, 60 VAC/DC, 3 A, Mates with 7-pin cordsets and receptacles | <p><b>Female</b></p> <p><b>Male</b></p> |
|                 | <b>BK 8-0</b>      | <b>BS 8-0</b>    | Nylon PG 9 cable gland, accepts 6-8 mm cable diameter, solder cup, accepts up to 8x18 AWG conductors, 85 °C, 60 VAC/DC, 3 A, Mates with 8-pin cordsets and receptacles | <p><b>Female</b></p> <p><b>Male</b></p> |

We reserve the right to make technical alterations without prior notice.

Accessories

## 12-pin Field Wireable, In-line Connectors

- Standard Nylon and Shielded
- IEC IP67 Protection



| Connector Style                           | Female Part Number | Male Part Number | Features   | Pinout               |
|---|--------------------|------------------|--|----------------------|
| <p><b>BK ..</b></p> <p><b>BS ..</b></p>   | <b>BK 12-0</b>     | <b>BS 12-0</b>   | Nylon PG 9 cable gland, accepts 6-8 mm cable diameter solder cup, accepts up to 12x24 AWG conductors, 85 °C, 60 VDC/VAC, 3 A, mates with 12-pin cordsets and receptacles | <p><b>Female</b></p> |
| <p><b>BKS ..</b></p> <p><b>BSS ..</b></p> | <b>BKS 12-0</b>    | <b>BSS 12-0</b>  |  |                      |

We reserve the right to make technical alterations without prior notice.

14 and 19-Pin Field Wireable, In-line Connectors

- Male Connectors
- For use with Custom Wiring or Junction Boxes
- IEC IP67 Protection



| Connector Style      | Female Part Number | Male Part Number | Features  | Pinout                                  |
|----------------------|--------------------|------------------|---|---|
| <p><b>BK ..</b></p>  | <b>BK 14-0</b>     | <b>BS 14-0</b>   | Nylon PG 9 cable gland, accepts 6-8 mm cable diameter, solder cup, accepts up to 14x24 AWG conductors, 85 °C, 60 VAC/DC, 3 A, Mates with Picofast® junction boxes, unshielded | <p><b>Female</b></p> <p><b>Male</b></p> |
| <p><b>BS ..</b></p>  | <b>BK 19-0</b>     | <b>BS 19-0</b>   | Nylon PG 9 cable gland, accepts 6-8 mm cable diameter, solder cup, accepts up to 19x24 AWG conductors, 85 °C, 60 VAC/DC, 3 A, Mates with Picofast junction boxes, unshielded  | <p><b>Female</b></p> <p><b>Male</b></p> |
| <p><b>WBK ..</b></p> | <b>WBK 14-0</b>    | <b>WBS 14-0</b>  | Nylon PG 9 cable gland, accepts 6-8 mm cable diameter, solder cup, accepts up to 14x24 AWG conductors, 85 °C, 60 VAC/DC, 3 A, Mates with Picofast junction boxes, unshielded  | <p><b>Female</b></p> <p><b>Male</b></p> |
| <p><b>WBS ..</b></p> | <b>WBK 19-0</b>    | <b>WBS 19-0</b>  | Nylon PG 9 cable gland, accepts 6-8 mm cable diameter, solder cup, accepts up to 19x24 AWG conductors, 85 °C, 60 VAC/DC, 3 A, Mates with Picofast junction boxes, unshielded  | <p><b>Male</b></p>                      |

We reserve the right to make technical alterations without prior notice.

Accessories



| Connector Style | Part Number    | Features   |
|-----------------|----------------|--|
|                 | <b>BKK-CC</b>  | Nylon, M16 threads, 4 1/2 inch plastic lanyard and 3/4 inch loop, mates to male cordsets, receptacles, or junction boxes   |
|                 | <b>BKFK-CC</b> | Nylon, M16 threads, 2 3/4 inch plastic lanyard and #10 eye-let, mates to male cordsets, receptacles, or junction boxes     |
|                 | <b>BSK-CC</b>  | Nylon, M16 threads, 4 1/2 inch plastic lanyard and 3/4 inch loop, mates to female cordsets, receptacles, or junction boxes |
|                 | <b>BSFK-CC</b> | Nylon, M16 threads, 2 3/4 inch plastic lanyard and #10 eye-let, mates to female cordsets, receptacles, or junction boxes   |
|                 | <b>BKM-CC</b>  | Nickel plated brass, M16 threads, 6" lanyard, mates with male cordsets and receptacles                                     |
|                 | <b>BKF-CC</b>  | Nickel plated brass, M16 threads, 6" lanyard with eyelet, mates with male cordsets and receptacles                         |
|                 | <b>BKM-MC</b>  | Nickel plated brass, M16 threads, no lanyard, mates with male cordsets and receptacles                                     |
|                 | <b>BSM-CC</b>  | Nickel plated brass, M16 threads, 6" lanyard   |
|                 | <b>BSF-CC</b>  | Nickel plated brass, M16 threads, 6" lanyard with eyelet   |
|                 | <b>BSM-MC</b>  | Nickel plated brass, M16 threads, no lanyard   |

We reserve the right to make technical alterations without prior notice.



|                         |            |
|-------------------------|------------|
| <b>Part Number Keys</b> | <b>H2</b>  |
| <b>Cordsets</b>         | <b>H5</b>  |
| <b>Receptacles</b>      | <b>H19</b> |
| <b>Field Wireables</b>  | <b>H32</b> |
| <b>Conduit Adapters</b> | <b>H35</b> |
| <b>Accessories</b>      | <b>H36</b> |

**Features**

- M23 and M27 threaded connectors
- M23 available in 12, 16 and 19-pin
- M27 available in 26 and 28-pin
- Up to 9 Amps, 300 Volts rated
- High density
- IEC IP67 protection



## Cordset Part Number key

Part Number Keys are to assist in IDENTIFICATION ONLY. Consult factory for catalog items not identified.

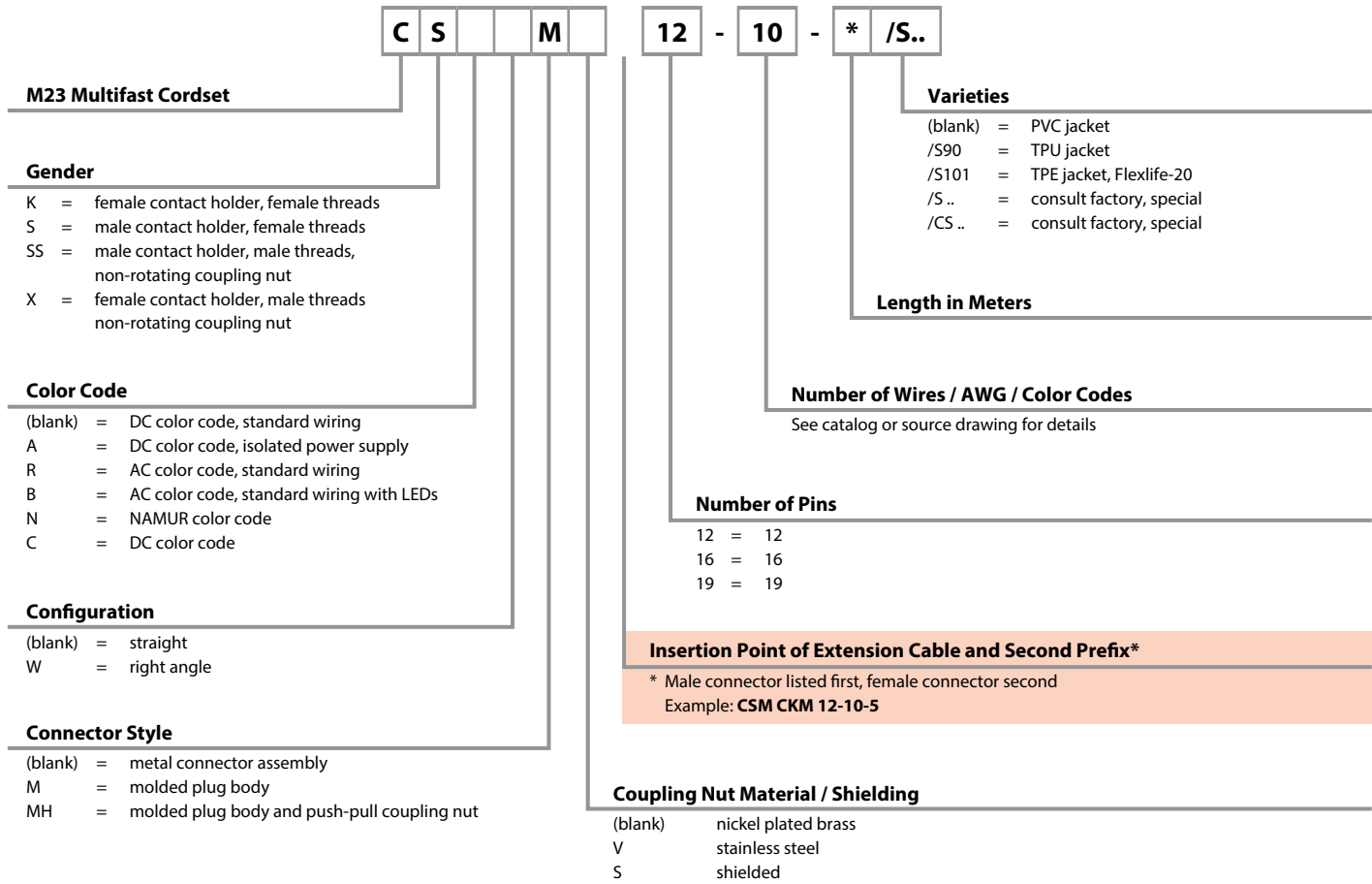

### Extension Examples

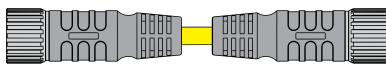

C S M C K M 12 - 10 - 5 /S..

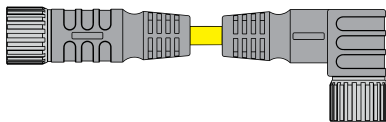

C K M C K W M 12 - 10 - 5 /S..

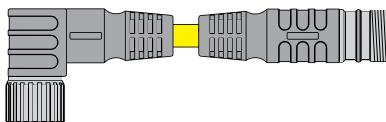

C K W M C S S M 12 - 10 - 5 /S..

Receptacle Part Number Key

Part Number Keys are to assist in IDENTIFICATION ONLY. Consult factory for catalog items not identified.

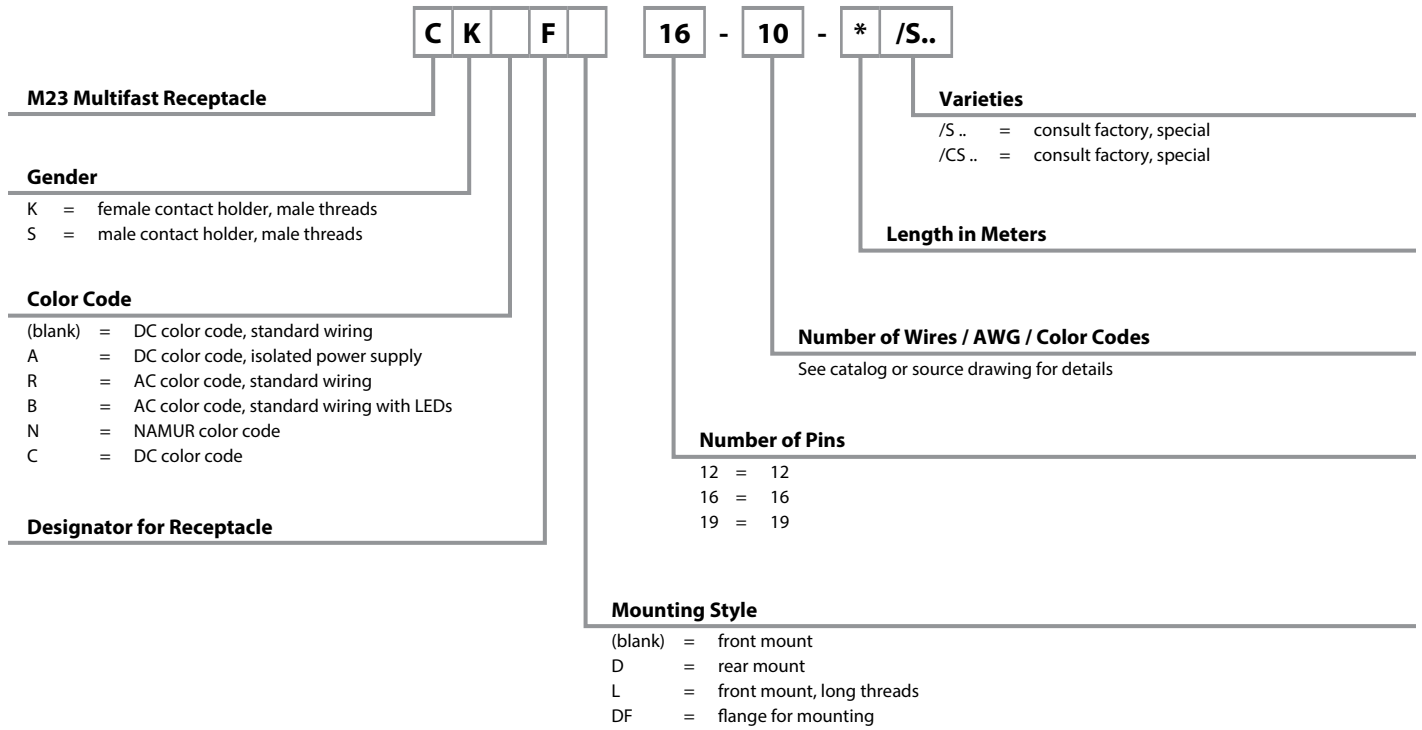

## Cordset Part Number Key

Part Number Keys are to assist in IDENTIFICATION ONLY. Consult factory for catalog items not identified.



### M27 Multifast Cordset

#### Gender

- K = female contact holder, female threads
- S = male contact holder, female threads
- SS = male contact holder, male threads  
non-rotating coupling nut

#### Connector Style

- (blank) = metal connector assembly
- M = Dmolded plug body

#### Insertion Point of Extension Cable and Second Prefix\*

- \* Male connector listed first, female connector second
- Example: **DSM DKM 26-631-5**

#### Varieties

- /S.. = consult factory, special
- /CS.. = consult factory, special

#### Length in Meters

#### Number of Wires / AWG / Color Codes

- 631 (for 26-pin) = 25x22 AWG, 1x22 AWG drain
- 061 (for 28-pin) = 27x22 AWG, 1x22 AWG drain
- 381 (for 26-pin) = 25x22 AWG, 1x24 AWG drain, braided shield

#### Number of Pins

- 26 = 26
- 28 = 28

## Receptacle Part Number Key

Part Number Keys are to assist in IDENTIFICATION ONLY. Consult factory for catalog items not identified.



### M27 Multifast Cordset

#### Gender

- K = female contact holder, male threads
- S = male contact holder, male threads

#### Designator for Receptacle

#### Varieties

- /S.. = consult factory, special
- /CS.. = consult factory, special

#### Length in Meters

#### Number of Wires

- 25 = 25 (for 26-pin)
- 27 = 27 (for 28-pin)

#### Number of Pins

- 26 = 26
- 28 = 28

## 12-Pin Cordsets, DC Color Code, Standard Wiring

- For Eurofast® Junction Boxes and Multi-Conductor Applications
- IEC IP67 Protection
- 300 V, 6 A



| Connector Style       | Female Part Number                                  | Male Part Number                                    | Features   | Pinout               |                    |
|-----------------------|---|---|--|----------------------|--------------------|
| <p><b>CKM ..</b></p>  | <b>CKM 12-7-*</b><br><b>CKWM 12-7-*</b>             | <b>CSM 12-7-*</b><br><b>CSWM 12-7-*</b>             | ITC/PLTC PVC Yellow, 7x18 AWG, 105 °C, 8.4 mm OD, Cable #RF50637- <i>*M</i> , 4 port, 1 signal per port, Flexlife®               | <p><b>Female</b></p> |                    |
|                       | <b>CKM 12-7-*/S90</b><br><b>CKWM 12-7-*/S90</b>     | <b>CSM 12-7-*/S90</b><br><b>CSWM 12-7-*/S90</b>     | AWM TPU Yellow, 7x18 AWG, 90 °C, 6.7 mm OD, Cable #RF50676- <i>*M</i> , 4 port, 1 signal per port, Cut/Abrasion Immune           |                      |                    |
| <p><b>CKWM..</b></p>  | <b>CKM 12-9-*</b><br><b>CKWM 12-9-*</b>             | <b>CSM 12-9-*</b><br><b>CSWM 12-9-*</b>             | ITC/PLTC PVC Yellow, 9x18 AWG, 105 °C, 9.6 mm OD, Cable #RF50636- <i>*M</i> , 6 port, 1 signal per port, Flexlife                |                      |                    |
|                       | <b>CKM 12-9-*/S90</b><br><b>CKWM 12-9-*/S90</b>     | <b>CSM 12-9-*/S90</b><br><b>CSWM 12-9-*/S90</b>     | AWM TPU Yellow, 9x18 AWG, 90 °C, 9.6 mm OD, Cable #RF50677- <i>*M</i> , 6 port, 1 signal per port, Cut/Abrasion Immune           |                      |                    |
| <p><b>CSM ..</b></p>  | <b>CKM 12-11-*</b><br><b>CKWM 12-11-*</b>           | <b>CSM 12-11-*</b><br><b>CSWM 12-11-*</b>           | ITC/PLTC PVC Yellow, 11x18 AWG, 105 °C, 10.5 mm OD, Cable #RF51088- <i>*M</i> , 8 port, 1 signal per port, Flexlife              |                      | <p><b>Male</b></p> |
|                       | <b>CKM 12-11-*/S90</b><br><b>CKWM 12-11-*/S90</b>   | <b>CSM 12-11-*/S90</b><br><b>CSWM 12-11-*/S90</b>   | AWM TPU Yellow, 11x18 AWG, 90 °C, 10 mm OD, Cable #RF50678- <i>*M</i> , 8 port, 1 signal per port, Cut/Abrasion Immune           |                      |                    |
| <p><b>CSWM ..</b></p> | <b>CKM 12-12-*/S101</b><br><b>CKWM 12-12-*/S101</b> | <b>CSM 12-12-*/S101</b><br><b>CSWM 12-12-*/S101</b> | AWM TPE Yellow, 12x18 AWG, 105 °C, 11.2 mm OD, Cable #RF50915- <i>*M</i> 8 port, Flexlife-20, High Flex - Over 20 million cycles |                      |                    |
|                       | <b>CKM 12-12-*/S817</b><br><b>CKWM 12-12-*/S817</b> | <b>CSM 12-12-*/S817</b><br><b>CSWM 12-12-*/S817</b> | ITC/PLTC PVC Yellow, 12x18 AWG, 105 °C, 11.2 mm OD, Cable #RF50606- <i>*M</i> , Flexlife   |                      |                    |

We reserve the right to make technical alterations without prior notice.

Cordsets

\* Length in meters.  
 Standard cable lengths are 5 and 10 meters. Consult factory for other lengths.  
 Standard coupling nut material is nickel plated brass.. "CKM.."; "CKMV.." indicates stainless steel coupling nut.

- For Eurofast® Junction Boxes and Multi-Conductor Applications
- IEC IP67 Protection
- 300 V, 6 A



| Connector Style   | Male Part Number   | Features  | Pinout  |
|---|--|---|---|
| <p><b>CSSM ..</b></p> <p>3.335 [84.7]</p> <p>0.929 [23.6]</p> <p>M23x1</p> <p>Non-rotating coupling nut</p><br><p><b>CSSWM ..</b></p> <p>2.887 [73.3]</p> <p>2.049 [52.0]</p> <p>M23x1</p> <p>0.929 [23.6]</p> <p>Non-rotating coupling nut</p> | <b>CSSM 12-7-*</b><br><b>CSSWM 12-7-*</b>  | ITC/PLTC PVC Yellow, 7x18 AWG, 105 °C, 8.4 mm OD, Cable #RF50637-*M, 4 port, 1 signal per port, Flexlife®               | 1. BN<br>3. BU<br>4. WH<br>6. GN<br>7. YE<br>8. GY<br>12. GN/YE   |
|   | <b>CSSM 12-7-*/S90</b><br><b>CSSWM 12-7-*/S90</b>  | AWM TPU Yellow, 7x18 AWG, 90 °C, 6.7 mm OD, Cable #RF50676-*M, 4 port, 1 signal per port, Cut/Abrasion Immune           | 1. BN<br>3. BU<br>4. WH<br>6. GN<br>7. YE<br>8. GY<br>12. GN/YE   |
|   | <b>CSSM 12-9-*</b><br><b>CSSWM 12-9-*</b>  | ITC/PLTC PVC Yellow, 9x18 AWG, 105 °C, 9.6 mm OD, Cable #RF50636-*M, 6 port, 1 signal per port, Flexlife                | 1. BN<br>3. BU<br>4. WH<br>6. GN<br>7. YE<br>8. GY<br>9. PK<br>10. RD<br>12. GN/YE                                      |
|   | <b>CSSM 12-9-*/S90</b><br><b>CSSWM 12-9-*/S90</b>  | AWM TPU Yellow, 9x18 AWG, 90 °C, 9.6 mm OD, Cable #RF50677-*M, 6 port, 1 signal per port, Cut/Abrasion Immune           | 1. BN<br>3. BU<br>4. WH<br>5. GN<br>6. YE<br>7. GY<br>8. PK<br>9. RD<br>10. BK<br>11. VT<br>12. GN/YE                   |
|   | <b>CSSM 12-11-*</b><br><b>CSSWM 12-11-*</b>  | ITC/PLTC PVC Yellow, 11x18 AWG, 105 °C, 10.5 mm OD, Cable #RF51088-*M, 8 port, 1 signal per port, Flexlife              | 1. BN<br>2. BU<br>3. WH<br>4. GN/YE<br>5. OG<br>6. YE<br>7. GY<br>8. PK<br>9. RD<br>10. BN/WH<br>11. BU/WH<br>12. GN/WH |
|   | <b>CSSM 12-11-*/S90</b><br><b>CSSWM 12-11-*/S90</b>  | AWM TPU Yellow, 11x18 AWG, 90 °C, 10 mm OD, Cable #RF50678-*M, 8 port, 1 signal per port, Cut/Abrasion Immune           | 1. BN<br>2. BU<br>3. WH<br>4. GN/YE<br>5. OG<br>6. YE<br>7. GY<br>8. PK<br>9. RD<br>10. BN/WH<br>11. BU/WH<br>12. GN/WH |
| <b>CSSM 12-12-*/S101</b><br><b>CSSWM 12-12-*/S101</b>   | AWM TPE Yellow, 12x18 AWG, 105 °C, 11.2 mm OD, Cable #RF50915-*M 8 port, Flexlife-20, High Flex - Over 20 million cycles | 1. BN<br>2. BU<br>3. WH<br>4. GN/YE<br>5. OG<br>6. YE<br>7. GY<br>8. PK<br>9. RD<br>10. BN/WH<br>11. BU/WH<br>12. GN/WH |   |
| <b>CSSM 12-12-*/S817</b><br><b>CSSWM 12-12-*/S817</b>   | ITC/PLTC PVC Yellow, 12x18 AWG, 105 °C, 11.2 mm OD, Cable #RF50606-*M, Flexlife  | 1. BN<br>2. BU<br>3. WH<br>4. GN/YE<br>5. OG<br>6. YE<br>7. GY<br>8. PK<br>9. RD<br>10. BN/WH<br>11. BU/WH<br>12. GN/WH |   |

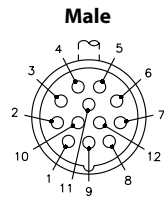

We reserve the right to make technical alterations without prior notice.

\* Length in meters.  
 Standard cable lengths are 5 and 10 meters. Consult factory for other lengths.  
 Standard coupling nut material is nickel plated brass.. "CSSM..".

19-Pin Cordsets, DC Color Code, Standard Wiring

- For Eurofast® Junction Boxes and Multi-Conductor Applications
- IEC IP67 Protection
- 150 V, 9 A (18 AWG) & 2 A (22 AWG)



We reserve the right to make technical alterations without prior notice.

| Connector Style       | Female Part Number                                  | Male Part Number                                    | Features  | Pinout               |
|-----------------------|---|---|---|----------------------|
| <p><b>CKM ..</b></p>  | <b>CKM 19-11-*</b><br><b>CKWM 19-11-*</b>           | <b>CSM 19-11-*</b><br><b>CSWM 19-11-*</b>           | ITC/PLTC PVC Yellow, 3x18, 8x22 AWG, 105 °C, 8.5 mm OD, Cable #RF50624-*M, 4-port, 2 signals per port, Flexlife®                                    | <p><b>Female</b></p> |
|                       | <b>CKM 19-11-*/S90</b><br><b>CKWM 19-11-*/S90</b>   | <b>CSM 19-11-*/S90</b><br><b>CSWM 19-11-*/S90</b>   | AWM TPU Yellow, 3x18, 8x22 AWG, 90 °C, 8.4 mm OD, Cable #RF50718-*M, 4-port, 2 signals per port, Cut/Abrasion Immune                                |                      |
| <p><b>CKWM ..</b></p> | <b>CKM 19-15-*</b><br><b>CKWM 19-15-*</b>           | <b>CSM 19-15-*</b><br><b>CSWM 19-15-*</b>           | ITC/PLTC PVC Yellow, 3x18, 12x22 AWG, 105 °C, 8.5 mm OD, Cable #RF50625-*M, 6-port, 2 signals per port, Flexlife                                    | <p><b>Male</b></p>   |
|                       | <b>CKM 19-15-*/S90</b><br><b>CKWM 19-15-*/S90</b>   | <b>CSM 19-15-*/S90</b><br><b>CSWM 19-15-*/S90</b>   | AWM TPU Yellow, 3x18, 12x22 AWG, 90 °C, 8.4 mm OD, Cable #RF50818-*M, 6-port, 2 signals per port, Cut/Abrasion Immune                               |                      |
| <p><b>CSM ..</b></p>  | <b>CKM 19-19-*</b><br><b>CKWM 19-19-*</b>           | <b>CSM 19-19-*</b><br><b>CSWM 19-19-*</b>           | ITC/PLTC PVC Yellow, 3x18, 16x22 AWG, 105 °C, 10.0 mm OD, Cable #RF50620-*M, 8 port, 2 signals per port, Flexlife                                   | <p><b>Female</b></p> |
|                       | <b>CKM 19-19-*/S90</b><br><b>CKWM 19-19-*/S90</b>   | <b>CSM 19-19-*/S90</b><br><b>CSWM 19-19-*/S90</b>   | AWM TPU Yellow, 3x18, 16x22 AWG, 90 °C, 10.0 mm OD, Cable #RF50682-*M, 8 port, 2 signals per port Cut/Abrasion Immune                               |                      |
| <p><b>CSWM ..</b></p> | <b>CKM 19-19-*/S101</b><br><b>CKWM 19-19-*/S101</b> | <b>CSM 19-19-*/S101</b><br><b>CSWM 19-19-*/S101</b> | AWM TPE Yellow, 3x18, 16x22 AWG, 105 °C, 11.2 mm OD, Cable #RF50916-*M, 8 port, 2 signals per port, Flexlife-20, High Flex - Over 20 million cycles | <p><b>Male</b></p>   |

\* Length in meters.  
 Standard cable lengths are 5 and 10 meters. Consult factory for other lengths.  
 Standard coupling nut material is nickel plated brass.. "CKM.."; "CKMV.." indicates stainless steel coupling nut.

Cordsets

- For Eurofast® Junction Boxes and Multi-Conductor Applications
- IEC IP67 Protection
- 150 V, 9 A (18 AWG) & 2 A (22 AWG)



| Connector Style   | Male Part Number                                      | Features  | Pinout   |
|---|---|---|--|
| <p><b>CSSM ..</b></p> <p>Non-rotating coupling nut</p>  | <b>CSSM 19-11-*</b><br><b>CSSWM 19-11-*</b>           | ITC/PLTC PVC Yellow, 3x18, 8x22 AWG, 105 °C, 8.5 mm OD, Cable #RF50624-*M, 4-port, 2 signals per port, Flexlife®                                    | 3. GY<br>4. RD/BU<br>5. GN<br>6. BU<br>7. GY/PK<br>8. WH/GN<br>12. GN/YE<br>14. BN/GN<br>15. WH<br>16. YE<br>19. BN  |
|   | <b>CSSM 19-11-*/S90</b><br><b>CSSWM 19-11-*/S90</b>   | AWM TPU Yellow, 3x18, 8x22 AWG, 90 °C, 8.4 mm OD, Cable #RF50718-*M, 4-port, 2 signals per port, Cut/Abrasion Immune                                | 2. RD<br>3. GY<br>4. RD/BU<br>5. GN<br>6. BU<br>7. GY/PK<br>8. WH/GN<br>9. WH/YE<br>12. GN/YE<br>13. YE/BN<br>14. BN/GN<br>15. WH<br>16. YE<br>17. PK<br>19. BN  |
| <p><b>CSSWM ..</b></p> <p>Non-rotating coupling nut</p> | <b>CSSM 19-15-*</b><br><b>CSSWM 19-15-*</b>           | ITC/PLTC PVC Yellow, 3x18, 12x22 AWG, 105 °C, 8.5 mm OD, Cable #RF50625-*M, 6-port, 2 signals per port, Flexlife                                    | <p><b>Male</b></p>   |
|   | <b>CSSM 19-15-*/S90</b><br><b>CSSWM 19-15-*/S90</b>   | AWM TPU Yellow, 3x18, 12x22 AWG, 90 °C, 8.4 mm OD, Cable #RF50818-*M, 6-port, 2 signals per port, Cut/Abrasion Immune                               |  |
|   | <b>CSSM 19-19-*</b><br><b>CSSWM 19-19-*</b>           | ITC/PLTC PVC Yellow, 3x18, 16x22 AWG, 105 °C, 10.0 mm OD, Cable #RF50620-*M, 8 port, 2 signals per port, Flexlife                                   |  |
|   | <b>CSSM 19-19-*/S90</b><br><b>CSSWM 19-19-*/S90</b>   | AWM TPU Yellow, 3x18, 16x22 AWG, 90 °C, 10.0 mm OD, Cable #RF50682-*M, 8 port, 2 signals per port Cut/Abrasion Immune                               |  |
|   | <b>CSSM 19-19-*/S101</b><br><b>CSSWM 19-19-*/S101</b> | AWM TPE Yellow, 3x18, 16x22 AWG, 105 °C, 11.2 mm OD, Cable #RF50916-*M, 8 port, 2 signals per port, Flexlife-20, High Flex - Over 20 million cycles | 1. VT<br>2. RD<br>3. GY<br>4. RD/BU<br>5. GN<br>6. BU<br>7. GY/PK<br>8. WH/GN<br>9. WH/YE<br>10. WH/GY<br>11. BK<br>12. GN/YE<br>13. YE/BN<br>14. BN/GN<br>15. WH<br>16. YE<br>17. PK<br>18. GY/BN<br>19. BN |

We reserve the right to make technical alterations without prior notice.

\* Length in meters.  
 Standard cable lengths are 5 and 10 meters. Consult factory for other lengths.  
 Standard coupling nut material is nickel plated brass.. "CSSM..".



## 12 and 19-Pin Shielded Cordsets, DC Color Code, Standard Wiring

- Shield to Coupling Nut
- For Eurofast® Junction Boxes and Multi-Conductor Applications
- IEC IP67 Protection



| Connector Style        | Female Part Number  | Male Part Number  | Features   | Pinout   |
|------------------------|---|---|--|--|
| <p><b>CKMS ..</b></p>  | <p><b>CKMS 12-7-204-*</b><br/><b>CKWMS 12-7-204-*</b></p>   | <p><b>CSMS 12-7-204-*</b><br/><b>CSWMS 12-7-204-*</b></p>   | <p>ITC/PLTC PVC Yellow, 7x18 AWG, 105 °C, 300 V, 6 A, 8.4 mm OD, Cable #RF51204-*M<br/>4-port, 1 signal per port, EMI/RFI Protection</p>                               | <p>1. BN 7. YE<br/>2. N/C 8. GY<br/>3. BU 9. N/C<br/>4. WH 10. N/C<br/>5. N/C 11. N/C<br/>6. GN 12. GN/YE</p> <p style="text-align: center;"><b>Female</b></p>   |
| <p><b>CKWMS ..</b></p> | <p><b>CKMS 12-11-190-*</b><br/><b>CKWMS 12-11-190-*</b></p> | <p><b>CSMS 12-11-190-*</b><br/><b>CSWMS 12-11-190-*</b></p> | <p>ITC/PLTC PVC Yellow, 11x18 AWG, 105 °C, 300 V, 6 A, 11.2 mm OD, Cable #RF51190-*M,<br/>8-port, 1 signal per port, EMI/RFI Protection</p>                            | <p>1. BN 7. GY<br/>2. N/C 8. PK<br/>3. BU 9. RD<br/>4. WH 10. BK<br/>5. GN 11. VT<br/>6. YE 12. GN/YE</p> <p style="text-align: center;"><b>Male</b></p>   |
| <p><b>CSMS ..</b></p>  | <p><b>CKMS 19-191-*</b><br/><b>CKWMS 19-191-*</b></p>       | <p><b>CSMS 19-191-*</b><br/><b>CSWMS 19-191-*</b></p>       | <p>PLTC PVC Yellow, 3x18, 16x22 AWG, 105 °C, 150 V, 9 A (18 AWG) &amp; 2 A (22 AWG), 11.2 mm OD, Cable #RF51191-*M, 8 port, 2 signals per port, EMI/RFI Protection</p> | <p>1. VT<br/>2. RD<br/>3. GY<br/>4. RD/BU<br/>5. GN<br/>6. BU<br/>7. GY/PK<br/>8. WH/GN<br/>9. WH/YE<br/>10. WH/GY<br/>11. BK<br/>12. GN/YE<br/>13. YE/BN<br/>14. BN/GN<br/>15. WH<br/>16. YE<br/>17. PK<br/>18. GY/BN<br/>19. BN</p> <p style="text-align: center;"><b>Female</b></p> |
| <p><b>CSWMS ..</b></p> | <p><b>CKMS 19-191-*</b><br/><b>CKWMS 19-191-*</b></p>       | <p><b>CSMS 19-191-*</b><br/><b>CSWMS 19-191-*</b></p>       | <p>PLTC PVC Yellow, 3x18, 16x22 AWG, 105 °C, 150 V, 9 A (18 AWG) &amp; 2 A (22 AWG), 11.2 mm OD, Cable #RF51191-*M, 8 port, 2 signals per port, EMI/RFI Protection</p> | <p>1. VT<br/>2. RD<br/>3. GY<br/>4. RD/BU<br/>5. GN<br/>6. BU<br/>7. GY/PK<br/>8. WH/GN<br/>9. WH/YE<br/>10. WH/GY<br/>11. BK<br/>12. GN/YE<br/>13. YE/BN<br/>14. BN/GN<br/>15. WH<br/>16. YE<br/>17. PK<br/>18. GY/BN<br/>19. BN</p> <p style="text-align: center;"><b>Male</b></p>   |

We reserve the right to make technical alterations without prior notice.

Cordsets

\* Length in meters.  
Standard cable lengths are 5 and 10 meters. Consult factory for other lengths.  
Standard coupling nut material is nickel plated brass. "CKMS.."; "CKMSV.." indicates stainless steel coupling nut.

- For Eurofast® Junction Boxes and Multi-Conductor Applications
- IEC IP67 Protection
- 150 V, 6 A



| Connector Style        | Female Part Number                          | Male Part Number                            | Features  | Pinout  |
|------------------------|---|---|---|---|
| <p><b>CKAM ..</b></p>  | <b>CKAM 16-10-*</b><br><b>CKAWM 16-10-*</b> | <b>CSAM 16-10-*</b><br><b>CSAWM 16-10-*</b> | ITC/PLTC PVC Yellow, 10x18 AWG, 105 °C, 10.8 mm OD, Cable #RF50607-*M, 4-port, dual supply, Flexlife® | <ol style="list-style-type: none"> <li>1. BN</li> <li>3. BU</li> <li>4. WH</li> <li>5. GN/YE</li> <li>6. OG</li> <li>7. YE</li> <li>8. GY</li> <li>11. BN/WH</li> <li>13. BU/WH</li> <li>15. GN/WH</li> </ol> <p style="text-align: center;"><b>Female</b></p>  |
| <p><b>CKAWM ..</b></p> | <b>CKAM 16-12-*</b><br><b>CKAWM 16-12-*</b> | <b>CSAM 16-12-*</b><br><b>CSAWM 16-12-*</b> | ITC/PLTC PVC Yellow, 12x18 AWG, 105 °C, 11.2 mm OD, Cable #RF50606-*M, 6-port, dual supply, Flexlife  | <ol style="list-style-type: none"> <li>1. BN</li> <li>3. BU</li> <li>4. WH</li> <li>5. GN/YE</li> <li>6. OG</li> <li>7. YE</li> <li>8. GY</li> <li>9. PK</li> <li>10. RD</li> <li>11. BN/WH</li> <li>13. BU/WH</li> <li>15. GN/WH</li> </ol> <p style="text-align: center;"><b>Female</b></p>                               |
| <p><b>CSAM ..</b></p>  | <b>CKAM 16-14-*</b><br><b>CKAWM 16-14-*</b> | <b>CSAM 16-14-*</b><br><b>CSAWM 16-14-*</b> | ITC/PLTC PVC Yellow, 14x18 AWG, 105 °C, 11.5 mm OD, Cable #RF50576-*M, 8-port, dual supply, Flexlife  | <ol style="list-style-type: none"> <li>1. BN</li> <li>3. BU</li> <li>4. WH</li> <li>5. GN/YE</li> <li>6. OG</li> <li>7. YE</li> <li>8. GY</li> <li>9. PK</li> <li>10. RD</li> <li>11. BN/WH</li> <li>12. BK</li> <li>13. BU/WH</li> <li>14. VT</li> <li>15. GN/WH</li> </ol> <p style="text-align: center;"><b>Male</b></p> |
| <p><b>CSAWM ..</b></p> |   |   |   |   |

We reserve the right to make technical alterations without prior notice.

\* Length in meters.  
Standard cable lengths are 5 and 10 meters. Consult factory for other lengths.  
Standard coupling nut material is nickel plated brass.. "CKAM.."; "CKAMV.." indicates stainless steel coupling nut.

## 16-Pin Connectors, DC Color Code, Isolated Power Supply

- For Eurofast® Junction Boxes and Multi-Conductor Applications
- IEC IP67 Protection
- 150 V, 6 A



| Connector Style   | Male Part Number                              | Features  | Pinout   |
|---|---|---|--|
| <p><b>CSSAM ..</b></p> <p>Non-rotating coupling nut</p> | <b>CSSAM 16-10-*</b><br><b>CSSAWM 16-10-*</b> | ITC/PLTC PVC Yellow, 10x18 AWG, 105 °C, 10.8 mm OD, Cable #RF50607-*M, 4-port, dual supply, Flexlife® | 1. BN<br>3. BU<br>4. WH<br>5. GN/YE<br>6. OG<br>7. YE<br>8. GY<br>11. BN/WH<br>13. BU/WH<br>15. GN/WH  |
|   | <b>CSSAM 16-12-*</b><br><b>CSSAWM 16-12-*</b> | ITC/PLTC PVC Yellow, 12x18 AWG, 105 °C, 11.2 mm OD, Cable #RF50606-*M, 6-port, dual supply, Flexlife  | 1. BN<br>3. BU<br>4. WH<br>5. GN/YE<br>6. OG<br>7. YE<br>8. GY<br>9. PK<br>10. RD<br>11. BN/WH<br>13. BU/WH<br>15. GN/WH                     |
|   | <b>CSSAM 16-14-*</b><br><b>CSSAWM 16-14-*</b> | ITC/PLTC PVC Yellow, 14x18 AWG, 105 °C, 11.5 mm OD, Cable #RF50576-*M, 8-port, dual supply, Flexlife  | 1. BN<br>3. BU<br>4. WH<br>5. GN/YE<br>6. OG<br>7. YE<br>8. GY<br>9. PK<br>10. RD<br>11. BN/WH<br>12. BK<br>13. BU/WH<br>14. VT<br>15. GN/WH |

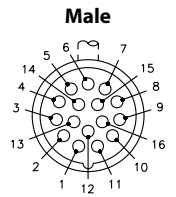

Cordsets

We reserve the right to make technical alterations without prior notice.

\* Length in meters.  
 Standard cable lengths are 5 and 10 meters. Consult factory for other lengths.  
 Standard coupling nut material is nickel plated brass.. "CSSAM..".

## 12-Pin Cordsets, AC & DC Color Code

- For Eurofast®, Minifast®, and Microfast® Junction Boxes and Multi-Conductor Applications
- IEC IP67 Protection
- 300 V, 6 A



| Connector Style       | Female Part Number                                  | Male Part Number                                    | Features   | Pinout  |
|-----------------------|---|---|--|---|
| <p><b>CK*M..</b></p>  | <b>CKBM 12-7-*</b><br><b>CKBWM 12-7-*</b>           | <b>CSBM 12-7-*</b><br><b>CSBWM 12-7-*</b>           | ITC/PLTC PVC Black, 7x18 AWG, 105 °C, 8.4 mm OD, Cable #RF50715-*M, 4-port, AC Color Code, Standard Wiring with LEDs, Flexlife®  | 1. WH/BK<br>2. BK<br>3. WH<br>4. RD<br>5. OG<br>6. BU<br>7. GN  |
|                       | <b>CKBM 12-11-*</b><br><b>CKBWM 12-11-*</b>         | <b>CSBM 12-11-*</b><br><b>CSBWM 12-11-*</b>         | ITC/PLTC PVC Black, 11x18 AWG, 105 °C, 10.8 mm OD, Cable #RF50716-*M, 8-port, AC Color Code, Standard Wiring with LEDs, Flexlife | 1. OG<br>2. BU<br>3. WH/BK<br>4. RD/BK<br>5. GN/BK<br>6. OG/BK<br>7. BU/BK<br>9. GN<br>10. RD<br>11. WH<br>12. BK |
| <p><b>CK*WM..</b></p> | <b>CKCM 12-9-*</b><br><b>CKCWM 12-9-*</b>           | <b>CSCM 12-9-*</b><br><b>CSCWM 12-9-*</b>           | ITC/PLTC PVC Yellow, 7x18 AWG, 105 °C, 8.4 mm OD, Cable #RF50637-*M, 4-port 1 signal per port, DC Color Code, Flexlife           | 1. WH<br>2. GN<br>3. YE<br>4. GY<br>5. PK<br>6. RD<br>10. BU<br>11. BN<br>12. GN/YE                               |
|                       | <b>CKCM 12-9-*/S90</b><br><b>CKCWM 12-9-*/S90</b>   | <b>CSCM 12-9-*/S90</b><br><b>CSCWM 12-9-*/S90</b>   | AWM TPU Yellow, 7x18 AWG, 90 °C, 6.7 mm OD, Cable #RF50676-*M, 4-port, 1 signal per port, DC Color Code, Cut/Abrasion Immune     |   |
| <p><b>CS*M..</b></p>  | <b>CKCM 12-11-*</b><br><b>CKCWM 12-11-*</b>         | <b>CSCM 12-11-*</b><br><b>CSCWM 12-11-*</b>         | ITC/PLTC PVC Yellow, 11x18 AWG, 105 °C, 10.5 mm OD, Cable #RF51088-*M, 8-port 1 Signal per port, DC Color Code, Flexlife         | 1. WH<br>2. GN<br>3. YE<br>4. GY<br>5. PK<br>6. RD<br>7. BK<br>8. VT<br>10. BU<br>11. BN<br>12. GN/YE             |
|                       | <b>CKCM 12-11-*/S90</b><br><b>CKCWM 12-11-*/S90</b> | <b>CSCM 12-11-*/S90</b><br><b>CSCWM 12-11-*/S90</b> | AWM TPU Yellow, 11x18 AWG, 90 °C, 10 mm OD, Cable #RF50678-*M, 8-port, 1 signal per port, DC Color Code, Cut/Abrasion Immune     |   |

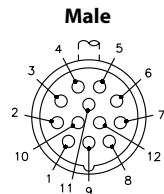
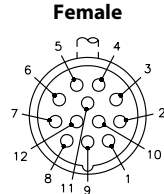

We reserve the right to make technical alterations without prior notice.

\* Length in meters.  
 Standard cable lengths are 5 and 10 meters. Consult factory for other lengths.  
 Standard coupling nut material is nickel plated brass.. "CKB(C)M.."; "CKB(C)MV.." indicates stainless steel coupling nut.

12-Pin Connectors, AC Color Code

- For Eurofast®, Minifast®, and Microfast® Junction Boxes and Multi-Conductor Applications
- IEC IP67 Protection
- 300 V, 6 A



We reserve the right to make technical alterations without prior notice.

| Connector Style   | Male Part Number  | Features   | Pinout   |
|---|---|--|--|
| <p><b>CSS*M ..</b></p> <p>3.335 [84.7]</p> <p>0.929 [23.6]</p> <p>M23x1</p> <p>Non-rotating coupling nut</p>                      | <p><b>CSSRM 12-6-*</b></p> <p><b>CSSRWM 12-6-*</b></p>  | <p>ITC/PLTC PVC Black, 6x18 AWG, 105 °C, 8.4 mm OD, Cable #RF50551-*M, 4-port, AC Color Code, Standard Wiring, Flexlife®</p>                                     | <p>1. OG</p> <p>2. BU</p> <p>4. BK</p> <p>5. WH</p> <p>6. RD</p> <p>7. GN</p>  |
|   | <p><b>CSSRM 12-8-*</b></p> <p><b>CSSRWM 12-8-*</b></p>  | <p>ITC/PLTC PVC Black, 8x18 AWG, 105 °C, 8.9 mm OD, Cable #RF50552-*M, 6-port, AC Color Code, Standard Wiring, Flexlife</p>                                      | <p>1. OG</p> <p>2. BU</p> <p>3. YE</p> <p>4. BK</p> <p>5. WH</p> <p>6. RD</p> <p>7. GN</p> <p>8. BN</p>                            |
| <p><b>CSS*WM ..</b></p> <p>2.887 [73.3]</p> <p>2.049 [52.0]</p> <p>M23x1</p> <p>0.929 [23.6]</p> <p>Non-rotating coupling nut</p> | <p><b>CSSBM 12-10-*</b></p> <p><b>CSSRWM 12-10-*</b></p>  | <p>ITC/PLTC PVC Black, 10x18 AWG, 105 °C, 10.8 mm OD, Cable #RF50553-*M, 8-port, AC Color Code, Standard Wiring, Flexlife</p>                                    | <p>1. VT</p> <p>2. BU</p> <p>3. GY</p> <p>4. BK</p> <p>5. WH</p> <p>6. RD</p> <p>7. GN</p> <p>8. YE</p> <p>9. OG</p> <p>10. BN</p> |
|   | <p><b>CSSBM 12-7-*</b></p> <p><b>CSSBWM 12-7-*</b></p>  | <p>ITC/PLTC PVC Black, 7x18 AWG, 105 °C, 8.4 mm OD, Cable #RF50715-*M, 4-port, AC Color Code, Standard Wiring with LEDs, Flexlife</p>                            | <p>1. WH/BK</p> <p>2. BK</p> <p>3. WH</p> <p>4. RD</p> <p>5. OG</p> <p>6. BU</p> <p>7. GN</p>                                      |
| <p><b>CSSBM 12-11-*</b></p> <p><b>CSSBWM 12-11-*</b></p>  | <p>ITC/PLTC PVC Black, 11x18 AWG, 105 °C, 10.8 mm OD, Cable #RF50716-*M, 8-port, AC Color Code, Standard Wiring with LEDs, Flexlife</p> | <p>1. OG</p> <p>2. BU</p> <p>3. WH/BK</p> <p>4. RD/BK</p> <p>5. GN/BK</p> <p>6. OG/BK</p> <p>7. BU/BK</p> <p>9. GN</p> <p>10. RD</p> <p>11. WH</p> <p>12. BK</p> |  |

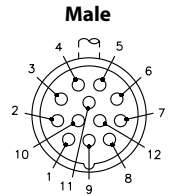

Cordsets

\* Length in meters.  
 Standard cable lengths are 5 and 10 meters. Consult factory for other lengths.  
 Standard coupling nut material is nickel plated brass.. "CSSR(B)M..".

- For Eurofast® Junction Boxes and Multi-Conductor Applications
- IEC IP67 Protection



| Connector Style                           | Female Part Number                          | Male Part Number  | Features  | Pinout   |       |       |       |        |       |        |       |        |       |           |       |           |       |           |       |           |
|---|---|---|---|--|-------|-------|-------|--------|-------|--------|-------|--------|-------|-----------|-------|-----------|-------|-----------|-------|-----------|
| <p><b>CK*M..</b></p>                      | <b>CKRM 12-6-*</b><br><b>CKRWM 12-6-*</b>   | <b>CSRM 12-6-*</b><br><b>CSRWM 12-6-*</b>   | ITC/PLTC PVC Black, 6x18 AWG, 105 °C, 8.4 mm OD, Cable #RF50551-*M, 4-port, AC Color Code, Standard Wiring, Flexlife®   | <table border="0"> <tr> <td>1. OG</td> <td>5. WH</td> </tr> <tr> <td>2. BU</td> <td>6. RD</td> </tr> <tr> <td>4. BK</td> <td>7. GN</td> </tr> </table>   | 1. OG | 5. WH | 2. BU | 6. RD  | 4. BK | 7. GN  |       |        |       |           |       |           |       |           |       |           |
|   | 1. OG                                       | 5. WH   |   |  |       |       |       |        |       |        |       |        |       |           |       |           |       |           |       |           |
| 2. BU                                     | 6. RD                                       |   |   |  |       |       |       |        |       |        |       |        |       |           |       |           |       |           |       |           |
| 4. BK                                     | 7. GN                                       |   |   |  |       |       |       |        |       |        |       |        |       |           |       |           |       |           |       |           |
| <b>CKRM 12-8-*</b><br><b>CKRWM 12-8-*</b> | <b>CSRM 12-8-*</b><br><b>CSRWM 12-8-*</b>   | ITC/PLTC PVC Black, 8x18 AWG, 105 °C, 8.9 mm OD, Cable #RF50552-*M, 6-port, AC Color Code, Standard Wiring, Flexlife  | <table border="0"> <tr> <td>1. OG</td> <td>5. WH</td> </tr> <tr> <td>2. BU</td> <td>6. RD</td> </tr> <tr> <td>3. YE</td> <td>7. GN</td> </tr> <tr> <td>4. BK</td> <td>8. BN</td> </tr> </table>                                     | 1. OG  | 5. WH | 2. BU | 6. RD | 3. YE  | 7. GN | 4. BK  | 8. BN |        |       |           |       |           |       |           |       |           |
| 1. OG                                     | 5. WH                                       |   |   |  |       |       |       |        |       |        |       |        |       |           |       |           |       |           |       |           |
| 2. BU                                     | 6. RD                                       |   |   |  |       |       |       |        |       |        |       |        |       |           |       |           |       |           |       |           |
| 3. YE                                     | 7. GN                                       |   |   |  |       |       |       |        |       |        |       |        |       |           |       |           |       |           |       |           |
| 4. BK                                     | 8. BN                                       |   |   |  |       |       |       |        |       |        |       |        |       |           |       |           |       |           |       |           |
| <p><b>CK*WM..</b></p>                     | <b>CKRM 12-10-*</b><br><b>CKRWM 12-10-*</b> | <b>CSRM 12-10-*</b><br><b>CSRWM 12-10-*</b>   | ITC/PLTC PVC Black, 10x18 AWG, 105 °C, 10.8 mm OD, Cable #RF50553-*M, 8-port, AC Color Code, Standard Wiring, Flexlife  | <table border="0"> <tr> <td>1. VT</td> <td>6. RD</td> </tr> <tr> <td>2. BU</td> <td>7. GN</td> </tr> <tr> <td>3. GY</td> <td>8. YE</td> </tr> <tr> <td>4. BK</td> <td>9. OG</td> </tr> <tr> <td>5. WH</td> <td>10. BN</td> </tr> </table>  | 1. VT | 6. RD | 2. BU | 7. GN  | 3. GY | 8. YE  | 4. BK | 9. OG  | 5. WH | 10. BN    |       |           |       |           |       |           |
|   | 1. VT                                       | 6. RD   |   |  |       |       |       |        |       |        |       |        |       |           |       |           |       |           |       |           |
| 2. BU                                     | 7. GN                                       |   |   |  |       |       |       |        |       |        |       |        |       |           |       |           |       |           |       |           |
| 3. GY                                     | 8. YE                                       |   |   |  |       |       |       |        |       |        |       |        |       |           |       |           |       |           |       |           |
| 4. BK                                     | 9. OG                                       |   |   |  |       |       |       |        |       |        |       |        |       |           |       |           |       |           |       |           |
| 5. WH                                     | 10. BN                                      |   |   |  |       |       |       |        |       |        |       |        |       |           |       |           |       |           |       |           |
| <b>CKNM 12-9-*</b><br><b>CKNWM 12-9-*</b> | <b>CSNM 12-9-*</b><br><b>CSNWM 12-9-*</b>   | ITC/PLTC PVC Blue, 9x22 AWG, 105 °C, 300 V, 3 A, 6.9 mm OD, Cable #RF50741-*M, 4 port, Namur, 1 isolated circuit per port or 2 circuits per port with common positive, Flexlife | <table border="0"> <tr> <td>1. BN</td> <td>6. OG</td> </tr> <tr> <td>2. WH</td> <td>7. BU</td> </tr> <tr> <td>3. BK</td> <td>8. YE</td> </tr> <tr> <td>4. GN</td> <td>9. VT</td> </tr> <tr> <td>5. RD</td> <td></td> </tr> </table> | 1. BN  | 6. OG | 2. WH | 7. BU | 3. BK  | 8. YE | 4. GN  | 9. VT | 5. RD  |       |           |       |           |       |           |       |           |
| 1. BN                                     | 6. OG                                       |   |   |  |       |       |       |        |       |        |       |        |       |           |       |           |       |           |       |           |
| 2. WH                                     | 7. BU                                       |   |   |  |       |       |       |        |       |        |       |        |       |           |       |           |       |           |       |           |
| 3. BK                                     | 8. YE                                       |   |   |  |       |       |       |        |       |        |       |        |       |           |       |           |       |           |       |           |
| 4. GN                                     | 9. VT                                       |   |   |  |       |       |       |        |       |        |       |        |       |           |       |           |       |           |       |           |
| 5. RD                                     |   |   |   |  |       |       |       |        |       |        |       |        |       |           |       |           |       |           |       |           |
| <p><b>CS*M..</b></p>                      | <b>CKNM 16-16-*</b><br><b>CKNWM 16-16-*</b> | <b>CSNM 16-16-*</b><br><b>CSNWM 16-16-*</b>   | ITC/PLTC PVC Blue, 16x22 AWG, 105 °C, 300 V, 3 A, 8.3 mm OD, Cable #RF50744-*M, 4 port, 2 isolated circuits per port, Flexlife  | <table border="0"> <tr> <td>1. WH</td> <td>9. VT</td> </tr> <tr> <td>2. BK</td> <td>10. GY</td> </tr> <tr> <td>3. GN</td> <td>11. PK</td> </tr> <tr> <td>4. RD</td> <td>12. TN</td> </tr> <tr> <td>5. OG</td> <td>13. WH/BK</td> </tr> <tr> <td>6. BU</td> <td>14. WH/GN</td> </tr> <tr> <td>7. BN</td> <td>15. WH/RD</td> </tr> <tr> <td>8. YE</td> <td>16. WH/BU</td> </tr> </table> | 1. WH | 9. VT | 2. BK | 10. GY | 3. GN | 11. PK | 4. RD | 12. TN | 5. OG | 13. WH/BK | 6. BU | 14. WH/GN | 7. BN | 15. WH/RD | 8. YE | 16. WH/BU |
|   | 1. WH                                       | 9. VT   |   |  |       |       |       |        |       |        |       |        |       |           |       |           |       |           |       |           |
| 2. BK                                     | 10. GY                                      |   |   |  |       |       |       |        |       |        |       |        |       |           |       |           |       |           |       |           |
| 3. GN                                     | 11. PK                                      |   |   |  |       |       |       |        |       |        |       |        |       |           |       |           |       |           |       |           |
| 4. RD                                     | 12. TN                                      |   |   |  |       |       |       |        |       |        |       |        |       |           |       |           |       |           |       |           |
| 5. OG                                     | 13. WH/BK                                   |   |   |  |       |       |       |        |       |        |       |        |       |           |       |           |       |           |       |           |
| 6. BU                                     | 14. WH/GN                                   |   |   |  |       |       |       |        |       |        |       |        |       |           |       |           |       |           |       |           |
| 7. BN                                     | 15. WH/RD                                   |   |   |  |       |       |       |        |       |        |       |        |       |           |       |           |       |           |       |           |
| 8. YE                                     | 16. WH/BU                                   |   |   |  |       |       |       |        |       |        |       |        |       |           |       |           |       |           |       |           |
| <p><b>CS*WM..</b></p>                     |   |   |   |  |       |       |       |        |       |        |       |        |       |           |       |           |       |           |       |           |

We reserve the right to make technical alterations without prior notice.

\* Length in meters.  
 Standard cable lengths are 5 and 10 meters. Consult factory for other lengths.  
 Standard coupling nut material is nickel plated brass.. "CKR(N)M.."; "CKR(N)MV.." indicates stainless steel coupling nut.

## 12 and 16-Pin Connectors, NAMUR Color Code

- For Eurofast® Junction Boxes and Multi-Conductor Applications
- IEC IP67 Protection



| Connector Style   | Male Part Number                                      | Features  | Pinout   |
|---|---|---|--|
| <p><b>CSSNM ..</b></p> <p><b>Non-rotating coupling nut</b></p>  | <p><b>CSSNM 12-9-*</b><br/><b>CSSNWM 12-9-*</b></p>   | <p>ITC/PLTC PVC Blue, 9x22 AWG, 105 °C, 300 V, 3 A, 6.9 mm OD, Cable #RF50741-*M, 4 port, Namur, 1 isolated circuit per port or 2 circuits per port with common positive, Flexlife®</p> | <p>1. BN<br/>2. WH<br/>3. BK<br/>4. GN<br/>5. RD<br/>6. OG<br/>7. BU<br/>8. YE<br/>9. VT</p> <p><b>Male</b></p>  |
| <p><b>CSSNWM ..</b></p> <p><b>Non-rotating coupling nut</b></p> | <p><b>CSSNM 16-16-*</b><br/><b>CSSNWM 16-16-*</b></p> | <p>ITC/PLTC PVC Blue, 16x22 AWG, 105 °C, 300 V, 3 A, 8.3 mm OD, Cable #RF50744-*M, 4 port, 2 isolated circuits per port, Flexlife</p>   | <p>1. WH<br/>2. BK<br/>3. GN<br/>4. RD<br/>5. OG<br/>6. BU<br/>7. BN<br/>8. YE<br/>9. VT<br/>10. GY<br/>11. PK<br/>12. TN<br/>13. WH/BK<br/>14. WH/GN<br/>15. WH/RD<br/>16. WH/BU</p> <p><b>Male</b></p> |

We reserve the right to make technical alterations without prior notice.

Cordsets

\* Length in meters.  
Standard cable lengths are 5 and 10 meters. Consult factory for other lengths.  
Standard coupling nut material is nickel plated brass.. "CSSNM..".

- Quick Push-Pull Connector
- For Eurofast® Junction Boxes and Multi-Conductor Applications
- IEC IP67 Protection



| Connector Style | Female Part Number      | Features  | Pinout   |
|-----------------|-------------------------|---|--|
|                 | <b>CKMH 12-11-*</b>     | ITC/PLTC PVC Yellow, 11x18 AWG, 105 °C, 300 V, 6 A, 10.5 mm OD, Cable #RF51088-*M, 8 port, 1 signal per port, Flexlife® | 1. BN<br>2. N/C<br>3. BU<br>4. WH<br>5. GN<br>6. YE<br>7. GY<br>8. PK<br>9. RD<br>10. BK<br>11. VT<br>12. GN/YE  |
|                 | <b>CKMH 12-11-*/S90</b> | AWM TPU Yellow, 11x18 AWG, 90 °C, 10 mm OD, Cable #RF50678-*M, 8 port, 1 signal per port, Cut/Abrasion Immune           |  |
|                 | <b>CKMH 19-19-*</b>     | ITC/PLTC PVC Yellow, 3x18, 16x22 AWG, 105 °C, 10.0 mm OD, Cable #RF50620-*M, 8 port, 2 signals per port, Flexlife       | 1. VT<br>2. RD<br>3. GY<br>4. RD/BU<br>5. GN<br>6. BU<br>7. GY/PK<br>8. WH/GN<br>9. WH/YE<br>10. WH/GY<br>11. BK<br>12. GN/YE<br>13. YE/BN<br>14. BN/GN<br>15. WH<br>16. YE<br>17. PK<br>18. GY/BN<br>19. BN |
|                 | <b>CKMH 19-19-*/S90</b> | AWM TPU Yellow, 3x18, 16x22 AWG, 90 °C, 10.0 mm OD, Cable #RF50682-*M, 8 port, 2 signals per port Cut/Abrasion Immune   |  |

We reserve the right to make technical alterations without prior notice.

\* Length in meters.  
 Standard cable lengths are 5 and 10 meters. Consult factory for other lengths.  
 Standard coupling nut material is nickel plated brass..“CKMH..”.



26 and 28-Pin Cordsets

- For Multi-Conductor Applications
- IEC IP67 Protection
- 150 V, 3 A



| Connector Style                            | Female Part Number                                  | Male Part Number                                    | Features  | Pinout                                  |
|--|---|---|---|---|
| <p><b>DKM ..</b></p> <p><b>DKWM ..</b></p> | <p><b>DKM 26-631-*</b><br/><b>DKWM 26-631-*</b></p> | <p><b>DSM 26-631-*</b><br/><b>DSWM 26-631-*</b></p> | <p>ITC/PLTC PVC Yellow, 25x22 AWG, 1x22 AWG drain, 105 °C, 10.0 mm OD, Cable #RF50631-<sup>*</sup>M, 25-wire DC applications, Flexlife®</p> | <p><b>Female</b></p> <p><b>Male</b></p> |
| <p><b>DSM ..</b></p> <p><b>DSWM ..</b></p> | <p><b>DKM 28-061-*</b><br/><b>DKWM 28-061-*</b></p> | <p><b>DSM 28-061-*</b><br/><b>DSWM 28-061-*</b></p> | <p>ITC/PLTC PVC Yellow, 27x22 AWG, 1x22 AWG drain, 105 °C, 10.5 mm OD, Cable #RF51061-<sup>*</sup>M, 27-wire DC applications, Flexlife</p>  | <p><b>Female</b></p> <p><b>Male</b></p> |

We reserve the right to make technical alterations without prior notice.

Cordsets

\* Length in meters. Standard cable lengths are 5 and 10 meters. Consult factory for other lengths. Standard coupling nut material is nickel plated brass.. "DKM.." / "DKWM..".

## 26 and 28-Pin Cordsets

- For Multi-Conductor Applications
- IEC IP67 Protection
- 150 V, 5 A





| Connector Style   | Male Part Number                                      | Features   | Pinout   |       |        |          |           |          |           |          |           |          |           |          |           |          |           |          |           |          |           |           |           |           |           |           |           |        |         |        |         |
|---|---|--|--|-------|--------|----------|-----------|----------|-----------|----------|-----------|----------|-----------|----------|-----------|----------|-----------|----------|-----------|----------|-----------|-----------|-----------|-----------|-----------|-----------|-----------|--------|---------|--------|---------|
| <p><b>DSSM ..</b></p> <p>Non-rotating coupling nut</p>  | <p><b>DSSM 26-631-*</b><br/><b>DSSWM 26-631-*</b></p> | <p>ITC/PLTC PVC Yellow, 25x22 AWG, 1x22 AWG drain, 105 °C, 10.0 mm OD, Cable #RF50631-*M, 25-wire DC applications, Flexlife®</p> | <table border="0"> <tr><td>1. BN</td><td>14. WH</td></tr> <tr><td>2. WH/GY</td><td>15. BU</td></tr> <tr><td>3. BU/GY</td><td>16. BK/GY</td></tr> <tr><td>4. BN/GY</td><td>17. BN/OG</td></tr> <tr><td>5. BK/YE</td><td>18. WH/OG</td></tr> <tr><td>6. WH/YE</td><td>19. BK/OG</td></tr> <tr><td>7. BU/YE</td><td>20. BK/GN</td></tr> <tr><td>8. BN/YE</td><td>21. WH/GN</td></tr> <tr><td>9. BK/RD</td><td>22. BU/GN</td></tr> <tr><td>10. WH/RD</td><td>23. BN/GN</td></tr> <tr><td>11. BU/RD</td><td>24. BU/OG</td></tr> <tr><td>12. BN/RD</td><td>25. GN/YE</td></tr> <tr><td>13. BK</td><td>26. N/C</td></tr> </table> <p>Male</p>   | 1. BN | 14. WH | 2. WH/GY | 15. BU    | 3. BU/GY | 16. BK/GY | 4. BN/GY | 17. BN/OG | 5. BK/YE | 18. WH/OG | 6. WH/YE | 19. BK/OG | 7. BU/YE | 20. BK/GN | 8. BN/YE | 21. WH/GN | 9. BK/RD | 22. BU/GN | 10. WH/RD | 23. BN/GN | 11. BU/RD | 24. BU/OG | 12. BN/RD | 25. GN/YE | 13. BK | 26. N/C |        |         |
| 1. BN   | 14. WH  |  |  |       |        |          |           |          |           |          |           |          |           |          |           |          |           |          |           |          |           |           |           |           |           |           |           |        |         |        |         |
| 2. WH/GY  | 15. BU  |  |  |       |        |          |           |          |           |          |           |          |           |          |           |          |           |          |           |          |           |           |           |           |           |           |           |        |         |        |         |
| 3. BU/GY  | 16. BK/GY   |  |  |       |        |          |           |          |           |          |           |          |           |          |           |          |           |          |           |          |           |           |           |           |           |           |           |        |         |        |         |
| 4. BN/GY  | 17. BN/OG   |  |  |       |        |          |           |          |           |          |           |          |           |          |           |          |           |          |           |          |           |           |           |           |           |           |           |        |         |        |         |
| 5. BK/YE  | 18. WH/OG   |  |  |       |        |          |           |          |           |          |           |          |           |          |           |          |           |          |           |          |           |           |           |           |           |           |           |        |         |        |         |
| 6. WH/YE  | 19. BK/OG   |  |  |       |        |          |           |          |           |          |           |          |           |          |           |          |           |          |           |          |           |           |           |           |           |           |           |        |         |        |         |
| 7. BU/YE  | 20. BK/GN   |  |  |       |        |          |           |          |           |          |           |          |           |          |           |          |           |          |           |          |           |           |           |           |           |           |           |        |         |        |         |
| 8. BN/YE  | 21. WH/GN   |  |  |       |        |          |           |          |           |          |           |          |           |          |           |          |           |          |           |          |           |           |           |           |           |           |           |        |         |        |         |
| 9. BK/RD  | 22. BU/GN   |  |  |       |        |          |           |          |           |          |           |          |           |          |           |          |           |          |           |          |           |           |           |           |           |           |           |        |         |        |         |
| 10. WH/RD   | 23. BN/GN   |  |  |       |        |          |           |          |           |          |           |          |           |          |           |          |           |          |           |          |           |           |           |           |           |           |           |        |         |        |         |
| 11. BU/RD   | 24. BU/OG   |  |  |       |        |          |           |          |           |          |           |          |           |          |           |          |           |          |           |          |           |           |           |           |           |           |           |        |         |        |         |
| 12. BN/RD   | 25. GN/YE   |  |  |       |        |          |           |          |           |          |           |          |           |          |           |          |           |          |           |          |           |           |           |           |           |           |           |        |         |        |         |
| 13. BK  | 26. N/C   |  |  |       |        |          |           |          |           |          |           |          |           |          |           |          |           |          |           |          |           |           |           |           |           |           |           |        |         |        |         |
| <p><b>DSSWM ..</b></p> <p>Non-rotating coupling nut</p> | <p><b>DSSM 28-061-*</b><br/><b>DSSWM 28-061-*</b></p> | <p>ITC/PLTC PVC Yellow, 27x22 AWG, 1x22 AWG drain, 105 °C, 10.5 mm OD, Cable #RF51061-*M, 27-wire DC applications, Flexlife</p>  | <table border="0"> <tr><td>1. BN</td><td>15. BU</td></tr> <tr><td>2. WH/GY</td><td>16. BK/GY</td></tr> <tr><td>3. BU/GY</td><td>17. BN/OG</td></tr> <tr><td>4. BN/GY</td><td>18. WH/OG</td></tr> <tr><td>5. BK/YE</td><td>19. BK/OG</td></tr> <tr><td>6. WH/YE</td><td>20. BK/GN</td></tr> <tr><td>7. BU/YE</td><td>21. WH/GN</td></tr> <tr><td>8. BN/YE</td><td>22. BU/GN</td></tr> <tr><td>9. BK/RD</td><td>23. BN/GN</td></tr> <tr><td>10. WH/RD</td><td>24. BU/OG</td></tr> <tr><td>11. BU/RD</td><td>25. GN/YE</td></tr> <tr><td>12. BN/RD</td><td>26. GY</td></tr> <tr><td>13. BK</td><td>27. OG</td></tr> <tr><td>14. WH</td><td>28. N/C</td></tr> </table> <p>Male</p> | 1. BN | 15. BU | 2. WH/GY | 16. BK/GY | 3. BU/GY | 17. BN/OG | 4. BN/GY | 18. WH/OG | 5. BK/YE | 19. BK/OG | 6. WH/YE | 20. BK/GN | 7. BU/YE | 21. WH/GN | 8. BN/YE | 22. BU/GN | 9. BK/RD | 23. BN/GN | 10. WH/RD | 24. BU/OG | 11. BU/RD | 25. GN/YE | 12. BN/RD | 26. GY    | 13. BK | 27. OG  | 14. WH | 28. N/C |
| 1. BN   | 15. BU  |  |  |       |        |          |           |          |           |          |           |          |           |          |           |          |           |          |           |          |           |           |           |           |           |           |           |        |         |        |         |
| 2. WH/GY  | 16. BK/GY   |  |  |       |        |          |           |          |           |          |           |          |           |          |           |          |           |          |           |          |           |           |           |           |           |           |           |        |         |        |         |
| 3. BU/GY  | 17. BN/OG   |  |  |       |        |          |           |          |           |          |           |          |           |          |           |          |           |          |           |          |           |           |           |           |           |           |           |        |         |        |         |
| 4. BN/GY  | 18. WH/OG   |  |  |       |        |          |           |          |           |          |           |          |           |          |           |          |           |          |           |          |           |           |           |           |           |           |           |        |         |        |         |
| 5. BK/YE  | 19. BK/OG   |  |  |       |        |          |           |          |           |          |           |          |           |          |           |          |           |          |           |          |           |           |           |           |           |           |           |        |         |        |         |
| 6. WH/YE  | 20. BK/GN   |  |  |       |        |          |           |          |           |          |           |          |           |          |           |          |           |          |           |          |           |           |           |           |           |           |           |        |         |        |         |
| 7. BU/YE  | 21. WH/GN   |  |  |       |        |          |           |          |           |          |           |          |           |          |           |          |           |          |           |          |           |           |           |           |           |           |           |        |         |        |         |
| 8. BN/YE  | 22. BU/GN   |  |  |       |        |          |           |          |           |          |           |          |           |          |           |          |           |          |           |          |           |           |           |           |           |           |           |        |         |        |         |
| 9. BK/RD  | 23. BN/GN   |  |  |       |        |          |           |          |           |          |           |          |           |          |           |          |           |          |           |          |           |           |           |           |           |           |           |        |         |        |         |
| 10. WH/RD   | 24. BU/OG   |  |  |       |        |          |           |          |           |          |           |          |           |          |           |          |           |          |           |          |           |           |           |           |           |           |           |        |         |        |         |
| 11. BU/RD   | 25. GN/YE   |  |  |       |        |          |           |          |           |          |           |          |           |          |           |          |           |          |           |          |           |           |           |           |           |           |           |        |         |        |         |
| 12. BN/RD   | 26. GY  |  |  |       |        |          |           |          |           |          |           |          |           |          |           |          |           |          |           |          |           |           |           |           |           |           |           |        |         |        |         |
| 13. BK  | 27. OG  |  |  |       |        |          |           |          |           |          |           |          |           |          |           |          |           |          |           |          |           |           |           |           |           |           |           |        |         |        |         |
| 14. WH  | 28. N/C   |  |  |       |        |          |           |          |           |          |           |          |           |          |           |          |           |          |           |          |           |           |           |           |           |           |           |        |         |        |         |

We reserve the right to make technical alterations without prior notice.

\* Length in meters.  
Standard cable lengths are 5 and 10 meters. Consult factory for other lengths.  
Standard coupling material is nickel plated brass. "DSSM.." / "DSSWM..".

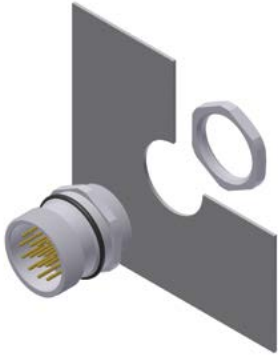
**Receptacle Selection Guide**

| Mounting Style            | Image  | Panel Thread Types  | Page |
|---------------------------|--|---|------|
| <p><b>Front Mount</b></p> |   | <p><u>M23</u> <span style="float: right;"><u>H20</u></span></p> <hr/> <p><u>M27</u> <span style="float: right;"><u>H30</u></span></p> |      |
| <p><b>Rear Mount</b></p>  |  | <p><u>M23</u> <span style="float: right;"><u>H25</u></span></p>   |      |

We reserve the right to make technical alterations without prior notice.

**Cordsets**

## 12-Pin Receptacles, Front Mount

- For use with Junction Box Home Run Cables
- IEC IP67 Protection
- 300 V, 6 A



| Connector Style   | Female Part Number      | Male Part Number        | Features  | Pinout  |  |
|---|-------------------------|-------------------------|---|---|--|
| <p><b>CS(K)F..</b></p> <p>Typical panel cutout is 20.4 x 19 x 20.4 mm</p> | <b>CKF 12-7-*</b>       | <b>CSF 12-7-*</b>       | Nickel plated brass, 7x18 AWG, 105 °C, 4-port, 1 signal per port  | 1. BN<br>3. BU<br>4. WH<br>6. GN                      | 7. YE<br>8. GY<br>12. GN/YE                                    |
|   | <b>CKF 12-9-*</b>       | <b>CKF 12-9-*</b>       | Nickel plated brass, 9x18 AWG, 105 °C, 6-port, 1 signal per port  | 1. BN<br>3. BU<br>4. WH<br>6. GN<br>7. YE             | 8. GY<br>9. PK<br>10. RD<br>12. GN/YE                          |
|   | <b>CKF 12-11-*</b>      | <b>CSF 12-11-*</b>      | Nickel plated brass, 11x18 AWG, 105 °C, 8-port, 1 signal per port | 1. BN<br>3. BU<br>4. WH<br>5. GN<br>6. YE<br>7. GY    | 8. PK<br>9. RD<br>10. BK<br>11. VT<br>12. GN/YE                |
|   | <b>CKF 12-12-*</b>      | <b>CSF 12-12-*</b>      | Nickel plated brass, 12x18 AWG, 105 °C, 8-port, 1 signal per port | 1. BN<br>2. OG<br>3. BU<br>4. WH<br>5. GN<br>6. YE    | 7. GY<br>8. PK<br>9. RD<br>10. BK<br>11. VT<br>12. GN/YE       |
|   | <b>CKF 12-12-*/S817</b> | <b>CSF 12-12-*/S817</b> | Nickel plated brass, 12x18 AWG, 105 °C, 8-port, 1 signal per port | 1. BN<br>2. BU<br>3. WH<br>4. GN/YE<br>5. OG<br>6. YE | 7. GY<br>8. PK<br>9. RD<br>10. BN/WH<br>11. BU/WH<br>12. GN/WH |

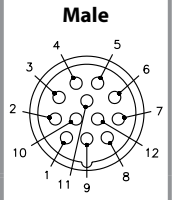
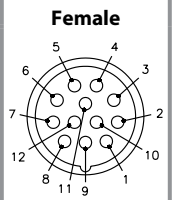

We reserve the right to make technical alterations without prior notice.

\* Length in meters. Standard lead length is 1 meter. Consult factory for other lengths.  
 "CSFL .." indicates long mounting threads; "CSFLV .." indicates stainless steel housing with long threads.  
 To specify PVC jacketed cable, add "/S717" to the end of the part number.

19-Pin Receptacles, Front Mount

- For use with Junction Box Home Run Cables
- IEC IP67 Protection
- 150 V, 9 A (pins 6, 12, 19), all others 2 A



We reserve the right to make technical alterations without prior notice.

| Connector Style   | Female Part Number | Male Part Number | Features   | Pinout  |
|---|--------------------|------------------|--|---|
| <p><b>CS(K)F..</b></p> <p>Typical panel cutout is 20.4 x 19 x 20.4 mm</p> | CKF 19-11-*        | CSF 19-11-*      | Nickel plated brass, 3x18, 8x22 AWG, 105 °C, 4-port, 2 signals per port  | 3. GY<br>4. RD/BU<br>5. GN<br>6. BU<br>7. GY/PK<br>8. WH/GN<br>12. GN/YE<br>14. BN/GN<br>15. WH<br>16. YE<br>19. BN   |
|   | CKF 19-15-*        | CSF 19-15-*      | Nickel plated brass, 3x18, 12x22 AWG, 105 °C, 6-port, 2 signals per port | <p><b>Female</b></p> 2. RD<br>3. GY<br>4. RD/BU<br>5. GN<br>6. BU<br>7. GY/PK<br>8. WH/GN<br>9. WH/YE<br>12. GN/YE<br>14. BN/GN<br>15. WH<br>16. YE<br>17. PK<br>19. BN   |
|   | CKF 19-19-*        | CSF 19-19-*      | Nickel plated brass, 3x18, 16x22 AWG, 105 °C, 8-port, 2 signals per port | <p><b>Male</b></p> 1. VT<br>2. RD<br>3. GY<br>4. RD/BU<br>5. GN<br>6. BU<br>7. GY/PK<br>8. WH/GN<br>9. WH/YE<br>10. WH/GY<br>11. BK<br>12. GN/YE<br>13. YE/BN<br>14. BN/GN<br>15. WH<br>16. YE<br>17. PK<br>18. GY/BN<br>19. BN |

Receptacles

\* Length in meters. Standard lead length is 1 meter. Consult factory for other lengths.  
 "CSFL..." indicates long mounting threads; "CSFLV..." indicates stainless steel housing with long threads.  
 To specify PVC jacketed cable, add "/S717" to the end of the part number.

12 and 16-Pin Receptacles, Front Mount

- For use with Junction Box Home Run Cables
- IEC IP67 Protection



| Connector Style  | Female Part Number  | Male Part Number  | Features   | Pinout   |          |       |       |          |        |           |           |           |           |           |           |        |       |           |
|--|---------------------|---|--|--|----------|-------|-------|----------|--------|-----------|-----------|-----------|-----------|-----------|-----------|--------|-------|-----------|
| <p><b>CK(A)(B)F..<br/>CS(A)(B)F..</b></p> <p>Typical panel cutout is 20.4 x 19 x 20.4 mm</p>   | <b>CKAF 16-10-*</b> | <b>CSAF 16-10-*</b>   | Nickel plated brass, 10x18 AWG, 105 °C, 150 V, 6 A, 4-port, Isolated Power Supply  | <table border="0"> <tr><td>1. BN</td><td>7. YE</td></tr> <tr><td>3. BU</td><td>8. GY</td></tr> <tr><td>4. WH</td><td>11. BN/WH</td></tr> <tr><td>5. GN/YE</td><td>13. BU/WH</td></tr> <tr><td>6. OG</td><td>15. GN/WH</td></tr> </table> <p><b>Female</b></p>  | 1. BN    | 7. YE | 3. BU | 8. GY    | 4. WH  | 11. BN/WH | 5. GN/YE  | 13. BU/WH | 6. OG     | 15. GN/WH |           |        |       |           |
|  | 1. BN               | 7. YE   |  |  |          |       |       |          |        |           |           |           |           |           |           |        |       |           |
| 3. BU  | 8. GY               |   |  |  |          |       |       |          |        |           |           |           |           |           |           |        |       |           |
| 4. WH  | 11. BN/WH           |   |  |  |          |       |       |          |        |           |           |           |           |           |           |        |       |           |
| 5. GN/YE   | 13. BU/WH           |   |  |  |          |       |       |          |        |           |           |           |           |           |           |        |       |           |
| 6. OG  | 15. GN/WH           |   |  |  |          |       |       |          |        |           |           |           |           |           |           |        |       |           |
| <b>CKAF 16-12-*</b>  | <b>CSAF 16-12-*</b> | Nickel plated brass, 12x18 AWG, 105 °C, 150 V, 6 A, 6-port, Isolated Power Supply | <table border="0"> <tr><td>1. BN</td><td>8. GY</td></tr> <tr><td>3. BU</td><td>9. PK</td></tr> <tr><td>4. WH</td><td>10. RD</td></tr> <tr><td>5. GN/YE</td><td>11. BN/WH</td></tr> <tr><td>6. OG</td><td>13. BU/WH</td></tr> <tr><td>7. YE</td><td>15. GN/WH</td></tr> </table> <p><b>Female</b></p> | 1. BN  | 8. GY    | 3. BU | 9. PK | 4. WH    | 10. RD | 5. GN/YE  | 11. BN/WH | 6. OG     | 13. BU/WH | 7. YE     | 15. GN/WH |        |       |           |
| 1. BN  | 8. GY               |   |  |  |          |       |       |          |        |           |           |           |           |           |           |        |       |           |
| 3. BU  | 9. PK               |   |  |  |          |       |       |          |        |           |           |           |           |           |           |        |       |           |
| 4. WH  | 10. RD              |   |  |  |          |       |       |          |        |           |           |           |           |           |           |        |       |           |
| 5. GN/YE   | 11. BN/WH           |   |  |  |          |       |       |          |        |           |           |           |           |           |           |        |       |           |
| 6. OG  | 13. BU/WH           |   |  |  |          |       |       |          |        |           |           |           |           |           |           |        |       |           |
| 7. YE  | 15. GN/WH           |   |  |  |          |       |       |          |        |           |           |           |           |           |           |        |       |           |
| <p><b>CK(A)(B)FL..<br/>CS(A)(B)FL..</b></p> <p>Typical panel cutout is 20.4 x 19 x 20.4 mm</p> | <b>CKAF 16-14-*</b> | <b>CSAF 16-14-*</b>   | Nickel plated brass, 14x18 AWG, 105 °C, 150 V, 6 A, 8-port, Isolated Power Supply  | <table border="0"> <tr><td>1. BN</td><td>9. PK</td></tr> <tr><td>3. BU</td><td>10. RD</td></tr> <tr><td>4. WH</td><td>11. BN/WH</td></tr> <tr><td>5. GN/YE</td><td>12. BK</td></tr> <tr><td>6. OG</td><td>13. BU/WH</td></tr> <tr><td>7. YE</td><td>14. VT</td></tr> <tr><td>8. GY</td><td>15. GN/WH</td></tr> </table> <p><b>Female</b></p> | 1. BN    | 9. PK | 3. BU | 10. RD   | 4. WH  | 11. BN/WH | 5. GN/YE  | 12. BK    | 6. OG     | 13. BU/WH | 7. YE     | 14. VT | 8. GY | 15. GN/WH |
|  | 1. BN               | 9. PK   |  |  |          |       |       |          |        |           |           |           |           |           |           |        |       |           |
| 3. BU  | 10. RD              |   |  |  |          |       |       |          |        |           |           |           |           |           |           |        |       |           |
| 4. WH  | 11. BN/WH           |   |  |  |          |       |       |          |        |           |           |           |           |           |           |        |       |           |
| 5. GN/YE   | 12. BK              |   |  |  |          |       |       |          |        |           |           |           |           |           |           |        |       |           |
| 6. OG  | 13. BU/WH           |   |  |  |          |       |       |          |        |           |           |           |           |           |           |        |       |           |
| 7. YE  | 14. VT              |   |  |  |          |       |       |          |        |           |           |           |           |           |           |        |       |           |
| 8. GY  | 15. GN/WH           |   |  |  |          |       |       |          |        |           |           |           |           |           |           |        |       |           |
| <b>CKBF 12-7-*</b>   | <b>CSBF 12-7-*</b>  | Nickel plated brass, 7x18 AWG, 105 °C, 300 V, 6 A, 4-port, with LEDs              | <table border="0"> <tr><td>1. WH/BK</td><td>5. OG</td></tr> <tr><td>2. BK</td><td>6. BU</td></tr> <tr><td>3. WH</td><td>7. GN</td></tr> <tr><td>4. RD</td><td></td></tr> </table> <p><b>Female</b></p>   | 1. WH/BK   | 5. OG    | 2. BK | 6. BU | 3. WH    | 7. GN  | 4. RD     |           |           |           |           |           |        |       |           |
| 1. WH/BK   | 5. OG               |   |  |  |          |       |       |          |        |           |           |           |           |           |           |        |       |           |
| 2. BK  | 6. BU               |   |  |  |          |       |       |          |        |           |           |           |           |           |           |        |       |           |
| 3. WH  | 7. GN               |   |  |  |          |       |       |          |        |           |           |           |           |           |           |        |       |           |
| 4. RD  |                     |   |  |  |          |       |       |          |        |           |           |           |           |           |           |        |       |           |
| <b>CKBF 12-11-*</b>  | <b>CSBF 12-11-*</b> | Nickel plated brass, 11x18 AWG, 105 °C, 300 V, 6 A, 8-port, with LEDs             | <table border="0"> <tr><td>1. OG</td><td>7. BU/BK</td></tr> <tr><td>2. BU</td><td>9. GN</td></tr> <tr><td>3. WH/BK</td><td>10. RD</td></tr> <tr><td>4. RD/BK</td><td>11. WH</td></tr> <tr><td>5. GN/BK</td><td>12. BK</td></tr> <tr><td>6. OG/BK</td><td></td></tr> </table> <p><b>Female</b></p>    | 1. OG  | 7. BU/BK | 2. BU | 9. GN | 3. WH/BK | 10. RD | 4. RD/BK  | 11. WH    | 5. GN/BK  | 12. BK    | 6. OG/BK  |           |        |       |           |
| 1. OG  | 7. BU/BK            |   |  |  |          |       |       |          |        |           |           |           |           |           |           |        |       |           |
| 2. BU  | 9. GN               |   |  |  |          |       |       |          |        |           |           |           |           |           |           |        |       |           |
| 3. WH/BK   | 10. RD              |   |  |  |          |       |       |          |        |           |           |           |           |           |           |        |       |           |
| 4. RD/BK   | 11. WH              |   |  |  |          |       |       |          |        |           |           |           |           |           |           |        |       |           |
| 5. GN/BK   | 12. BK              |   |  |  |          |       |       |          |        |           |           |           |           |           |           |        |       |           |
| 6. OG/BK   |                     |   |  |  |          |       |       |          |        |           |           |           |           |           |           |        |       |           |

We reserve the right to make technical alterations without prior notice.

\* Length in meters. Standard lead length is 1 meter. Consult factory for other lengths.  
 "CSA(B)FL .." indicates long mounting threads; "CSA(B)FLV .." indicates stainless steel housing with long threads.  
 To specify PVC jacketed cable, add "/S717" to the end of the part number.

12-Pin Receptacles, Front Mount

- For use with Junction Box Home Run Cables
- IEC IP67 Protection
- 300 V, 6 A



| Connector Style   | Female Part Number  | Male Part Number    | Features   | Pinout  |
|---|---------------------|---------------------|--|---|
| <p><b>CK(C)(N)F..</b><br/><b>CS(C)(N)F..</b></p> <p>Typical panel cutout is 20.4 x 19 x 20.4 mm</p>   | <b>CKCF 12-7-*</b>  | <b>CSCF 12-7-*</b>  | Nickel plated brass, 7x18 AWG, 105 °C, 4-port, 1 signal per port, 4MB12Z-4-*   | <p>1. WH<br/>2. GN<br/>3. YE<br/>4. GY<br/>10. BU<br/>11. BN<br/>12. GN/YE</p> <p><b>Female</b></p>   |
| <p><b>CK(C)(N)FL..</b><br/><b>CS(C)(N)FL..</b></p> <p>Typical panel cutout is 20.4 x 19 x 20.4 mm</p> | <b>CKCF 12-11-*</b> | <b>CSCF 12-11-*</b> | Nickel plated brass, 11x18 AWG, 105 °C, 8-port, 1 signal per port, 8MB12Z-4-*  | <p>1. WH<br/>2. GN<br/>3. YE<br/>4. GY<br/>5. PK<br/>6. RD<br/>7. BK<br/>8. VT<br/>10. BU<br/>11. BN<br/>12. GN/YE</p> <p><b>Female</b></p> |
| <p><b>CK(C)(N)FL..</b><br/><b>CS(C)(N)FL..</b></p> <p>Typical panel cutout is 20.4 x 19 x 20.4 mm</p> | <b>CKNF 12-9-*</b>  | <b>CSNF 12-9-*</b>  | Nickel plated brass, 9x18 AWG, 105 °C, 4-port, 1 isolated circuit per port or 2 circuits per port with common positive | <p>1. BN<br/>2. WH<br/>3. BK<br/>4. GN<br/>5. RD<br/>6. OG<br/>7. BU<br/>8. YE<br/>9. VT</p> <p><b>Male</b></p>                             |

We reserve the right to make technical alterations without prior notice.

Receptacles

\* Length in meters. Standard lead length is 1 meter. Consult factory for other lengths.  
 "CSC(N or R)FL .." indicates long mounting threads; "CSC(N or R)FLV .." indicates stainless steel housing with long threads.  
 To specify PVC jacketed cable, add "/S717" to the end of the part number.

- For use with Junction Box Home Run Cables
- IEC IP67 Protection



| Connector Style   | Female Part Number  | Male Part Number    | Features   | Pinout                                  |
|---|---------------------|---------------------|--|---|
| <p><b>CK(C)(N)(R)F..</b><br/><b>CS(C)(N)(R)F..</b></p> <p>Typical panel cutout is 20.4 x 19 x 20.4 mm</p>   | <b>CKNF 16-16-*</b> | <b>CSNF 16-16-*</b> | Nickel plated brass, 16x22 AWG, 105 °C, 300 V, 3 A, 4-port, 2 isolated circuits per port | <p><b>Female</b></p> <p><b>Male</b></p> |
|   | <b>CKRF 12-6-*</b>  | <b>CSRF 12-6-*</b>  | Nickel plated brass, 6x18 AWG, 105 °C, 300 V, 6 A, 4-port, No LEDs                       | <p><b>Female</b></p>                    |
|   | <b>CKRF 12-8-*</b>  | <b>CSRF 12-8-*</b>  | Nickel plated brass, 8x18 AWG, 105 °C, 300 V, 6 A, 6-port, No LEDs                       |   |
| <p><b>CK(C)(N)(R)FL..</b><br/><b>CS(C)(N)(R)FL..</b></p> <p>Typical panel cutout is 20.4 x 19 x 20.4 mm</p> | <b>CKRF 12-10-*</b> | <b>CSRF 12-10-*</b> | Nickel plated brass, 10x18 AWG, 105 °C, 300 V, 6 A, 8-port, No LEDs                      | <p><b>Male</b></p>                      |

We reserve the right to make technical alterations without prior notice.

\* Length in meters. Standard lead length is 1 meter. Consult factory for other lengths.  
 "CSC(N or R)FL .." indicates long mounting threads; "CSC(N or R)FLV .." indicates stainless steel housing with long threads.  
 To specify PVC jacketed cable, add "/S717" to the end of the part number.



12-Pin Receptacles, Rear Mount

- For use with Junction Box Home Run Cables
- IEC IP67 Protection
- 300 V, 6 A



| Connector Style  | Female Part Number       | Male Part Number         | Features  | Pinout   |
|--|--------------------------|--------------------------|---|--|
| <p><b>CS(K)FD..</b></p> <p>Typical panel cutout is 25.4 x 24.3 x 25.4 mm</p> | <b>CKFD 12-7-*</b>       | <b>CSFD 12-7-*</b>       | Nickel plated brass, 7x18 AWG, 105 °C, 4-port, 1 signal per port  | 1. BN<br>3. BU<br>4. WH<br>6. GN<br>7. YE<br>8. GY<br>12. GN/YE  |
|  | <b>CKFD 12-9-*</b>       | <b>CSFD 12-9-*</b>       | Nickel plated brass, 9x18 AWG, 105 °C, 6-port, 1 signal per port  | <b>Female</b><br><br>1. BN<br>3. BU<br>4. WH<br>6. GN<br>7. YE<br>8. GY<br>9. PK<br>10. RD<br>12. GN/YE                                    |
|  | <b>CKFD 12-11-*</b>      | <b>CSFD 12-11-*</b>      | Nickel plated brass, 11x18 AWG, 105 °C, 8-port, 1 signal per port | 1. BN<br>3. BU<br>4. WH<br>5. GN<br>6. YE<br>7. GY<br>8. PK<br>9. RD<br>10. BK<br>11. VT<br>12. GN/YE                                      |
|  | <b>CKFD 12-12-*</b>      | <b>CSFD 12-12-*</b>      | Nickel plated brass, 12x18 AWG, 105 °C, 8-port, 1 signal per port | 1. BN<br>2. OG<br>3. BU<br>4. WH<br>5. GN<br>6. YE<br>7. GY<br>8. PK<br>9. RD<br>10. BK<br>11. VT<br>12. GN/YE                             |
|  | <b>CKFD 12-12-*/S817</b> | <b>CSFD 12-12-*/S817</b> | Nickel plated brass, 12x18 AWG, 105 °C, 8-port, 1 signal per port | <b>Male</b><br><br>1. BN<br>2. BU<br>3. WH<br>4. GN/YE<br>5. OG<br>6. YE<br>7. GY<br>8. PK<br>9. RD<br>10. BN/WH<br>11. BU/WH<br>12. GN/WH |

We reserve the right to make technical alterations without prior notice.

Receptacles

\* Length in meters. Standard lead length is 1 meter. Consult factory for other lengths. To specify PVC jacketed cable, add "/S717" to the end of the part number.

## 19-Pin Receptacles, Rear Mount

- For use with Junction Box Home Run Cables
- IEC IP67 Protection
- 150 V, 9 A (pins 6, 12, 19), All others 2 A



| Connector Style   | Female Part Number | Male Part Number | Features   | Pinout   |
|---|--------------------|------------------|--|--|
| <p>CS(K)FD..</p> <p>Typical panel cutout is 25.4 x 24.3 x 25.4 mm</p> | CKFD 19-11-*       | CSFD 19-11-*     | Nickel plated brass, 3x18, 8x22 AWG, 105 °C, 4-port, 2 signals per port  | 3. GY<br>4. RD/BU<br>5. GN<br>6. BU<br>7. GY/PK<br>8. WH/GN<br>12. GN/YE<br>14. BN/GN<br>15. WH<br>16. YE<br>19. BN  |
|   | CKFD 19-15-*       | CSFD 19-15-*     | Nickel plated brass, 3x18, 12x22 AWG, 105 °C, 6-port, 2 signals per port | 2. RD<br>3. GY<br>4. RD/BU<br>5. GN<br>6. BU<br>7. GY/PK<br>8. WH/GN<br>9. WH/YE<br>12. GN/YE<br>13. YE/BN<br>14. BN/GN<br>15. WH<br>16. YE<br>17. PK<br>19. BN  |
|   | CKFD 19-19-*       | CSFD 19-19-*     | Nickel plated brass, 3x18, 16x22 AWG, 105 °C, 8-port, 2 signals per port | 1. VT<br>2. RD<br>3. GY<br>4. RD/BU<br>5. GN<br>6. BU<br>7. GY/PK<br>8. WH/GN<br>9. WH/YE<br>10. WH/GY<br>11. BK<br>12. GN/YE<br>13. YE/BN<br>14. BN/GN<br>15. WH<br>16. YE<br>17. PK<br>18. GY/BN<br>19. BN |

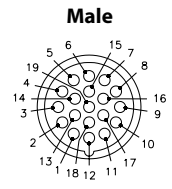
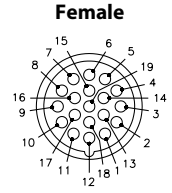

We reserve the right to make technical alterations without prior notice.

\* Length in meters. Standard lead length is 1 meter. Consult factory for other lengths. To specify PVC jacketed cable, add "/S717" to the end of the part number.

16-Pin Receptacles, Rear Mount

- For use with Junction Box Home Run Cables
- IEC IP67 Protection
- 150 V, 6 A



| Connector Style   | Female Part Number | Male Part Number | Features  | Pinout   |
|---|--------------------|------------------|---|--|
| <p>CS(K)FD..</p> <p>Typical panel cutout is 25.4 x 24.3 x 25.4 mm</p> | CKAFD 16-10-*      | CSAFD 16-10-*    | Nickel plated brass, 10x18 AWG, 105 °C, 4-port, Isolated Power Supply | <p>1. BN<br/>3. BU<br/>4. WH<br/>5. GN/YE<br/>6. OG<br/>7. YE<br/>8. GY<br/>11. BN/WH<br/>13. BU/WH<br/>15. GN/WH</p> <p>Female</p>  |
|   | CKAFD 16-12-*      | CSAFD 16-12-*    | Nickel plated brass 12x18 AWG, 105 °C, 6-port, Isolated Power Supply  | <p>1. BN<br/>3. BU<br/>4. WH<br/>5. GN/YE<br/>6. OG<br/>7. YE<br/>8. GY<br/>9. PK<br/>10. RD<br/>11. BN/WH<br/>13. BU/WH<br/>15. GN/WH</p>                                   |
|   | CKAFD 16-14-*      | CSAFD 16-14-*    | Nickel plated brass, 14x18 AWG, 105 °C, 8-port, Isolated Power Supply | <p>1. BN<br/>3. BU<br/>4. WH<br/>5. GN/YE<br/>6. OG<br/>7. YE<br/>8. GY<br/>9. PK<br/>10. RD<br/>11. BN/WH<br/>12. BK<br/>13. BU/WH<br/>14. VT<br/>15. GN/WH</p> <p>Male</p> |

We reserve the right to make technical alterations without prior notice.

Receptacles

\* Length in meters. Standard lead length is 1 meter. Consult factory for other lengths.  
To specify PVC jacketed cable, add "/S717" to the end of the part number.

## 12-Pin Receptacles, Rear Mount

- For use with Junction Box Home Run Cables
- IEC IP67 Protection
- 300 V, 6 A



| Connector Style  | Female Part Number   | Male Part Number     | Features  | Pinout   |
|--|----------------------|----------------------|---|--|
| <p><b>CS(K)FD..</b></p> <p>Typical panel cutout is 25.4 x 24.3 x 25.4 mm</p> | <b>CKBFD 12-7-*</b>  | <b>CSBFD 12-7-*</b>  | Nickel plated brass, 7x18 AWG, 105 °C, 4-port, with LEDs                      | <ol style="list-style-type: none"> <li>1. WH/BK</li> <li>2. BK</li> <li>3. WH</li> <li>4. RD</li> <li>5. OG</li> <li>6. BU</li> <li>7. GN</li> </ol>   |
|  | <b>CKBFD 12-11-*</b> | <b>CSBFD 12-11-*</b> | Nickel plated brass, 11x18 AWG, 105 °C, 8-port, with LEDs                     | <ol style="list-style-type: none"> <li>1. OG</li> <li>2. BU</li> <li>3. WH/BK</li> <li>4. RD/BK</li> <li>5. GN/BK</li> <li>6. OG/BK</li> <li>7. BU/BK</li> <li>9. GN</li> <li>10. RD</li> <li>11. WH</li> <li>12. BK</li> </ol> <p style="text-align: center;"><b>Female</b></p> |
|  | <b>CKCFD 12-7-*</b>  | <b>CSCFD 12-7-*</b>  | Nickel plated brass, 7x18 AWG, 105 °C, 4-port, 1 signal per port, 4MB12Z-4-*  | <ol style="list-style-type: none"> <li>1. WH</li> <li>2. GN</li> <li>3. YE</li> <li>4. GY</li> <li>10. BU</li> <li>11. BN</li> <li>12. GN/YE</li> </ol>  |
|  | <b>CKCFD 12-9-*</b>  | <b>CSCFD 12-9-*</b>  | Nickel plated brass, 9x18 AWG, 105 °C, 4-port, 1 signal per port, 6MB12Z-4-*  | <ol style="list-style-type: none"> <li>1. WH</li> <li>2. GN</li> <li>3. YE</li> <li>4. GY</li> <li>5. PK</li> <li>6. RD</li> <li>10. BU</li> <li>11. BN</li> <li>12. GN/YE</li> </ol> <p style="text-align: center;"><b>Male</b></p>   |
|  | <b>CKCFD 12-11-*</b> | <b>CSCFD 12-11-*</b> | Nickel plated brass, 11x18 AWG, 105 °C, 8-port, 1 signal per port, 8MB12Z-4-* | <ol style="list-style-type: none"> <li>1. WH</li> <li>2. GN</li> <li>3. YE</li> <li>4. GY</li> <li>5. PK</li> <li>6. RD</li> <li>7. BK</li> <li>8. VT</li> <li>10. BU</li> <li>11. BN</li> <li>12. GN/YE</li> </ol>  |

We reserve the right to make technical alterations without prior notice.

\* Length in meters. Standard lead length is 1 meter. Consult factory for other lengths. To specify PVC jacketed cable, add "/S717" to the end of the part number.

12 and 16-Pin Receptacles, Rear Mount

- For use with Junction Box Home Run Cables
- IEC IP67 Protection



We reserve the right to make technical alterations without prior notice.

Receptacles

| Connector Style  | Female Part Number   | Male Part Number     | Features   | Pinout  |
|--|----------------------|----------------------|--|---|
| <p><b>CS(K)FD..</b></p> <p>Typical panel cutout is 25.4 x 24.3 x 25.4 mm</p> | <b>CKNFD 12-9-*</b>  | <b>CSNFD 12-9-*</b>  | Nickel plated brass, 9x22 AWG, 105 °C, 300 V, 6 A, 4-port, 1 Isolated Circuits Per Port, 2 Circuits Per Port, with Common Positive | <p><b>Female</b></p> <p>1. BN<br/>2. WH<br/>3. BK<br/>4. GN<br/>5. RD<br/>6. OG<br/>7. BU<br/>8. YE<br/>9. VT</p> <p><b>Male</b></p>  |
|  | <b>CKNFD 16-16-*</b> | <b>CSNFD 16-16-*</b> | Nickel plated brass, 16x22 AWG, 105 °C, 300 V, 3 A, 4-port, 2 Isolated Circuits Per Port   | <p><b>Female</b></p> <p>1. WH<br/>2. BK<br/>3. GN<br/>4. RD<br/>5. OG<br/>6. BU<br/>7. BN<br/>8. YE<br/>9. VT<br/>10. GY<br/>11. PK<br/>12. Tn<br/>13. WH/BK<br/>14. WH/GN<br/>15. WH/RD<br/>16. WH/BU</p> <p><b>Male</b></p> |
|  | <b>CKRFD 12-6-*</b>  | <b>CSRFD 12-6-*</b>  | Nickel plated brass, 6x18 AWG, 105 °C, 300 V, 6 A, 4-port, No LEDs   | <p><b>Female</b></p>  |
|  | <b>CKRFD 12-8-*</b>  | <b>CSRFD 12-8-*</b>  | Nickel plated brass, 8x18 AWG, 105 °C, 300 V, 6 A, 6-port, No LEDs   | <p><b>Female</b></p> <p>1. OG 5. WH<br/>2. BU 6. RD<br/>3. YE 7. GN<br/>4. BK 8. BN</p>   |
|  | <b>CKRFD 12-10-*</b> | <b>CSRFD 12-10-*</b> | Nickel plated brass, 10x18 AWG, 105 °C, 300 V, 6 A, 8-port, No LEDs  | <p><b>Male</b></p> <p>1. VT<br/>2. BU<br/>3. GY<br/>4. BK<br/>5. WH<br/>6. RD<br/>7. GN<br/>8. YE<br/>9. OG<br/>10. BN</p>  |

## 26 and 28-Pin Receptacles, Front Mount

- For use with Junction Box Home Run Cables
- IEC IP67 Protection
- 150 V, 3 A



| Connector Style   | Female Part Number | Male Part Number | Features   | Pinout  |
|---|--------------------|------------------|--|---|
| <p><b>DS(K)F..</b></p> <p>Typical panel cutout is 28.3 mm</p> | DKF 26-25-*        | DSF 26-25-*      | Nickel-plated brass, 25x22 AWG, 105 °C, 25-wire applications | <p>1. BN<br/>2. WH/GY<br/>3. BU/GY<br/>4. BN/GY<br/>5. BK/YE<br/>6. WH/YE<br/>7. BU/YE<br/>8. BN/YE<br/>9. BK/RD<br/>10. WH/RD<br/>11. BU/RD<br/>12. BN/RD<br/>13. BK<br/>14. WH<br/>15. BU<br/>16. BK/GY<br/>17. BN/OG<br/>18. WH/OG<br/>19. BK/OG<br/>20. BK/GN<br/>21. WH/GN<br/>22. BU/GN<br/>23. BN/GN<br/>24. BU/OG<br/>25. GN/YE<br/>26. N/C</p> <p><b>Female</b></p> <p><b>Male</b></p>                       |
|   | DKF 28-27-*        | DSF 28-27-*      | Nickel-plated brass, 27x22 AWG, 105 °C, 27-wire applications | <p>1. BN<br/>2. WH/GY<br/>3. BU/GY<br/>4. BN/GY<br/>5. BK/YE<br/>6. WH/YE<br/>7. BU/YE<br/>8. BN/YE<br/>9. BK/RD<br/>10. WH/RD<br/>11. BU/RD<br/>12. BN/RD<br/>13. BK<br/>14. WH<br/>15. BU<br/>16. BK/GY<br/>17. BN/OG<br/>18. WH/OG<br/>19. BK/OG<br/>20. BK/GN<br/>21. WH/GN<br/>22. BU/GN<br/>23. BN/GN<br/>24. BU/OG<br/>25. GN/YE<br/>26. GY<br/>27. OG<br/>28. N/C</p> <p><b>Female</b></p> <p><b>Male</b></p> |

We reserve the right to make technical alterations without prior notice.

\* Length in meters. Standard lead length is 1 meter. Consult factory for other lengths. To specify PVC jacketed cable, add "/S717" to the end of the part number.

12, 16 and 19-Pin Field Wireable In-line Connectors

- For use with Custom Wiring & Junction Boxes
- Convert Hard Wiring into Quick Disconnect
- IEC IP65 Protection



| Connector Style | Female Part Number | Features  | Pinout               |
|-----------------|--------------------|---|----------------------|
|                 | CK 12-0            | Nickel plated brass, PG 11 cable gland, accepts 4-10 mm cable diameter, accepts up to 12x18 AWG conductors, 125 °C, 300 V, 8.0 A, field wireable 12-pin in-line connector, for use with Minifast®, Eurofast® (single input per port) and Microfast® junctions boxes | <p><b>Female</b></p> |
|                 | CK 16-0            | Nickel plated brass, PG 13.5 cable gland, accepts 5-12 mm cable diameter, accepts up to 16x18 AWG conductors, 125 °C, 150 V, 8.0 A, field wireable 16-pin in-line connector, for use with Eurofast (isolated power supply) junctions boxes                          | <p><b>Female</b></p> |
|                 | CK 19-0            | Nickel plated brass, PG 13.5 cable gland, accepts 5-12 mm cable diameter, accepts up to 19x18 AWG conductors, 125 °C, 150 V, 8.0 A, field wireable 19-pin in-line connector, for use with Eurofast (two Signals per port) junctions boxes                           | <p><b>Female</b></p> |
|                 | CK 125-0           | Nickel plated brass, IAC, accepts 3-10 mm cable diameter accepts up to 12x18 AWG conductors, 125 °C, 150 V, 8.0 A, field wireable 12-pin in-line connector  | <p><b>Female</b></p> |

We reserve the right to make technical alterations without prior notice.

Field Wireable

## 12, 16 and 19-Pin Field Wireable In-line Connectors

- For use with Custom Wiring & Junction Boxes
- Convert Hard Wiring into Quick Disconnect
- IEC IP65 Protection



| Connector Style | Male Part Number                    | Features   | Pinout |
|-----------------|-------------------------------------|--|--------|
| <br><br>        | <b>CSS 12-0</b>                     | Nickel plated brass, PG 13.5 cable gland, accepts 5-12 mm cable diameter, accepts up to 12x18 AWG conductor, 125 °C, 300 V, 8.0 A, field wireable 12-pin in-line connector, for use with Minifast®, Eurofast® (single input per port) and Microfast® junctions boxes |        |
|                 | <b>CS 12-0</b>                      | Nickel plated brass, PG 11 cable gland, accepts 4-10 mm cable diameter, accepts up to 12x18 AWG conductor, 125 °C, 300 V, 8.0 A, field wireable 12-pin in-line connector, for use with Minifast, Eurofast (single input per port) and Microfast junctions boxes      |        |
|                 | <b>CSS 16-0</b><br><b>CS 16-0</b>   | Nickel plated brass, PG 13.5 cable gland, accepts 5-12 mm cable diameter, accepts up to 16x18 AWG conductor, 125 °C, 150 V, 8.0 A, field wireable 16-pin in-line connector, for use with Eurofast (isolated power supply) junctions boxes                            |        |
|                 | <b>CSS 19-0</b><br><b>CS 19-0</b>   | Nickel plated brass, PG 13.5 cable gland, accepts 5-12 mm cable diameter, accepts up to 19x18 AWG conductor, 125 °C, 150 V, 8.0 A, field wireable 19-pin in-line connector, for use with Eurofast (two signals per port) junctions boxes                             |        |
|                 | <b>CSS 125-0</b><br><b>CS 125-0</b> | Nickel plated brass, IAC, accepts 3-10 mm cable diameter, accepts up to 12x18 AWG conductor, 125 °C, 150 V, 8.0 A, field wireable 12-pin in-line connector   |        |

We reserve the right to make technical alterations without prior notice.



12, 16 and 19-Pin Field Wireable, Front Mount

- For use with Custom Wiring & Junction Boxes
- Convert Hard Wiring into Quick Disconnect
- IEC IP65 Protection



| Connector Style | Part Number                         | Features   | Pinout            |
|-----------------|-------------------------------------|--|-------------------|
|                 | <b>CKF 12-0</b><br><b>CKFL 12-0</b> | Nickel plated brass, accepts up to 12x18 AWG conductor, 125 °C, 300 V, 8.0 A, field wireable 12-pin receptacle, for use with Minifast®, Eurofast® (single input per port) and Microfast® junctions boxes | <b>Female</b><br> |
|                 | <b>CKF 16-0</b><br><b>CKFL 16-0</b> | Nickel plated brass, accepts up to 16x18 AWG conductor, 125 °C, 150 V, 8.0 A, field wireable 16-pin receptacle, for use with Eurofast (isolated power supply) junctions boxes                            | <b>Female</b><br> |
|                 | <b>CKF 19-0</b><br><b>CKFL 19-0</b> | Nickel plated brass, accepts up to 19x18 AWG conductor, 125 °C, 150 V, 8.0 A, field wireable 19-pin receptacle, for use with Eurofast (two signals per port) junctions boxes                             | <b>Female</b><br> |
|                 | <b>CSF 12-0</b><br><b>CSFL 12-0</b> | Nickel plated brass, accepts up to 12x18 AWG conductor, 125 °C, 300 V, 8.0 A, field wireable 12-pin receptacle, for use with Minifast, Eurofast (single input per port) and Microfast junctions boxes    | <b>Male</b><br>   |
|                 | <b>CSF 16-0</b><br><b>CSFL 16-0</b> | Nickel plated brass, accepts up to 16x18 AWG conductor, 125 °C, 150 V, 8.0 A, field wireable 16-pin receptacle, for use with Eurofast (isolated power supply) junctions boxes                            | <b>Male</b><br>   |
|                 | <b>CSF 19-0</b><br><b>CSFL 19-0</b> | Nickel plated brass, accepts up to 19x18 AWG conductor, 125 °C, 150 V, 8.0 A, field wireable 19-pin receptacle, for use with Eurofast (two signals per port) junctions boxes                             | <b>Male</b><br>   |

We reserve the right to make technical alterations without prior notice.

Field Wireable

12, 16 and 19-Pin Field Wireable Receptacles, Rear Mount

- Convert Hard Wiring into Quick Disconnect
- For use with Custom Wiring
- IEC IP65 Protection



| Connector Style | Part Number | Features  | Pinout               |
|-----------------|-------------|---|----------------------|
|                 | CKFD 12-0   | Nickel plated brass, accepts up to 12x18 AWG conductor, 125 °C, 300 V, 8.0 A, field wireable 12-pin receptacle, for use with field wiring and custom panel wiring | <p><b>Female</b></p> |
|                 | CKFD 16-0   | Nickel plated brass, accepts up to 16x18 AWG conductor, 125 °C, 150 V, 8.0 A, field wireable 16-pin receptacle, for use with field wiring and custom panel wiring | <p><b>Female</b></p> |
|                 | CKFD 19-0   | Nickel plated brass, accepts up to 19x18 AWG conductor, 125 °C, 150 V, 8.0 A, field wireable 19-pin receptacle, for use with field wiring and custom panel wiring | <p><b>Female</b></p> |
|                 | CSFD 12-0   | Nickel plated brass, accepts up to 12x18 AWG conductor, 125 °C, 300 V, 8.0 A, field wireable 12-pin receptacle, for use with field wiring and custom panel wiring | <p><b>Male</b></p>   |
|                 | CSFD 16-0   | Nickel plated brass, accepts up to 16x18 AWG conductor, 125 °C, 150 V, 8.0 A, field wireable 16-pin receptacle, for use with field wiring and custom panel wiring | <p><b>Male</b></p>   |

We reserve the right to make technical alterations without prior notice.

Conduit Adapters, 1 Port

- Attaches to Standard Crouse-Hinds 3/4" Form 8, Mark 9 Conduit Bodies for transition to 12 and 19-Pin Multifast Connectors
- Gasket and 8-32 x 1/2 Mounting Screws included
- IP67 Protection (only when all receptacles are mated or covered with plugs)
- Terminal Strips accept up to 14 AWG Wires



| Housing Style | Part Number | Features   | Wiring Diagram |
|---------------|-------------|--|----------------|
|               | CA-1/CK 12  | Nylon housing, nickel plated brass receptacle housing, 80 °C, 300 V, 4 A, attaches to standard conduit body for transition to 12-pin Multifast connector |                |
|               | CA-1/CKV 12 | Nylon housing, stainless steel receptacle housing 80 °C, 300 V, 4 A, attaches to standard conduit body for transition to 12-pin Multifast connector      |                |
|               | CA-1/CK 19  | Nylon housing, nickel plated brass receptacle housing, 80 °C, 150 V, 4 A, attaches to standard conduit body for transition to 19-pin Multifast connector |                |
|               | CA-1/CKV 19 | Nylon housing, stainless steel receptacle housing, 80 °C, 150 V, 4 A, attaches to standard conduit body for transition to 19-pin Multifast connector     |                |

We reserve the right to make technical alterations without prior notice.

Adapters

Pinouts

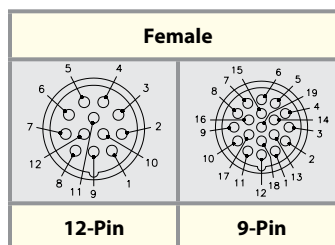

Accessories

- Field Wireable Assembly Tools
- Closure Caps

| Housing Style | Part Number | Features   |
|---------------|-------------|--|
|               | CK-TOOL     | Tool to aid assembly of all M23 Multifast field wireables with female threads  |
|               | CKF-TOOL    | Tool to aid assembly of all M23 Multifast field wireables with male threads  |
|               | CS-CC       | Nickel plated brass Neoprene gasket, closure caps for Multifast cordset connectors                                   |
|               | CK-CC       | Nickel plated brass Neoprene gasket, closure caps for Multifast receptacles (CSF and CKF) and CSS cordset connectors |

We reserve the right to make technical alterations without prior notice.

|   |           |
|---|-----------|
| <b>Part Number Keys</b>                           | <b>J3</b> |
| <b>Cordset and Receptacle Specifications</b>      | <b>J4</b> |
| <b>Cordset and Receptacle Selection Matrix</b>    | <b>J4</b> |
| <b>Cordset and Receptacle Dimensions</b>          | <b>J5</b> |
| <b>Cordset and Receptacle Pinouts</b>             | <b>J5</b> |
| <b>Closure Caps</b>                               | <b>J6</b> |
| <b>Powerlok and Disconnect Switch Accessories</b> | <b>J7</b> |

**Features**

- Ideal for small motor applications
- 3 and 4-pin
- 14 AWG conductors
- Up to 15 Amp, 600 Volt rated
- Dual rated TC-ER and STOOW PVC cable
- "/S4000" TC-ER only PVC cable option available
- NEMA 1, 3, 4, 6P protection
- IEC IP67 protection



**Application Considerations**

**Installation Guidelines**

Turck's Powerfast products are easy to install by following a few simple guidelines:

- It is important to know the electrical requirements of the application and to select a cordset that has the proper amperage and voltage ratings for the application.
- Cables must be supported to prevent movement on the equipment. Per NFPA 79, the cable must be supported every 12 inches in a non-vertical run, every 36 inches in a vertical run and every 18 inches when suspended in air. The cable should also be supported at any connection points or terminations.
- The cordsets are not intended for disconnection under load. Turck offers Powerlok fittings that prevent the possibility of disconnection. These fittings are not required for use, but can be used as a precautionary measure.
- Power should never be supplied from the male connector. The source of power should always be supplied from the female connector.
- Use Turck closure caps to protect connectors from damage or dirt when not connected.

Note: Consult NFPA 79 (Electrical Standard for Industrial Machinery) for required over current protection of conductors and other selection and installation guidelines for industrial machine applications.

**Cable Options**

Turck offers multiple cable options for the Powerfast products. The majority of Turck's Powerfast products use cables that carry a tray rated, exposed run (TC-ER) approval. Select Turck Powerfast products may carry an additional STOOW cable approval, although versions that carry the STOOW and TC-ER approval are also available as TC-ER only.

Both the STOOW/TC-ER cable and the TC-ER only cable version are premium cable offerings. However, the TC-ER only version has a slightly reduced cable outer diameter. This feature offers more flexibility and is a more cost effective solution. This cable option can be designated by adding a "/S4000" to the end of the part description where applicable.

We reserve the right to make technical alterations without prior notice.

**Estimated hp ratings for D-Size Powerfast**

(Based on 85% motor efficiency and 90% power factor.)

| Single Phase (2 Current Carrying Conductors) |        |                |                 |            |
|--|--------|----------------|-----------------|------------|
| Pin Count                                    | AWG    | Current (amps) | Voltage (volts) | Power (hp) |
| 3-pin  | 10 AWG | 30             | 230             | 7          |
|  |        |                | 460             | 14         |
|  |        |                | 575             | 17         |
|  | 12 AWG | 25             | 230             | 5          |
|  |        |                | 460             | 11         |
|  |        |                | 575             | 14         |
|  | 14 AWG | 18             | 230             | 4          |
|  |        |                | 460             | 8          |
|  |        |                | 575             | 10         |

| Three Phase (3 Current Carrying Conductors) |        |                |                 |            |
|---|--------|----------------|-----------------|------------|
| Pin Count                                   | AWG    | Current (amps) | Voltage (volts) | Power (hp) |
| 4-pin                                       | 10 AWG | 25             | 230             | 10         |
|   |        |                | 460             | 20         |
|   |        |                | 575             | 25         |
|   | 12 AWG | 20             | 230             | 8          |
|   |        |                | 460             | 16         |
|   |        |                | 575             | 20         |
|   | 14 AWG | 15             | 230             | 6          |
|   |        |                | 460             | 12         |
|   |        |                | 575             | 15         |

Note: These tables are theoretical values and are for reference only. Values will vary based on load conditions, as well as condition, age and type of motor. Please consult a qualified electrician for specific product sizing requirements. Current limits for conductor gauge size taken from NFPA 79 2007 edition.

## 2 and 3-Wire Receptacles, Front Mount, 1/4-18 NPT Threads

Part Number Keys are to assist in IDENTIFICATION ONLY. Consult factory for catalog items not identified.

|   |  |          |          |  |   |           |             |
|---|--|----------|----------|--|---|-----------|-------------|
| <b>M23 Multifast® Receptacle</b>  | <b>R</b>   | <b>K</b> | <b>M</b> | <b>34</b>  | - | <b>*M</b> | <b>/S..</b> |
| <b>Gender</b>   | K = female connector, female threads<br>S = male connector, male threads<br>Y = male connector, female threads |          |          | <b>Varieties</b><br>(blank) = TC-ER ST00W PVC cable jacket<br>/S4000 = TC-ER PVC cable jacket<br>/S .. = consult factory, special<br>/CS .. = consult factory, special |   |           |             |
| <b>Coupling Nut Material</b>  | (blank) = nylon<br>M = nickel plated brass<br>V = 316 stainless steel (hex)                                    |          |          | <b>Length in Meters</b>  |   |           |             |
|   |  |          |          | <b>Number of Wires / AWG / Color Codes</b><br>34 = 3x14 AWG GN, BK, WH<br>44 = 4x14 AWG BK, WH, RD, GN   |   |           |             |
| <b>Insertion Point of Extension Cable Second Prefix*</b><br>* Male connector listed first, female connector second<br>Example: <b>RSM RKM 44-2M</b> |  |          |          |  |   |           |             |

### Extension Examples

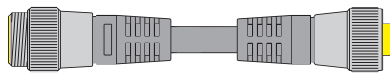

**R S M**    **R K M**    **44** - **\*M**

## A-Size 7/8" Powerfast Receptacle Part Number Key

|   |  |          |          |  |   |   |           |             |             |
|---|--|----------|----------|--|---|---|-----------|-------------|-------------|
| <b>A-Size 7/8" Powerfast Receptacle</b> | <b>R</b>   | <b>K</b> | <b>F</b> | <b>V</b>   | <b>34</b>   | - | <b>*M</b> | <b>/NPT</b> | <b>/S..</b> |
| <b>Gender</b>                           | K = female connector, female threads<br>S = male connector, male threads<br>X = female connector, male threads |          |          |  | <b>Varieties</b><br>/S .. = consult factory, special<br>/CS .. = consult factory, special |   |           |             |             |
| <b>A-Size 7/8" Powerfast Receptacle</b> |  |          |          |  | <b>Connection Thread</b><br>/NPT = 1/2-14 NPT threads<br>/M20 = M20 x 1.5 threads         |   |           |             |             |
| <b>Housing Material</b>                 | (blank) = nickel plated brass<br>K = nylon<br>V = 316 stainless steel  |          |          |  | <b>Length in Meters</b>   |   |           |             |             |
|   |  |          |          | <b>Number of Wires / AWG / Color Codes</b><br>34 = 3x14 AWG GN, BK, WH<br>44 = 4x14 AWG BK, WH, RD, GN |   |   |           |             |             |

## A-Size 7/8" Powerfast Cordset Specifications

### Mechanical

|                                  |                                      |
|----------------------------------|--------------------------------------|
| <b>Mold material/color:</b>      | PVC/Black                            |
| <b>Contact carrier material:</b> | PVC                                  |
| <b>Coupling nut material:</b>    |                                      |
| Standard:                        | Nickel plated brass                  |
| Additional options:              | Nylon<br>316 stainless steel         |
| <b>Environmental protection:</b> | NEMA 1, 3, 4, 6P and IEC IP67        |
| <b>Temperature rating:</b>       | -40 °C to +90 °C (-40 °F to +194 °F) |

### Electrical

|                                     |  |
|-------------------------------------|--|
| <b>Contact material:</b>            | Brass or copper with gold plating                |
| <b>Cable jacket material/color:</b> |  |
| Standard:                           | TC-ER STOOW TPE/Black                            |
| Additional options:                 | TC-ER TPE or<br>TC-ER PVC/Black (/S4000 version) |
| <b>Ratings:</b>                     | 15 Amps, 600 VAC                                 |



## A-Size 7/8" Powerfast Receptacle Part Number Key

### Mechanical

|                                  |                                       |
|----------------------------------|---------------------------------------|
| <b>Contact carrier material:</b> | PVC                                   |
| <b>Housing material/plating:</b> |                                       |
| Standard:                        | Nickel plated brass                   |
| Additional options:              | Nylon<br>316 stainless steel          |
| <b>Environmental protection:</b> | NEMA 1, 3, 4, 6P and IEC IP67         |
| <b>Temperature rating:</b>       | -40 °C to +105 °C (-40 °F to +221 °F) |

### Electrical

|                                     |                                   |
|-------------------------------------|-----------------------------------|
| <b>Contact material:</b>            | Brass or copper with gold plating |
| <b>Cable jacket material/color:</b> | PVC                               |
| <b>Ratings:</b>                     | 15 Amps, 600 VAC                  |



## A-Size 7/8" Powerfast Cordset Selection Matrix

|      |     |                | 1               | 2             | 3                  | 4                |
|------|-----|----------------|-----------------|---------------|--------------------|------------------|
|      |     |                | Straight Female | Straight Male | Right Angle Female | Right Angle Male |
| Pins | AWG | Current Rating | TC-ER STOOW     | TC-ER STOOW   | TC-ER STOOW        | TC-ER STOOW      |
| 3    | 14  | 15             | RKM 34-*M       | RSM 34-*M     |                    |                  |
| 4    | 14  | 15             | RKM 44-*M       | RSM 44-*M     |                    |                  |

| Pins | AWG | Current Rating | TC-ER           | TC-ER           | TC-ER           | TC-ER           |
|------|-----|----------------|-----------------|-----------------|-----------------|-----------------|
| 3    | 14  | 15             | RKM 34-*M/S4000 | RSM 34-*M/S4000 | WKM 34-*M/S4000 | WSM 34-*M/S4000 |
| 4    | 14  | 15             | RKM 44-*M/S4000 | RSM 44-*M/S4000 | WKM 44-*M/S4000 | WSM 44-*M/S4000 |

## A-Size 7/8" Powerfast Receptacle Selection Matrix

|      |     |                | 5                          | 6                          | 7                   | 8                   |
|------|-----|----------------|----------------------------|----------------------------|---------------------|---------------------|
|      |     |                | Female                     | Male                       | Female              | Male                |
| Pins | AWG | Current Rating | 1/2-14 NPT Mounting Thread | 1/2-14 NPT Mounting Thread | M20 Mounting Thread | M20 Mounting Thread |
| 3    | 14  | 15             | RKF 34-*M/NPT              | RSF 34-*M/NPT              | RSF 34-*M/M20       | RKF 34-*M/M20       |
| 4    | 14  | 15             | RKF 44-*M/NPT              | RSF 44-*M/NPT              | RSF 44-*M/M20       | RKF 44-*M/M20       |

We reserve the right to make technical alterations without prior notice.



A-Size 7/8" Powerfast Cordset and Receptacle Dimensions

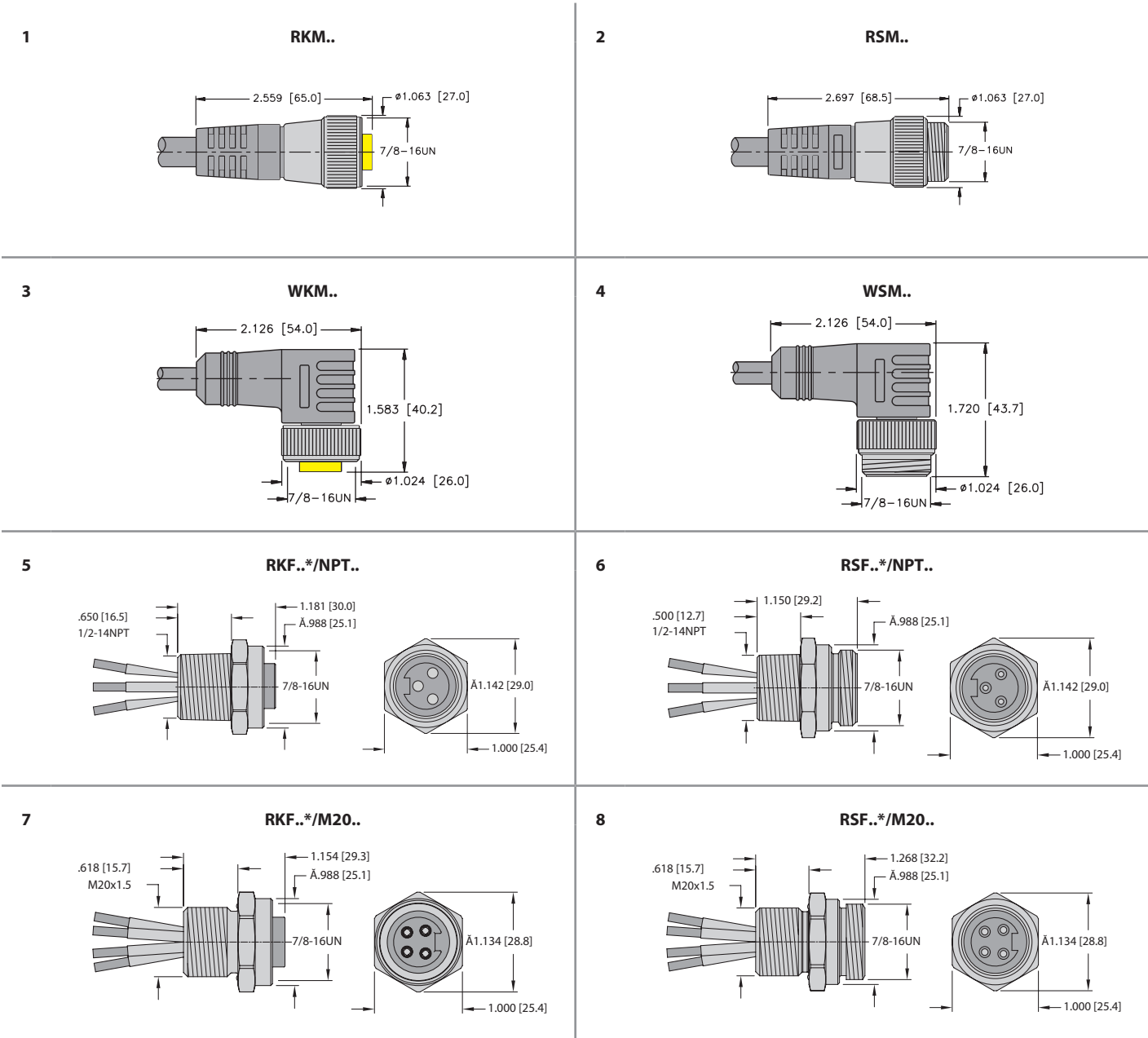

A-Size 7/8" powerfast

A-Size 7/8" Powerfast Cordset and Receptacle Pinouts

| 3-Pin  |      | Pinouts                 | 4-Pin  |      | Pinouts                          |
|--------|------|-------------------------|--------|------|----------------------------------|
| Female | Male |                         | Female | Male |                                  |
|        |      | 1. GN<br>2. BK<br>3. WH |        |      | 1. BK<br>2. WH<br>3. RD<br>4. GN |

## A-Size 7/8" Powerfast Closure Cap Selection Matrix

|                     |           | 9                                      | 10                                       | 11                        | 12                          | 13                                     | 14                                       |
|---------------------|-----------|--|--|---------------------------|-----------------------------|--|--|
|                     |           | Mates to male cordsets and receptacles | Mates to female cordsets and receptacles | Mates to male receptacles | Mates to female receptacles | Mates to male cordsets and receptacles | Mates to female cordsets and receptacles |
| Material            | Thread    | 6" SS Loop Lanyard                     | 6" SS Loop Lanyard                       | 6" SS Lanyard with Eyelet | 6" SS Lanyard with Eyelet   | No Lanyard                             | No Lanyard                               |
| Nickel Plated Brass | 7/8-16 UN | RKM-CC                                 | RSM-CC                                   | RKF-CC                    | RSF-CC                      | RKF-MC                                 | RSF-MC                                   |
| Stainless Steel     | 7/8-16 UN | RKMV-CC                                | RSMV-CC                                  | RKfV-CC                   | RSfV-CC                     | RKFV-MC                                | RSfV-MC                                  |

## A-Size 7/8" Powerfast Closure Cap Dimensions

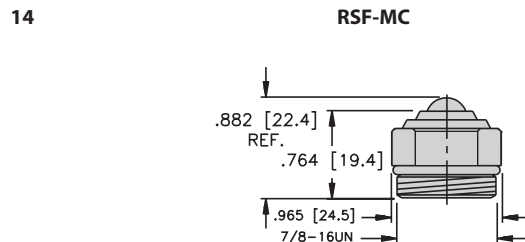
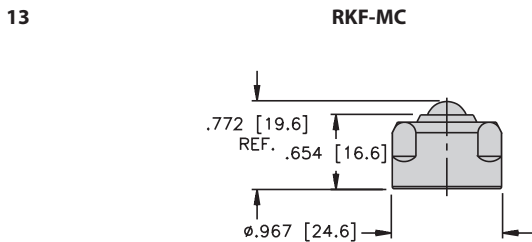
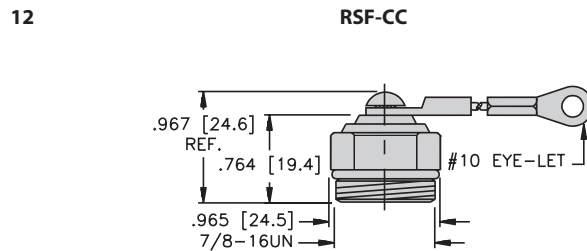
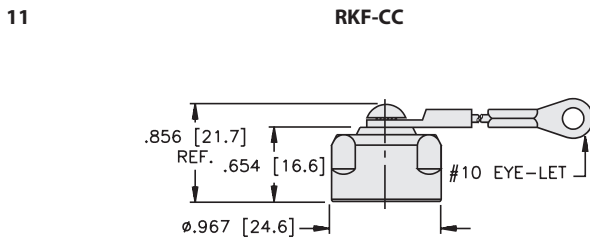
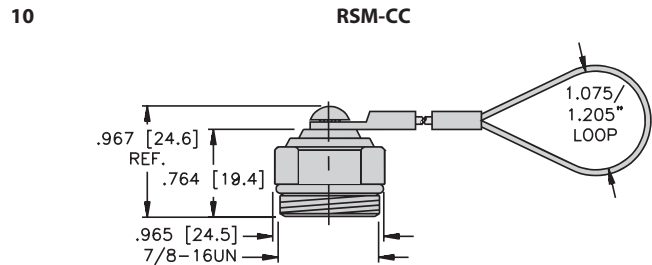
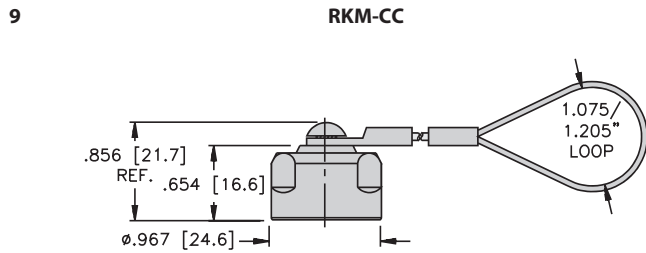

## A-Size 7/8" Powerlok

| Part Number         | Application  |
|---------------------|--|
| <b>LOCK-A POWER</b> | Nylon locking guard for straight A-Size Powerfast connectors |

A-Size Powerlok Open



A-Size Powerlok Closed



## A-Size Powerfast Disconnect Switch Selection Matrix

We reserve the right to make technical alterations without prior notice.



| Pins | AWG | Current Rating | Standard      | M12 Auxiliary Output |
|------|-----|----------------|---------------|----------------------|
| 3    | 14  | 15 Amps        | RSF RKF 34/DS | RSF RKF 34/DS/AUX    |
| 4    | 14  | 15 Amps        | RSF RKF 44/DS | RSF RKF 44/DS/AUX    |

A-Size 7/8" powerfast



|  |            |
|--|------------|
| <b>Part Number Keys</b>  | <b>J10</b> |
| <b>Cordset, Receptacle and Field Wireable Specifications</b>   | <b>J12</b> |
| <b>Cordset, Receptacle and Field Wireable Selection Matrix</b> | <b>J13</b> |
| <b>Cordset, Receptacle and Field Wireable Dimensions</b>       | <b>J15</b> |
| <b>Cordset, Receptacle and Field Wireable Pinouts</b>          | <b>J16</b> |
| <b>Tee Specifications</b>                                      | <b>J16</b> |
| <b>Tee Selection Matrix</b>                                    | <b>J17</b> |
| <b>Tee Dimensions</b>  | <b>J20</b> |
| <b>Power Reducer Specifications</b>                            | <b>J23</b> |
| <b>Power Reducer Selection Matrix</b>                          | <b>J23</b> |
| <b>Power Reducer Dimensions</b>                                | <b>J23</b> |
| <b>Tee and Power Reducer Wiring Diagrams</b>                   | <b>J24</b> |
| <b>Tee and Power Reducer Pinouts</b>                           | <b>J25</b> |
| <b>Closure Caps</b>  | <b>J26</b> |
| <b>Powerlok Accessories</b>                                    | <b>J26</b> |

**Features**

- Ideal for small motor applications
- 3 and 4-pin
- 14 AWG conductors
- Up to 15 Amp, 600 Volt rated
- Dual rated TC-ER and STOOW PVC cable
- "/S4000" TC-ER only PVC cable option available
- NEMA 1, 3, 4, 6P protection
- IEC IP67 protection



D-Size 1 3/8" powerfast

# D-Size 1 3/8" powerfast Connectivity



## D-Size 1 3/8" Powerfast Cordset Part Number Key

Part Number Keys are to assist in IDENTIFICATION ONLY. Consult factory for catalog items not identified.

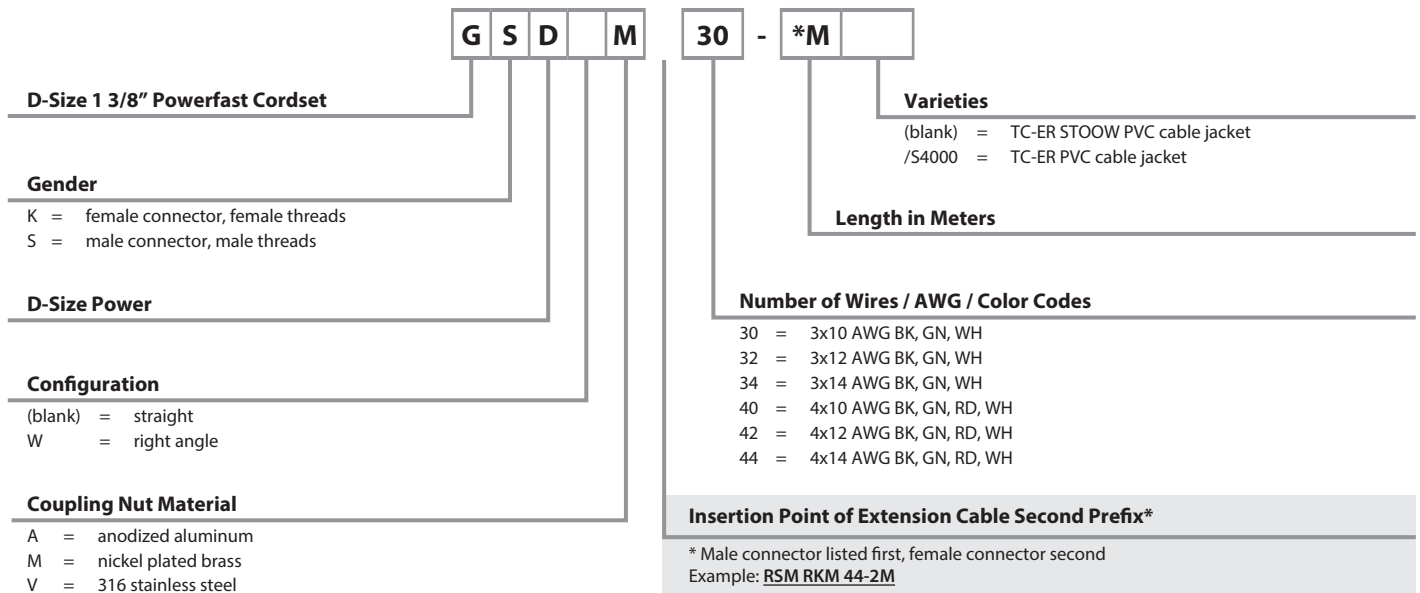

### Extension Examples

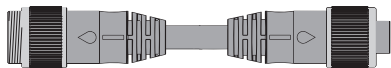

## D-Size 1 3/8" Powerfast Receptacle Part Number Key

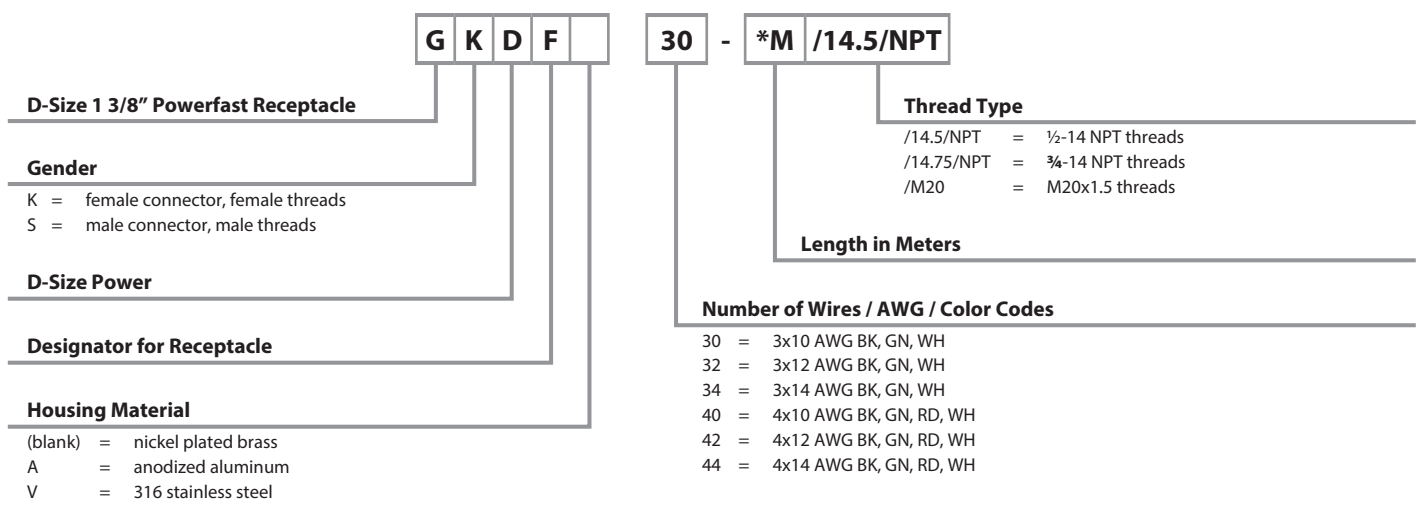

## 2 and 3-Wire Receptacles, Front Mount, 1/4-18 NPT Threads

Part Number Keys are to assist in IDENTIFICATION ONLY. Consult factory for catalog items not identified.

**D-Size (1 3/8") Powerfast Tees**

**Trunk(1) Identifier**  
 K = female connector  
 S = male connector

**Coupling Nut Material**  
 A = anodized aluminum  
 M = nickel plated brass  
 V = 316 stainless steel

**D-Size (1 3/8") Powerfast Tees**

**Trunk(2) and Drop(3) Identifiers**  
 2GKDM = female trunk(2) and female drop(3)  
 GSDM/GKDM = male trunk(2) and female drop(3)  
 GKDM/T = female trunk (2) and cable drop(3)  
 GKDM/RKM = female trunk(2) and female A-Size Power drop(3)  
 GKDM/BKM = female trunk(2) and female M16 Power drop(3)

**30 - \* - /S..**

**Varieties**  
 /S = consult factory, special  
 /CS = consult factory, special  
 /S4000 = designates TC-ER cable

**Length in Meters**

**Number of Wires / AWG / Color Codes**  
 30 = 3x10 AWG BK, GN, WH  
 32 = 3x12 AWG BK, GN, WH  
 34 = 3x14 AWG BK, GN, WH  
 40 = 4x10 AWG BK, GN, RD, WH  
 42 = 4x12 AWG BK, GN, RD, WH  
 44 = 4x14 AWG BK, GN, RD, WH

Note: Only one male connector per tee available.  
 Standard female coupling nut material for A-Size Power drop and M16 Power drop is nickel plated brass.

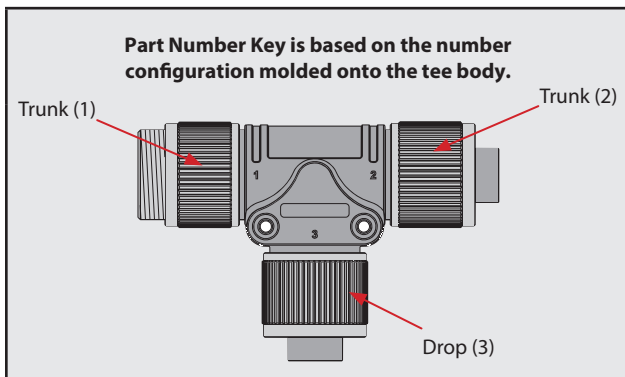

**Tee Examples**

**G S D M / 2 G K D M 30**

**G S D M / G K D M / R K M 44 - \***

D-Size 1 3/8" powerfast

# D-Size 1 3/8" powerfast Connectivity



## D-Size 1 3/8" Powerfast Cordset Specifications

### Mechanical

|                                  |   |
|----------------------------------|---|
| <b>Mold material/color:</b>      | PVC/Black                                     |
| <b>Housing material/plating:</b> | PVC   |
| Standard:                        | Nickel plated brass                           |
| Additional options:              | Anodized aluminum<br>316 stainless steel      |
| <b>Environmental protection:</b> | NEMA 1, 3, 4, 6P and<br>IEC IP67, IP68, IP69K |
| <b>Temperature rating:</b>       | -40 °C to +90 °C (-40 °F to +194 °F)          |

### Electrical

|                                     |                                   |
|-------------------------------------|-----------------------------------|
| <b>Contact material:</b>            | Brass or copper with gold plating |
| <b>Cable jacket material/color:</b> |                                   |
| Standard:                           | TC-ER STOOW PVC/Black             |
| Additional options:                 | TC-ER PVC/Black (/S4000 version)  |
| <b>Ratings:</b>                     | 15-30 Amps, 600 VAC               |



## D-Size 1 3/8" Powerfast Receptacle Specifications

### Mechanical

|                                  |   |
|----------------------------------|---|
| <b>Contact carrier material:</b> | PVC   |
| <b>Housing material/plating:</b> |   |
| Standard:                        | Nickel plated brass                           |
| Additional options:              | Anodized aluminum<br>316 stainless steel      |
| <b>Environmental protection:</b> | NEMA 1, 3, 4, 6P and<br>IEC IP67, IP68, IP69K |
| <b>Temperature rating:</b>       | -40 °C to +105 °C (-40 °F to +221 °F)         |

### Electrical

|                              |                                   |
|------------------------------|-----------------------------------|
| <b>Contact material:</b>     | Brass or copper with gold plating |
| <b>Conductor insulation:</b> | PVC                               |
| <b>Ratings:</b>              | 15-30 Amps, 600 VAC               |



## D-Size 1 3/8" Powerfast Field Wireable Specifications

### Mechanical

|                                  |  |
|----------------------------------|--|
| <b>Housing material/color:</b>   | Nylon/Black                              |
| <b>Contact carrier material:</b> | PVC                                      |
| <b>Coupling nut material:</b>    |  |
| Standard:                        | Nickel plated brass                      |
| Additional options:              | Anodized aluminum<br>316 stainless steel |
| <b>Environmental protection:</b> | NEMA 6P and IEC IP67                     |
| <b>Temperature rating:</b>       | -40 °C to +90 °C (-40 °F to +194 °F)     |





### Electrical

|                          |                                   |
|--------------------------|-----------------------------------|
| <b>Contact material:</b> | Brass or copper with gold plating |
| <b>Ratings:</b>          | Up to 30 Amps, 600 VAC            |

We reserve the right to make technical alterations without prior notice.



## D-Size 1 3/8" Powerfast Cordset Selection Matrix

|      |     |                | 1  | 2  | 3  | 4  |
|------|-----|----------------|---|--|---|---|
|      |     |                | Straight Female   | Straight Male  | Right Angle Female  | Right Angle Male  |
| Pins | AWG | Current Rating | TC-ER STOOW   | TC-ER STOOW  | TC-ER STOOW   | TC-ER STOOW   |
| 3    | 10  | 30 Amps        | GKDM 30-*M  | GSDM 30-*M   | GKDWM 30-*M   | GSDWM 30-*M   |
|      | 12  | 25 Amps        | GKDM 32-*M  | GSDM 32-*M   | GKDWM 32-*M   | GSDWM 32-*M   |
|      | 14  | 18 Amps        | GKDM 34-*M  | GSDM 34-*M   | GKDWM 34-*M   | GSDWM 34-*M   |
| 4    | 10  | 25 Amps        | GKDM 40-*M  | GSDM 40-*M   | GKDWM 40-*M   | GSDWM 40-*M   |
|      | 12  | 20 Amps        | GKDM 42-*M  | GSDM 42-*M   | GKDWM 42-*M   | GSDWM 42-*M   |
|      | 14  | 15 Amps        | GKDM 44-*M  | GSDM 44-*M   | GKDWM 44-*M   | GSDWM 44-*M   |

| Pins | AWG | Current Rating | TC-ER            | TC-ER            | TC-ER             | TC-ER             |
|------|-----|----------------|------------------|------------------|-------------------|-------------------|
| 3    | 10  | 30 Amps        | GKDM 30-*M/S4000 | GSDM 30-*M/S4000 | GKDWM 30-*M/S4000 | GSDWM 30-*M/S4000 |
|      | 12  | 25 Amps        | GKDM 32-*M/S4000 | GSDM 32-*M/S4000 | GKDWM 32-*M/S4000 | GSDWM 32-*M/S4000 |
|      | 14  | 18 Amps        | GKDM 34-*M/S4000 | GSDM 34-*M/S4000 | GKDWM 34-*M/S4000 | GSDWM 34-*M/S4000 |
| 4    | 10  | 25 Amps        | GKDM 40-*M/S4000 | GSDM 40-*M/S4000 | GKDWM 40-*M/S4000 | GSDWM 40-*M/S4000 |
|      | 12  | 20 Amps        | GKDM 42-*M/S4000 | GSDM 42-*M/S4000 | GKDWM 42-*M/S4000 | GSDWM 42-*M/S4000 |
|      | 14  | 15 Amps        | GKDM 44-*M/S4000 | GSDM 44-*M/S4000 | GKDWM 44-*M/S4000 | GSDWM 44-*M/S4000 |

See page 15 for dimensional drawings.

- \* Length in meters. Standard cable lengths are 2, 5 and 10 meters. Consult factory for other lengths.  
 Note: Extension cables are available, please consult Part Number Key (page 10).  
 Standard coupling nut material is nickel plated brass. Consult Part Number Key (page 10) for anodized aluminum and 316 stainless steel options.





We reserve the right to make technical alterations without prior notice.



D-Size 1 3/8" powerfast

# D-Size 1 3/8" powerfast Connectivity



## D-Size 1 3/8" Powerfast Receptacle Selection Matrix

| Front Mount |     |                | 5   | 6   | 7   | 8   |
|-------------|-----|----------------|---|---|---|---|
|             |     |                |  |  |  |  |
| Pins        | AWG | Current Rating | 1/2-14 NPT Mounting Thread  | 1/2-14 NPT Mounting Thread  | 3/4-14 NPT Mounting Thread  | 3/4-14 NPT Mounting Thread  |
| 3           | 10  | 30 Amps        | GKDF 30-*M/14.5/NPT   | GSDF 30-*M/14.5/NPT   | GKDF 30-*M/14.75/NPT  | GSDF 30-*M/14.75/NPT  |
|             | 12  | 25 Amps        | GKDF 32-*M/14.5/NPT   | GSDF 32-*M/14.5/NPT   | GKDF 32-*M/14.75/NPT  | GSDF 32-*M/14.75/NPT  |
|             | 14  | 18 Amps        | GKDF 34-*M/14.5/NPT   | GSDF 34-*M/14.5/NPT   | GKDF 34-*M/14.75/NPT  | GSDF 34-*M/14.75/NPT  |
| 4           | 10  | 25 Amps        | GKDF 40-*M/14.5/NPT   | GSDF 40-*M/14.5/NPT   | GKDF 40-*M/14.75/NPT  | GSDF 40-*M/14.75/NPT  |
|             | 12  | 20 Amps        | GKDF 42-*M/14.5/NPT   | GSDF 42-*M/14.5/NPT   | GKDF 42-*M/14.75/NPT  | GSDF 42-*M/14.75/NPT  |
|             | 14  | 15 Amps        | GKDF 44-*M/14.5/NPT   | GSDF 44-*M/14.5/NPT   | GKDF 44-*M/14.75/NPT  | GSDF 44-*M/14.75/NPT  |

| Front Mount |     |                | 9   | 10  |
|-------------|-----|----------------|---|---|
|             |     |                |  |  |
| Pins        | AWG | Current Rating | M20 Mounting Thread   | M20 Mounting Thread   |
| 3           | 10  | 30 Amps        | GKDF 30-*M/M20  | GSDF 30-*M/M20  |
|             | 12  | 25 Amps        | GKDF 32-*M/M20  | GSDF 32-*M/M20  |
|             | 14  | 18 Amps        | GKDF 34-*M/M20  | GSDF 34-*M/M20  |
| 4           | 10  | 25 Amps        | GKDF 40-*M/M20  | GSDF 40-*M/M20  |
|             | 12  | 20 Amps        | GKDF 42-*M/M20  | GSDF 42-*M/M20  |
|             | 14  | 15 Amps        | GKDF 44-*M/M20  | GSDF 44-*M/M20  |

See page 15-16 for dimensional drawings.

\* Length in meters. Standard lead length is 0.5 meters. Consult factory for other lengths.

Note: Standard housing material is nickel plated brass. Consult Part Number Key (page 10) for anodized aluminum and 316 stainless steel options.

We reserve the right to make technical alterations without prior notice.

## D-Size 1 3/8" Powerfast Field Wireable Selection Matrix

| Front Mount |      |                | 11  | 12  |
|-------------|------|----------------|---|---|
|             |      |                |  |  |
| Pins        | AWG  | Current Rating | Screw Terminal  | Screw Terminal  |
| 3           | 8-14 | Up to 30 Amps  | GKDM 30-0   | GSDM 30-0   |
| 4           | 8-14 | Up to 25 Amps  | GKDM 40-0   | GSDM 40-0   |

See page 16 for dimensional drawings.

Note: Standard coupling nut material is nickel plated brass. Consult factory for anodized aluminum and 316 stainless steel options.

**D-Size 1 3/8" Powerfast Cordset Dimensions**

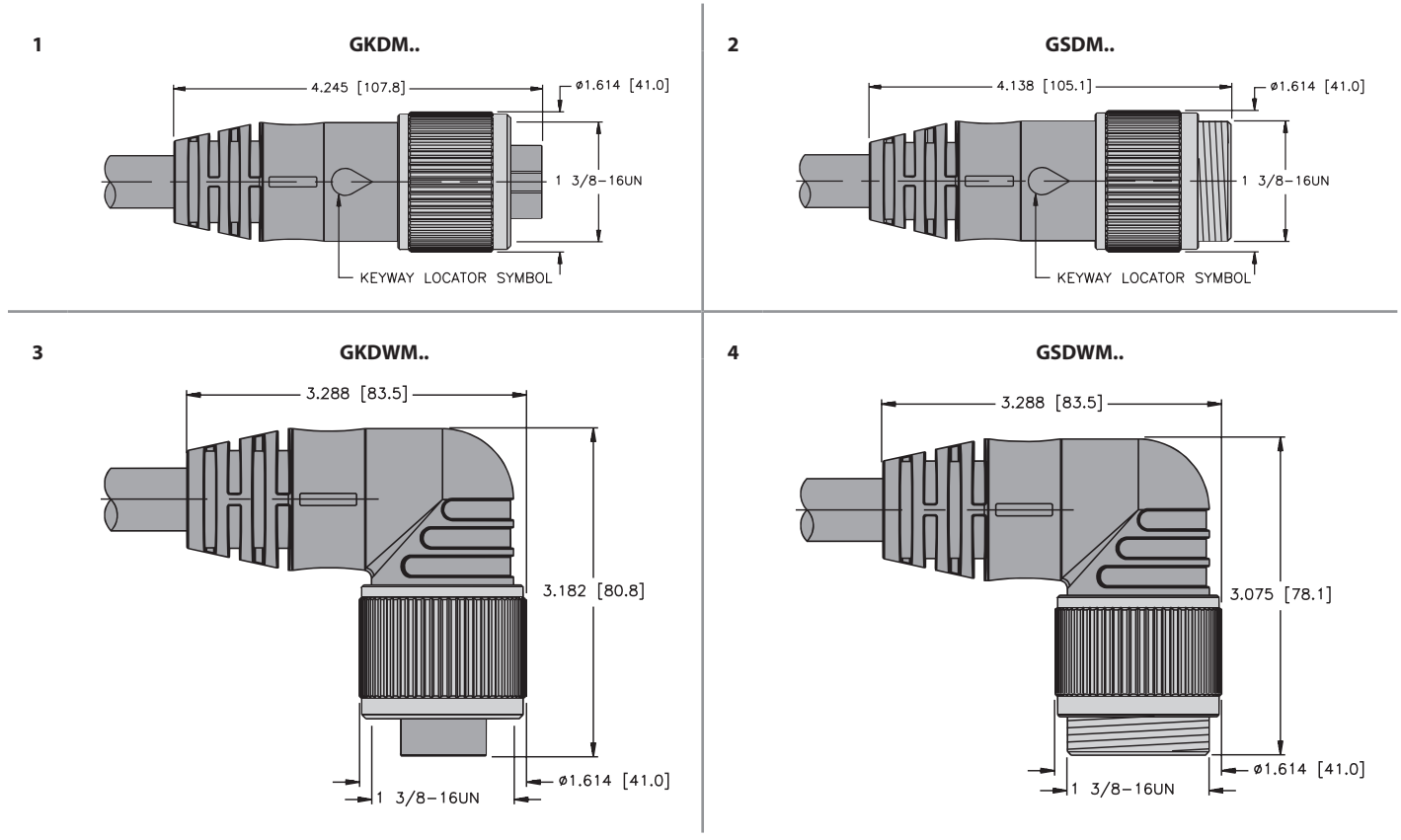

**D-Size 1 3/8" Powerfast Receptacle and Field Wireable Dimensions**

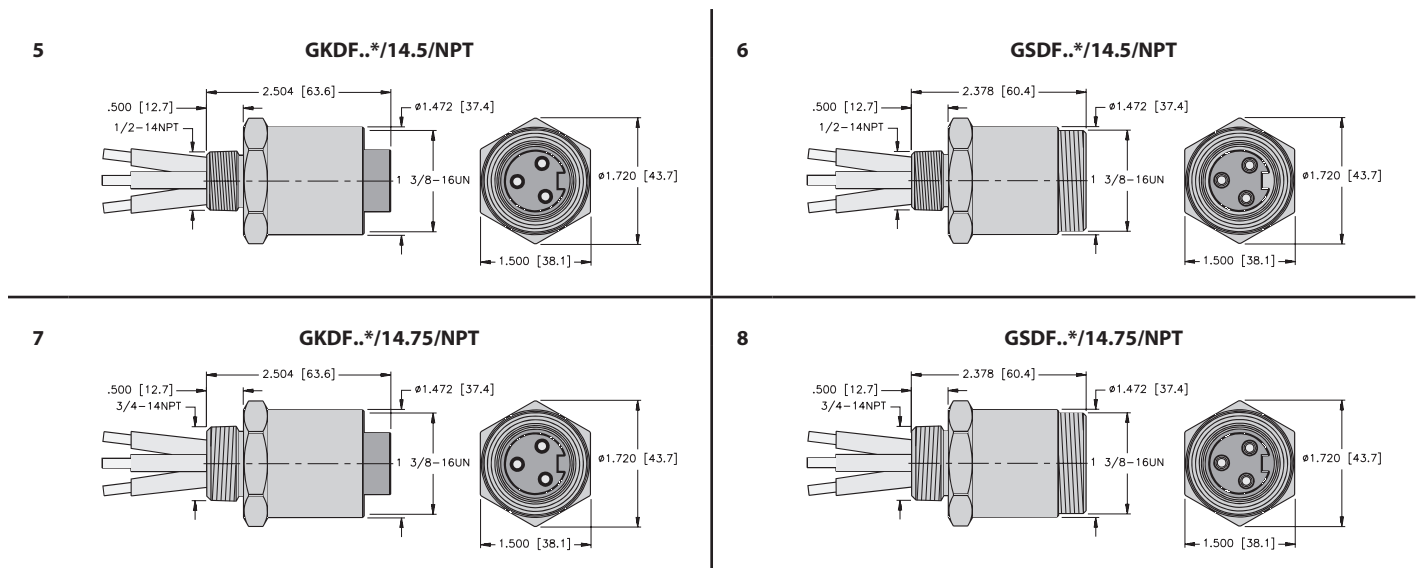

D-Size 1 3/8" powerfast

# D-Size 1 3/8" powerfast Connectivity



## D-Size 1 3/8" Powerfast Receptacle and Field Wireable Dimensions

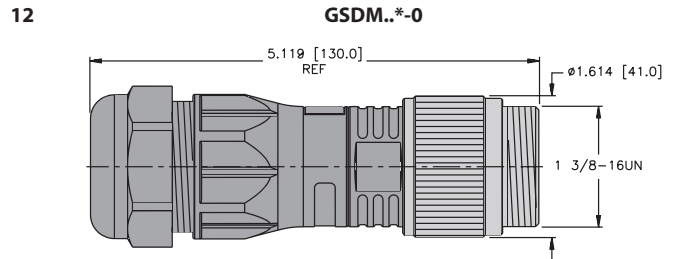
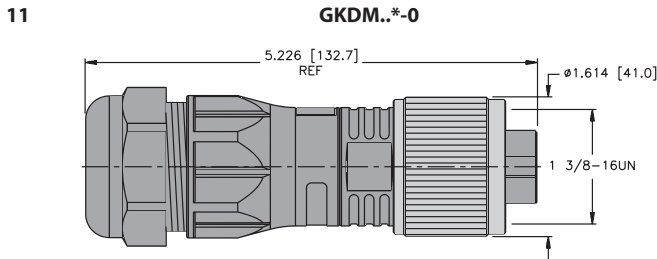
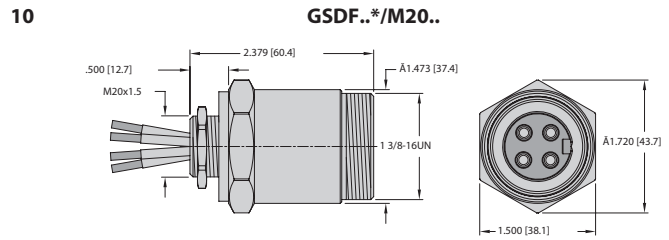
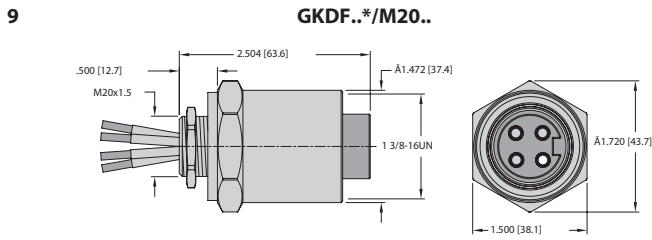

## D-Size 1 3/8" Powerfast Cordset, Receptacle and Field Wireable Pinouts

| 3-Pin  |      | Pinouts                 | 4-Pin  |      | Pinouts                          |
|--------|------|-------------------------|--------|------|----------------------------------|
| Female | Male |                         | Female | Male |                                  |
|        |      | 1. BK<br>2. GN<br>3. WH |        |      | 1. BK<br>2. GN<br>3. RD<br>4. WH |

## D-Size 1 3/8" Powerfast Tee Specifications

### Mechanical

|                                  |  |
|----------------------------------|--|
| <b>Mold material/color:</b>      | PVC/Black                                |
| <b>Contact carrier material:</b> |  |
| <b>Coupling nut material:</b>    |  |
| Standard:                        | Nickel plated brass                      |
| Additional options:              | Anodized aluminum<br>316 stainless steel |

**Environmental protection:** NEMA 1, 3, 4, 6P and IEC IP67, IP68, IP69K

**Temperature rating:** -40 °C to +90 °C (-40 °F to +194 °F)

### Electrical

|                                     |                                   |
|-------------------------------------|-----------------------------------|
| <b>Contact material:</b>            | Brass or copper with gold plating |
| <b>Cable jacket material/color:</b> |                                   |
| Standard:                           | TC-ER STOOW PVC/Black             |
| Additional options:                 | TC-ER PVC/Black (/S4000 version)  |
| <b>Ratings:</b>                     | 15-30 Amps, 600 VAC               |



**Note:** UL approval applies to D-size and A-size power connectors with integral connector drop.

We reserve the right to make technical alterations without prior notice.

## D-Size 1 3/8" Powerfast Tee Selection Matrix

|      |          |                      |                     | 13                             | 14                             | 15                          |
|------|----------|----------------------|---------------------|--------------------------------|--------------------------------|-----------------------------|
|      |          |                      |                     |                                |                                |                             |
|      |          |                      |                     | Integral D-Size Connector Drop | Integral A-Size Connector Drop | Integral M16 Connector Drop |
| Pins | Drop AWG | Trunk Current Rating | Drop Current Rating |                                |                                |                             |
| 3    | 10       | 30 Amps              | 30 Amps             | GSDM/2GKDM 30                  |                                |                             |
|      | 14       | 30 Amps              | 15 Amps             |                                | GSDM/GKDM/RKM 34               | GSDM/GKDM/BKM 34            |
| 4    | 10       | 25 Amps              | 25 Amps             | GSDM/2GKDM 40                  |                                |                             |
|      | 14       | 25 Amps              | 15 Amps             |                                | GSDM/GKDM/RKM 44               | GSDM/GKDM/BKM 44            |

|      |          |                      |                     | 16              | 17                                     | 18                                     | 19                                  |
|------|----------|----------------------|---------------------|-----------------|--|--|-------------------------------------|
|      |          |                      |                     |                 |  |  |                                     |
|      |          |                      |                     | Cable Drop      | Cable Drop With D-Size Power Connector | Cable Drop With A-Size Power Connector | Cable Drop With M16 Power Connector |
| Pins | Drop AWG | Trunk Current Rating | Drop Current Rating | TC-ER STOOW     | TC-ER STOOW                            | TC-ER STOOW                            | TC-ER STOOW                         |
| 3    | 10       | 30 Amps              | 30 Amps             | GSDM/GKDM/T30-* | GSDM/2GKDM 30-*                        |  |                                     |
|      | 12       | 30 Amps              | 25 Amps             | GSDM/GKDM/T32-* | GSDM/2GKDM 32-*                        |  |                                     |
|      | 14       | 30 Amps              | 18 Amps             | GSDM/GKDM/T34-* | GSDM/2GKDM 34-*                        | GSDM/GKDM/RKM 34-*                     | GSDM/GKDM/BKM 34-*                  |
| 4    | 10       | 25 Amps              | 25 Amps             | GSDM/GKDM/T40-* | GSDM/2GKDM 40-*                        |  |                                     |
|      | 12       | 25 Amps              | 20 Amps             | GSDM/GKDM/T42-* | GSDM/2GKDM 42-*                        |  |                                     |
|      | 14       | 25 Amps              | 15 Amps             | GSDM/GKDM/T44-* | GSDM/2GKDM 44-*                        | GSDM/GKDM/RKM 44-*                     | GSDM/GKDM/BKM 44-*                  |

| Pins | Drop AWG | Trunk Current Rating | Drop Current Rating | TC-ER                 | TC-ER                 | TC-ER                     | TC-ER                     |
|------|----------|----------------------|---------------------|-----------------------|-----------------------|---------------------------|---------------------------|
| 3    | 10       | 30 Amps              | 30 Amps             | GSDM/GKDM/T30-*/S4000 | GSDM/2GKDM 30-*/S4000 |                           |                           |
|      | 12       | 30 Amps              | 25 Amps             | GSDM/GKDM/T32-*/S4000 | GSDM/2GKDM 32-*/S4000 |                           |                           |
|      | 14       | 30 Amps              | 18 Amps             | GSDM/GKDM/T34-*/S4000 | GSDM/2GKDM 34-*/S4000 | GSDM/GKDM/RKM 34-*/S4000† | GSDM/GKDM/BKM 34-*/S4000† |
| 4    | 10       | 25 Amps              | 25 Amps             | GSDM/GKDM/T40-*/S4000 | GSDM/2GKDM 40-*/S4000 |                           |                           |
|      | 12       | 25 Amps              | 20 Amps             | GSDM/GKDM/T42-*/S4000 | GSDM/2GKDM 42-*/S4000 |                           |                           |
|      | 14       | 25 Amps              | 15 Amps             | GSDM/GKDM/T44-*/S4000 | GSDM/2GKDM 44-*/S4000 | GSDM/GKDM/RKM 44-*/S4000  | GSDM/GKDM/BKM 44-*/S4000  |

See page 19-20 for dimensional drawings.

\* Length in meters.

† Drop current rating of 15 amps.

Note: Standard coupling nut material is nickel plated brass. Consult Part Number Key (page 11) for anodized aluminum and 316 stainless steel options.



We reserve the right to make technical alterations without prior notice.





D-Size 1 3/8" powerfast

# D-Size 1 3/8" powerfast Connectivity



## D-Size 1 3/8" Powerfast h-Style Tee Selection Matrix

|      |          |                      |                     | 20  | 21   | 22  |
|------|----------|----------------------|---------------------|---|--|---|
|      |          |                      |                     |  |  |  |
|      |          |                      |                     | Integral D-Size Connector Drop  | Integral A-Size Connector Drop   | Integral M16 Connector Drop   |
| Pins | Drop AWG | Trunk Current Rating | Drop Current Rating |   |  |   |
| 3    | 10       | 30 Amps              | 30 Amps             | SH-GSDM/2GKDM 30  |  |   |
|      | 14       | 30 Amps              | 15 Amps             |   | SH-GSDM/GKDM/RKM 34-*  | SH-GSDM/GKDM/BKM 34   |
| 4    | 10       | 25 Amps              | 25 Amps             | SH-GSDM/2GKDM 40  |  |   |
|      | 14       | 25 Amps              | 15 Amps             |   | SH-GSDM/GKDM/RKM 44-*  | SH-GSDM/GKDM/BKM 44   |

|      |          |                      |                     | 23  | 24  | 25   | 26  |
|------|----------|----------------------|---------------------|---|---|--|---|
|      |          |                      |                     |  |  |  |  |
|      |          |                      |                     | Cable Drop  | Cable Drop With D-Size Power Connector  | Cable Drop With A-Size Power Connector   | Cable Drop With M16 Power Connector   |
| Pins | Drop AWG | Trunk Current Rating | Drop Current Rating | TC-ER STOOW   | TC-ER STOOW   | TC-ER STOOW  | TC-ER STOOW   |
| 3    | 10       | 30 Amps              | 30 Amps             | SH-GSDM/GKDM/T30-*  | SH-GSDM/2GKDM 30-*  |  |   |
|      | 12       | 30 Amps              | 25 Amps             | SH-GSDM/GKDM/T32-*  | SH-GSDM/2GKDM 32-*  |  |   |
|      | 14       | 30 Amps              | 18 Amps             | SH-GSDM/GKDM/T34-*  | SH-GSDM/2GKDM 34-*  | SH-GSDM/GKDM/RKM 34-*  |   |
| 4    | 10       | 25 Amps              | 25 Amps             | SH-GSDM/GKDM/T40-*  | SH-GSDM/2GKDM 40-*  |  |   |
|      | 12       | 25 Amps              | 20 Amps             | SH-GSDM/GKDM/T42-*  | SH-GSDM/2GKDM 42-*  |  |   |
|      | 14       | 25 Amps              | 15 Amps             | SH-GSDM/GKDM/T44-*  | SH-GSDM/2GKDM 44-*  | SH-GSDM/GKDM/RKM 44-*  |   |

| Pins | Drop AWG | Trunk Current Rating | Drop Current Rating | TC-ER                    | TC-ER                    | TC-ER                        | TC-ER                        |
|------|----------|----------------------|---------------------|--------------------------|--------------------------|------------------------------|------------------------------|
| 3    | 10       | 30 Amps              | 30 Amps             | SH-GSDM/GKDM/T30-*/S4000 | SH-GSDM/2GKDM 30-*/S4000 |                              |                              |
|      | 12       | 30 Amps              | 25 Amps             | SH-GSDM/GKDM/T32-*/S4000 | SH-GSDM/2GKDM 32-*/S4000 |                              |                              |
|      | 14       | 30 Amps              | 18 Amps             | SH-GSDM/GKDM/T34-*/S4000 | SH-GSDM/2GKDM 34-*/S4000 | SH-GSDM/GKDM/RKM 34-*/S4000† | SH-GSDM/GKDM/BKM 34-*/S4000† |
| 4    | 10       | 25 Amps              | 25 Amps             | SH-GSDM/GKDM/T40-*/S4000 | SH-GSDM/2GKDM 40-*/S4000 |                              |                              |
|      | 12       | 25 Amps              | 20 Amps             | SH-GSDM/GKDM/T42-*/S4000 | SH-GSDM/2GKDM 42-*/S4000 |                              |                              |
|      | 14       | 25 Amps              | 15 Amps             | SH-GSDM/GKDM/T44-*/S4000 | SH-GSDM/2GKDM 44-*/S4000 | SH-GSDM/GKDM/RKM 44-*/S4000  | SH-GSDM/GKDM/BKM 44-*/S4000  |

See page 21-22 for dimensional drawings.

\* Length in meters.

† Drop current rating of 15 amps.

Note: Standard coupling nut material is nickel plated brass. Consult Part Number Key (page 11) for anodized aluminum and 316 stainless steel options.

We reserve the right to make technical alterations without prior notice.

**2 and 3-Wire Receptacles, Front Mount, 1/4-18 NPT Threads**

13

**Integral D-Size Power Connector Drop  
GSDM/2GKDM..**

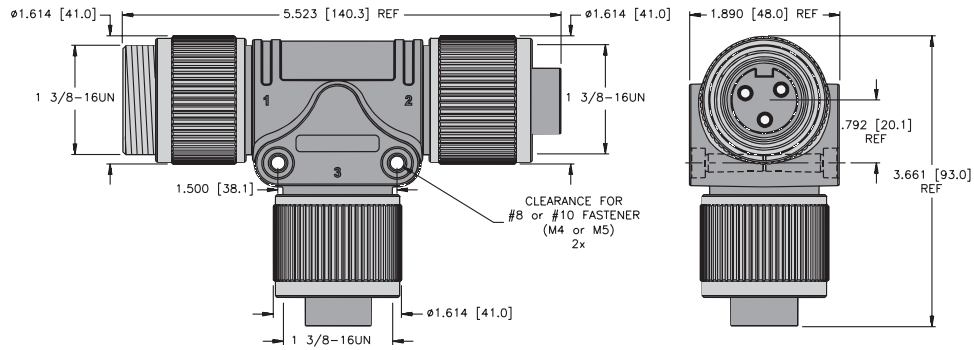

14

**Integral A-Size Power Connector Drop  
GSDM/GKDM/RKM..**

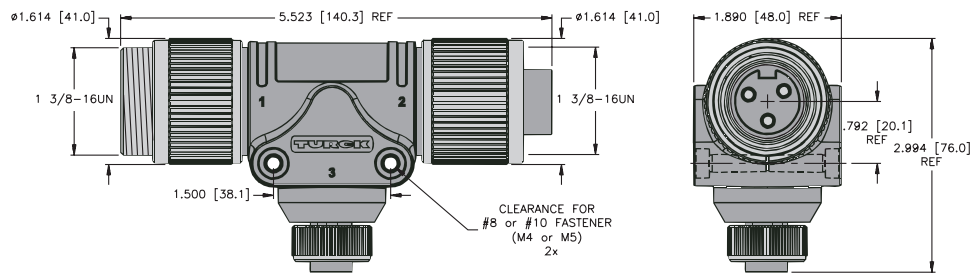

15

**Integral M16 Power Connector Drop  
GSDM/GKDM/BKM..**

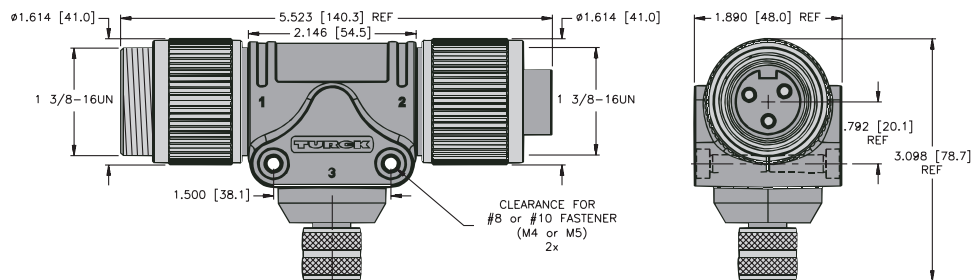

D-Size 1 3/8" powerfast

### Tee with Cable Drop and Connector Options

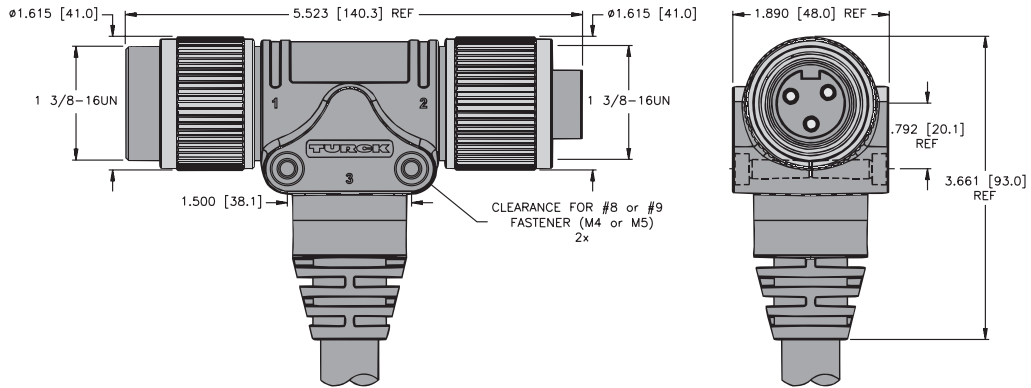

**16 Cable Drop**  
GSDM/GKDM/T..

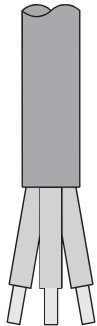

**17 D-Size Power Connector**  
GSDM/2GKDM..

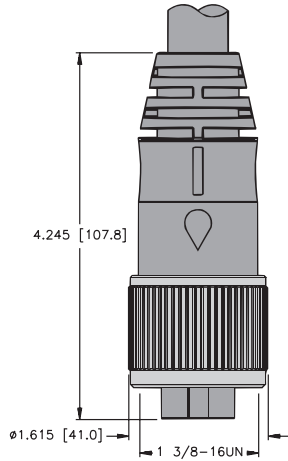

**18 A-Size Power Connector**  
GSDM/GKDM/RKM..

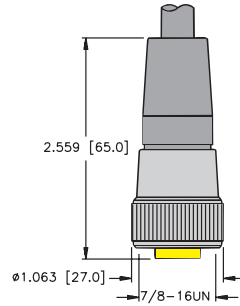

**19 M16 Power Connector**  
GSDM/GKDM/BKM..

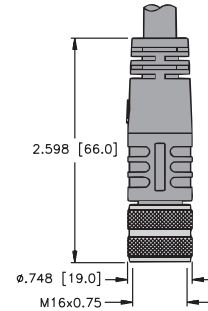



**D-Size 1 3/8" Powerfast h-Style Tee Dimensions**

20

**Integral D-Size Power Connector Drop  
SH-GSDM/2GKDM..**

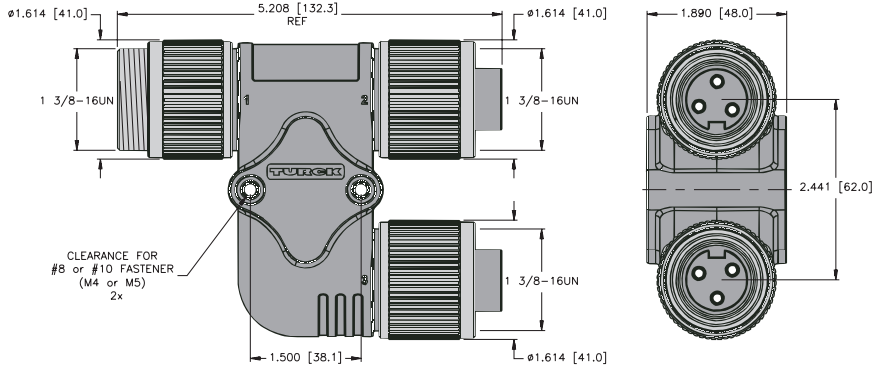

21

**Integral A-Size Power Connector Drop  
SH-GSDM/GKDM/RKM..**

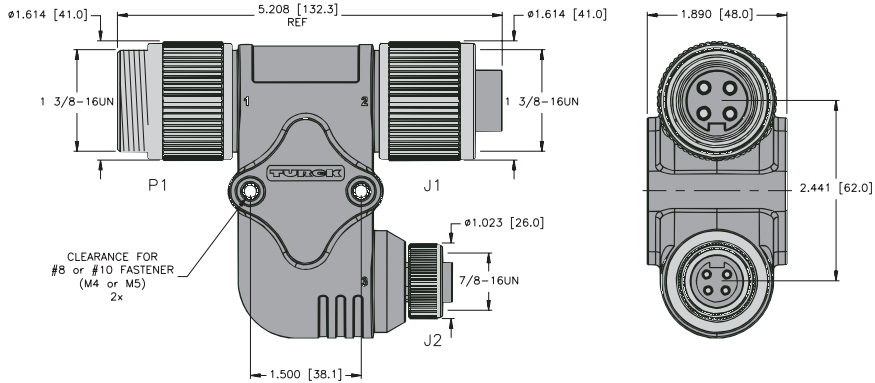

22

**Integral M16 Power Connector Drop  
SH-GSDM/GKDM/BKM..**

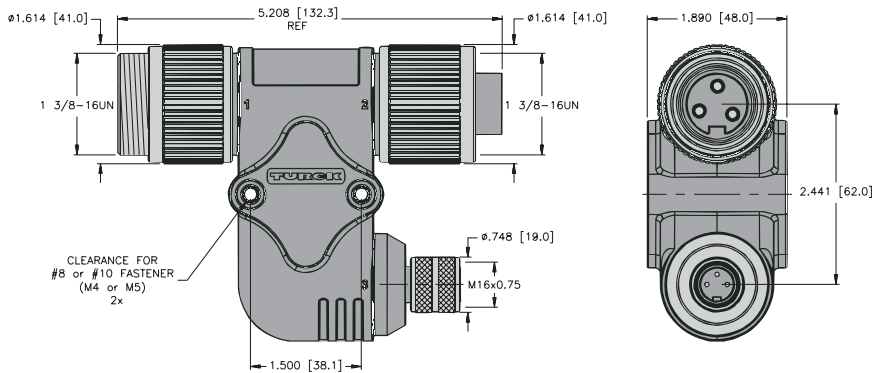

D-Size 1 3/8" powerfast

**h-Style Tee with Cable Drop and Connector Options**

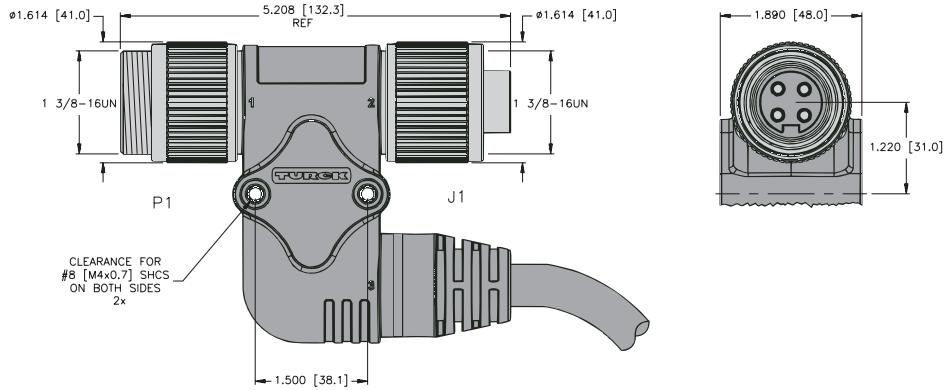

**23 Cable Drop**  
SH-GSDM/GKDM/T

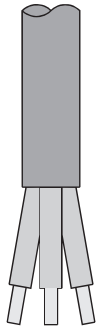

**24 D-Size Power Connector**  
SH-GSDM/2GKDM..

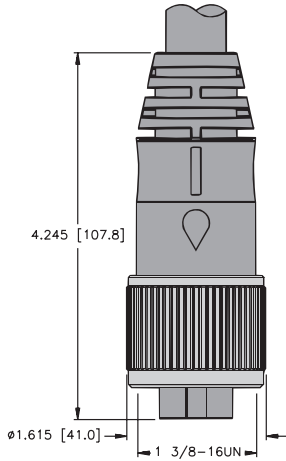

**25 A-Size Power Connector**  
SH-GSDM/GKDM/RKM..

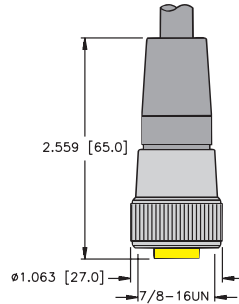

**26 M16 Power Connector**  
SH-GSDM/GKDM/BKM..

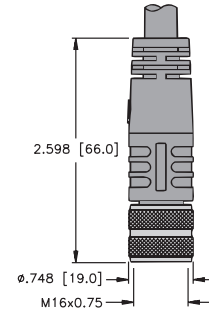

**D-Size 1 3/8" Powerfast Power Reducer Specifications**

**Mechanical**

|                                  |   |
|----------------------------------|---|
| <b>Mold material/color:</b>      | PVC/Black                                     |
| <b>Contact carrier material:</b> | PVC   |
| <b>Coupling nut material:</b>    |   |
| Standard:                        | Nickel plated brass                           |
| Additional options:              | Anodized aluminum<br>316 stainless steel      |
| <b>Environmental protection:</b> | NEMA 1, 3, 4, 6P and<br>IEC IP67, IP68, IP69K |
| <b>Temperature rating:</b>       | -40 °C to +90 °C (-40 °F to +194 °F)          |

**Electrical**

|                          |                                   |
|--------------------------|-----------------------------------|
| <b>Contact material:</b> | Brass or copper with gold plating |
| <b>Ratings:</b>          | 15 Amps, 600 VAC                  |



Note: UL approval applies to D-size and A-size Power connectors.

**D-Size 1 3/8" Powerfast Power Reducer Selection Matrix**

|             |                 |                       |   |  |  |  |
|-------------|-----------------|-----------------------|---|--|--|--|
|             |                 |                       | 27  |  | 28                                       |  |
| <b>Pins</b> | <b>Drop AWG</b> | <b>Current Rating</b> | <b>D-Size Power to A-Size Power Reducer</b> |  | <b>D-Size Power to M16 Power Reducer</b> |  |
| 3           | 14              | Up to 15 Amps         | GSDM RKM 34-0                               |  | GSDM BKM 34-0                            |  |
| 4           | 14              | Up to 15 Amps         | GSDM RKM 44-0                               |  | GSDM BKM 44-0                            |  |

See below for dimensional drawings.

Note: Standard coupling nut material is nickel plated brass. Consult factory for anodized aluminum and 316 stainless steel options.

**D-Size 1 3/8" Powerfast Power Reducer Dimensions**

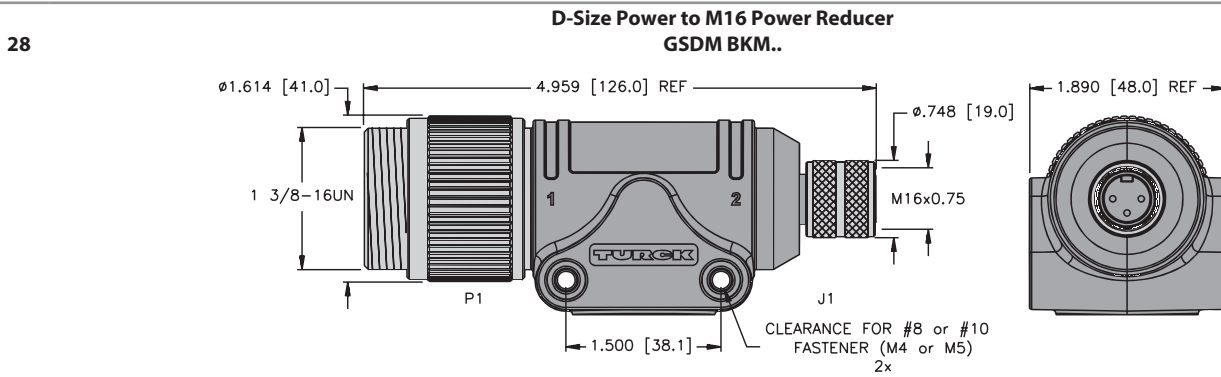
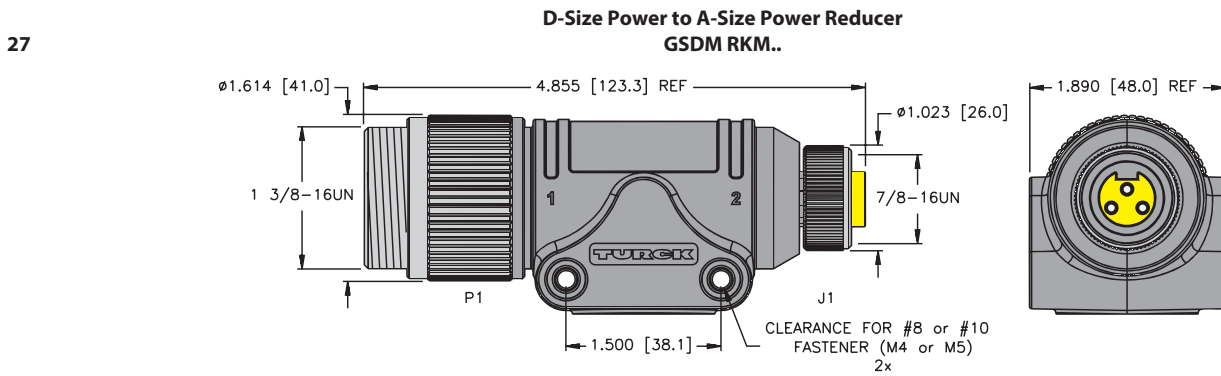

We reserve the right to make technical alterations without prior notice.

D-Size 1 3/8" powerfast

# D-Size 1 3/8" powerfast Connectivity



## D-Size 1 3/8" Powerfast Tee Wiring Diagrams

Cable Drop

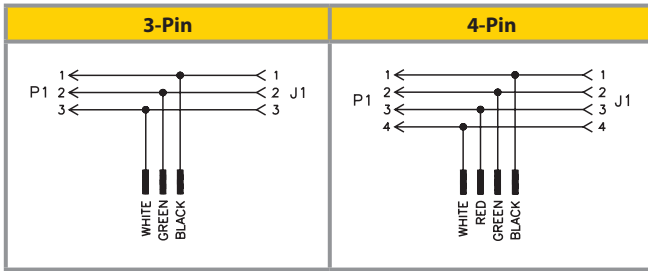

D-Size Power Drop

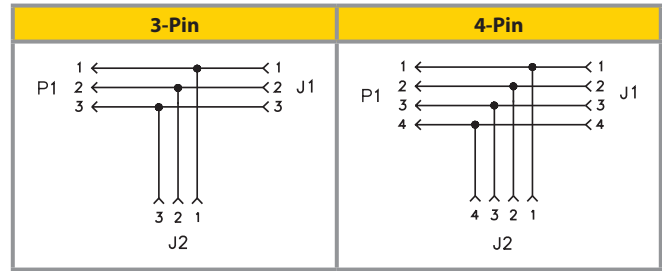

A-Size Power Drop

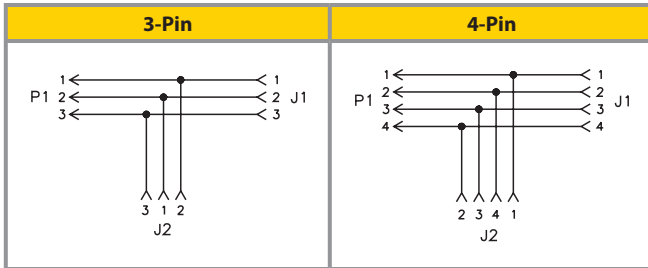

M16 Power Drop

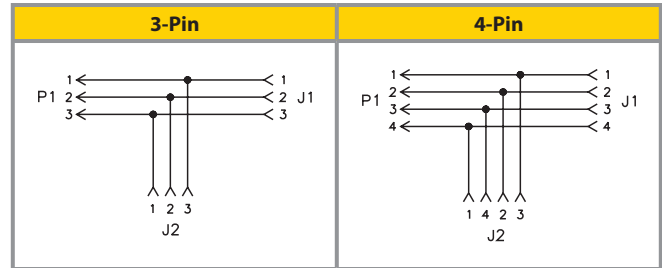

## D-Size 1 3/8" Powerfast Power Reducer Wiring Diagrams

D-Size Power to A-Size Power

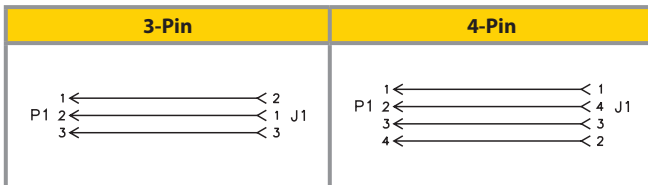

D-Size Power to M16 Power

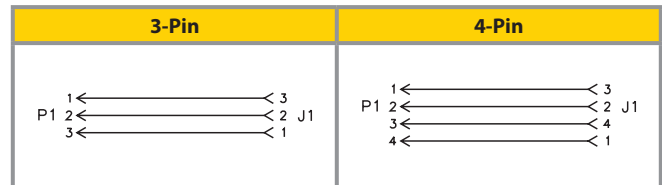

## D-Size 1 3/8" Powerfast Tee and Power Reducer Pinouts

### D-Size Power

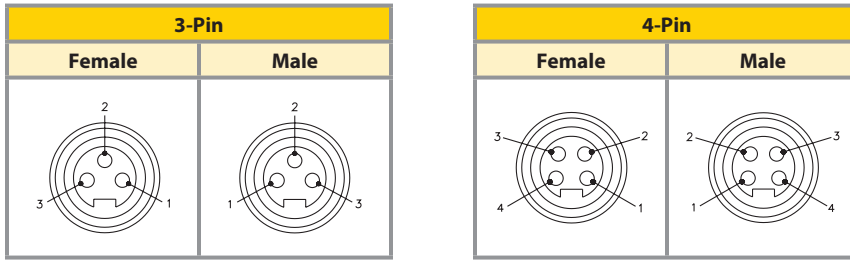

### A-Size Power

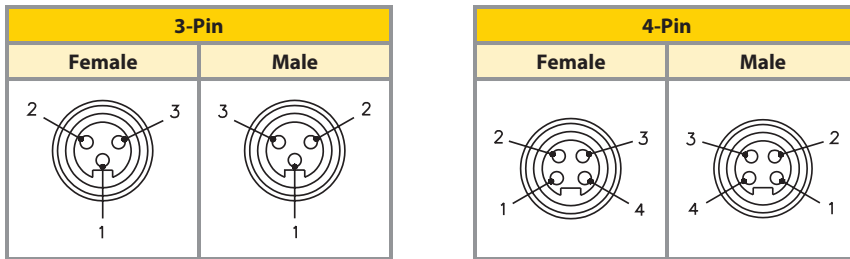

### M16 Power

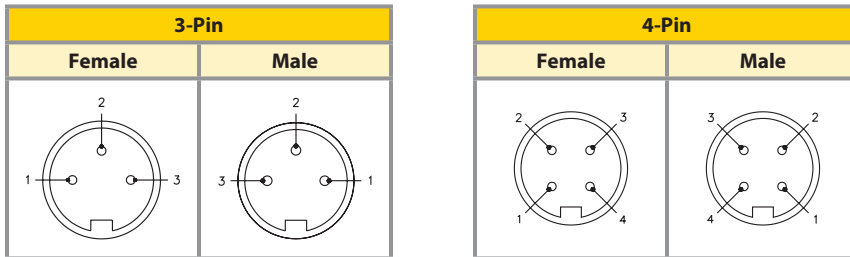

# D-Size 1 3/8" powerfast Connectivity



## D-Size 1 3/8" Powerfast Closure Cap Selection Matrix

|                     |             | 29                                     | 30                                       | 31                        | 32                          | 33                                     | 34                                       |
|---------------------|-------------|--|--|---------------------------|-----------------------------|--|--|
|                     |             | Mates to male cordsets and receptacles | Mates to female cordsets and receptacles | Mates to male receptacles | Mates to female receptacles | Mates to male cordsets and receptacles | Mates to female cordsets and receptacles |
| Material            | Thread      | 6" SS Loop Lanyard                     | 6" SS Loop Lanyard                       | 6" SS Lanyard with Eyelet | 6" SS Lanyard with Eyelet   | No Lanyard                             | No Lanyard                               |
| Nickel Plated Brass | 1 3/8-16 UN | GKDM-CC                                | GSDM-CC                                  | GKDF-CC                   | GSDF-CC                     | GKDM-MC                                | GSDM-MC                                  |

See table below for dimensional drawings.

## D-Size 1 3/8" Powerfast Power Reducer Wiring Diagrams

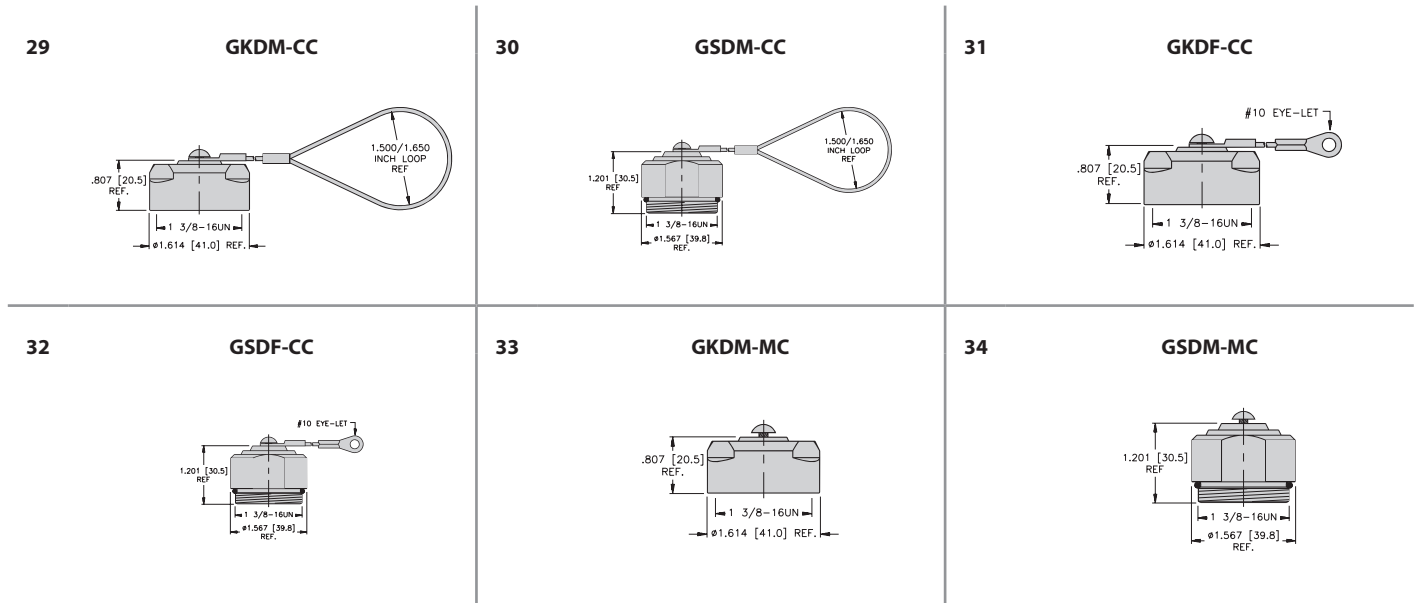

## D-Size 1 3/8" Powerlok

| Part Number         | Application   |
|---------------------|---|
| <b>LOCK-A POWER</b> | Nylon locking guard for straight or right angle D-Size Powerfast connectors |

A-Size Powerlok Open



A-Size Powerlok Closed



|  |            |
|--|------------|
| <b>Part Number Keys</b>  | <b>J28</b> |
| <b>Cordset, Receptacle and Field Wireable Specifications</b>   | <b>J30</b> |
| <b>Cordset, Receptacle and Field Wireable Selection Matrix</b> | <b>J31</b> |
| <b>Cordset, Receptacle and Field Wireable Dimensions</b>       | <b>J32</b> |
| <b>Cordset, Receptacle and Field Wireable Pinouts</b>          | <b>J33</b> |
| <b>Tee Specifications</b>                                      | <b>J34</b> |
| <b>Tee Selection Matrix</b>                                    | <b>J34</b> |
| <b>Tee Dimensions</b>  | <b>J35</b> |
| <b>Tee Wiring Diagrams</b>                                     | <b>J41</b> |
| <b>Tee Pinouts</b>   | <b>J41</b> |
| <b>Closure Caps</b>  | <b>J42</b> |
| <b>Powerlok Accessories</b>                                    | <b>J42</b> |

## Features

- Ideal for small motor applications
- Shielded versions available
- Multiple tee configurations
- 2 to 4-pin
- 12 and 14 AWG conductors
- Up to 18 Amp, 600 Volt rated
- Tray rated-exposed run PVC cable
- IEC IP67 protection



## M16 Powerfast Cordset Part Number Key

Part Number Keys are to assist in IDENTIFICATION ONLY. Consult factory for catalog items not identified.

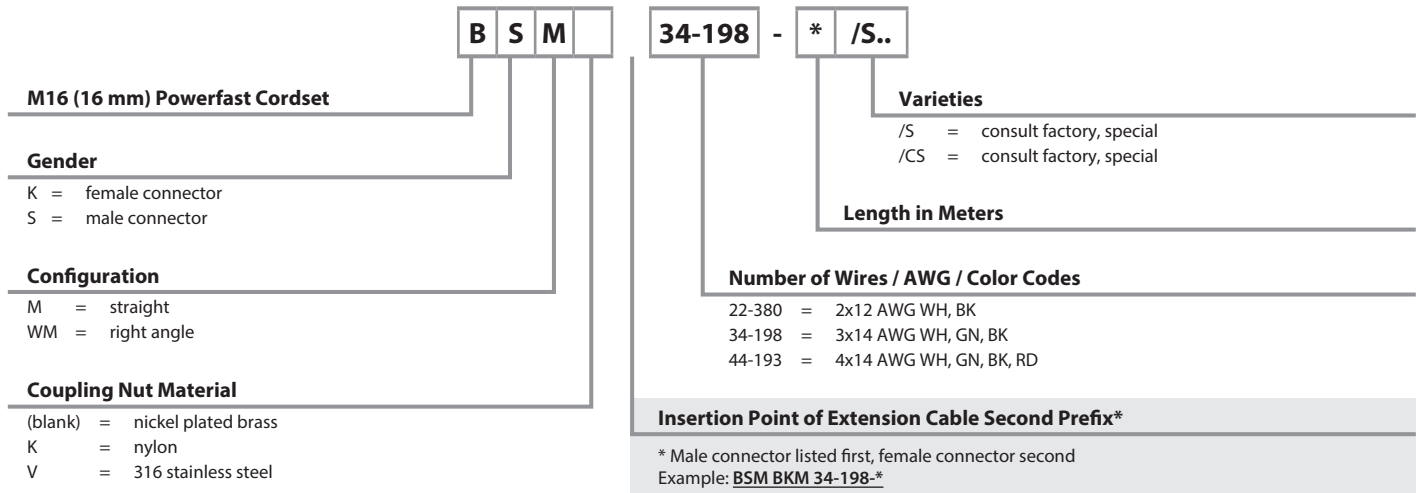

### Extension Examples



## M16 Powerfast Tee Part Number Key

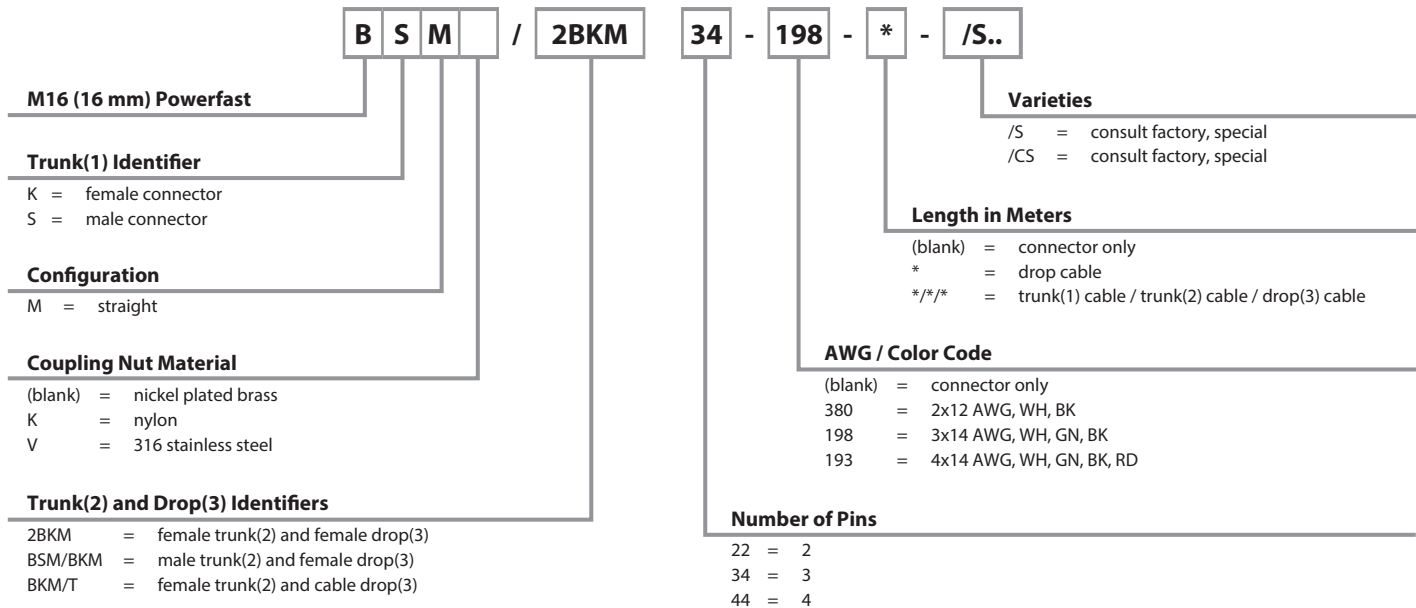

Note: Only one male connector per tee available.

### Extension Examples

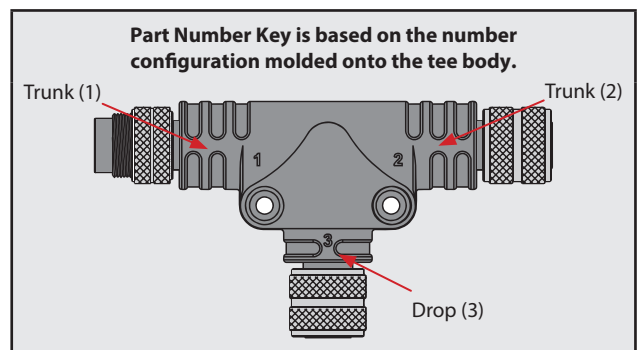



## M16 Powerfast Receptacle Part Number Key

Part Number Keys are to assist in IDENTIFICATION ONLY. Consult factory for catalog items not identified.

|          |          |          |  |  |           |   |   |                  |
|----------|----------|----------|--|--|-----------|---|---|------------------|
| <b>B</b> | <b>K</b> | <b>F</b> |  |  | <b>22</b> | - | * | <b>/14.5/NPT</b> |
|----------|----------|----------|--|--|-----------|---|---|------------------|

**M16 (16 mm) Powerfast Receptacle**

**Gender**  
K = female receptacle  
S = male receptacle

**Designator for Receptacle**

**Housing Style**  
(blank) = front mount  
D = rear mount

**Housing Material**  
(blank) = nickel plated brass  
V = 316 stainless steel

**Thread Type**  
/14.5/NPT = 1/2-14 NPT threads  
/18.375/NPT = 3/8-18 NPT threads  
/M20 = M20 threads  
/M18 = M18 threads

**Length in Meters**

**Number of Wires / AWG / Color Codes**  
22 = 2x12 AWG WH, BK  
34 = 3x14 AWG WH, GN, BK  
44 = 4x14 AWG WH, GN, BK, RD

## M16 Powerfast Tee Part Number Key

|           |   |          |          |          |  |             |  |           |   |            |   |   |   |             |
|-----------|---|----------|----------|----------|--|-------------|--|-----------|---|------------|---|---|---|-------------|
| <b>BH</b> | - | <b>B</b> | <b>S</b> | <b>M</b> |  | <b>2BKM</b> |  | <b>34</b> | - | <b>198</b> | - | * | - | <b>/S..</b> |
|-----------|---|----------|----------|----------|--|-------------|--|-----------|---|------------|---|---|---|-------------|

**M16 (16 mm) Powerfast**  
BH = big H  
SH = small h

**M16 (16 mm) Powerfast**

**Trunk(1) Identifier**  
K = female connector  
S = male connector

**Configuration**  
M = straight

**Coupling Nut Material**  
(blank) = nickel plated brass  
K = nylon  
V = 316 stainless steel

**Trunk(2) and Drop(3) Identifiers**  
2BKM = female trunk(2) and female drop(3)  
BSM/BKM = male trunk(2) and female drop(3)  
BKM/T = female trunk(2) and cable drop(3)  
BSM/BKM = male trunk(2) and female drop(3)  
BKM/T = female trunk(2) and cable drop(3)

**Varieties**  
/S = consult factory, special  
/CS = consult factory, special

**Length in Meters**  
(blank) = connector only  
\* = drop cable  
\*\*/\* = trunk(1) cable / trunk(2) cable / drop(3) cable  
\*\*/\*/\* = trunk(1) cable / trunk(2) cable / drop(3) cable / drop(4) cable

**AWG / Color Code**  
(blank) = connector only  
380 = 2x12 AWG, WH, BK  
198 = 3x14 AWG, WH, GN, BK  
193 = 4x14 AWG, WH, GN, BK, RD

**Number of Pins**  
22 = 2  
34 = 3  
44 = 4

M16 powerfast

### Extension Examples

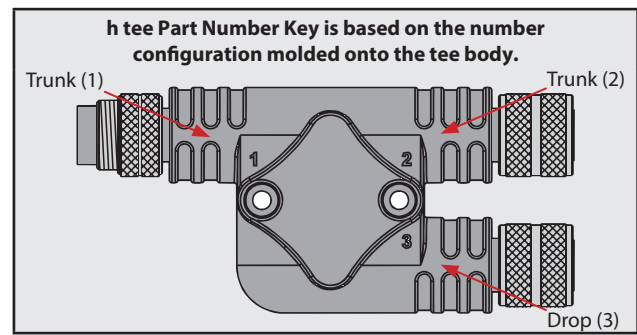
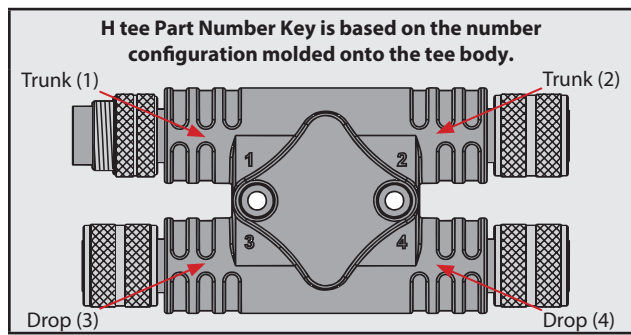
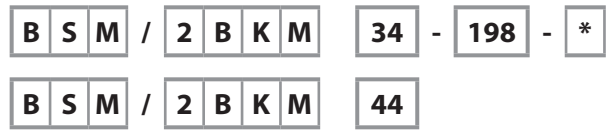

## M16 Powerfast Cordset Specifications

### Mechanical

|                                  |                                      |
|----------------------------------|--------------------------------------|
| <b>Mold material/color:</b>      | PUR/Black                            |
| <b>Contact carrier material:</b> | PUR                                  |
| <b>Coupling nut material:</b>    |                                      |
| Standard:                        | Nickel plated brass                  |
| Additional options:              | Nylon<br>316 stainless steel         |
| <b>Environmental protection:</b> | IEC IP67                             |
| <b>Temperature rating:</b>       | -40 °C to +90 °C (-40 °F to +194 °F) |

### Electrical

|                                     |                                   |
|-------------------------------------|-----------------------------------|
| <b>Contact material:</b>            | Brass or copper with gold plating |
| <b>Cable jacket material/color:</b> | TC-ER PVC/Black                   |
| <b>Ratings:</b>                     | 15-18 Amps, 600 V                 |



## M16 Powerfast Receptacle Specifications

### Mechanical

|                                  |                                       |
|----------------------------------|---------------------------------------|
| <b>Contact carrier material:</b> | PUR                                   |
| <b>Housing material/plating:</b> |                                       |
| Standard:                        | Nickel plated brass                   |
| Additional options:              | 316 stainless steel                   |
| <b>O-Ring material:</b>          | Nitrile (BUNA-N)                      |
| <b>Environmental protection:</b> | IEC IP67                              |
| <b>Temperature rating:</b>       | -40 °C to +105 °C (-40 °F to +221 °F) |

### Electrical

|                              |                                   |
|------------------------------|-----------------------------------|
| <b>Contact material:</b>     | Brass or copper with gold plating |
| <b>Conductor insulation:</b> | PVC                               |
| <b>Ratings:</b>              | 15-18 Amps, 600 V                 |



## M16 Powerfast Field Wireable Specifications





### Mechanical

|                                  |                                      |
|----------------------------------|--------------------------------------|
| <b>Housing material/color:</b>   | Glass filled nylon or PVC/Black      |
| <b>Contact carrier material:</b> | PUR                                  |
| <b>Coupling nut material:</b>    |                                      |
| Standard:                        | Nickel plated brass                  |
| Additional options:              | Nylon<br>316 stainless steel         |
| <b>Environmental protection:</b> | NEMA 6P and IEC IP67                 |
| <b>Temperature rating:</b>       | -40 °C to +90 °C (-40 °F to +194 °F) |

### Electrical

|                          |                                   |
|--------------------------|-----------------------------------|
| <b>Contact material:</b> | Brass or copper with gold plating |
| <b>Ratings:</b>          | 15-18 Amps, 600 VAC               |

## M16 Powerfast Cordset Selection Matrix

|      |     |                | 1  | 2  | 3  | 4  |
|------|-----|----------------|---|---|---|---|
|      |     |                | Straight Female   | Straight Male   | Right Angle Female  | Right Angle Male  |
| Pins | AWG | Current Rating | TC-ER   | TC-ER   | TC-ER   | TC-ER   |
| 2    | 12  | 18 Amps        | BKM 22-380-*  | BSM 22-380-*  | BKWM 22-380-*   | BSWM 22-380-*   |
| 3    | 14  | 15 Amps        | BKM 34-198-*  | BSM 34-198-*  | BKWM 34-198-*   | BSWM 34-198-*   |
| 4    | 14  | 15 Amps        | BKM 44-193-*  | BSM 44-193-*  | BKWM 44-193-*   | BSWM 44-193-*   |

| Pins | AWG | Current Rating | SHIELDED TC-ER | SHIELDED TC-ER | SHIELDED TC-ER  | SHIELDED TC-ER  |
|------|-----|----------------|----------------|----------------|-----------------|-----------------|
| 2    | 12  | 18 Amps        | BKMS 22-1759-* | BSMS 22-1759-* | BKWMS 22-1759-* | BSWMS 22-1759-* |
| 3    | 14  | 15 Amps        | BKMS 34-1364-* | BSMS 34-1364-* | BKWMS 34-1364-* | BSWMS 34-1364-* |
| 4    | 14  | 15 Amps        | BKMS 44-1363-* | BSMS 44-1363-* | BKWMS 44-1363-* | BSWMS 44-1363-* |

We reserve the right to make technical alterations without prior notice.

2 and 3-Wire Receptacles, Front Mount, 1/4-18 NPT Threads

| Front Mount |     |                | 5                          |  | 6                          |  | 7                          |  | 8                          |  |
|-------------|-----|----------------|----------------------------|--|----------------------------|--|----------------------------|--|----------------------------|--|
|             |     |                | Female                     |  | Male                       |  | Female                     |  | Male                       |  |
| Pins        | AWG | Current Rating | 1/2-14 NPT Mounting Thread |  | 1/2-14 NPT Mounting Thread |  | 3/8-18 NPT Mounting Thread |  | 3/8-18 NPT Mounting Thread |  |
| 2           | 12  | 18 Amps        | BKF 22-*/14.5/NPT          |  | BSF 22-*/14.5/NPT          |  | BKF 22-*/18.375/NPT        |  | BSF 22-*/18.375/NPT        |  |
| 3           | 14  | 15 Amps        | BKF 34-*/14.5/NPT          |  | BSF 34-*/14.5/NPT          |  | BKF 34-*/18.375/NPT        |  | BSF 34-*/18.375/NPT        |  |
| 4           | 14  | 15 Amps        | BKF 44-*/14.5/NPT          |  | BSF 44-*/14.5/NPT          |  | BKF 44-*/18.375/NPT        |  | BSF 44-*/18.375/NPT        |  |

| Front Mount |     |                | 9                   |  | 10                  |  | 11                  |  | 12                  |  |
|-------------|-----|----------------|---------------------|--|---------------------|--|---------------------|--|---------------------|--|
|             |     |                | Female              |  | Male                |  | Female              |  | Male                |  |
| Pins        | AWG | Current Rating | M18 Mounting Thread |  | M18 Mounting Thread |  | M20 Mounting Thread |  | M20 Mounting Thread |  |
| 2           | 12  | 18 Amps        | BKF 22-*/M18        |  | BSF 22-*/M18        |  | BKF 22-*/M20        |  | BSF 22-*/M20        |  |
| 3           | 14  | 15 Amps        | BKF 34-*/M18        |  | BSF 34-*/M18        |  | BKF 34-*/M20        |  | BSF 34-*/M20        |  |
| 4           | 14  | 15 Amps        | BKF 44-*/M18        |  | BSF 44-*/M18        |  | BKF 44-*/M20        |  | BSF 44-*/M20        |  |

| Front Mount |     |                | 13                  |  | 14                  |  |
|-------------|-----|----------------|---------------------|--|---------------------|--|
|             |     |                | Female              |  | Male                |  |
| Pins        | AWG | Current Rating | M18 Mounting Thread |  | M18 Mounting Thread |  |
| 2           | 12  | 18 Amps        | BKFD 22-*/M18       |  | BSFD 22-*/M18       |  |
| 3           | 14  | 15 Amps        | BKFD 34-*/M18       |  | BSFD 34-*/M18       |  |
| 4           | 14  | 15 Amps        | BKFD 44-*/M18       |  | BSFD 44-*/M18       |  |

See pages 32-33 for dimensional drawings.

\* Length in meters. Standard lead length is 0.5 meters. Consult factory for other lengths.

Note: Standard housing material is nickel plated brass. Consult Part Number Key (page 27) for 316 stainless steel options.

We reserve the right to make technical alterations without prior notice.

M16 powerfast

M16 Powerfast Field Wireable Selection Matrix

|      |                          |                | 15   |  | 16   |  |
|------|--------------------------|----------------|--|--|--|--|
|      |                          |                | Straight Female, PG 11 Cable Gland<br>Accepts 8-11 mm Cable Diameter |  | Straight Male, PG 11 Cable Gland<br>Accepts 8-11 mm Cable Diameter |  |
| Pins | Acceptable Conductor AWG | Current Rating | Screw Terminal   |  | Screw Terminal   |  |
| 2    | 12                       | 18 Amps        | BK 22-0  |  | BS 22-0  |  |
| 3    | 14                       | 15 Amps        | BK 34-0  |  | BS 34-0  |  |
| 4    | 14                       | 15 Amps        | BK 44-0  |  | BS 44-0  |  |

See page 33 for dimensional drawings.

\* Note: Standard coupling nut material is nickel plated brass. Consult factory for nylon and 316 stainless steel options.

|   |   |
|---|---|
| <p><b>1</b> <b>BKM..</b></p>            | <p><b>2</b> <b>BSM..</b></p>            |
| <p><b>3</b> <b>BKWM..</b></p>           | <p><b>4</b> <b>BSWM..</b></p>           |
| <p><b>5</b> <b>BKF../14.5/NPT</b></p>   | <p><b>6</b> <b>BSF../14.5/NPT</b></p>   |
| <p><b>7</b> <b>BKF../18.375/NPT</b></p> | <p><b>8</b> <b>BSF../18.375/NPT</b></p> |
| <p><b>9</b> <b>BKF../M18</b></p>        | <p><b>10</b> <b>BSF../M18</b></p>       |
| <p><b>11</b> <b>BKF../M20</b></p>       | <p><b>12</b> <b>BSF../M20</b></p>       |

M16 Powerfast Cordset, Receptacle and Field Wireable Dimensions

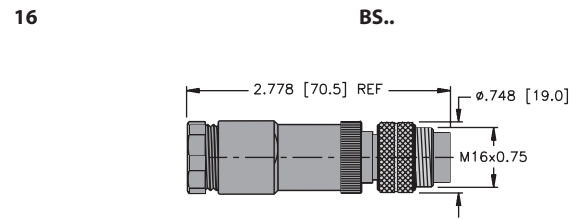
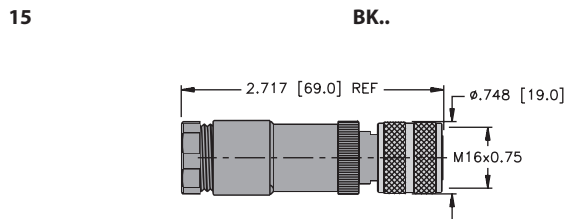
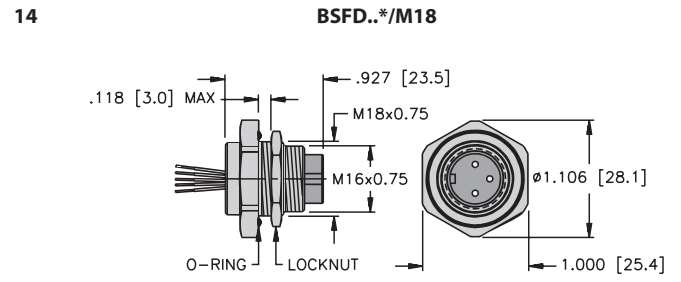
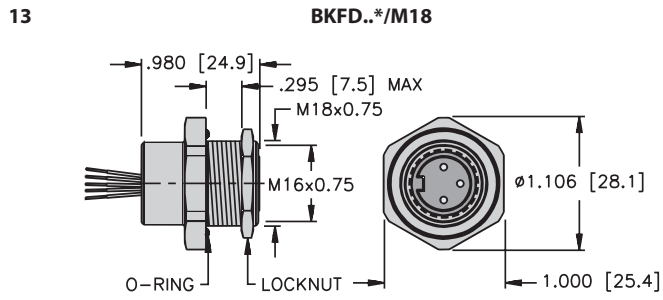

M16 Powerfast Cordset, Receptacle and Field Wireable Pinouts

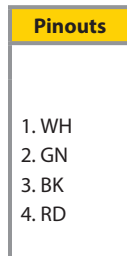
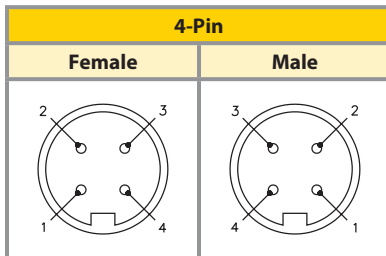
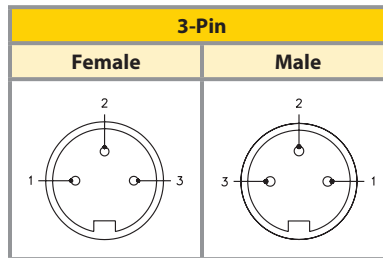
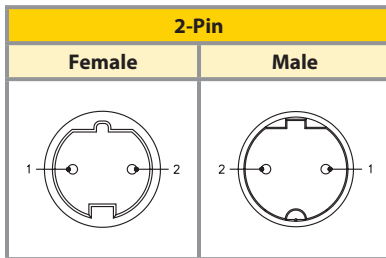

## M16 Powerfast Tee Specifications

### Mechanical

|                                  |                              |
|----------------------------------|------------------------------|
| <b>Mold material/color:</b>      | PUR/Black                    |
| <b>Contact carrier material:</b> | PUR                          |
| <b>Housing material/plating:</b> |                              |
| Standard:                        | Nickel plated brass          |
| Additional options:              | Nylon<br>316 stainless steel |
| <b>Environmental protection:</b> | IEC IP67                     |

### Electrical

|                                     |                                   |
|-------------------------------------|-----------------------------------|
| <b>Contact material:</b>            | Brass or copper with gold plating |
| <b>Cable jacket material/color:</b> | TC-ER PVC/Black                   |
| <b>Ratings:</b>                     | 15-18 Amps, 600 V                 |



### Temperature rating:

|                             |                                       |
|-----------------------------|---------------------------------------|
| Integral connector version: | -40 °C to +105 °C (-40 °F to +221 °F) |
| Cable version:              | -40 °C to +90 °C (-40 °F to +194 °F)  |

## M16 Powerfast Tee Selection Matrix

|      |     |                | 17                                | 18                                  | 19   | 20                |
|------|-----|----------------|-----------------------------------|-------------------------------------|--|-------------------|
|      |     |                |                                   |                                     |  |                   |
|      |     |                | Integral M16 Power Connector Drop | Cable Drop with M16 Power Connector | Cable Trunk and Cable Drop with M16 Power Connectors | Cable Drop        |
| Pins | AWG | Current Rating | TC-ER                             |                                     | TC-ER  |                   |
| 2    | 12  | 18 Amps        | BSM/2BKM 22                       | BSM/2BKM 22-380-*                   | BSM/2BKM 22-380-*/*/*                                | BSM/BKM/T22-380-* |
| 3    | 14  | 15 Amps        | BSM/2BKM 34                       | BSM/2BKM 34-198-*                   | BSM/2BKM 34-198-*/*/*                                | BSM/BKM/T34-198-* |
| 4    | 14  | 15 Amps        | BSM/2BKM 44                       | BSM/2BKM 44-193-*                   | BSM/2BKM 44-193-*/*/*                                | BSM/BKM/T44-193-* |

We reserve the right to make technical alterations without prior notice.

## M16 Powerfast h-Style Tee Selection Matrix

|      |     |                | 21                                | 22                                  | 23   | 24                   |
|------|-----|----------------|-----------------------------------|-------------------------------------|--|----------------------|
|      |     |                |                                   |                                     |  |                      |
|      |     |                | Integral M16 Power Connector Drop | Cable Drop with M16 Power Connector | Cable Trunk and Cable Drop with M16 Power Connectors | Cable Drop           |
| Pins | AWG | Current Rating | TC-ER                             |                                     | TC-ER  |                      |
| 2    | 12  | 18 Amps        | SH-BSM/2BKM 22                    | SH-BSM/2BKM 22-380-*                | SH-BSM/2BKM 22-380-*/*/*                             | SH-BSM/BKM/T22-380-* |
| 3    | 14  | 15 Amps        | SH-BSM/2BKM 34                    | SH-BSM/2BKM 34-198-*                | SH-BSM/2BKM 34-198-*/*/*                             | SH-BSM/BKM/T34-198-* |
| 4    | 14  | 15 Amps        | SH-BSM/2BKM 44                    | SH-BSM/2BKM 44-193-*                | SH-BSM/2BKM 44-193-*/*/*                             | SH-BSM/BKM/T44-193-* |

|      |     |                | 25                                | 26                                  | 27   | 28                   |
|------|-----|----------------|-----------------------------------|-------------------------------------|--|----------------------|
|      |     |                |                                   |                                     |  |                      |
|      |     |                | Integral M16 Power Connector Drop | Cable Drop with M16 Power Connector | Cable Trunk and Cable Drop with M16 Power Connectors | Cable Drop           |
| Pins | AWG | Current Rating | TC-ER                             |                                     | TC-ER  |                      |
| 2    | 12  | 18 Amps        | SH-BKM/BSM/BKM 22                 | SH-BKM/BSM/BKM 22-380-*             | SH-BKM/BSM/BKM 22-380-*/*/*                          | SH-BKM/BSM/T22-380-* |
| 3    | 14  | 15 Amps        | SH-BKM/BSM/BKM 34                 | SH-BKM/BSM/BKM 34-198-*             | SH-BKM/BSM/BKM 34-198-*/*/*                          | SH-BKM/BSM/T34-198-* |
| 4    | 14  | 15 Amps        | SH-BKM/BSM/BKM 44                 | SH-BKM/BSM/BKM 44-193-*             | SH-BKM/BSM/BKM 44-193-*/*/*                          | SH-BKM/BSM/T44-193-* |

## 2 and 3-Wire Receptacles, Front Mount, 1/4-18 NPT Threads

|                                 |            |                       | 29                                       | 30   | 31  |
|---------------------------------|------------|-----------------------|--|--|---|
|                                 |            |                       |  |  |   |
| <b>Trunk #1: Male Connector</b> |            |                       | <b>Integral M16 Power Connector Drop</b> | <b>Cable Drop with M16 Power Connector</b> | <b>Cable Trunk and Cable Drop with M16 Power Connectors</b> |
| <b>Pins</b>                     | <b>AWG</b> | <b>Current Rating</b> | <b>TC-ER</b>                             |  | <b>TC-ER</b>  |
| 2                               | 12         | 18 Amps               | BH-BSM/3BKM 22                           | BH-BSM/3BKM 22-380-*                       | BH-BSM/3BKM 22-380-*/*/**                                   |
| 3                               | 14         | 15 Amps               | BH-BSM/3BKM 34                           | BH-BSM/3BKM 34-198-*                       | BH-BSM/3BKM 34-198-*/*/**                                   |
| 4                               | 14         | 15 Amps               | BH-BSM/3BKM 44                           | BH-BSM/3BKM 44-193-*                       | BH-BSM/3BKM 44-193-*/*/**                                   |

|                                 |            |                       | 32                                       | 33   | 34  |
|---------------------------------|------------|-----------------------|--|--|---|
|                                 |            |                       |  |  |   |
| <b>Trunk #1: Male Connector</b> |            |                       | <b>Integral M16 Power Connector Drop</b> | <b>Cable Drop with M16 Power Connector</b> | <b>Cable Trunk and Cable Drop with M16 Power Connectors</b> |
| <b>Pins</b>                     | <b>AWG</b> | <b>Current Rating</b> | <b>TC-ER</b>                             |  | <b>TC-ER</b>  |
| 2                               | 12         | 18 Amps               | BH-BKM/BSM/2BKM 22                       | BH-BKM/BSM/2BKM 22-380-*                   | BH-BKM/BSM/2BKM 22-380-*/*/**                               |
| 3                               | 14         | 15 Amps               | BH-BKM/BSM/2BKM 34                       | BH-BKM/BSM/2BKM 34-198-*                   | BH-BKM/BSM/2BKM 34-198-*/*/**                               |
| 4                               | 14         | 15 Amps               | BH-BKM/BSM/2BKM 44                       | BH-BKM/BSM/2BKM 44-193-*                   | BH-BKM/BSM/2BKM 44-193-*/*/**                               |

See pages 35-40 for dimensional drawings.

\* Length in meters. Standard cable lengths are 2, 5 and 10 meters. Consult factory for other lengths.

Note: Standard coupling nut material is nickel plated brass. Consult Part Number Key (page 27) for nylon and 316 stainless steel options.

We reserve the right to make technical alterations without prior notice.

M16 powerfast

## M16 Powerfast Tee Dimensions

**Integral M16 Power Connector Drop  
BSM/2BKM..**

17

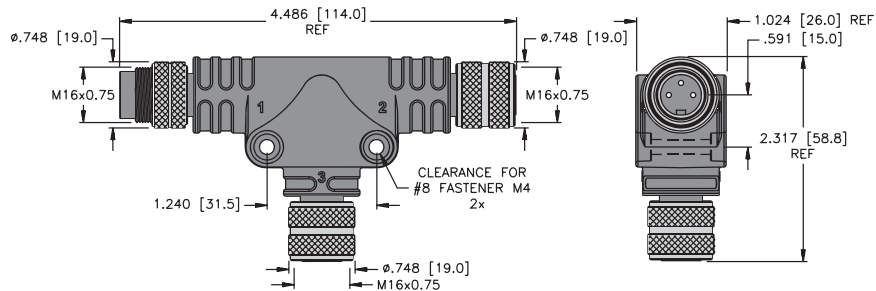

M16 Powerfast Tee Dimensions

18

Cable Drop with M16 Power Connector  
BSM/2BKM..

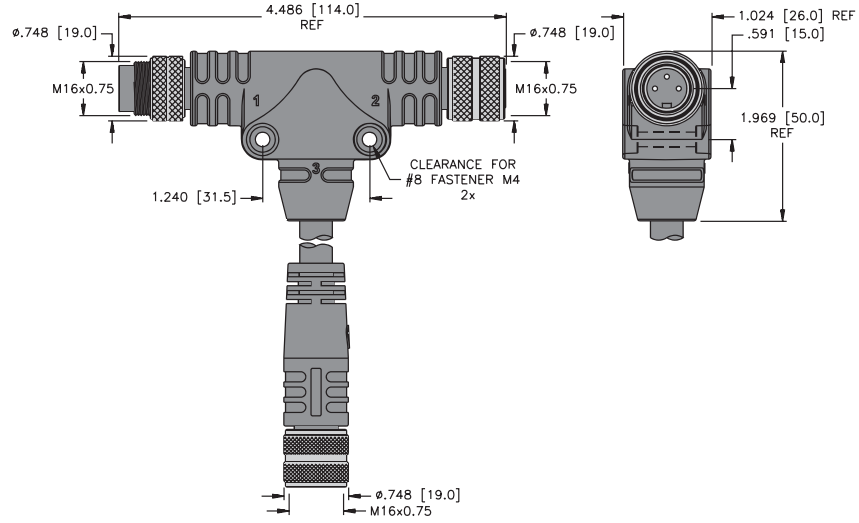

19

Cable Trunk and Cable Drop with M16 Power Connectors  
BSM/2BKM..

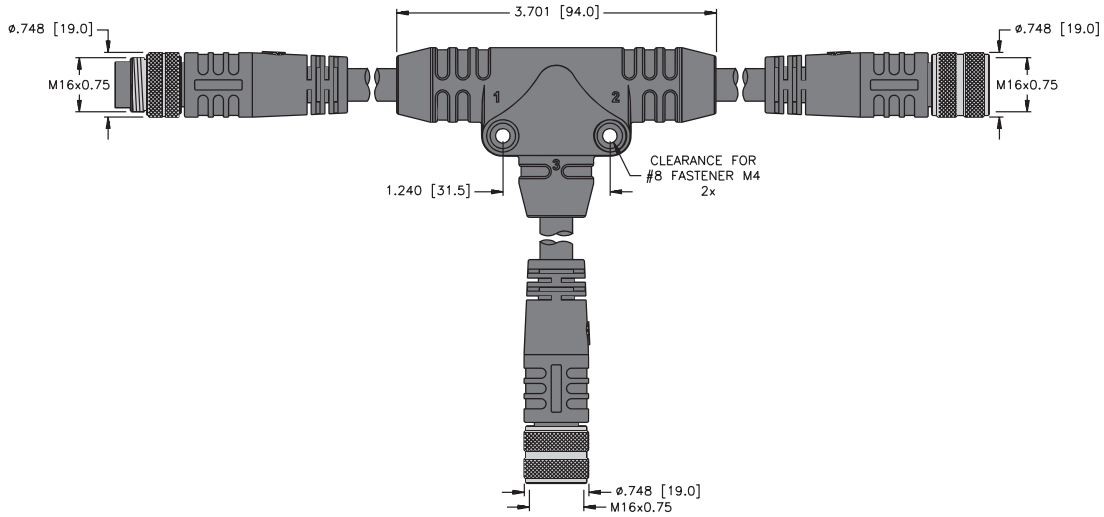

20

Cable Drop  
BSM/BKM/T..

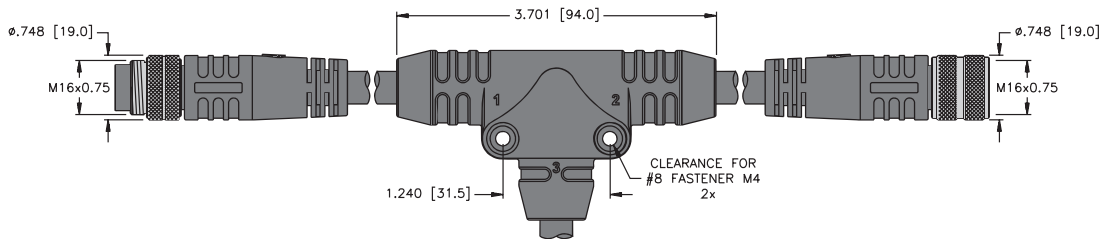



M16 Powerfast h-Style Tee Dimensions

21

Integral M16 Power Connector Drop, Trunk #1 Male  
SH-BSM/2BKM..

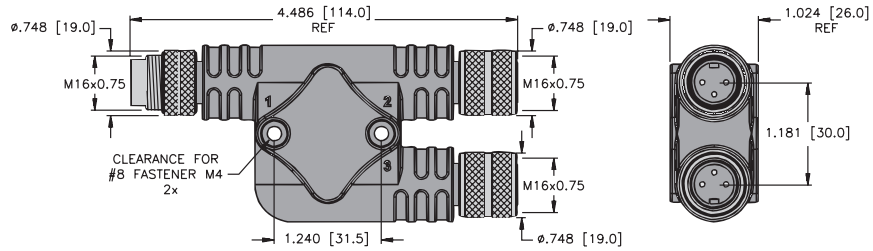

22

Cable Drop with M16 Power Connector, Trunk #1 Male  
SH-BSM/2BKM..

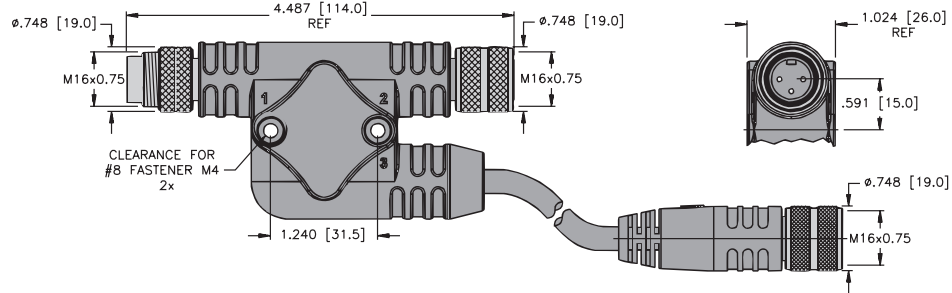

23

Cable Trunk and Cable Drop with M16 Power Connectors, Trunk #1 Male  
SH-BSM/2BKM..

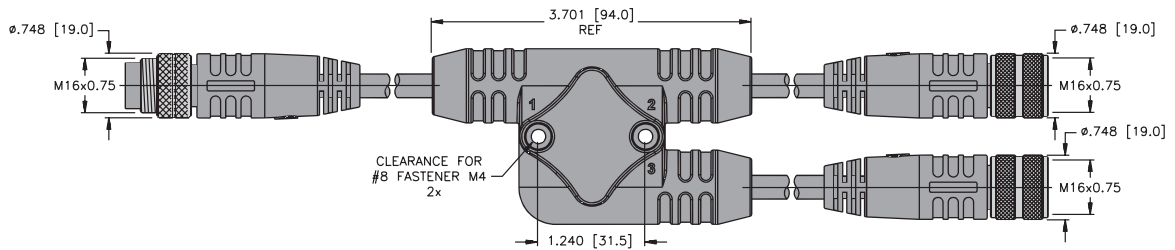

24

Cable Drop, Trunk #1 Male  
SH-BSM/BKM/T..

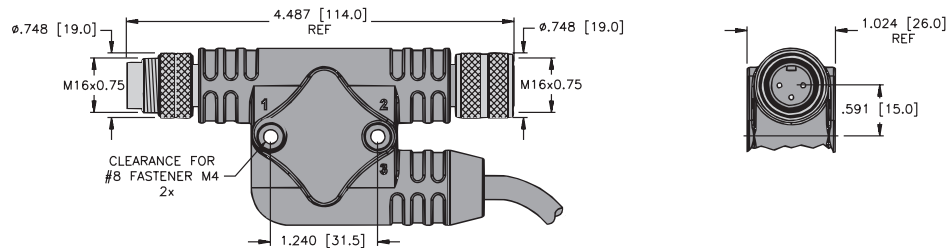

M16 Powerfast h-Style Tee Dimensions

25

**Integral M16 Power Connector Drop, Trunk #2 Male  
SH-BKM/BSM/BKM..**

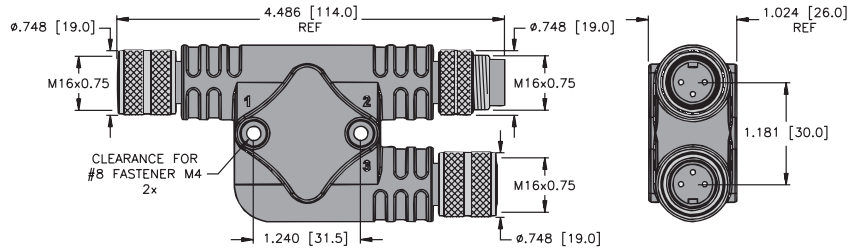

26

**Cable Drop with M16 Power Connector, Trunk #2 Male  
SH-BKM/BSM/BKM..**

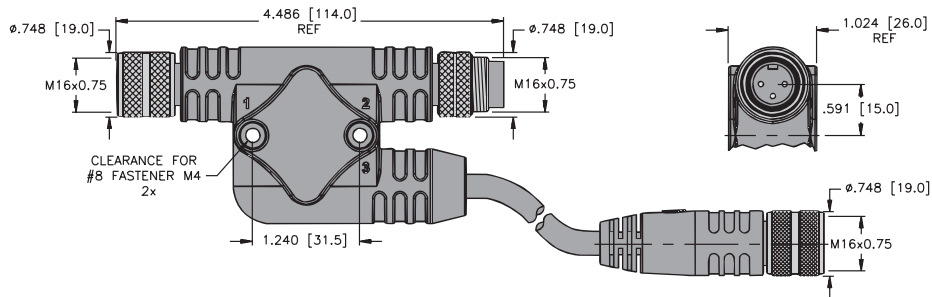

27

**Cable Trunk and Cable Drop with M16 Power Connectors, Trunk #2 Male  
SH-BKM/BSM/BKM..**

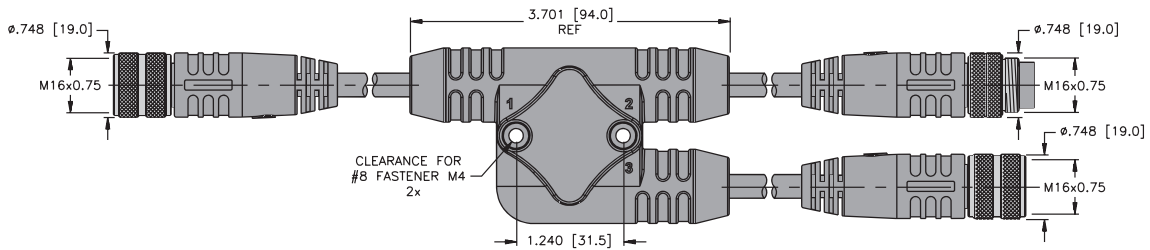

28

**Cable Drop, Trunk #2 Male  
SH-BKM/BSM/T..**

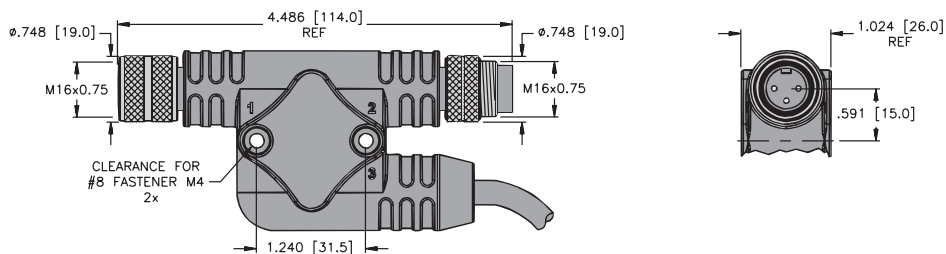

**M16 Powerfast H-Style Tee Dimensions**

29

**Integral M16 Power Connector Drop, Trunk #1 Male  
BH-BSM/3BKM..**

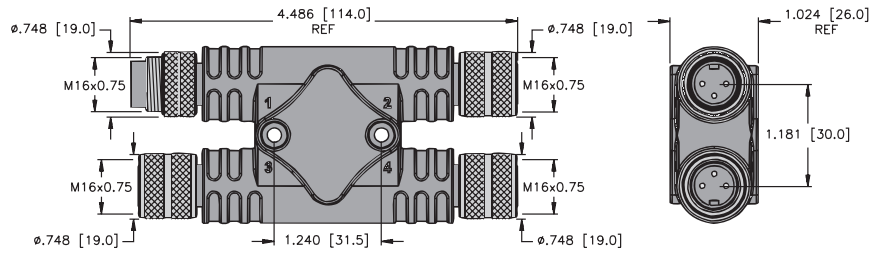

30

**Cable Drop with M16 Power Connector, Trunk #1 Male  
BH-BSM/3BKM..**

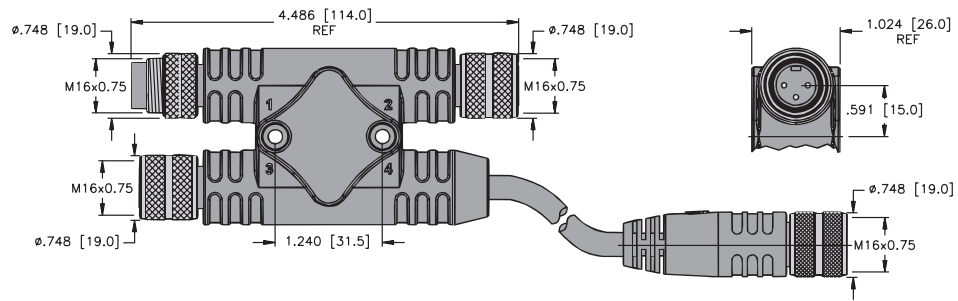

31

**Cable Trunk and Cable Drop with M16 Power Connectors, Trunk #1 Male  
BH-BSM/3BKM..**

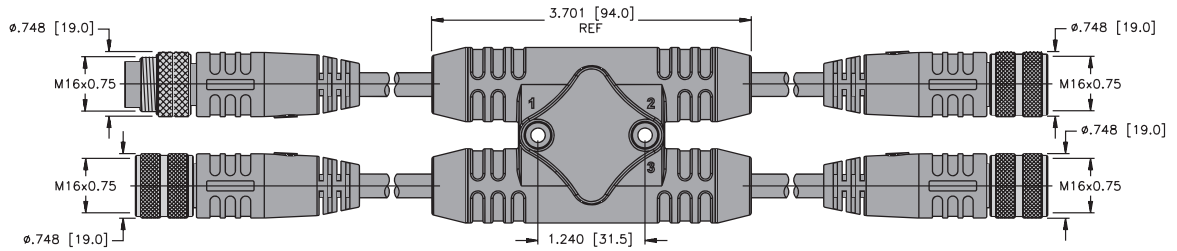

M16 powerfast

M16 Powerfast H-Style Tee Dimensions

32

**Integral M16 Power Connector Drop, Trunk #2 Male  
BH-BKM/BSM/2BKM..**

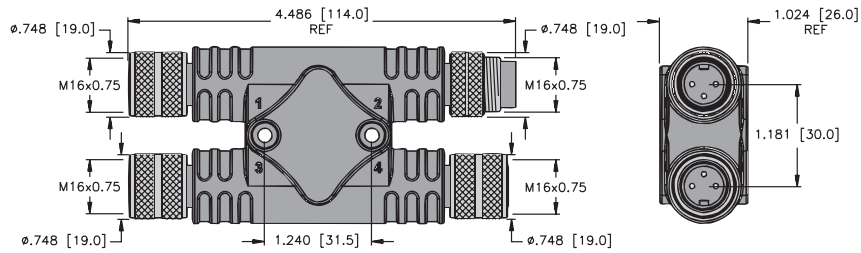

33

**Cable Drop with M16 Power Connector, Trunk #2 Male  
BH-BKM/BSM/2BKM..**

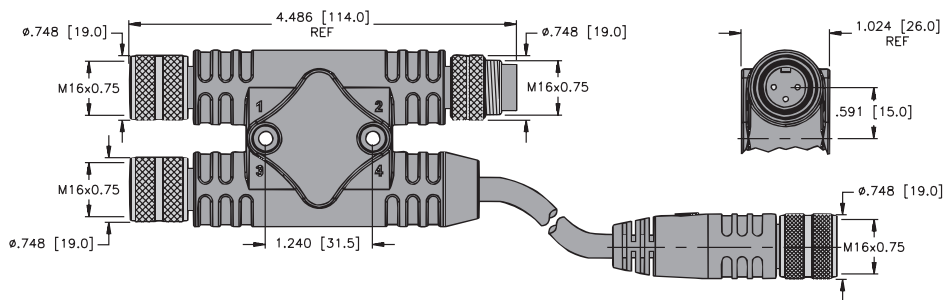

34

**Cable Trunk and Cable Drop with M16 Power Connectors, Trunk #2 Male  
BH-BKM/BSM/2BKM..**

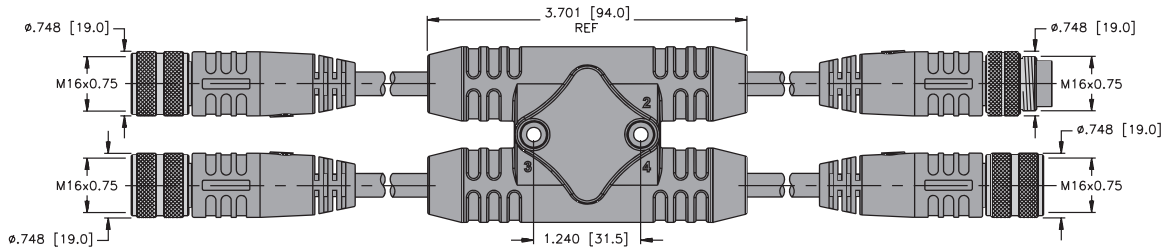

M16 Powerfast Tee Wiring Diagrams

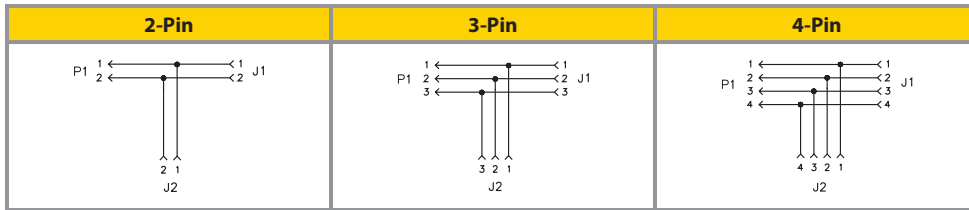

M16 Powerfast h-Style Tee Wiring Diagrams

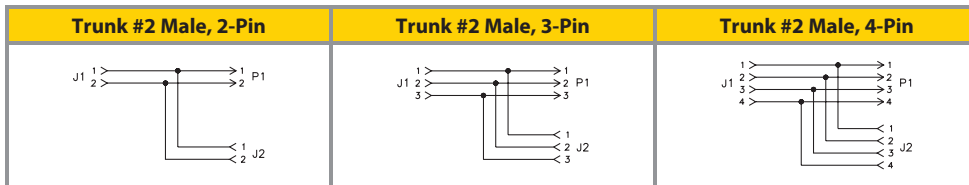
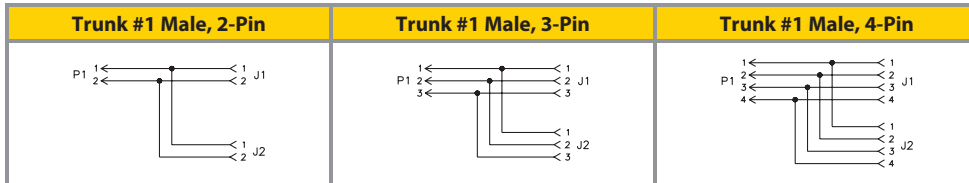

M16 Powerfast H-Style Tee Wiring Diagrams

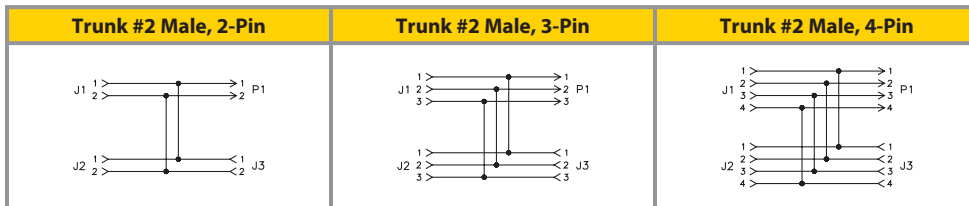
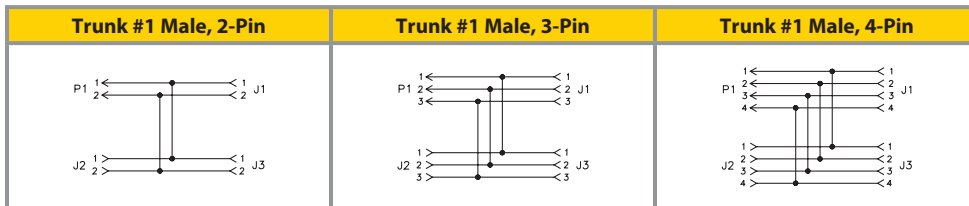

M16 Powerfast Tee Pinouts

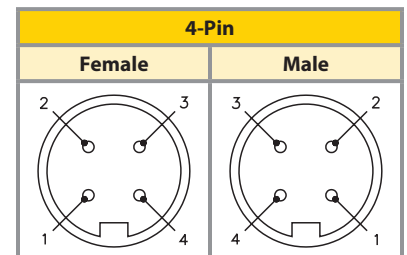
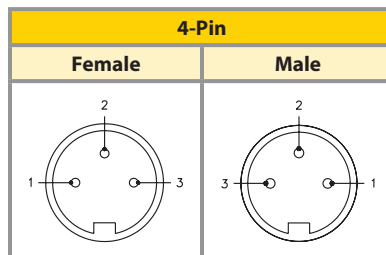
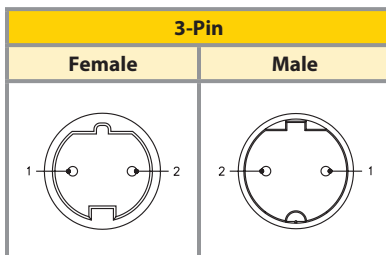

## M16 Powerfast Closure Cap Selection Matrix

|                     |        | 35                                     | 36                                       | 37                        | 38                          | 39                                     | 40                                       |
|---------------------|--------|--|--|---------------------------|-----------------------------|--|--|
|                     |        | Mates to male cordsets and receptacles | Mates to female cordsets and receptacles | Mates to male receptacles | Mates to female receptacles | Mates to male cordsets and receptacles | Mates to female cordsets and receptacles |
| Material            | Thread | 6" SS Loop Lanyard                     | 6" SS Loop Lanyard                       | 6" SS Lanyard with Eyelet | 6" SS Lanyard with Eyelet   | No Lanyard                             | No Lanyard                               |
| Nickel Plated Brass | M16    | BKM-CC                                 | BSM-CC                                   | BKF-CC                    | BSK-CC                      | BKM-MC                                 | BSM-MC                                   |

See table below for dimensional drawings.

## M16 Powerfast Closure Cap Dimensions

|                          |                          |                          |
|--------------------------|--------------------------|--------------------------|
| <p><b>35 GKDM-CC</b></p> | <p><b>36 GSDM-CC</b></p> | <p><b>37 GKDF-CC</b></p> |
| <p><b>38 GSDF-CC</b></p> | <p><b>39 GKDM-MC</b></p> | <p><b>40 GSDM-MC</b></p> |

## M16 Powerlok

| Part Number  | Application   |
|--------------|---|
| LOCK-M16     | Nylon locking guard for straight M16 Powerfast connectors |
| LOCK-M16-TEE |   |

M16 Powerlok Open



M16 Powerlok Closed



|  |            |
|--|------------|
| <b>Part Number Keys</b>                        | <b>J44</b> |
| <b>Cordset and Receptacle Specifications</b>   | <b>J45</b> |
| <b>Cordset and Receptacle Selection Matrix</b> | <b>J46</b> |
| <b>Cordset and Receptacle Dimensions</b>       | <b>J47</b> |
| <b>Cordset and Receptacle Pinouts</b>          | <b>J48</b> |

## Features

- Options for combination of power and signal wires in one cable
- Shielded versions available
- 6 to 9-pin
- 12 to 14 AWG conductors for power, 18 AWG conductors for signal
- Up to 30 Amp, 600 Volt rated for power
- Up to 8 Amp, 300 Volt rated for signal
- AWM or tray rated-exposed run PVC cable
- IEC IP67 protection



## M23 Powerfast Cordset Part Number Key

Part Number Keys are to assist in IDENTIFICATION ONLY. Consult factory for catalog items not identified.

|   |              |               |   |  |             |
|---|--------------|---------------|---|--|-------------|
| <b>M23 (23 mm) Powerfast Cordset</b>      | <b>B S M</b> | <b>34-198</b> | - | <b>*</b>   | <b>/S..</b> |
| <b>Gender</b>                             |              |               |   |  |             |
| K = female contact holder, female threads |              |               |   |  |             |
| S = male contact holder, female threads   |              |               |   |  |             |
| SS = male contact holder, male threads    |              |               |   |  |             |
| <b>Configuration</b>                      |              |               |   |  |             |
| M = straight                              |              |               |   |  |             |
| WM = right angle                          |              |               |   |  |             |
| (blank) = straight assembled connector    |              |               |   |  |             |
| <b>Coupling Nut Material</b>              |              |               |   |  |             |
| (blank) = nickel plated brass             |              |               |   |  |             |
| V = stainless steel                       |              |               |   |  |             |
| S = shielded                              |              |               |   |  |             |
|   |              |               |   | <b>Varieties</b>   |             |
|   |              |               |   | (blank) = PVC jacket   |             |
|   |              |               |   | /S90 = PUR jacket  |             |
|   |              |               |   | <b>Length in Meters</b>  |             |
|   |              |               |   | <b>Number of Wires / AWG / Color Codes</b>                           |             |
|   |              |               |   | 64-078 = 6x14 AWG WH, RD, GN, OG, BK, BU                             |             |
|   |              |               |   | 74-079 = 7x14 AWG WH/BK, BK, WH, RD, OG, BU, GN                      |             |
|   |              |               |   | 94-080 = 3x14 & 6X18 AWG RD, WH, WH/BK, BU, OG, BK, GN/BK, GN, RD/BK |             |
|   |              |               |   | 622-059 = 6x12 AWG BU, RD, GN, BN, OG, YE                            |             |
|   |              |               |   | 822-287 = 4x12 & 4X18 AWG BU, GN, WH, BK, OG, RD, WH/BK, RD/BK       |             |
|   |              |               |   | 622-286 = 6x12 AWG BU, RD, GN, BN, OG, YE                            |             |
|   |              |               |   | 822-288 = 4x12 & 4X18 AWG BU, GN, WH, BK, OG, RD, WH/BK, RD/BK       |             |
|   |              |               |   | <b>Insertion Point of Extension Cable Second Prefix*</b>             |             |
|   |              |               |   | * Male connector listed first, female connector second               |             |
|   |              |               |   | Example: <u>CSM CKM 64-078-1</u>                                     |             |

### Extension Examples

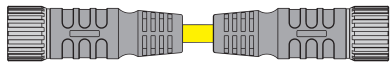

**C K M**

**C K M**

**74-079** - **\*** **/S..**

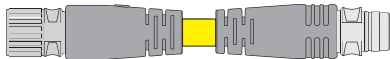

**C SS M**

**C K M**

**622-059** - **\*** **/S..**

## M23 Powerfast Receptacle Part Number Key

|   |              |             |   |  |
|---|--------------|-------------|---|--|
| <b>M23 (23 mm) Powerfast Cordset</b>    | <b>C K F</b> | <b>64-6</b> | - | <b>*</b>   |
| <b>Gender</b>                           |              |             |   |  |
| K = female contact holder, male threads |              |             |   |  |
| S = male contact holder, male threads   |              |             |   |  |
| <b>Designator for Receptacle</b>        |              |             |   |  |
|   |              |             |   | <b>Length in Meters</b>  |
|   |              |             |   | <b>Number of Wires / AWG / Color Codes</b>                         |
|   |              |             |   | 64-6 = 6x14 AWG WH, RD, GN, OG, BK, BU                             |
|   |              |             |   | 74-7 = 7x14 AWG WH/BK, BK, WH, RD, OG, BU, GN                      |
|   |              |             |   | 94-9 = 3x14 & 6X18 AWG RD, WH, WH/BK, BU, OG, BK, GN/BK, GN, RD/BK |
|   |              |             |   | 622-6 = 6x12 AWG BU, RD, GN, BN, OG, YE                            |
|   |              |             |   | 822-8 = 4x12 & 4X18 AWG BU, GN, WH, BK, OG, RD, WH/BK, RD/BK       |
|   |              |             |   | <b>Number of Wires / AWG / Color Codes</b>                         |
|   |              |             |   | (blank) = front mount  |
|   |              |             |   | D = rear mount   |
|   |              |             |   | F = flange   |
|   |              |             |   | MF = flange, rotating coupling nut                                 |
|   |              |             |   | L = front mount, long threads                                      |



**M23 Powerfast Single Keyway Cordset Specifications**

**Mechanical**

|                                  |                                       |
|----------------------------------|---------------------------------------|
| <b>Mold material/color:</b>      | PUR/Black                             |
| <b>Contact carrier material:</b> | Nylon or PBT                          |
| <b>Coupling nut material:</b>    |                                       |
| Standard:                        | Nickel plated brass                   |
| Additional options:              | 316 stainless steel                   |
| <b>Environmental protection:</b> | IEC IP67                              |
| <b>Temperature rating:</b>       | -40 °C to +105 °C (-40 °F to +221 °F) |

**Electrical**

|                                     |                         |
|-------------------------------------|-------------------------|
| <b>Contact material:</b>            | Brass with gold plating |
| <b>Cable jacket material/color:</b> | PVC/Yellow              |
| <b>Ratings:</b>                     |                         |
| Power:                              | 20 Amps, 300 V          |
| Signal:                             | 8 Amps, 150 V           |

**M23 Powerfast 3-Key Cordset Specifications**

**Mechanical**

|                                  |                                      |
|----------------------------------|--------------------------------------|
| <b>Mold material/color:</b>      | PUR/Black                            |
| <b>Contact carrier material:</b> | Nylon or PBT                         |
| <b>Coupling nut material:</b>    |                                      |
| Standard:                        | Nickel plated brass                  |
| <b>Environmental protection:</b> | IEC IP67                             |
| <b>Temperature rating:</b>       | -40 °C to +90 °C (-40 °F to +194 °F) |

**Electrical**

|                                     |                         |
|-------------------------------------|-------------------------|
| <b>Contact material:</b>            | Brass with gold plating |
| <b>Cable jacket material/color:</b> | TC-ER PVC/Yellow        |
| <b>Ratings:</b>                     |                         |
| Power:                              | 30 Amps, 600 V          |
| Signal:                             | 9 Amps, 300 V           |

**M23 Powerfast Single Keyway Receptacle Specifications**

**Mechanical**

|                                  |                                   |
|----------------------------------|-----------------------------------|
| <b>Contact carrier material:</b> | Nylon or PBT                      |
| <b>Housing material/plating:</b> |                                   |
| Standard:                        | Nickel plated brass               |
| Additional options:              | 316 stainless steel               |
| <b>Environmental protection:</b> | IEC IP67                          |
| <b>Temperature rating:</b>       | -30 to +90 °C (-40 °F to +194 °F) |

**Electrical**

|                              |                         |
|------------------------------|-------------------------|
| <b>Contact material:</b>     | Brass with gold plating |
| <b>Conductor insulation:</b> | PVC                     |
| <b>Ratings:</b>              |                         |
| Power:                       | 20 Amps, 300 V          |
| Signal:                      | 8 Amps, 150 V           |

**M23 Powerfast 3-Key Receptacle Specifications**

**Mechanical**

|                                  |                                   |
|----------------------------------|-----------------------------------|
| <b>Contact carrier material:</b> | Nylon or PBT                      |
| <b>Housing material/plating:</b> |                                   |
| Standard:                        | Nickel plated brass               |
| <b>Environmental protection:</b> | IEC IP67                          |
| <b>Temperature rating:</b>       | -30 to +80 °C (-40 °F to +176 °F) |



**Electrical**

|                              |                         |
|------------------------------|-------------------------|
| <b>Contact material:</b>     | Brass with gold plating |
| <b>Conductor insulation:</b> | PVC                     |
| <b>Ratings:</b>              |                         |
| Power:                       | 30 Amps, 600 V          |
| Signal:                      | 9 Amps, 300 V           |





We reserve the right to make technical alterations without prior notice.

M23 powerfast

## M23 Powerfast Single Keyway Cordset Selection Matrix





|      |            |                                     | 1  | 2  | 3  |
|------|------------|-------------------------------------|---|--|---|
|      |            |                                     | Straight Female   | Straight Male  | Straight Male   |
| Pins | AWG        | Current Rating                      | Single Keyway   | Single Keyway  | Single Keyway   |
| 6    | 14         | 20 Amps                             | CKM 64-078-*  | CSM 64-078-*   | CSSM 64-078-*   |
| 7    | 14         | 20 Amps                             | CKM 74-079-*  | CSM 74-079-*   | CSSM 74-079-*   |
| 9    | 3x14; 6x18 | 8 Amps (1-3,5,7,9), 20 Amps (4,6,8) | CKM 94-080-*  | CSM 94-080-*   | CSSM 94-080-*   |

## M23 Powerfast 3-Key Cordset Selection Matrix



|      |            |                             | 4  | 5  | 6  | 7  |
|------|------------|-----------------------------|---|--|---|---|
|      |            |                             | Straight Female   | Straight Male  | Right Angle Female  | Right Angle Male  |
| Pins | AWG        | Current Rating              | 3-Key   | 3-Key  | 3-Key   | 3-Key   |
| 6    | 12         | 30 Amps                     | CKM 622-059-*   | CSSM 622-059-*   | CKWM 622-059-*  | CSSWM 622-059-*   |
| 8    | 4x12; 4x18 | 9 Amps (A-D), 30 Amps (1-4) | CKM 822-287-*   | CSSM 822-287-*   | CKWM 822-287-*  | CSSWM 822-287-*   |

| Pins | AWG        | Current Rating              | Shielded 3-Key | Shielded 3-Key  | Shielded 3-Key  | Shielded 3-Key   |
|------|------------|-----------------------------|----------------|-----------------|-----------------|------------------|
| 6    | 12         | 30 Amps                     | CKMS 622-286-* | CSSMS 622-286-* | CKWMS 622-286-* | CSSWMS 622-286-* |
| 8    | 4x12; 4x18 | 9 Amps (A-D), 30 Amps (1-4) | CKMS 822-288-* | CSSMS 822-288-* | CKWMS 822-288-* | CSSWMS 822-288-* |

## M23 Powerfast Single Keyway Receptacle Selection Matrix

|      |            |                                     | 8  | 9  | 10  | 11  |
|------|------------|-------------------------------------|---|--|--|--|
|      |            |                                     | Female  | Male   | Female   | Male   |
| Pins | AWG        | Current Rating                      | M20 Mount, Standard Thread  | M20 Mount, Standard Thread   | M20 Mounting, Long Thread  | M20 Mounting, Long Thread  |
| 6    | 14         | 20 Amps                             | CKF 64-6-*  | CSF 64-6-*   | CKFL 64-6-*  | CSFL 64-6-*  |
| 7    | 14         | 20 Amps                             | CKF 74-7-*  | CSF 74-7-*   | CKFL 74-7-*  | CSFL 74-7-*  |
| 9    | 3x14; 6x18 | 8 Amps (1-3,5,7,9), 20 Amps (4,6,8) | CKF 94-9-*  | CSF 94-9-*   | CKFL 94-9-*  | CSFL 94-9-*  |

## M23 Powerfast 3-Key Receptacle Selection Matrix

|      |            |                             | 12  | 13  | 14  |
|------|------------|-----------------------------|--|---|--|
|      |            |                             | Female   | Male  | Male   |
| Pins | AWG        | Current Rating              | Flange Mount   | Flange Mount  | M20 Mounting Thread  |
| 6    | 12         | 30 Amps                     | CKFMF 622-6-*  | CSFF 622-6-*  | CSF 622-6-*  |
| 8    | 4x12; 4x18 | 9 Amps (A-D), 30 Amps (1-4) | CKFMF 822-8-*  | CSFF 822-8-*  | CSF 822-8-*  |

See pages 47-48 for dimensional drawings.

\* Length in meters. Standard cable lengths are 2, 5 and 10 meters. Standard lead length is 0.5 meters. Consult factory for other lengths.

Note: Extension cables are available, please consult Part Number Key (page 42).

Standard coupling nut and housing material is nickel plated brass. Consult Part Number Key (page 42) for 316 stainless steel options.

We reserve the right to make technical alterations without prior notice.

**M23 Powerfast Single Keyway Cordset Dimensions**

1 & 2

**CKM (CSM)..**

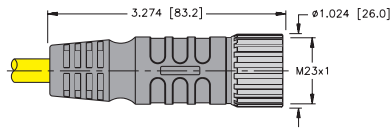

3

**CSSM..**

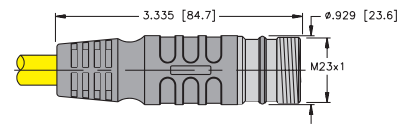

**M23 Powerfast 3-Key Cordset Dimensions**

4

**CKM..**

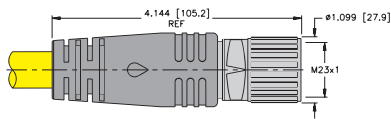

5

**CSSM..**

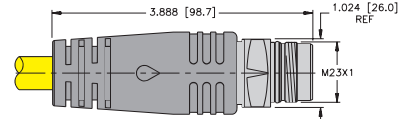

6

**CKWM..**

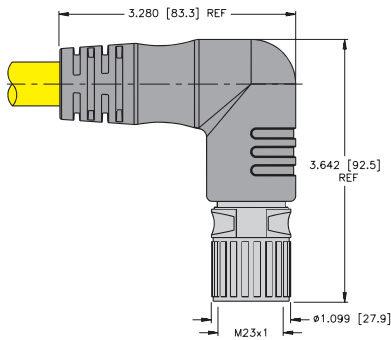

7

**CSSWM..**

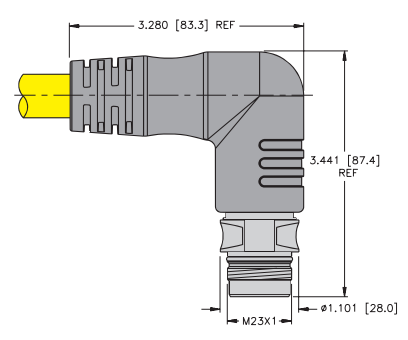

M23 powerfast

**M23 Powerfast Single Keyway Receptacle Dimensions**

8 & 9

**CKF (CSF)..**

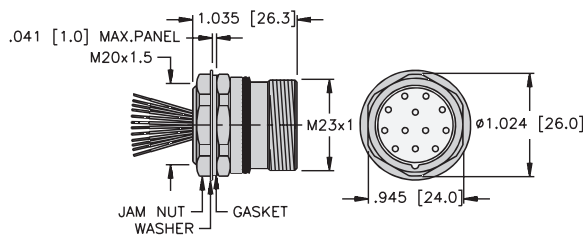

10 & 11

**CKFL (CSFL) ..**

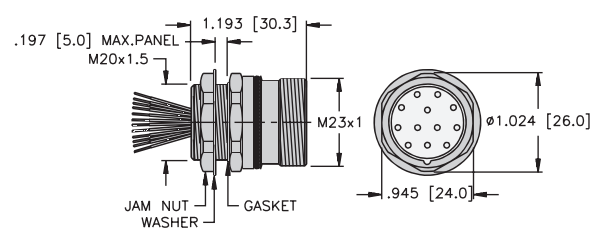

## M23 Powerfast 3-Key Receptacle Dimensions

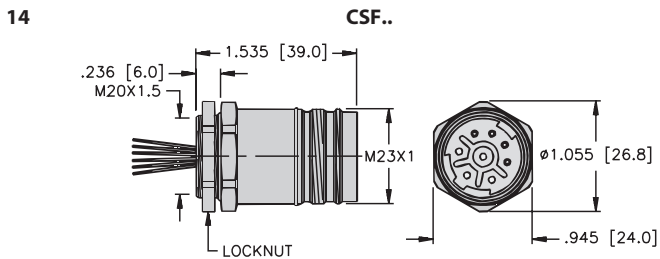
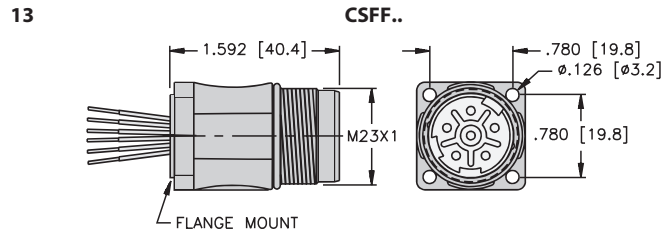
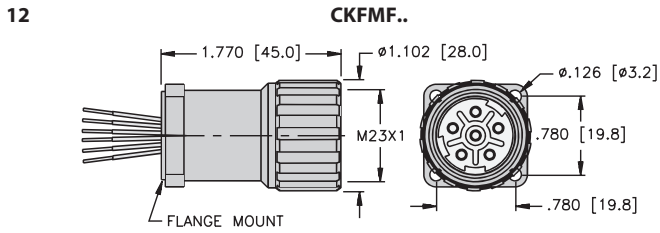

## M23 Powerfast Single Keyway Cordset and Receptacle Pinouts

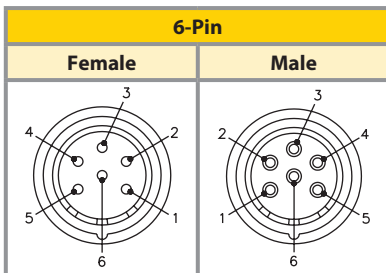

- Pinouts**
1. WH
  2. RD
  3. GN
  4. OG
  5. BK
  6. BU

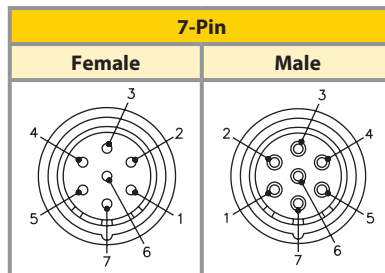

- Pinouts**
1. WH/BK
  2. BK
  3. WH
  4. RD
  5. OG
  6. BU
  7. GN

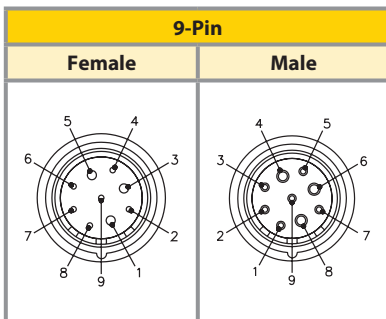

- Pinouts**
1. RD
  2. WH
  3. WH/BK
  4. BU
  5. OG
  6. BK
  7. GN/BK
  8. GN
  9. RD/BK

## M23 Powerfast 3-Key Cordset and Receptacle Pinouts

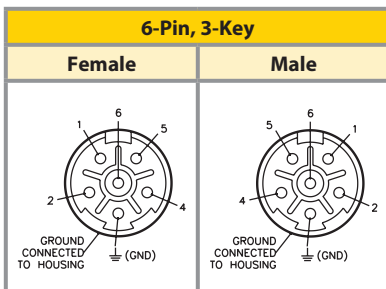

- Pinouts**
1. BU
  2. RD
  3. GN
  4. BN
  5. OG
  6. YE

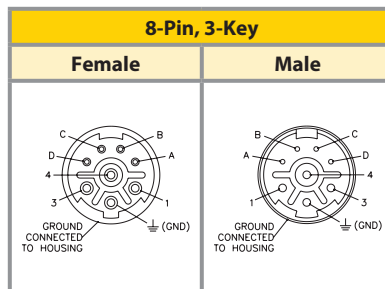

- Pinouts**
1. BU
  2. GN
  3. WH
  4. BK
  - A. OG
  - B. RD
  - C. WH/BK
  - D. RD/BK

|  |            |
|--|------------|
| <b>Part Number Keys</b>                                      | <b>J50</b> |
| <b>Cordset and Receptacle Specifications</b>                 | <b>J51</b> |
| <b>Cordset and Receptacle Selection Matrix</b>               | <b>J51</b> |
| <b>Cordset and Receptacle Dimensions</b>                     | <b>J52</b> |
| <b>Cordset and Receptacle Pinouts</b>                        | <b>J52</b> |
| <b>h-Style Tee, Jumper Plug and Extension Specifications</b> | <b>J53</b> |
| <b>h-Style Tee, Jumper Plug and Extension Matrix</b>         | <b>J54</b> |
| <b>h-Style Tee, Jumper Plug and Extension Dimensions</b>     | <b>J55</b> |
| <b>h-Style Tee, Jumper Plug and Extension Pinouts</b>        | <b>J55</b> |

## Features

- Options for combination of power & signal wires in one cable
- 8 AWG conductors for power
- 14 AWG and 18 AWG conductor options for signal
- Up to 35 Amp, 250 and 600 volt rated



## M40 Powerfast Cordset Part Number Key

Part Number Keys are to assist in IDENTIFICATION ONLY. Consult factory for catalog items not identified.

| H S M   |  |  |  | 4 8 0 0 |  |  |  | - |  | 1279 |  | - |  | * |  | /S.. |  |
|---|--|--|--|---------|--|--|--|---|--|------|--|---|--|---|--|------|--|
| <b>M40 Powerfast Cordset</b>  |  |  |  |         |  |  |  |   |  |      |  |   |  |   |  |      |  |
| <b>Gender</b>   |  |  |  |         |  |  |  |   |  |      |  |   |  |   |  |      |  |
| K = female connector, female threads  |  |  |  |         |  |  |  |   |  |      |  |   |  |   |  |      |  |
| S = male connector, male threads  |  |  |  |         |  |  |  |   |  |      |  |   |  |   |  |      |  |
| M = molded connector<br>(blank) = assembled connector   |  |  |  |         |  |  |  |   |  |      |  |   |  |   |  |      |  |
| <b>Shielding</b>  |  |  |  |         |  |  |  |   |  |      |  |   |  |   |  |      |  |
| S = shield tied to coupling nut   |  |  |  |         |  |  |  |   |  |      |  |   |  |   |  |      |  |
| <b>Housing Material</b>   |  |  |  |         |  |  |  |   |  |      |  |   |  |   |  |      |  |
| (blank) = nickel plated brass   |  |  |  |         |  |  |  |   |  |      |  |   |  |   |  |      |  |
| <b>Insertion Point for Second Connector*</b>  |  |  |  |         |  |  |  |   |  |      |  |   |  |   |  |      |  |
| * Male connector listed first, female connector second<br>Example: <b>HSM HKM 4800-1279-5</b> |  |  |  |         |  |  |  |   |  |      |  |   |  |   |  |      |  |
| <b>Number of Power Wires</b>  |  |  |  |         |  |  |  |   |  |      |  |   |  |   |  |      |  |
| 4 = 4 wires connected to power pins   |  |  |  |         |  |  |  |   |  |      |  |   |  |   |  |      |  |
| 3 = 3 wires connected to power pins   |  |  |  |         |  |  |  |   |  |      |  |   |  |   |  |      |  |
| <b>Varieties</b>  |  |  |  |         |  |  |  |   |  |      |  |   |  |   |  |      |  |
| /S... = consult factory   |  |  |  |         |  |  |  |   |  |      |  |   |  |   |  |      |  |
| /CS... = consult factory  |  |  |  |         |  |  |  |   |  |      |  |   |  |   |  |      |  |
| <b>Length in Meters</b>   |  |  |  |         |  |  |  |   |  |      |  |   |  |   |  |      |  |
| <b>Color Codes / Cable Type</b>   |  |  |  |         |  |  |  |   |  |      |  |   |  |   |  |      |  |
| 1279 = WH, BK, RD, GN, TC-ER TPE Black  |  |  |  |         |  |  |  |   |  |      |  |   |  |   |  |      |  |
| 1313 = WH, BK, RD, GN, TC-ER TPE Yellow   |  |  |  |         |  |  |  |   |  |      |  |   |  |   |  |      |  |
| 1314 = WH, BK, RD, GN, BK, WH, BN, BU, TC-ER TPE Black  |  |  |  |         |  |  |  |   |  |      |  |   |  |   |  |      |  |
| 1884 = BK"V", BK"U", BK"W". BU/YE"+", BU/YE"-", GN/YE, TC-ER/STOOW, PVC Black                 |  |  |  |         |  |  |  |   |  |      |  |   |  |   |  |      |  |
| <b>Gauge of Control Wires</b>   |  |  |  |         |  |  |  |   |  |      |  |   |  |   |  |      |  |
| 0 = no connection or 20 AWG wire to control wins  |  |  |  |         |  |  |  |   |  |      |  |   |  |   |  |      |  |
| 4 = 14 AWG Wire to control pins   |  |  |  |         |  |  |  |   |  |      |  |   |  |   |  |      |  |
| 6 = 16 AWG wire to control pins   |  |  |  |         |  |  |  |   |  |      |  |   |  |   |  |      |  |
| 8 = 18 AWG wire to control pins   |  |  |  |         |  |  |  |   |  |      |  |   |  |   |  |      |  |
| <b>Color Codes / Cable Type</b>   |  |  |  |         |  |  |  |   |  |      |  |   |  |   |  |      |  |
| 0 = no connection to control pins   |  |  |  |         |  |  |  |   |  |      |  |   |  |   |  |      |  |
| 2 = 2 control pins connected  |  |  |  |         |  |  |  |   |  |      |  |   |  |   |  |      |  |
| 4 = 4 control pins connected  |  |  |  |         |  |  |  |   |  |      |  |   |  |   |  |      |  |
| <b>Color Codes / Cable Type</b>   |  |  |  |         |  |  |  |   |  |      |  |   |  |   |  |      |  |
| 8 = 8 AWG wire to power pins  |  |  |  |         |  |  |  |   |  |      |  |   |  |   |  |      |  |
| 0 = 10 AWG wire to power pins   |  |  |  |         |  |  |  |   |  |      |  |   |  |   |  |      |  |

### Extension Examples

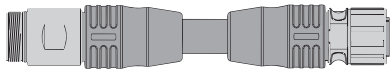

**H S M**    **H K M**    **4 8 0 0** - **1279** - **\*** /S..

## M23 Powerfast Receptacle Part Number Key

| H S F F  |  |  |  | 4 8 0 0 |  |  |  | - |  | * |  | /S.. |  |
|--|--|--|--|---------|--|--|--|---|--|---|--|------|--|
| <b>M40 Powerfast Receptacle</b>                  |  |  |  |         |  |  |  |   |  |   |  |      |  |
| <b>Gender</b>                                    |  |  |  |         |  |  |  |   |  |   |  |      |  |
| K = female connector, female threads             |  |  |  |         |  |  |  |   |  |   |  |      |  |
| S = male connector, male threads                 |  |  |  |         |  |  |  |   |  |   |  |      |  |
| <b>Designator for Receptacles</b>                |  |  |  |         |  |  |  |   |  |   |  |      |  |
| F = flange<br>MF = flange, rotating coupling nut |  |  |  |         |  |  |  |   |  |   |  |      |  |
| <b>Mounting Style</b>                            |  |  |  |         |  |  |  |   |  |   |  |      |  |
| F = flange<br>MF = flange, rotating coupling nut |  |  |  |         |  |  |  |   |  |   |  |      |  |
| <b>Number of Power Wires</b>                     |  |  |  |         |  |  |  |   |  |   |  |      |  |
| 4 = 4 wires connected to power pins              |  |  |  |         |  |  |  |   |  |   |  |      |  |
| 3 = 3 wires connected to power pins              |  |  |  |         |  |  |  |   |  |   |  |      |  |
| <b>Varieties</b>                                 |  |  |  |         |  |  |  |   |  |   |  |      |  |
| /S... = consult factory                          |  |  |  |         |  |  |  |   |  |   |  |      |  |
| /CS... = consult factory                         |  |  |  |         |  |  |  |   |  |   |  |      |  |
| <b>Length in Meters</b>                          |  |  |  |         |  |  |  |   |  |   |  |      |  |
| <b>Gauge of Control Wires</b>                    |  |  |  |         |  |  |  |   |  |   |  |      |  |
| 0 = no connection or 20 AWG wire to control pins |  |  |  |         |  |  |  |   |  |   |  |      |  |
| 4 = 14 AWG wire to control pins                  |  |  |  |         |  |  |  |   |  |   |  |      |  |
| 6 = 16 AWG wire to control pins                  |  |  |  |         |  |  |  |   |  |   |  |      |  |
| 8 = 18 AWG wire to control pins                  |  |  |  |         |  |  |  |   |  |   |  |      |  |
| <b>Number of Control Wires</b>                   |  |  |  |         |  |  |  |   |  |   |  |      |  |
| 0 = no connection to control pins                |  |  |  |         |  |  |  |   |  |   |  |      |  |
| 2 = 2 control pins connected                     |  |  |  |         |  |  |  |   |  |   |  |      |  |
| 4 = 4 control pins connected                     |  |  |  |         |  |  |  |   |  |   |  |      |  |
| <b>Gauge of Power Wires</b>                      |  |  |  |         |  |  |  |   |  |   |  |      |  |
| 8 = 8 AWG wire to power pins                     |  |  |  |         |  |  |  |   |  |   |  |      |  |
| 0 = 10 AWG wire to power pins                    |  |  |  |         |  |  |  |   |  |   |  |      |  |

M40 Powerfast Cordset Specifications

Mechanical

|                                  |                                      |
|----------------------------------|--------------------------------------|
| <b>Mold material/color:</b>      | Polyamide/Black                      |
| <b>Contact carrier material:</b> | Nylon                                |
| <b>Coupling nut material</b>     | Nickel plated brass                  |
| <b>Environmental protection:</b> | IEC IP67                             |
| <b>Temperature rating:</b>       | -40 °C to +90 °C (-40 °F to +194 °F) |

Electrical

|                                     |                                   |
|-------------------------------------|-----------------------------------|
| <b>Contact material:</b>            | Brass or copper with gold plating |
| <b>Cable jacket material/color:</b> | TC-ER PVC                         |
| <b>Ratings:</b>                     |                                   |
| Power:                              | 35 Amps, 600 VAC                  |
| Signal:                             | 4-9 Amps, 250 VAC                 |



M40 Powerfast Receptacle Specifications

Mechanical

|                                  |                                       |
|----------------------------------|---------------------------------------|
| <b>Contact carrier material:</b> | Nylon                                 |
| <b>Housing material/plating:</b> | Nickel plated brass                   |
| <b>Environmental protection:</b> | IEC IP67                              |
| <b>Temperature rating:</b>       | -40 °C to +105 °C (-40 °F to +221 °F) |

Electrical

|                              |                                   |
|------------------------------|-----------------------------------|
| <b>Contact material:</b>     | Brass or copper with gold plating |
| <b>Conductor insulation:</b> | PVC                               |
| <b>Ratings:</b>              |                                   |
| Power:                       | 35 Amps, 600 VAC                  |
| Signal:                      | 4-9 Amps, 250 VAC                 |



M40 Powerfast Cordset Selection Matrix

| Front Mount |           |                                  | 1               | 2               | 3                  | 4                |
|-------------|-----------|----------------------------------|-----------------|-----------------|--------------------|------------------|
|             |           |                                  |                 |                 |                    |                  |
| Pins        | AWG       | Current Rating                   | Straight Female | Straight Male   | Right Angle Female | Right Angle Male |
| 4           | 8         | 35 Amps                          | HKM 4800-1279-* | HSM 4800-1279-* | HKWM 4800-1279-*   | HSWM 4800-1279-* |
| 6           | 4x8; 2x14 | 35 Amps (8 AWG), 9 Amps (14 AWG) | HKM 4824-1884-* | HSM 4824-1884-* | HKWM 4824-1884-*   | HSWM 4824-1884-* |
| 8           | 4x8; 4x18 | 35 Amps (8 AWG), 4 Amps (18 AWG) | HKM 4848-1314-* | HSM 4848-1314-* | HKWM 4848-1314-*   | HSWM 4848-1314-* |

M40 Powerfast Receptacle Selection Matrix

| Front Mount |           |                                  | 5                      | 6                    |
|-------------|-----------|----------------------------------|------------------------|----------------------|
|             |           |                                  |                        |                      |
| Pins        | AWG       | Current Rating                   | Female<br>Flange Mount | Male<br>Flange Mount |
| 4           | 8         | 35 Amps                          | HKFMF 4800-*           | HSFF 4800-*          |
| 6           | 4x8; 2x14 | 35 Amps (8 AWG), 9 Amps (14 AWG) | HKFMF 4824-*           | HSFF 4824-*          |
| 8           | 4x8; 4x18 | 35 Amps (8 AWG), 4 Amps (18 AWG) | HKFMF 4848-*           | HSFF 4848-*          |

We reserve the right to make technical alterations without prior notice.

M40 powerfast

## M40 Powerfast Cordset and Receptacle Dimensions

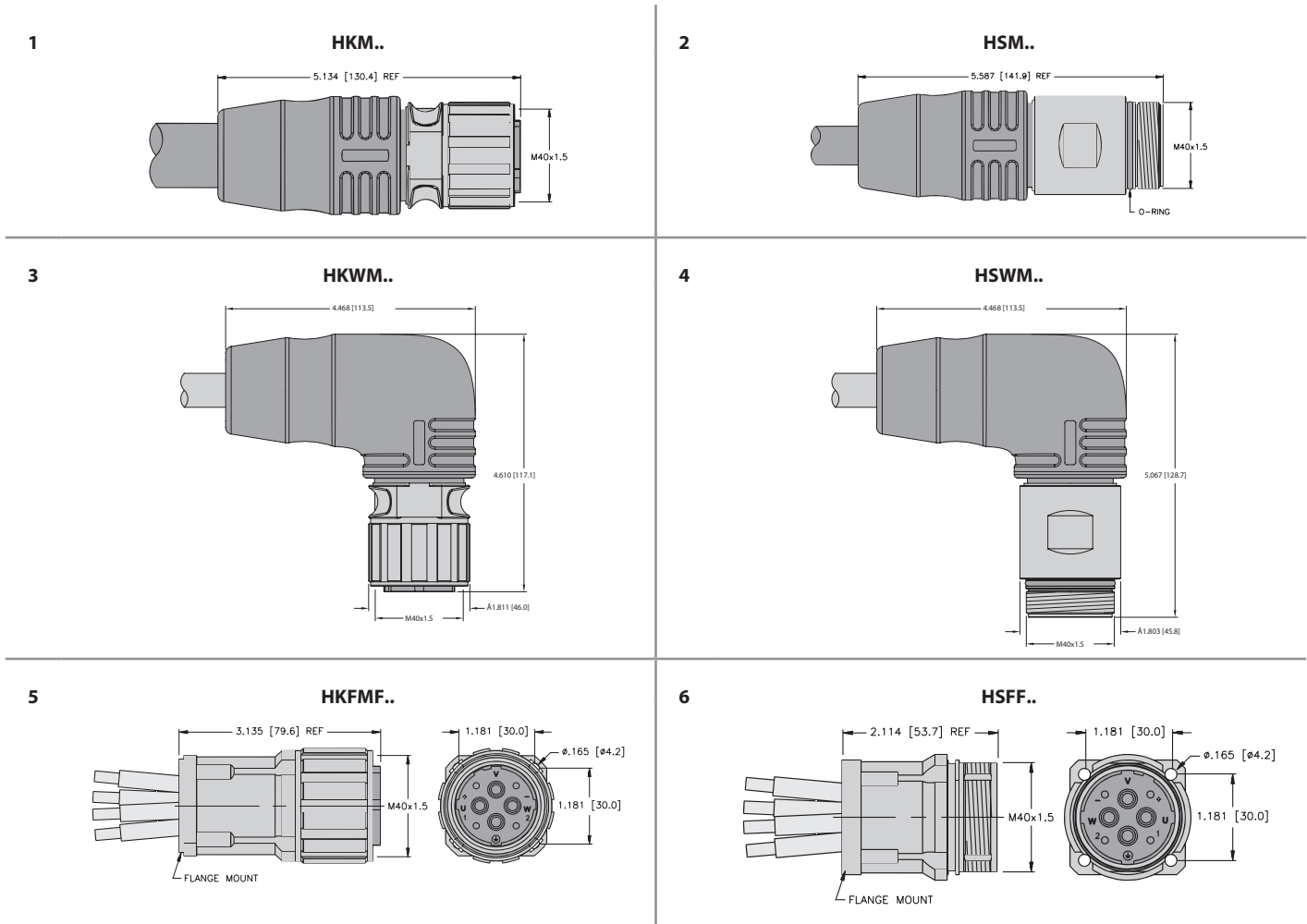

## M40 Powerfast Cordset and Receptacle Pinouts

| 4-Pin  |      | Pinouts   | 6-Pin  |      | Pinouts   |
|--------|------|---|--------|------|---|
| Female | Male | V. WH<br>U. BK<br>W. RD<br>$\pm$ . GN<br>+. N/C<br>-. N/C<br>1. N/C<br>2. N/C | Female | Male | V. Black V<br>U. Black U<br>W. Black W<br>$\pm$ . GN/YE<br>+. BU/YE "+"<br>-. BU/YE "-" |
|        |      |   |        |      |   |
| 8-Pin  |      | Pinouts   |        |      |   |
| Female | Male | V. WH<br>U. BK<br>W. RD<br>$\pm$ . GN<br>+. BK<br>-. BU<br>1. WH<br>2. BN     |        |      |   |
|        |      |   |        |      |   |



**M40 Powerfast h-Style Tee Specifications**

**Mechanical**

|                                  |                                      |
|----------------------------------|--------------------------------------|
| <b>Mold material/color:</b>      | Polyamide/Black                      |
| <b>Contact carrier material:</b> | Nylon                                |
| <b>Coupling nut material</b>     | Nickel plated brass                  |
| <b>Environmental protection:</b> | IEC IP67                             |
| <b>Temperature rating:</b>       | -40 °C to +90 °C (-40 °F to +194 °F) |

**Electrical**

|                          |                                   |
|--------------------------|-----------------------------------|
| <b>Contact material:</b> | Brass or copper with gold plating |
| <b>Ratings:</b>          |                                   |
| Power:                   | 35 Amps, 600 VAC                  |
| Signal:                  | 9 Amps, 250 VAC                   |



**M40 Powerfast Jumper Plug Specifications**

**Mechanical**

|                                  |                                      |
|----------------------------------|--------------------------------------|
| <b>Mold material/color:</b>      | Polyamide/Black                      |
| <b>Contact carrier material:</b> | Nylon                                |
| <b>Coupling nut material</b>     | Nickel plated brass                  |
| <b>Environmental protection:</b> | IEC IP67                             |
| <b>Temperature rating:</b>       | -40 °C to +90 °C (-40 °F to +194 °F) |

**Electrical**

|                          |                                   |
|--------------------------|-----------------------------------|
| <b>Contact material:</b> | Brass or copper with gold plating |
| <b>Ratings:</b>          |                                   |
| Power:                   | 35 Amps, 600 VAC                  |
| Signal:                  | 9 Amps, 250 VAC                   |



**M40 Powerfast to Harting Connector Specifications**

**Mechanical**

|                                  |                                      |
|----------------------------------|--------------------------------------|
| <b>Mold material/color:</b>      |                                      |
| M40 connector:                   | Polyamide/Black                      |
| <b>Hood material/color:</b>      |                                      |
| Harting connector:               | Zinc die-cast/Black (Harting)        |
| <b>Contact carrier material:</b> |                                      |
| M40 connector:                   | Nylon                                |
| Harting connector:               | Polycarbonate                        |
| <b>Coupling nut material:</b>    |                                      |
| M40 connector:                   | Nickel plated brass                  |
| <b>Environmental protection:</b> |                                      |
| M40 connector:                   | IEC IP67                             |
| Harting connector:               | IEC IP65                             |
| <b>Temperature rating:</b>       | -40 °C to +90 °C (-40 °F to +194 °F) |

**Electrical**

|                               |  |
|-------------------------------|--|
| <b>Contact material:</b>      |  |
| M40 connector:                | Brass or copper with gold plating          |
| Harting connector:            | Copper alloy with gold over silver plating |
| <b>Cable jacket material:</b> |  |
| Standard:                     | TC-ER STOOW PVC                            |
| Additional options:           | TC-ER PVC (/S4000 version)                 |
| <b>Ratings:</b>               | 20 Amps, 600 VAC                           |

We reserve the right to make technical alterations without prior notice.

M40 powerfast

## M40 Powerfast h-Style Tee Selection Matrix



| Pins | Drop AWG  | Trunk Current Rating             | Drop Current Rating              | Integral M40 Connector Drop |
|------|-----------|----------------------------------|----------------------------------|-----------------------------|
| 6    | 4x8; 2x14 | 35 Amps (8 AWG), 6 Amps (14 AWG) | 35 Amps (8 AWG), 9 Amps (14 AWG) | SH-HSM/2 HKM 4824           |

## M40 Powerfast Jumper Plug Selection Matrix



| Pins | AWG       | Current Rating                   | Male          |
|------|-----------|----------------------------------|---------------|
| 6    | 4x8; 2x14 | 35 Amps (8 AWG), 9 Amps (14 AWG) | HSM 4824/J+ - |

## M40 Powerfast to Harting Connector Selection Matrix



| Pins | AWG       | Current Rating                    | TC-ER                        | TC-ER STOOW            |
|------|-----------|-----------------------------------|------------------------------|------------------------|
| 6    | 4x8; 2x14 | 20 Amps (12 AWG), 9 Amps (14 AWG) | HSM 40 HANQW4/2-1850-*/S4000 | HSM 40 HANQW4/2-1668-* |

We reserve the right to make technical alterations without prior notice.

M40 Powerfast h-Style Tee and Jumper Plug Receptacle Dimensions

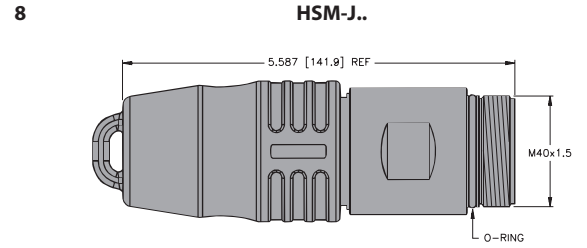
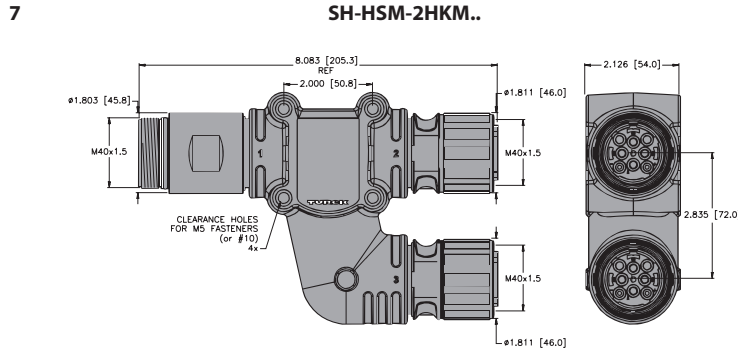

M40 Powerfast to Harting Receptacle Dimensions

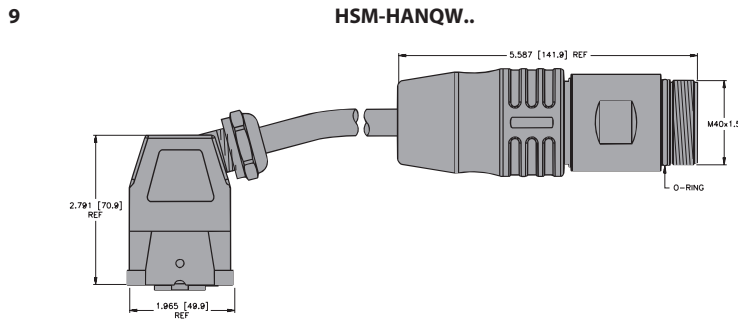

M40 Powerfast h-Style Wiring Diagram

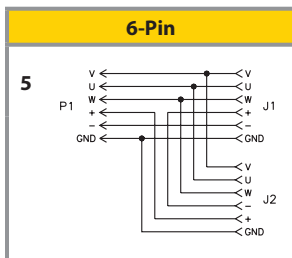

M40 Powerfast Jumper Plug and M40 Powerfast to Harting Connector Pinouts

| 6-Pin Male | Pinouts  | 6-Pin Male | Pinouts  | 6-Pin Female | Pinouts  |
|------------|--|------------|--|--------------|--|
|            | V. N/C<br>U. N/C<br>W. N/C<br>±. N/C<br>+. Jumper to "-"<br>-. Jumper to "+" |            | 1. RD<br>2. WH<br>3. BK<br>±. GN<br>4. N/C<br>11. N/C<br>12. N/C |              | U. RD<br>V. WH<br>W. BK<br>±. GN<br>+. Jumper to "-"<br>-. Jumper to "+" |



|                             |            |
|-----------------------------|------------|
| <b>Part Number Keys</b>     | <b>K3</b>  |
| <b>Cordsets</b>             | <b>K6</b>  |
| <b>Receptacles</b>          | <b>K13</b> |
| <b>EtherNet/IP Cordsets</b> | <b>K16</b> |
| <b>Field Wireables</b>      | <b>K23</b> |

## Features

- CAT 5e rated cables
- 2 pair and 4 pair cable option
- 8-pin and 4-pin D-coded connectors
- M12 and RJ45 connectors
- Up to 4 Amp and 250 Volt rated
- IP67/IP69K rated



## System Description

Ethernet is the most popular protocol used to connect office computers and peripherals today. It is increasingly finding its way into other applications, and is rapidly becoming the network of choice for higher level industrial control applications. Ethernet is primarily used to connect PLCs, computers, HMI displays and other high level components.

The term "Ethernet" actually refers to the lower level communication structure. Various different versions, or implementations, of Ethernet are available, such as EtherNet/IP™ and Modbus-TCP. It is important to note that while all of these different specifications use the same physical communication method and can operate on the same cable simultaneously, they cannot necessarily communicate with each other. For example, Modbus-TCP devices cannot communicate with EtherNet/IP devices. This is because the messages and communication protocol have been defined differently for these systems, even though the physical electrical structure is the same. Think of it as two people who speak different languages; they speak by moving air with their mouths, but the rules of the languages are different.

Turck's BL67 Ethernet gateways provide a convenient way to connect industrial I/O devices directly to the Ethernet system, expediting monitoring and troubleshooting for the overall control scheme.

## Typical System Configuration

### Basic Parts List

A typical Ethernet system consists of the following parts:

- Controller
- Ethernet I/O modules
- Power supply
- Switches
- Ethernet cable

Ethernet I/O modules act as clients on a network. A server device is needed to retrieve data from and post data to the client. This is analogous to an office network, where the client PC on a user's desk may actively connect with multiple servers to access information in different areas of the enterprise. Turck Ethernet stations are designed to be fully compatible with established Ethernet standards for industrial use.

## Cordsets

Turck offers a complete line of molded Ethernet cordsets to facilitate network installation, resulting in a faster start-up and fewer wiring errors. Cables are available with stranded or solid-core conductors, with or without shielding.

Most Turck Ethernet equipment uses the 4 or 8-pin (M12) Eurofast® connector specifications. These connectors provide a tough, rugged seal, and are IP 67 rated. In some cases (mainly in the control cabinet) a traditional RJ45 Ethernet connector needs to be used. Turck provides RJ45 cordsets, as well as a variety of devices made to convert between RJ45 and Eurofast connectors. Turck cordsets for the Ethernet system are available in standard lengths. Please contact your local sales representative to order custom lengths.

## Maximum Lengths Ratings

Ethernet allows different maximum cable lengths depending on the type of cable being used. An Ethernet segment may be as long as 100 m, with up to 90 m solid core cable and the remaining 10 m can be stranded patch cords.

## Eurofast® Cordset Part Number Key

Part Number Keys are to assist in IDENTIFICATION ONLY. Consult factory for catalog items not identified.

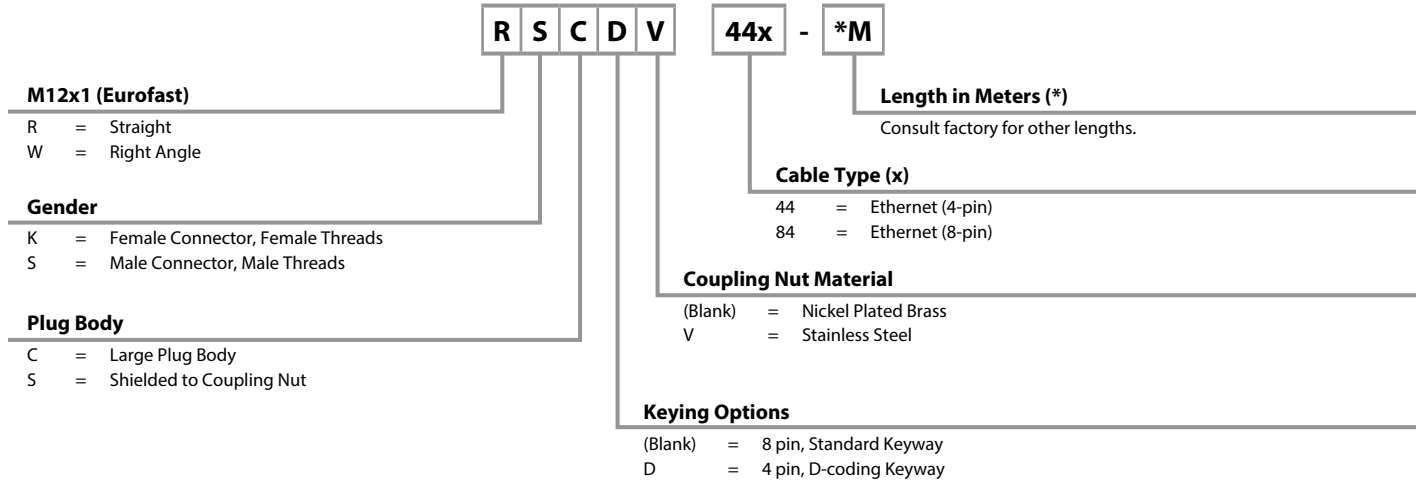

## RJ45 Network Cordsets Part Number Key

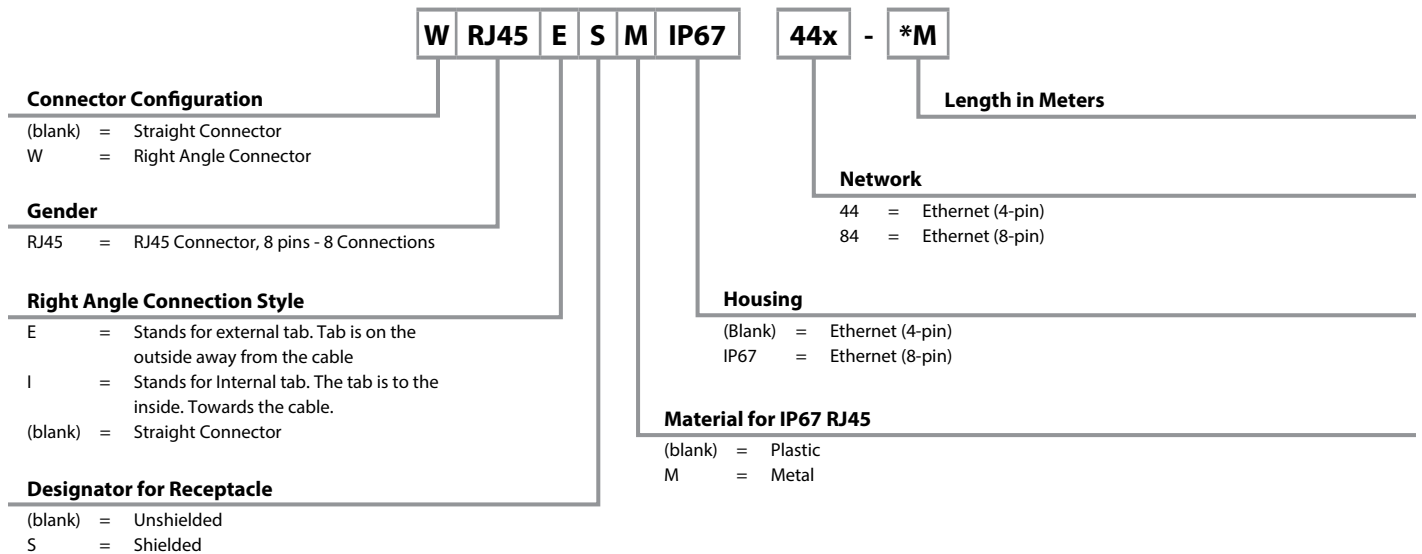

# Ethernet Physical Media Connectivity

## Eurofast® Receptacle Part Number Key

Part Number Keys are to assist in IDENTIFICATION ONLY. Consult factory for catalog items not identified.

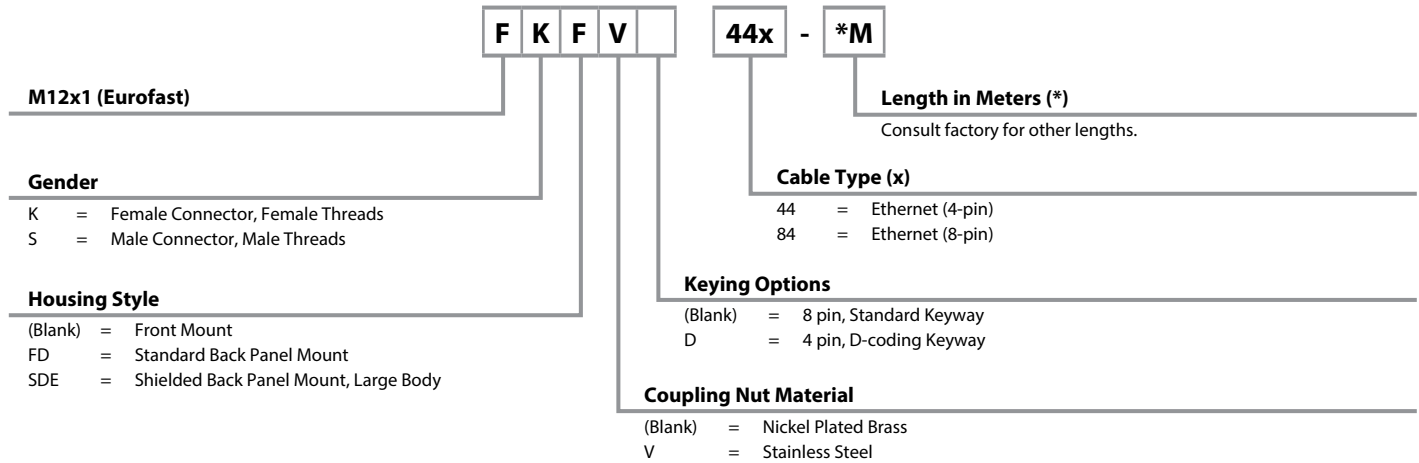



## Ethernet, Cable Specifications, 8-wire

- Cable that meets the requirements of TIA/EIA568-C.2 Category 5e Cable for 10 and 100 Base-T Ethernet
- Cable is UL Rated for Sunlight and Oil Resistant

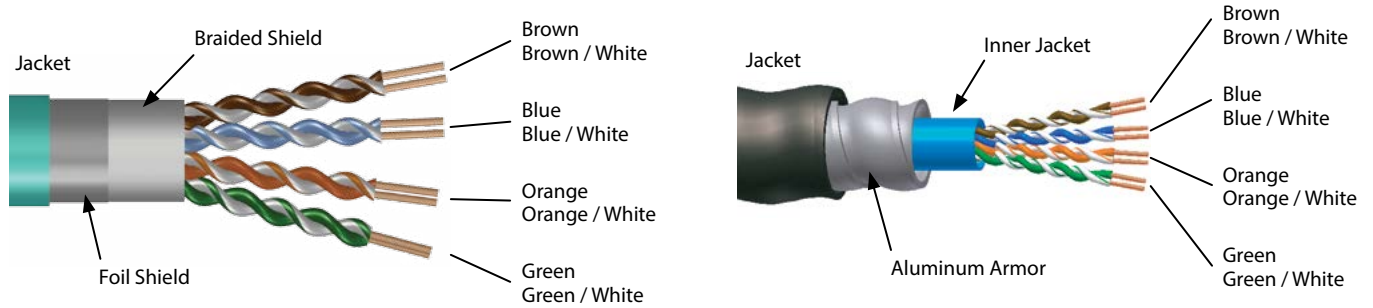

We reserve the right to make technical alterations without prior notice.

| Type                                   | Approvals              | Data Pair               |                                | Outer Jacket<br>Material Color<br>Nominal O.D. | Shields<br>Type     | Bulk Cable<br>Part Number /<br>Weight/300 M | Flexlife Ratings                                      |
|--|------------------------|-------------------------|--------------------------------|--|---------------------|---|---|
|  |                        | AWG<br>Color Code       | DCR (/1000 feet)<br>Insulation |  |                     |   |   |
| <b>840</b><br>80 °C, 600 V             | c(UL)us Type CM<br>AWM | 4UTPx24 AWG<br>Stranded | 26.5 Ohms<br>PE                | TPE Teal<br>6.3 mm (.118 in)                   | -                   | RB51460-*M<br>29 lbs.<br>Flexlife®          | 10xO.D. 1 million cycles<br>20xO.D. 10 million cycles |
| <b>841</b><br>80 °C, 600 V             | c(UL)us Type CM<br>AWM | 4UTPx24 AWG<br>Stranded | 26.5 Ohms<br>PE                | TPE Teal<br>7.7 mm (.303 in)                   | Foil/Braid          | RB50893-*M<br>43 lbs.<br>Flexlife           | 10xO.D. 1 million cycles<br>20xO.D. 10 million cycles |
| <b>842</b><br>75 °C, 300 V             | c(UL)us Type CM<br>AWM | 4UTPx24 AWG<br>Solid    | 31.5 Ohms<br>PE                | TPE Teal<br>6.1 mm (.240 in)                   | -                   | RB51462-*M<br>26 lbs.                       | -   |
| <b>843</b><br>80 °C, 600 V             | c(UL)us Type CM<br>AWM | 4UTPx24 AWG<br>Solid    | 28.6 Ohms<br>PE                | TPE Teal<br>7.3 mm (.287 in)                   | Foil/Braid          | RB51463-*M<br>41 lbs.                       | -   |
| <b>849A</b><br>AWM 444<br>75 °C, 300 V | NEC CM<br>IAA CMG, FT4 | 4UTPx24 AWG<br>Solid    | 27.5 Ohms<br>PO                | PVC Black<br>14.1 mm (.555 in)                 | Foil/Braid<br>Armor | RB51100-*M<br>100 lbs.<br>Armorfast®        | -   |

\* Indicates length in meters.







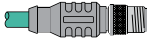
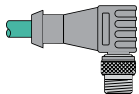

Standard spool lengths are 30, 75, 100, 150, 200, 225, 300 meters. Consult factory for other lengths.

†† 1 million cycles at 1.5" bend radius.

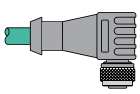
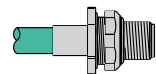
††† 2 million cycles at 2.5" bend radius.

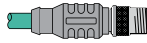
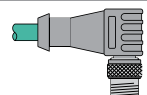
# Ethernet Physical Media Connectivity

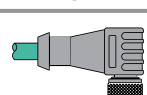
## Ethernet, (M12x1) Eurofast®, RJ45, Cable/Cordset Selection Matrix - Unshielded

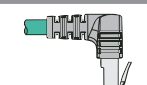
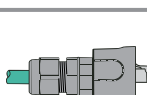
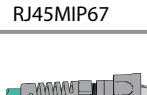
|   |                 | Eurofast   |   |   |   |   |                       |
|---|-----------------|--|---|---|---|---|-----------------------|
|   |                 | Male   |   | Female  |   | Male  |                       |
|   |                 | 1     | 2  | 3  | 4  | 5  |                       |
|   |                 | RSC  | WSC   | RKC   | WKC   | FSFD  |                       |
|  |                 | Bare   | RSC 84x-*M  | WSC 84x-*M  | RKC 84x-*M  | WKC 84x-*M  | FSFD 84x-*M           |
| Eurofast  | Male            | 1     | RSC RSC 84x-*M  | RSC WSC 84x-*M  | RSC RKC 84x-*M  | RSC WKC 84x-*M  | RSC FSFD 84x-*M       |
|   |                 | 2     | WSC RSC 84x-*M  | WSC WSC 84x-*M  | WSC RKC 84x-*M  | WSC WKC 84x-*M  | WSC FSFD 84x-*M       |
|   | Female          | 3     |   |   | RKC RKC 84x-*M  |   | RKC FSFD 84x-*M       |
|   |                 | 4     |   |   | RKC WKC 84x-*M  | WKC WKC 84x-*M  | WKC FSFD 84x-*M       |
| RJ45  | RJ45 Plug       | 9   |   |   |   |   | RJ45 FSFD 84x-*M      |
|   | WRJ45 Plug      | 10  |   |   |   |   | WRJ45E FSFD 84x-*M    |
|   | RJ45M IP67 Plug | 11  |   |   |   |   | RJ45MIP67 FSFD 84x-*M |
|   | RJ45 IP67 Plug  | 12  |   |   |   |   | RJ45IP67 FSFD 84x-*M  |



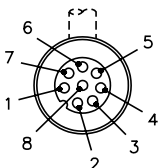
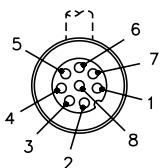

We reserve the right to make technical alterations without prior notice.

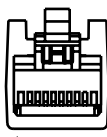
See pages K10 - K11 for dimensional drawings.

| Eurofast  | Pinouts  | Eurofast  |
|---|--|---|
| Male  | 1. White/Blue<br>2. White/Brown<br>3. Brown<br>4. Orange<br>5. White/Green<br>6. White/Orange<br>7. Blue<br>8. Green | Female  |
|  |  |  |

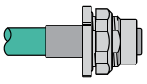
| Standard Pinout  | RJ45 Plug   | (CR) Pinout  |
|--|---|--|
| 1. White/Orange<br>2. Orange<br>3. White/Green<br>4. Blue<br>5. White/Blue<br>6. Green<br>7. White/Brown<br>8. Brown | Male<br><br>12345678 | 1. White/Green<br>2. Green<br>3. White/Orange<br>4. Blue<br>5. White/Blue<br>6. Orange<br>7. White/Brown<br>8. Brown |

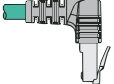
## Ethernet, (M12x1) Eurofast®, RJ45, Cable/Cordset Selection Matrix - Unshielded

| Eurofast   | RJ45   |   |   |   |
|--|--|---|---|---|
| Female   | RJ45 Plug  | WRJ45 Plug  | RJ45M IP67 Plug   | RJ45 IP67 Plug  |
| <b>6</b> <br>FKFD | <b>9</b> <br>RJ45 | <b>10</b> <br>WRJ45E | <b>11</b> <br>RJ45MIP67 | <b>12</b> <br>RJ45IP67 |
| FKFD 84x-*M  | RJ45 84x-*M  | WRJ45E 84x-*M   | RJ45MIP67 84x-*M  | RJ45IP67 84x-*M   |
| RSC FKFD 84x-*M  | RSC RJ45 84x-*M  | RSC WRJ45E 84x-*M   | RSC RJ45MIP67 84x-*M  | RSC RJ45IP67 84x-*M   |
| WSC FKFD 84x-*M  | WSC RJ45 84x-*M  | WSC WRJ45E 84x-*M   | WSC RJ45MIP67 84x-*M  | WSC RJ45IP67 84x-*M   |
| RKC FKFD 84x-*M  | RKC RJ45 84x-*M  | RKC WRJ45E 84x-*M   | RKC RJ45MIP67 84x-*M  | RKC RJ45IP67 84x-*M   |
| WKC FKFD 84x-*M  | WKC RJ45 84x-*M  | WKC WRJ45E 84x-*M   | WKC RJ45MIP67 84x-*M  | WKC RJ45IP67 84x-*M   |
| RJ45 FKFD 84x-*M   | RJ45 RJ45 84x-*M   |   | RJ45 RJ45MIP67 84x-*M   | RJ45 RJ45IP67 84x-*M  |
| WRJ45E FKFD 84x-*M   | WRJ45E RJ45 84x-*M   | WRJ45E WRJ45E 84x-*M  | WRJ45 RJ45MIP67 84x-*M  | WRJ45E RJ45IP67 84x-*M  |
| RJ45MIP67 FKFD 84x-*M  |  |   | RJ45MIP67 RJ45MIP67 84x-*M  | RJ45MIP67 RJ45IP67 84x-*M   |
| RJ45IP67 FKFD 84x-*M   |  |   | RJ45IP67 RJ45MIP67 84x-*M   | RJ45IP67 RJ45IP67 84x-*M  |

See pages K10 - K11 for dimensional drawings.

\* Indicates length in meters.

x Indicates cable type.

Standard cable lengths are 1, 2, 4, 6, 8, 10, 15, and in +5 meter increments from there. Consult factory for other lengths.

For stainless steel coupling nuts change part number RSC ... to RSCV, FKFD ... to FKFDV.

For cross-over cable, add "CR" to part number RJ45 RJ45 CR 84x-\*M.





For right angle RJ45, select WRJ45I for internal tab or WRJ45E for external tab.

We reserve the right to make technical alterations without prior notice.

Ethernet Media

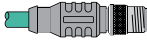
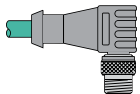
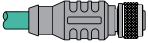
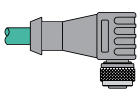
# Ethernet Physical Media Connectivity

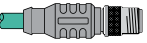
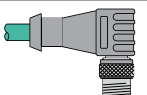
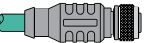
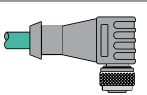
## Ethernet, (M12x1) Eurofast®, RJ45, Cable/Cordset Selection Matrix - Shielded

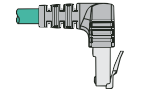
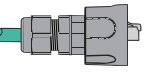
|   |                 | Eurofast   |   |   |   |                |
|---|-----------------|--|---|---|---|----------------|
|   |                 | Male   |   | Female  |   |                |
|   |                 | <br>1<br>RSS          | <br>2<br>WSS | <br>3<br>RKS | <br>4<br>WKS |                |
| <br>Bare |                 | RSS 84x-*M   | WSS 84x-*M  | RKS 84x-*M  | WKS 84x-*M  |                |
| Eurofast  | Male            | <br>1<br>RSS          | RSS RSS 84x-*M  | RSS WSS 84x-*M  | RSS RKS 84x-*M  | RSS WKS 84x-*M |
|   |                 | <br>2<br>WSS          | WSS RSS 84x-*M  | WSS WSS 84x-*M  | WSS RKS 84x-*M  | WSS WKS 84x-*M |
|   | Female          | <br>3<br>RKS          |   |   | RKS RKS 84x-*M  |                |
|   |                 | <br>4<br>WKS         |   |   | WKS RKS 84x-*M  | WKS WKS 84x-*M |
| RJ45  | RJ45 Plug       | <br>9<br>RJ45S      |   |   |   |                |
|   | WRJ45 Plug      | <br>10<br>WRJ45ES   |   |   |   |                |
|   | RJ45M IP67 Plug | <br>11<br>RJ45MIP67 |   |   |   |                |



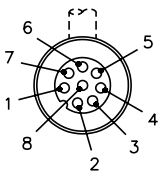
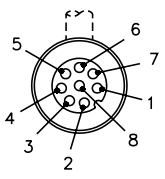

We reserve the right to make technical alterations without prior notice.

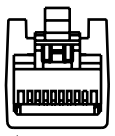
See pages K10 - K11 for dimensional drawings.

| Eurofast  | Pinouts  | Eurofast  |
|---|--|---|
| Male  | 1. White/Blue<br>2. White/Brown<br>3. Brown<br>4. Orange<br>5. White/Green<br>6. White/Orange<br>7. Blue<br>8. Green | Female  |
|  |  |  |

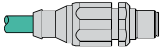
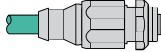
| Standard Pinout  | RJ45 Plug  | (CR) Pinout  |
|--|--|--|
| 1. White/Orange<br>2. Orange<br>3. White/Green<br>4. Blue<br>5. White/Blue<br>6. Green<br>7. White/Brown<br>8. Brown | Male<br><br><b>12345678</b> | 1. White/Green<br>2. Green<br>3. White/Orange<br>4. Blue<br>5. White/Blue<br>6. Orange<br>7. White/Brown<br>8. Brown |

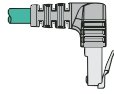
## Ethernet, (M12x1) Eurofast®, RJ45, Cable/Cordset Selection Matrix - Shielded

| Eurofast  |   | RJ45  |   |   |
|---|---|---|---|---|
| Male  | Female  | RJ45 Plug   | WRJ45 Plug  | RJ45M IP67 Plug   |
| <b>7</b> <br>FSSDE | <b>8</b> <br>FKSDE | <b>9</b> <br>RJ45S | <b>10</b> <br>WRJ45ES | <b>11</b> <br>RJ45SMIP67 |
| FSSDE 84x-*M  | FKSDE 84x-*M  | RJ45S 84x-*M  | WRJ45ES 84x-*M  | RJ45SMIP67 84x-*M   |
| RSS FSSDE 84x-*M  | RSS FKSDE 84x-*M  | RSS RJ45S 84x-*M  | RSS WRJ45ES 84x-*M  | RSS RJ45SMIP67 84x-*M   |
| WSS FSSDE 84x-*M  | WSS FKSDE 84x-*M  | WSS RJ45S 84x-*M  | WRJ45ES 84x-*M  | WSS RJ45SMIP67 84x-*M   |
| RKSS FSSDE 84x-*M   | RKS FKSDE 84x-*M  | RKS RJ45S 84x-*M  | RKS WRJ45ES 84x-*M  | RKS RJ45SMIP67 84x-*M   |
| WKS FSSDE 84x-*M  | WKS FKSDE 84x-*M  | WKS RJ45S 84x-*M  | WKS WRJ45ES 84x-*M  | WKS RJ45SMIP67 84x-*M   |
| RJ45S FSSDE 84x-*M  | RJ45S FKSDE 84x-*M  | RJ45S RJ45S 84x-*M  |   | RJ45SS RJ45SMIP67 84x-*M  |
| WRJ45 FSSDE 84x-*M  | WRJ45 FKSDE 84x-*M  | WRJ45ES RJ45S 84x-*M  | WRJ45ES WRJ45ES 84x-*M  | WRJ45ES RJ45SMIP67 84x-*M   |
| RJ45SMIP67 FSSDE 84x-*M   | RJ45SMIP67 FKSDE 84x-*M   |   |   | RJ45SMIP67 RJ45SMIP67 84x-*M  |

See pages K10 - K11 for dimensional drawings.

\* Indicates length in meters.

x Indicates cable type.

Standard cable lengths are 1, 2, 4, 6, 8, 10, 15, and in +5 meter increments from there. Consult factory for other lengths.

For stainless steel coupling nuts change part number RSS ... to RSSV, FKSDE ... to FKSDEV.

For cross-over cable, add "CR" to part number RJ45S RJ45S CR 84x-\*M.

For right angle RJ45, select WRJ45I for internal tab or WRJ45E for external tab.

We reserve the right to make technical alterations without prior notice.

Ethernet Media

# Ethernet Physical Media Connectivity

## Ethernet, Eurofast® Cordset Connector Dimensions / Configuration

### Specifications

|                         |                                       |                             |                                     |
|-------------------------|---------------------------------------|-----------------------------|-------------------------------------|
| <b>Overmold:</b>        | TPU                                   | <b>Protection:</b>          | NEMA 1, 3, 4, 6P and IEC IP 67      |
| <b>Coupling Nut:</b>    | Nickel Plated CuZn or Stainless Steel | <b>Rated Voltage:</b>       | 60 V                                |
| <b>Contact Carrier:</b> | TPU or POM (Nylon)                    | <b>Rated Current:</b>       | 2 A                                 |
| <b>Contacts:</b>        | Gold Plated CuZn                      | <b>Ambient Temperature:</b> | -40 °C to +80 °C (32 °F to +176 °F) |

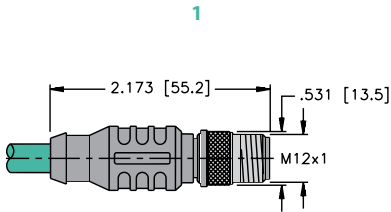

RSC/RSS ..

Page K6

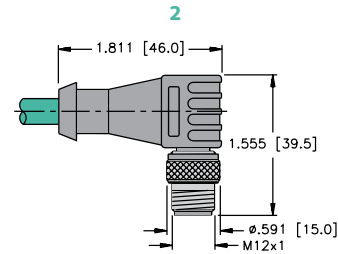

WSC/WSS ..

Page K6

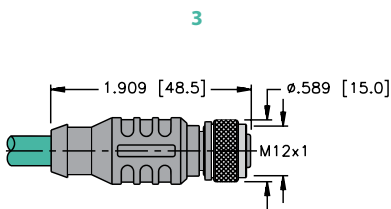

RKC/RKS ..

Page K6

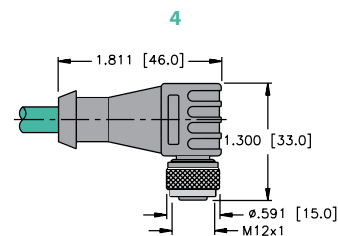

WKC/WKS ..

Page K6

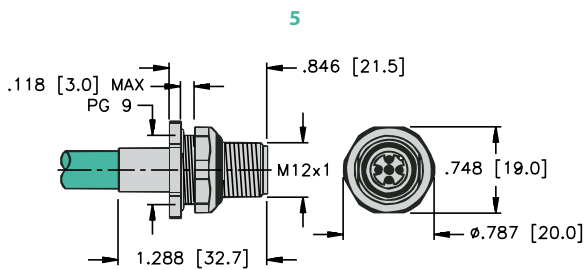

FSFD ..

Page K6

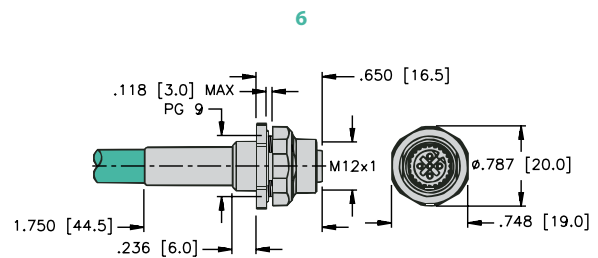

FKFD ..

Page K7

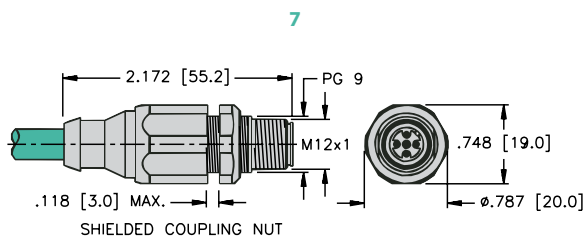

FSSDE ..

Page K9

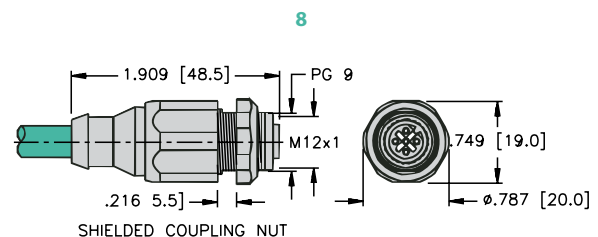

FKSDE ..

Page K9

We reserve the right to make technical alterations without prior notice.

### Specifications

**Overmold:** TPU  
**Coupling Nut:** Nickel Plated CuZn or Stainless Steel  
**Contact Carrier:** TPU or POM (Nylon)  
**Contacts:** Gold Plated CuZn

**Protection:** NEMA 1, 3, 4, 6P and IEC IP 67  
**Rated Voltage:** 60 V  
**Rated Current:** 2 A  
**Ambient Temperature:** -40 °C to +75 °C (-22 °F to +167 °F)

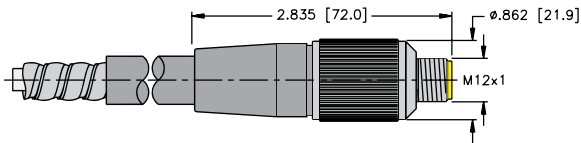

RSA ..

(Armorfast® only)

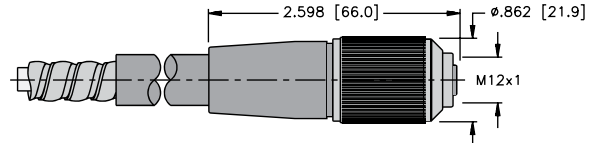

RKA ..

(Armorfast only)

### Specifications

**Overmold:** TPU  
**Plug Material:** Polycarbonate  
**Protection:** NEMA 1 and IEC IP 20

**Rated Voltage:** 42 V  
**Rated Current:** 1.5 A

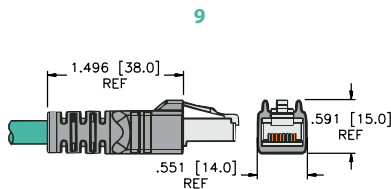

RJ45/RJ45S ..

Page K6

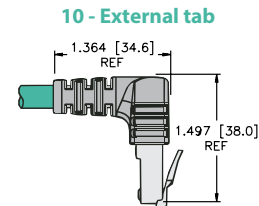

WRJ45E/WRJ45ES ..

External tab

Page K6

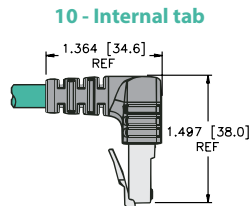

WRJ45I/WRJ45IS ..

Internal tab

Page K6

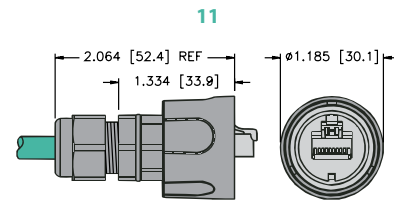

RJ45MIP67/RJ45SMIP67..

Page K6

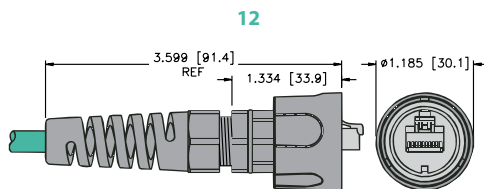

RJ45IP67 ..

Page K6

We reserve the right to make technical alterations without prior notice.

Ethernet Media

# Ethernet Physical Media Connectivity

## Ethernet, Economy RJ45 to RJ45 Cordsets

- For "In the Panel" applications where Industrial Cordsets are not needed
- Available in Yellow, 3 ft and 7 ft lengths only



| Housing | Part Number            | Application  | End View                           | Pinout   |
|---------|------------------------|--|------------------------------------|--|
|         | RJ45 RJ45 840-3FT/ECON | <ul style="list-style-type: none"> <li>• Ethernet patch cordsets for panel connections</li> <li>• Economy, non industrial</li> </ul> | <p><b>Male</b></p> <p>12345678</p> | <ol style="list-style-type: none"> <li>1. WH/OG</li> <li>2. OG</li> <li>3. WH/GN</li> <li>4. BU</li> <li>5. WH/BU</li> <li>6. GN</li> <li>7. WH/BN</li> <li>8. BN</li> </ol> |
|         | RJ45 RJ45 840-7FT/ECON |  |                                    |  |

We reserve the right to make technical alterations without prior notice.



## Ethernet, Circuit Board Connectors and OEM Receptacles, 8-wire

- Provides (M12x1) Eurofast® 8-Pin Connection to Field Devices



| Housing                     | Female Part Number          | Male Part Number            | Features  | Pinout               |
|-----------------------------|-----------------------------|-----------------------------|---|----------------------|
| <p><b>FK 84 PCB KIT</b></p> | <p><b>FK 84-PCB KIT</b></p> | <p><b>FS 84-PCB KIT</b></p> | <p>Nickel plated CuZn or stainless steel, 36 VDC, 1.5 A, -40 °C to +80 °C, Eurofast with mounting kit</p> | <p><b>Female</b></p> |
| <p><b>FS 84 PCB KIT</b></p> |                             |                             |   | <p><b>Male</b></p>   |
| <p><b>FK 84 PCB</b></p>     | <p><b>FK 84-PCB</b></p>     |                             | <p>Nickel plated CuZn or stainless steel, 36 VDC, 1.5 A, -40 °C to +80 °C, Eurofast</p>                   |                      |

We reserve the right to make technical alterations without prior notice.

Standard housing material is nickel plated brass "FSV .."; "FKV ..." indicates 316 stainless steel.

Panel Cutout  
FK ... FS

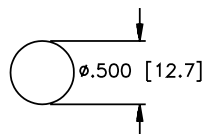

Panel Cutout  
FKFD ... FSFD

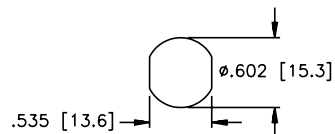

# Ethernet Physical Media Connectivity

## Ethernet, Circuit Board Connectors and OEM Receptacles, 8-wire

- Provides (M12x1) Eurofast® 8-Pin Connection to Field Devices



| Housing               | Female Part Number | Male Part Number   | Features  | Pinout               |
|-----------------------|--------------------|--------------------|---|----------------------|
| <p><b>FKFD..</b></p>  | <b>FKFD 84-PCB</b> | <b>FSFD 84-PCB</b> | Nickel plated CuZn or stainless steel 36 VDC, 1.5 A, -40 °C to +80 °C, Eurofast PCB pins                  | <p><b>Female</b></p> |
| <p><b>FSFD..</b></p>  |                    |                    |   |                      |
| <p><b>FKFDL</b></p>   | <b>FKFDL 84</b>    | <b>FSFDL 84</b>    | Nickel plated CuZn or stainless steel 36 VDC, 1.5 A, -40 °C to +80 °C, male Eurofast solder cups          | <p><b>Male</b></p>   |
| <p><b>FSFDL..</b></p> |                    |                    |   |                      |
| <p><b>WFS..</b></p>   |                    | <b>WFS 84-PCB</b>  | Nickel plated CuZn or stainless steel 36 VDC, 1.5 A, -40 °C to +80 °C, male Eurofast right angle PCB pins |                      |

We reserve the right to make technical alterations without prior notice.

Standard housing material is nickel plated brass "FKFD.."; "FKFDV.." indicates 316 stainless steel.

Panel Cutout  
FKFD ... FSFD

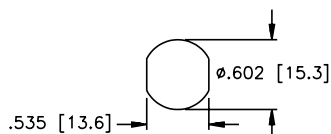

Panel Cutout  
WFS

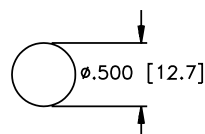

## Ethernet, Cable Specifications, 4-wire

- Cable that meets the requirements of TIA/EIA568-C Category 5e performance requirements cable for 10 and 100 Base-T Ethernet
- Compliant with EtherNet/IP standards
- Cable is UL Rated for Sunlight and Oil Resistant

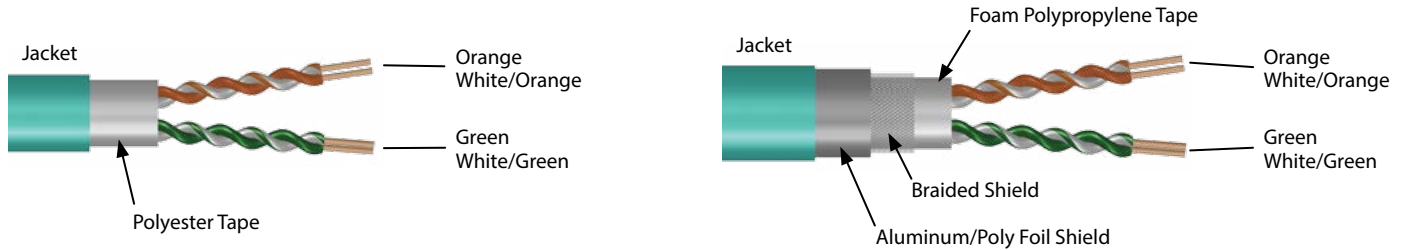

Maximum 100 meters of cable of which:

- 90 meters Horizontal Cable (SOLID - 442 or 443)
- 2 x 5 meters Patch Cables (STRANDED - 440 or 441)





We reserve the right to make technical alterations without prior notice.

| Type                       | Approvals              | Data Pair               |                                | Outer Jacket<br>Material Color<br>Nominal O.D. | Shields<br>Type | Bulk Cable<br>Part Number /<br>Weight/300 M | Flexlife Ratings                                      |
|----------------------------|------------------------|-------------------------|--------------------------------|--|-----------------|---|---|
|                            |                        | AWG<br>Color Code       | DCR (/1000 feet)<br>Insulation |  |                 |   |   |
| <b>440</b><br>80 °C, 600 V | c(UL)us Type CM<br>AWM | 2UTPx24 AWG<br>Stranded | 26.5 Ohms<br>PE                | TPE Teal<br>6.1 mm (.240 in)                   | -               | RB51210-*M<br>26 lbs.<br>Flexlife®          | 10xO.D. 1 million cycles<br>20xO.D. 10 million cycles |
| <b>441</b><br>80 °C, 600 V | c(UL)us Type CM<br>AWM | 2UTPx24 AWG<br>Stranded | 26.5 Ohms<br>PE                | TPE Teal<br>6.7 mm (.240 in)                   | Foil/Braid      | RB51211-*M<br>35 lbs.<br>Flexlife           | 10xO.D. 1 million cycles<br>20xO.D. 10 million cycles |
| <b>442</b><br>75 °C, 300 V | c(UL)us Type CM        | 2UTPx24 AWG<br>Solid    | 31.5 Ohms<br>PE                | TPE Teal<br>6.1 mm (.220 in)                   | -               | RB51212-*M<br>18 lbs.                       | -   |
| <b>443</b><br>80 °C, 600 V | c(UL)us Type CM<br>AWM | 2UTPx24 AWG<br>Solid    | 31.5 Ohms<br>PE                | TPE Teal<br>6.9 mm (.270 in)                   | Foil/Braid      | RB51213-*M<br>38 lbs.                       | -   |

\* Indicates length in meters.  
Standard spool lengths are 30, 75, 100, 150, 200, 225, 300 meters. Consult factory for other lengths.

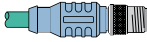
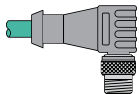
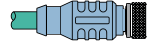
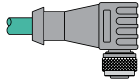
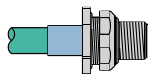
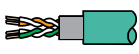
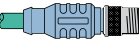
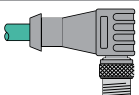
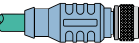
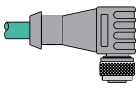
# Ethernet Physical Media Connectivity

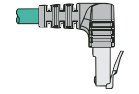
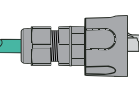

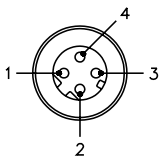
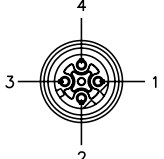

## Ethernet, (M12x1) Eurofast®, RJ45 Cables and Extensions - Unshielded D-coded

|          |  | Eurofast  |   |  |   |   |                        |
|----------|--|---|---|--|---|---|------------------------|
|          |  | Male  |   | Female   |   | Male  |                        |
|          |  |  11<br>RSCD        |  2<br>WSCD |  12<br>RKCD |  4<br>WKCD |  13<br>FSFDD |                        |
|          |  Bare | RSCD 44x-*M   | WSCD 44x-*M   | RKCD 44x-*M  | WKCD 44x-*M   | FSFDD 44x-*M  |                        |
| Eurofast | Male   |  11<br>RSCD        | RSCD RSCD 44x-*M  | RSCD WSCD 44x-*M   | RSCD RKCD 44x-*M  | RSCD WKCD 44x-*M  | RSCD FSFDD 44x-*M      |
|          |  |  2<br>WSCD         | WSCD RSCD 44x-*M  | WSCD WSCD 44x-*M   | WSCD RKCD 44x-*M  | WSCD WKCD 44x-*M  | WSCD FSFDD 44x-*M      |
|          | Female   |  12<br>RKCD        |   | RKCD RKCD 44x-*M   |   |   | RKCD FSFDD 44x-*M      |
|          |  |  4<br>WKCD        |   |  | WKCD RKCD 44x-*M  | WKCD WKCD 44x-*M  | WKCD FSFDD 44x-*M      |
| RJ45     | RJ45 Plug  |  17<br>RJ45      |   |  |   |   | RJ45 FSFDD 44x-*M      |
|          | WRJ45 Plug   |  18<br>WRJ45E    |   |  |   |   | WRJ45E FSFDD 44x-*M    |
|          | RJ45M IP67 Plug  |  19<br>RJ45MIP67 |   |  |   |   | RJ45MIP67 FSFDD 44x-*M |
|          | RJ45 IP67 Plug   |  20<br>RJ45IP67  |   |  |   |   | RJ45IP67 FSFDD 44x-*M  |

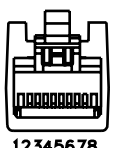
We reserve the right to make technical alterations without prior notice.

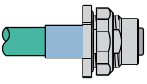
| Eurofast  | Pinouts   | Eurofast  |
|---|---|---|
| Male  |   | Female  |
|  | 1. White/Orange (+ tx)<br>2. White/Green (+rx)<br>3. Orange (-tx)<br>4. Green (-rx) |  |

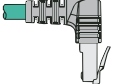
| RJ45 Pinout  | RJ45 Plug   | RJ45 (CR) Pinout   |
|--|---|--|
| 1. White/Orange<br>2. Orange<br>3. White/Green<br>4. N/C<br>5. N/C<br>6. Green<br>7. N/C<br>8. N/C | Male<br><br>12345678 | 1. White/Green<br>2. Green<br>3. White/Orange<br>4. N/C<br>5. N/C<br>6. Orange<br>7. N/C<br>8. N/C |

| Eurofast   | RJ45  |   |   |   |
|--|---|---|---|---|
| Female   | RJ45 Plug   | WRJ45 Plug  | RJ45M IP67 Plug   | RJ45 IP67 Plug  |
| <br>14<br>FKFDD | <br>17<br>RJ45 | <br>18<br>WRJ45E | <br>19<br>RJ45MIP67 | <br>20<br>RJ45IP67 |
| FKFDD 44x-*M   | RJ45 44x-*M   | WRJ45E 44x-*M   | RJ45MIP67 44x-*M  | RJ45IP67 44x-*M   |
| RSCD FKFDD 44x-*M  | RSCD RJ45 44x-*M  | RSCD WRJ45E 44x-*M  | RSCD RJ45MIP67 44x-*M   | RSCD RJ45IP67 44x-*M  |
| WSCD FKFDD 44x-*M  | WSCD RJ45 44x-*M  | WSCD WRJ45E 44x-*M  | WSCD RJ45MIP67 44x-*M   | WSCD RJ45IP67 44x-*M  |
| RKCD FKFDD 44x-*M  | RKCD RJ45 44x-*M  | RKCD WRJ45E 44x-*M  | RKCD RJ45MIP67 44x-*M   | RKCD RJ45IP67 44x-*M  |
| WKCD FKFDD 44x-*M  | WKCD RJ45 44x-*M  | WKCD WRJ45E 44x-*M  | WKCD RJ45MIP67 44x-*M   | WKCD RJ45IP67 44x-*M  |
| RJ45 FKFDD 44x-*M  | RJ45 RJ45 44x-*M  |   | RJ45 RJ45MIP67 44x-*M   | RJ45 RJ45IP67 44x-*M  |
| WRJ45E FKFDD 44x-*M  | WRJ45E RJ45 44x-*M  | WRJ45E WRJ45E 44x-*M  | WRJ45E RJ45MIP67 44x-*M   | WRJ45E RJ45IP67 44x-*M  |
| RJ45MIP67 FKFDD 44x-*M   |   |   | RJ45MIP67 RJ45MIP67 44x-*M  |   |
| RJ45IP67 FKFDD 44x-*M  |   |   | RJ45IP67 RJ45MIP67 44x-*M   | RJ45IP67 RJ45IP67 44x-*M  |

We reserve the right to make technical alterations without prior notice.

Ethernet Media

See pages K20 - K21 for dimensional drawings.

\* Indicates length in meters.







x Indicates cable type.

Standard cable lengths are 1, 2, 4, 6, 8, 10, 15, and in +5 meter increments from there. Consult factory for other lengths.

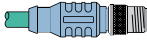
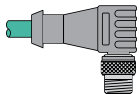
For right angle RJ45, select WRJ45I for internal tab or WRJ45E for external tab.

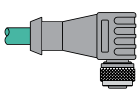
# Ethernet Physical Media Connectivity

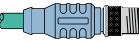
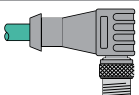
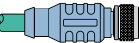
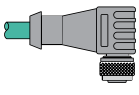

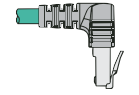
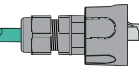

## Ethernet, (M12x1) Eurofast®, RJ45, Cables and Extensions - Shielded Cable D-coded

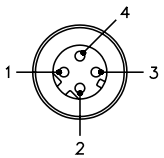
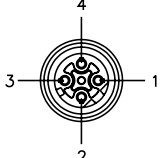
|   |        | Eurofast   |   |  |   |                  |
|---|--------|--|---|--|---|------------------|
|   |        | Male   |   | Female   |   |                  |
| Eurofast  | Male   | 11            | 2  | 12  | 4  |                  |
|   |        | RSSD   | WSSD  | RKSD   | WKSD  |                  |
|   | Female | Bare          | RSSD 44x-*M   | WSSD 44x-*M  | RKSD 44x-*M   | WKSD 44x-*M      |
|   |        | 11            | RSSD RSSD 44x-*M  | RSSD WSSD 44x-*M   | RSSD RKSD 44x-*M  | RSSD WKSD 44x-*M |
|   | Male   | 2             | WSSD RSSD 44x-*M  | WKSD WSSD 44x-*M   | WSSD RKSD 44x-*M  | WSSD WKSD 44x-*M |
|   |        | 12            |   |  | RKSD RKSD 44x-*M  |                  |
|   | Female | 4            |   |  | RKSD WKSD 44x-*M  | WKSD WKSD 44x-*M |
|   |        | RJ45 Plug   |   |  |   |                  |
|   | RJ45   | 17   | RJ45S   |  |   |                  |
|   |        | WRJ45 Plug  | 18  | WRJ45ES  |   |                  |
| RJ45M IP67 Plug  |        | 19   | RJ45MIP67   |  |   |                  |

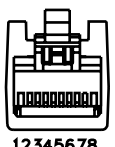
We reserve the right to make technical alterations without prior notice.

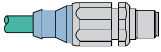
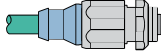
| Eurofast  | Pinouts   | Eurofast  |
|---|---|---|
| Male  |   | Female  |
|  | 1. White/Orange (+ tx)<br>2. White/Green (+rx)<br>3. Orange (-tx)<br>4. Green (-rx) |  |

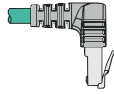
| RJ45 Pinout  | RJ45 Plug   | RJ45 (CR) Pinout   |
|--|---|--|
| 1. White/Orange<br>2. Orange<br>3. White/Green<br>4. N/C<br>5. N/C<br>6. Green<br>7. N/C<br>8. N/C | Male<br><br>12345678 | 1. White/Green<br>2. Green<br>3. White/Orange<br>4. N/C<br>5. N/C<br>6. Orange<br>7. N/C<br>8. N/C |

| Eurofast  |   | RJ45   |   |   |
|---|---|--|---|---|
| Male  | Female  | RJ45 Plug  | WRJ45 Plug  | RJ45M IP67 Plug   |
| <br>15<br>FSSDED | <br>16<br>FKSDED | <br>17<br>RJ45S | <br>18<br>WRJ45ES | <br>19<br>RJ45SMIP67 |
| FSSDED 44x-*M   | FKSDED 44x-*M   | RJ45S 44x-*M   | WRJ45ES 44x-*M  | RJ45SMIP67 44x-*M   |
| RSSD FSSDED 44x-*M  | RSSD FKSDED 44x-*M  | RSSD RJ45S 44x-*M  | RSSD WRJ45ES 44x-*M   | RSSD RJ45SMIP67 44x-*M  |
| WSSD FSSDED 44x-*M  | WSSD FKSDED 44x-*M  | WSSD RJ45S 44x-*M  | WSSD WRJ45ES 44x-*M   | WSSD RJ45SMIP67 44x-*M  |
| RKSD FSSDED 44x-*M  | RKSD FKSDED 44x-*M  | RKSD RJ45S 44x-*M  | RKSD WRJ45ES 44x-*M   | RKSD RJ45SMIP67 44x-*M  |
| WKSD FSSDED 44x-*M  | RSSD FKSDED 44x-*M  | WKSD RJ45S 44x-*M  | WKSD WRJ45ES 44x-*M   | WKSD RJ45SMIP67 44x-*M  |
| RJ45S FSSDED 44x-*M   | RJ45S FKSDED 44x-*M   | RJ45S RJ45S 44x-*M   |   | RJ45S RJ45SMIP67 44x-*M   |
| WRJ45ES FSSDED 44x-*M   | WRJ45ES FKSDED 44x-*M   | WRJ45ES RJ45S 44x-*M   | WRJ45ES WRJ45ES 44x-*M  | WRJ45ES RJ45SMIP67 44x-*M   |
| RJ45SMIP67 FSFD 84x-*M  | RJ45SMIP67 FKFD 84x-*M  |  |   | RJ45SMIP67 RJ45SMIP67 44x-*M  |

We reserve the right to make technical alterations without prior notice.

See pages K20 - K21 for dimensional drawings.

\* Indicates length in meters.

x Indicates cable type.

Standard cable lengths are 1, 2, 4, 5, 6, 8, 10, 15, and in +5 meter increments from there. Consult factory for other lengths.

For stainless steel coupling nuts change part number RSSD ... RSSDV, FSSDED ... FSSDEDV.

For right angle RJ45, select WRJ45I for internal tab or WRJ45E for external tab.

### Specifications

|                         |                                       |                             |                                     |
|-------------------------|---------------------------------------|-----------------------------|-------------------------------------|
| <b>Overmold:</b>        | TPU                                   | <b>Protection:</b>          | NEMA 1, 3, 4, 6P and IEC IP 67      |
| <b>Coupling Nut:</b>    | Nickel Plated CuZn or Stainless Steel | <b>Rated Voltage:</b>       | 250 V                               |
| <b>Contact Carrier:</b> | TPU or POM (Nylon)                    | <b>Rated Current:</b>       | 4 A                                 |
| <b>Contacts:</b>        | Gold Plated CuZn                      | <b>Ambient Temperature:</b> | -40 °C to +80 °C (32 °F to +176 °F) |

11

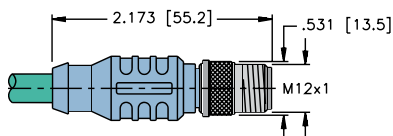

RSCD/RSSD ..

Page K16

12

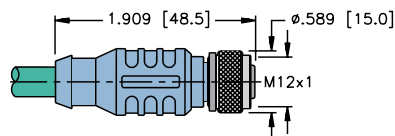

RKCD/RKSD ..

Page K16

13

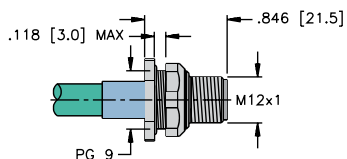

FSFDD ..

Page K16

14

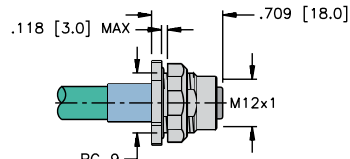

FKFDD ..

Page K17

15

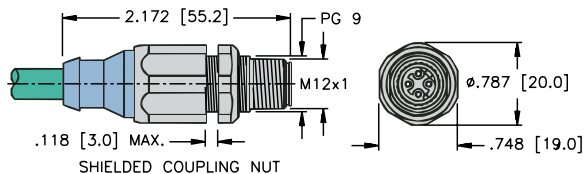

FSSDED ..

Page K19

16

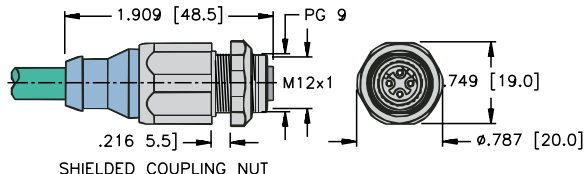

FKSDED ..

Page K19

We reserve the right to make technical alterations without prior notice.



### Specifications

|                       |                    |                             |                                      |
|-----------------------|--------------------|-----------------------------|--------------------------------------|
| <b>Overmold:</b>      | TPU                | <b>Rated Voltage:</b>       | 42 V                                 |
| <b>Plug Material:</b> | Polycarbonate      | <b>Rated Current:</b>       | 1.5 A                                |
| <b>Protection:</b>    | NEMA and IEC IP 20 | <b>Ambient Temperature:</b> | -25 °C to +80 °C (-22 °F to +176 °F) |

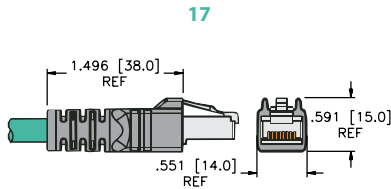

RJ45/RJ45S ..

Page K16

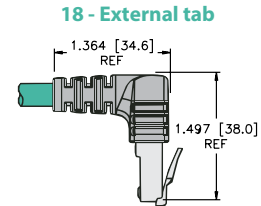

WRJ45E/WRJ45ES ..

External tab

Page K16

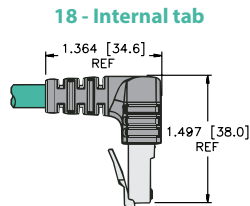

WRJ45I/WRJ45IS ..

Internal tab

Page K16

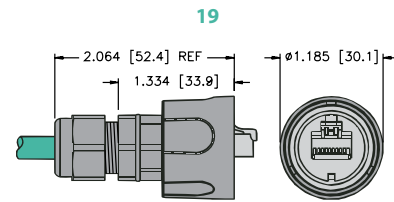

RJ45MIP67/RJ45SMIP67..

Page K16

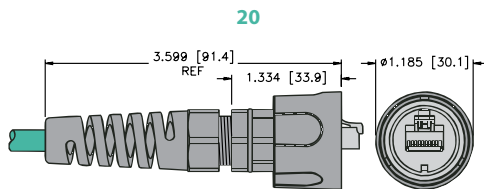

RJ45IP67 ..

Page K16

We reserve the right to make technical alterations without prior notice.

Ethernet Media

# Ethernet Physical Media Connectivity

## Ethernet, Receptacle

- Transitions from a RJ45 Connector to a 4-wire Eurofast® Connector



| Housing Style | Part Number              | Features  |
|---------------|--------------------------|---|
|               | <b>FKSD RJ45SF 44</b>    | Polyurethane, TPU Overmold, 42 V, 1.5 A, -40 °C to +75 °C |
|               | <b>FKSD RJ45SF 44/ST</b> | Polyurethane, TPU Overmold, 42 V, 1.5 A, -40 °C to +75 °C |
|               | <b>FKD FKD 44/M12</b>    | 4 A, 50 V, -25 °C to +85 °C, wired one-to-one             |

We reserve the right to make technical alterations without prior notice.

Panel mounting clearance hole 19/32" (15 mm). Panel thickness: .060-.120" (1.5-3 mm)

### Wiring Diagrams

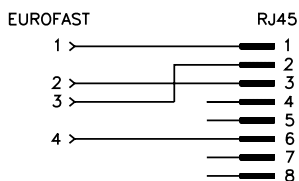

## Ethernet, 4-Pin D-coded Field Wireables

- Allows for Quick Connections when Pre-Molded Cables are not available
- Available in Male, Straight and Right Angle Connector configurations



We reserve the right to make technical alterations without prior notice.

| Housing Style            | Female Part Number | Male Part Number | Features   | Pinout               |
|--------------------------|--------------------|------------------|--|----------------------|
| <p><b>CMBD 81..</b></p>  | CMBD 8141-0/PG9    | CMBSD 8141-0/PG9 | 4 A, 250 V, -40 °C to +85 °C, mates with female 4-pin D-coded Eurofast® cordsets and receptacles | <p><b>Female</b></p> |
| <p><b>CMBSD 81..</b></p> |                    |                  |  |                      |
| <p><b>CMBD 82..</b></p>  | CMBD 8241-0/PG9    | CMBSD 8241-0/PG9 |  | <p><b>Male</b></p>   |
| <p><b>CMBSD 82..</b></p> |                    |                  |  |                      |

Ethernet Media

# Ethernet Physical Media Connectivity

## Ethernet, RJ45 Field Wireable

- Allows for Quick Connections in the field
- Fully Shielded
- Includes assembly instructions



| Housing | Part Number                              | Features   | Pinout          |
|---------|--|--|-----------------|
|         | <b>Connector, RJ45S IDC</b>              | 22-24 AWG stranded, 22-23 AWG solid, -40 °C to +70 °C          | <b>Male</b><br> |
|         | <b>Connector, FW, RJ45S 84 IDC</b>       | 22-27 AWG stranded, 22-24 AWG solid, -40 °C to +85 °C, Cat 6 A | <b>Male</b><br> |
|         | <b>Connector, FW, RJ45S 86 IDC CAT 6</b> | 22-26 AWG, -40 °C to +70 °C, Cat 6 A                           | <b>Male</b><br> |

We reserve the right to make technical alterations without prior notice.

|                             |            |
|-----------------------------|------------|
| <b>Part Number Keys</b>     | <b>L2</b>  |
| <b>Cable Specifications</b> | <b>L3</b>  |
| <b>Cordsets</b>             | <b>L4</b>  |
| <b>Receptacles</b>          | <b>L8</b>  |
| <b>Field Wireables</b>      | <b>L10</b> |

**Features**

- CAT 5e rated cables
- 2 Pair cable option
- 4-pin D-coded M12 connectors
- RJ45 connectors
- Up to 4 Amps and 250 Volt rated
- IP67 rated



# PROFINET Physical Media Connectivity

## Eurofast® Cordset Part Number Key

Part Number Keys are to assist in IDENTIFICATION ONLY. Consult factory for catalog items not identified.

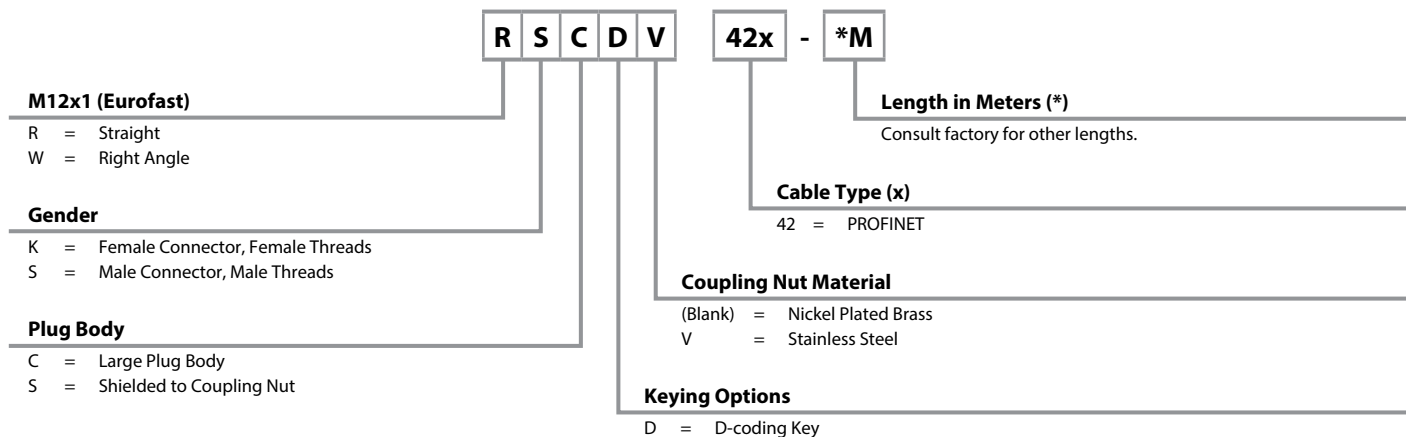

## Eurofast Receptacle Part Number Key

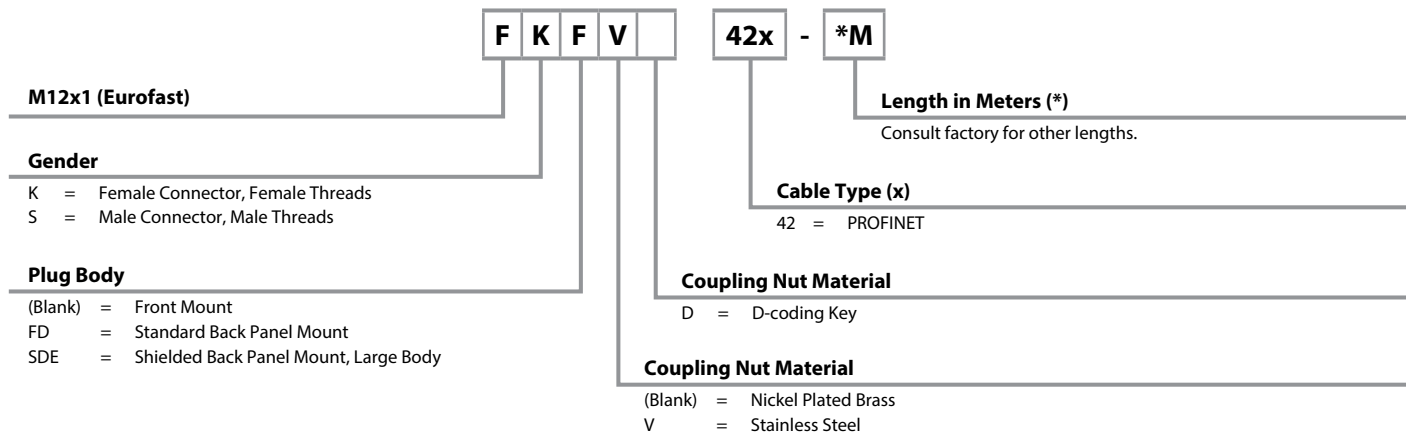

## RJ Network Cordsets Part Number Key

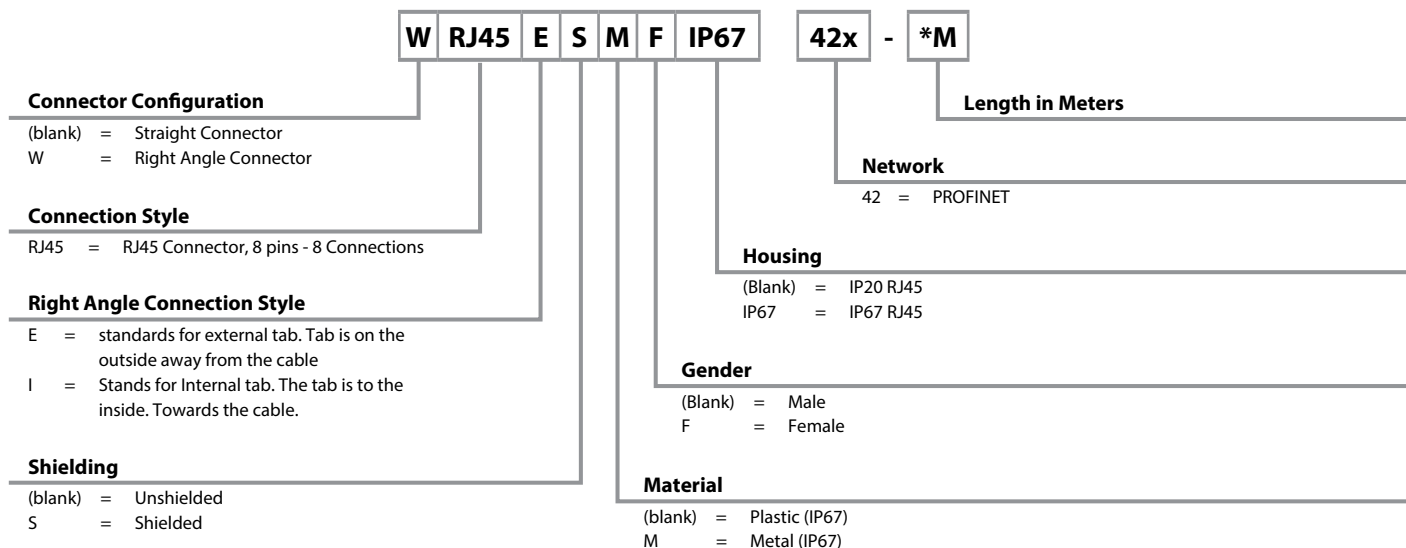

PROFINET, Cable Specifications, 4-wire

- Compliant with PROFINET Cable Standards
- Cable is UL Rated for Sunlight and Oil Resistant

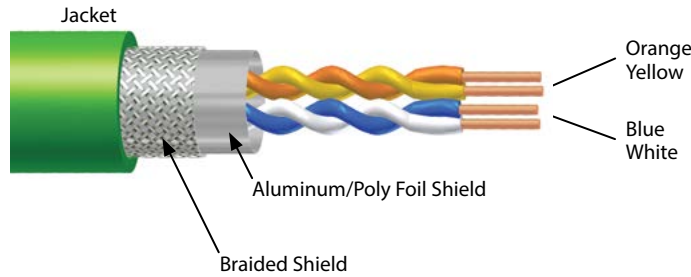

We reserve the right to make technical alterations without prior notice.





PROFINET Media

| Version  | Type                        | Approvals          | Data Pair                  |                                | Outer Jacket<br>Material Color<br>Nominal O.D. | Shields<br>Type | Bulk Cable<br>Part Number /<br>Weight/300 M     |
|--|-----------------------------|--------------------|----------------------------|--------------------------------|--|-----------------|---|
|  |                             |                    | AWG<br>Color Code          | DCR (/1000 feet)<br>Insulation |  |                 |   |
| <b>Type A<br/>Stationary with solid<br/>conductors</b>         | <b>421<br/>80 °C, 600 V</b> | UL ITC/PLTC<br>AWM | 4UTPX22<br>AWG Solid       | 17.2 Ohm                       | TPE/Green<br>7.8 mm                            | Foil/Braid      | RB51604* <sup>M</sup> ,<br>49 lbs.              |
| <b>Type C<br/>Highly flexible with<br/>stranded conductors</b> | <b>423<br/>80 °C, 600 V</b> | UL ITC/PLTC        | 4UTPX22<br>AWG<br>Stranded | 17.5 Ohm                       | TPE/Green<br>8.1 mm                            | Foil/Braid      | RB51216* <sup>M</sup> ,<br>49 lbs.<br>Flexlife® |

\* Indicates length  
Standard spool lengths are 30, 75, 100, 150, 200, 225, 300 meters. Consult factory for other lengths.

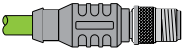
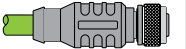
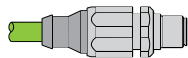
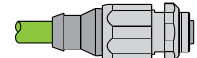
# PROFINET Physical Media Connectivity

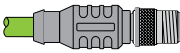
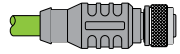
## PROFINET, (M12x1) Eurofast®, RJ45, Cables and Extensions - Shielded Cable D-coded

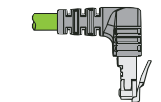
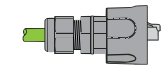
|   |   | Eurofast (Male)   | Eurofast (Female)   | Eurofast (Male)  | Eurofast (Female)   |
|---|---|---|---|--|---|
|   |   | 1 <br>RSSD | 2 <br>RKSD | 3 <br>FSSDED | 4 <br>FKSDED |
| <br>Bare |   | RSSD 42x-*M   | RKSD 42x-*M   | FSSDED 42x-*M  | FKSDED 42x-*M   |
| <b>Eurofast (Male)</b>  | 1 <br>RSSD         | RSSD RSSD 42x-*M  | RSSD RKSD 42x-*M  | RSSD FSSDED 42x-*M   | RSSD FKSDED 42x-*M  |
| <b>Eurofast (Female)</b>  | 2 <br>RKSD         |   | RKSD RKSD 42x-*M  | RKSD FSSDED 42x-*M   | RKSD FKSDED 42x-*M  |
| <b>RJ45 Plug</b>  | 5 <br>RJ45S        |   |   | RJ45S FSSDED 42x-*M  | RJ45S FKSDED 42x-*M   |
| <b>WRJ45 Plug</b>   | 6 <br>WRJ45ES    |   |   | WRJ45ES FSSDED 42x-*M  | WRJ45ES FKSDED 42x-*M   |
| <b>RJ45M IP67 Plug</b>  | 7 <br>RJ45SMIP67 |   |   | RJ45SMIP67 FSSDED 42x-*M   | RJ45SMIP67 FKSDED 42x-*M  |

We reserve the right to make technical alterations without prior notice.

See pages L8 - L9 for dimensional drawings.

\* Indicates length in meters.

x Indicates cable type.

Standard cable lengths are 1, 2, 4, 6, 8, 10, 15, and in +5 meter increments from there. Consult factory for other lengths.

For stainless steel coupling nuts change part number RSSD ... RSSDV, FSSDED ... FSSDEDV.



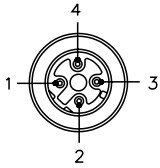
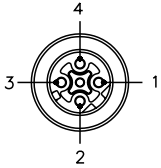

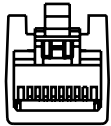

For right angle RJ45, select WRJ45I for internal tab or WRJ45E for external tab.

| Eurofast  | Pinouts   | Eurofast  |
|---|---|---|
| <b>Male</b>   |   | <b>Female</b>   |
|  | 1. Yellow (+tx)<br>2. White (+rx)<br>3. Orange (-tx)<br>4. Blue (-rx) |  |

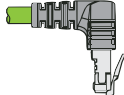
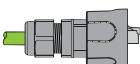
| RJ45 Pinout   | RJ45 Plug   |
|---|---|
| 1. Yellow<br>2. Orange<br>3. White<br>4. N/C<br>5. N/C<br>6. Blue<br>7. N/C<br>8. N/C | <b>Male</b><br><br><b>12345678</b> |

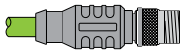
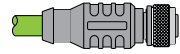

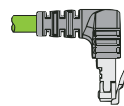
PROFINET, (M12x1) Eurofast®, RJ45, Cables and Extensions - Shielded Cable D-coded

|   |   | RJ45 Plug  | WRJ45 Plug   | RJ45M IP67 Plug   |
|---|---|--|--|---|
|   |   | 5 <br>RJ45S | 6 <br>WRJ45ES | 7 <br>RJ45SMIP67 |
| <br>Bare |   | RJ45S 42x-*M   | WRJ45ES 42x-*M   | RJ45SMIP67 42x-*M   |
| <b>Eurofast (Male)</b>  | 1 <br>RSSD         | RSSD RJ45S 42x-*M  | RSSD WRJ45ES 42x-*M  | RSSD RJ45SMIP67 42x-*M  |
| <b>Eurofast (Female)</b>  | 2 <br>RKSD         | RKSD RJ45S 42x-*M  | RKSD WRJ45ES 42x-*M  | RKSD RJ45SMIP67 42x-*M  |
| <b>RJ45 Plug</b>  | 5 <br>RJ45S        | RJ45S RJ45S 42x-*M   |  | RJ45S RJ45SMIP67 42x-*M   |
| <b>WRJ45 Plug</b>   | 6 <br>WRJ45ES    | WRJ45ES RJ45S 42x-*M   | WRJ45ES WRJ45ES 42x-*M   | WRJ45ES RJ45SMIP67 42x-*M   |
| <b>RJ45M IP67 Plug</b>  | 7 <br>RJ45SMIP67 | RJ45SMIP67 RJ45S 42x-*M  | RJ45SMIP67 WRJ45ES 42x-*M  | RJ45SMIP67 RJ45SMIP67 42x-*M  |

We reserve the right to make technical alterations without prior notice.

PROFINET Media

See pages L8 - L9 for dimensional drawings.

\* Indicates length in meters.

x Indicates cable type.

Standard cable lengths are 1, 2, 4, 6, 8, 10, 15, and in +5 meter increments from there. Consult factory for other lengths.

For stainless steel coupling nuts change part number RSSD ... RSSDV, FSSDED ... FSSDEDV.

For right angle RJ45, select WRJ45I for internal tab or WRJ45E for external tab.

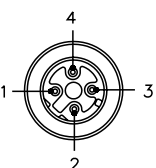
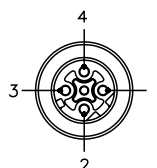
| Eurofast  | Pinouts   | Eurofast  |
|---|---|---|
| <b>Male</b>   |   | <b>Female</b>   |
|  | 1. Yellow (+tx)<br>2. White (+rx)<br>3. Orange (-tx)<br>4. Blue (-rx) |  |

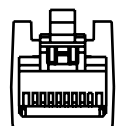
| RJ45 Pinout   | RJ45 Plug  |
|---|--|
| 1. Yellow<br>2. Orange<br>3. White<br>4. N/C<br>5. N/C<br>6. Blue<br>7. N/C<br>8. N/C | <b>Male</b><br><br>12345678 |

### Specifications

|                         |                                       |                             |                                     |
|-------------------------|---------------------------------------|-----------------------------|-------------------------------------|
| <b>Overmold:</b>        | TPU                                   | <b>Protection:</b>          | NEMA 1, 3, 4, 6P and IEC IP 67      |
| <b>Coupling Nut:</b>    | Nickel Plated CuZn or Stainless Steel | <b>Rated Voltage:</b>       | 250 V                               |
| <b>Contact Carrier:</b> | TPU (Polyurethane) or POM (Nylon)     | <b>Rated Current:</b>       | 4 A                                 |
| <b>Contacts:</b>        | Gold Plated CuZn                      | <b>Ambient Temperature:</b> | -40 °C to +80 °C (32 °F to +176 °F) |

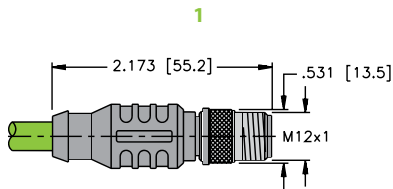

RSCD/RSSD ..

Page L4

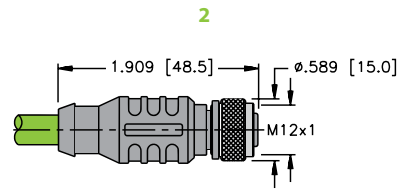

RKCD/RKSD ..

Page L4

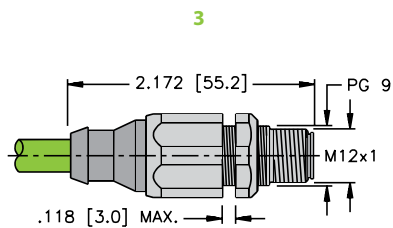

FSSDED ..

Page L4

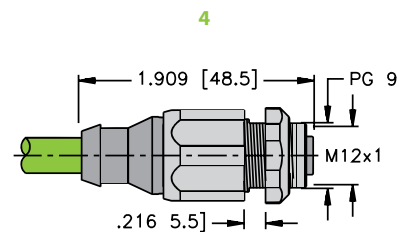

FKSDED ..

Page L4

We reserve the right to make technical alterations without prior notice.

**Specifications**

|                       |                                |                             |                                      |
|-----------------------|--------------------------------|-----------------------------|--------------------------------------|
| <b>Overmold:</b>      | TPU                            | <b>Rated Voltage:</b>       | 42 V                                 |
| <b>Plug Material:</b> | Polycarbonate                  | <b>Rated Current:</b>       | 1.5 A                                |
| <b>Protection:</b>    | NEMA 1 and IEC IP 20 and IP 67 | <b>Ambient Temperature:</b> | -25 °C to +75 °C (-22 °F to +176 °F) |

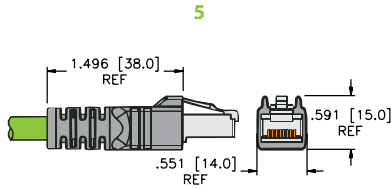

RJ45/RJ45S ..

Page L4

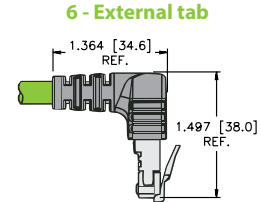

WRJ45E/WRJ45ES ..

External tab

Page L4

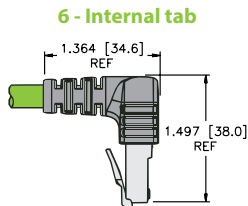

WRJ45I/WRJ45IS ..

Internal tab

Page L4

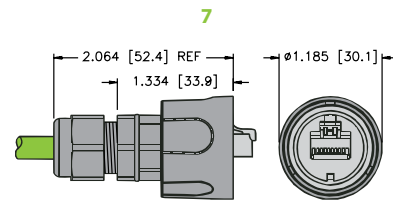

RJ45MIP67/RJ45SMIP67..

Page L4

We reserve the right to make technical alterations without prior notice.

PROFINET Media

# PROFINET Physical Media Connectivity

## PROFINET, Receptacle

- Transitions from a RJ45 Connector to a 4-wire Eurofast® Connector



| Housing Style | Part Number              | Features  |
|---------------|--------------------------|---|
|               | <b>FKSD RJ45SF 44</b>    | Polyurethane, TPU Overmold, 42 V, 1.5 A, -40 °C to +75 °C |
|               | <b>FKSD RJ45SF 44/ST</b> | Polyurethane, TPU Overmold, 42 V, 1.5 A, -40 °C to +75 °C |
|               | <b>FKD FKD 44/M12</b>    | 4 A, 50 V, -25 °C to +85 °C, wired one-to-one             |

We reserve the right to make technical alterations without prior notice.

Panel mounting clearance hole 19/32" (15 mm). Panel thickness: .060-.120" (1.5-3 mm)

### Wiring Diagrams

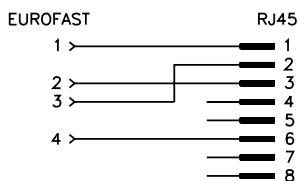

PROFINET, 4-Pin D-coded Field Wireables

- Allows for Quick Connections when Pre-Molded Cables are not available
- Available in Male, Straight and Right Angle Connector configurations



We reserve the right to make technical alterations without prior notice.

| Housing Style            | Female Part Number | Male Part Number | Features   | Pinout               |
|--------------------------|--------------------|------------------|--|----------------------|
| <p><b>CMBD 81..</b></p>  | CMBD 8141-0/PG9    | CMBSD 8141-0/PG9 | 4 A, 250 V, -40 °C to +85 °C, mates with female 4-pin D-coded Eurofast® cordsets and receptacles | <p><b>Female</b></p> |
| <p><b>CMBSD 81..</b></p> |                    |                  |  |                      |
| <p><b>CMBD 82..</b></p>  | CMBD 8241-0/PG9    | CMBSD 8241-0/PG9 |  | <p><b>Male</b></p>   |
| <p><b>CMBSD 82..</b></p> |                    |                  |  |                      |

PROFINET Media

# PROFINET Physical Media Connectivity

## PROFINET, RJ45 Field Wireable

- Allows for Quick Connections in the field
- Fully Shielded
- Includes assembly instructions



| Housing | Part Number                              | Features   | Pinout  |
|---------|--|--|---|
|         | <b>Connector, RJ45S 42 IDC</b>           | 22-26 AWG, -20 °C to 70 °C,<br>6 - 7 mm cable diameter | 1. Yellow (+TX)<br>2. Orange (-TX)<br>3. White (+RX)<br>4. N/C<br>5. N/C<br>6. Blue (-RX)<br>7. N/C<br>8. N/C |
|         | <b>Connector, RJ45S 84 IDC (7- 8 mm)</b> | 22-26 AWG, -20 °C to 70 °C,<br>7 - 8 mm cable diameter |   |

We reserve the right to make technical alterations without prior notice.

|                         |            |
|-------------------------|------------|
| <b>Part Number Keys</b> | <b>M4</b>  |
| <b>Cordsets</b>         | <b>M10</b> |
| <b>Receptacles</b>      | <b>M37</b> |
| <b>Field Wireables</b>  | <b>M46</b> |

**Features**

- Cables that meet the requirements of the ODVA
- PLTC rated cable
- Available in thin, mid, and thick styles
- 7/8 and M12 connectors
- Rated up to 9 Amps and 600 Volts
- IP67/IP69K rated



# DeviceNet™ Physical Media Connectivity

## DeviceNet System Description

DeviceNet is a low-cost communications protocol that eliminates hard wiring and connects industrial devices such as limit switches, photoelectric sensors, valve manifolds, motor starters, process sensors, bar code readers, variable frequency drives, panel displays and operator interfaces to a network. DeviceNet's direct connection provides improved communication between devices, as well as important device-level diagnostics not easily accessible or available through hard-wired I/O interfaces.

DeviceNet is based on the Controller Area Network (CAN) broadcast-oriented communication architecture. CAN uses a bus arbitration method (CSMA/BA) that ensures the highest priority message is given preference in the event of a data collision. The DeviceNet protocol further defines message priorities such that I/O messages are given top priority and configuration messages have lower priority.

A DeviceNet network supports up to 64 nodes and virtually an unlimited amount of I/O. The bus uses a trunkline/dropline topology, where bus power and communication are supplied on a single cable. Bus power is 24 VDC and supplies current to operate the nodes and, typically, the power input devices. Some Turck stations require an additional 24 VDC auxiliary power to supply current for outputs.

DeviceNet allows peer-to-peer data exchange (where a DeviceNet node can initiate communication with other nodes or peers), and a master/slave configuration in which the master node initiates all communication and all other nodes, or slaves, respond to the master node's requests.

## Typical System Configuration

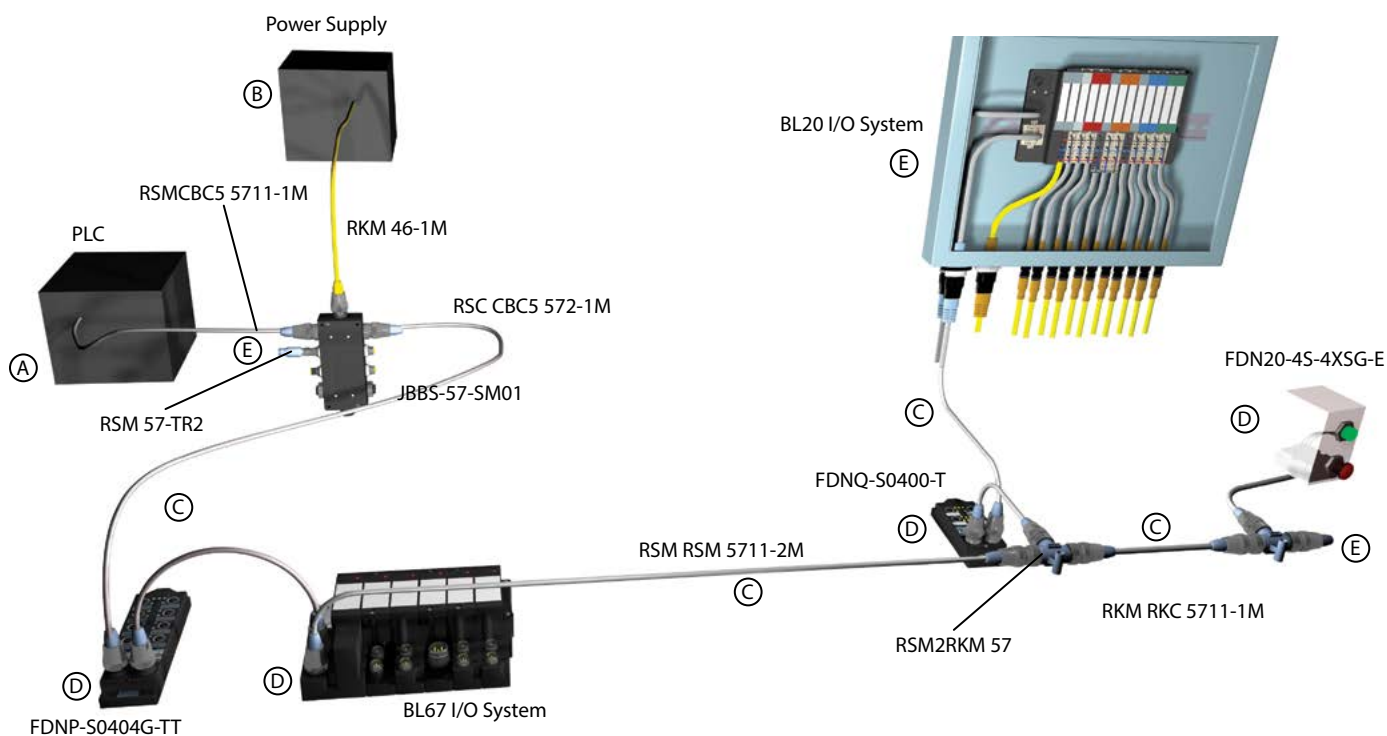

A typical DeviceNet system consists of the following parts:

- A - Controller
- B - Power Supply
- C - DeviceNet Cable
- D - DeviceNet I/O Modules (or Slaves)
- E - Terminating Resistors

DeviceNet stations require a network master (also called a scanner) to interface the stations to the host controller. Turck DeviceNet stations are designed to be fully compatible with DeviceNet equipment from other manufacturers.



## Cordsets

Turck offers a complete line of molded DeviceNet cordsets to facilitate network installation, resulting in a faster start-up and fewer wiring errors. The bus and drop cables are specially designed foil-shielded, high-flex cables with very low inductance and capacitance to minimize propagation delay time. DeviceNet cables consist of a shielded and twisted data pair, as well as a shielded and twisted power pair for the 24 VDC bus power, with an additional outer shield. The 24 VDC power pair provides bus power to the station's communication electronics and (typically) to input circuits.

The data lines for CAN-High and CAN-Low differential signals conform to the CAN standard, and support network data exchange at the maximum transmission speed of 500 kbps.

In most cases, bus cable connections are made using 5-pin Minifast® (7/8-16 UN) or Eurofast® (M12) connectors. A variety of stations are also available that support terminal-block type connections. Stations with output circuits for DC actuators normally require 24 VDC auxiliary power fed through a separate connection from the communication bus.

Turck cordsets for the DeviceNet system are available in standard lengths. Contact your local sales representative to order custom lengths.

## Diagnostics

Turck stations provide increased diagnostics when used with standard proximity or photoelectric sensors and discrete actuators. Turck stations also serve as a buffer between I/O devices and the DeviceNet bus by detecting short-circuits without disrupting DeviceNet communication.

For deluxe style stations, each I/O point on the station provides state and status data. State data represents the real world value of the I/O device; for example, when the sensor is on or the actuator is off. Status data indicates short-circuits in the I/O device or in the wiring between the device and the station. Some models also use status data to indicate open circuits.

State and status data are transferred to the DeviceNet scanner where it is available for fault handling in the control program. Additionally, each input and output has a multicolored LED to indicate its state and status and pinpoint I/O problems quickly; for example, the module status LED indicates the internal health of the station, and the network status LED indicates the station's communication on the DeviceNet network.

## Addressing

The valid range of DeviceNet node addresses is 0 to 63. The station's default node address is 63. Each node's address must be initially set, usually via rotary dials or switches on the node. The address can also be set with a DeviceNet configuration tool.

Changes to the address settings take effect when the station power is cycled. Care must be taken to prevent the same address from being assigned to more than one node in a system. If the same address is set on multiple nodes, one node will take control of the address and the others will go into "Critical Link Failure" state, indicated by the network status LED (solid red).

# DeviceNet™ Physical Media Connectivity

## Minifast® Cordset Part Number Key

Part Number Keys are to assist in IDENTIFICATION ONLY. Consult factory for catalog items not identified.

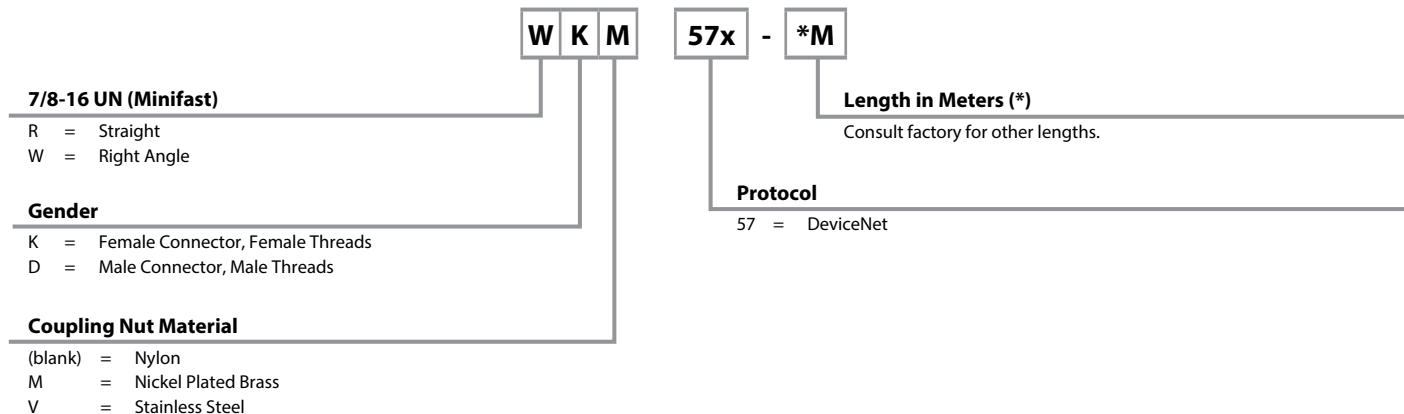

## Minifast Receptacle Part Number Key

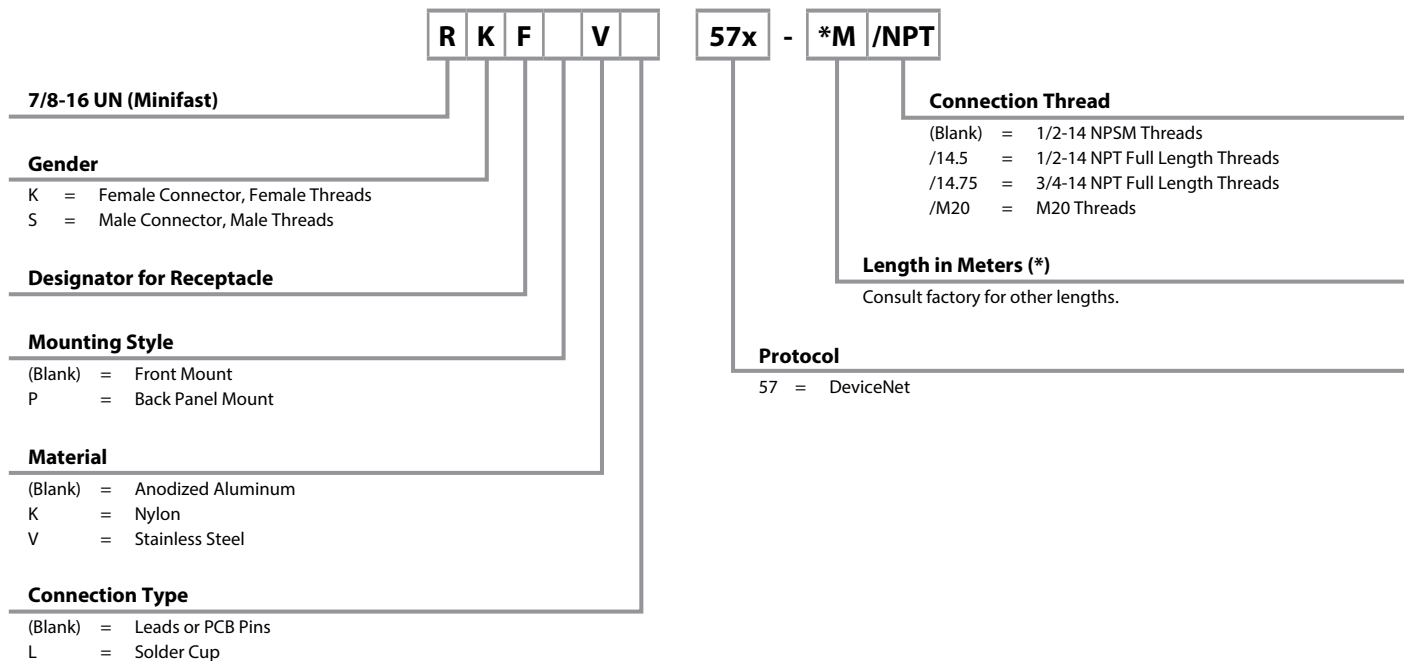

## Eurofast® Cordset Part Number Key

Part Number Keys are to assist in IDENTIFICATION ONLY. Consult factory for catalog items not identified.

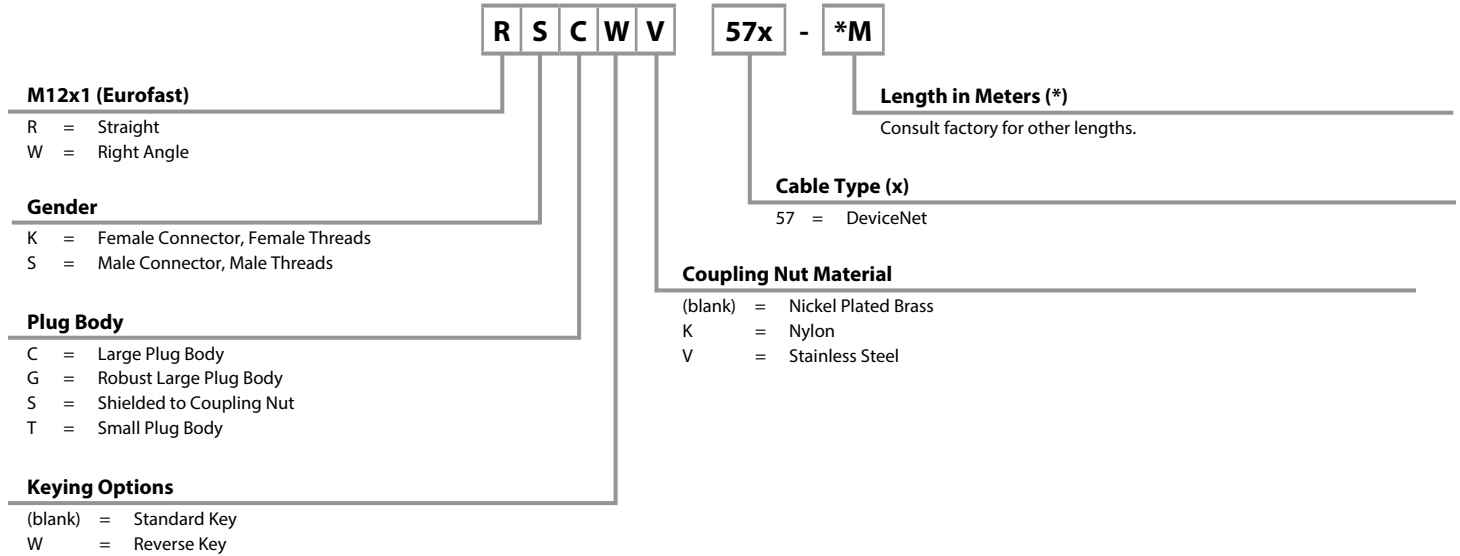

## Eurofast Receptacle Part Number Key

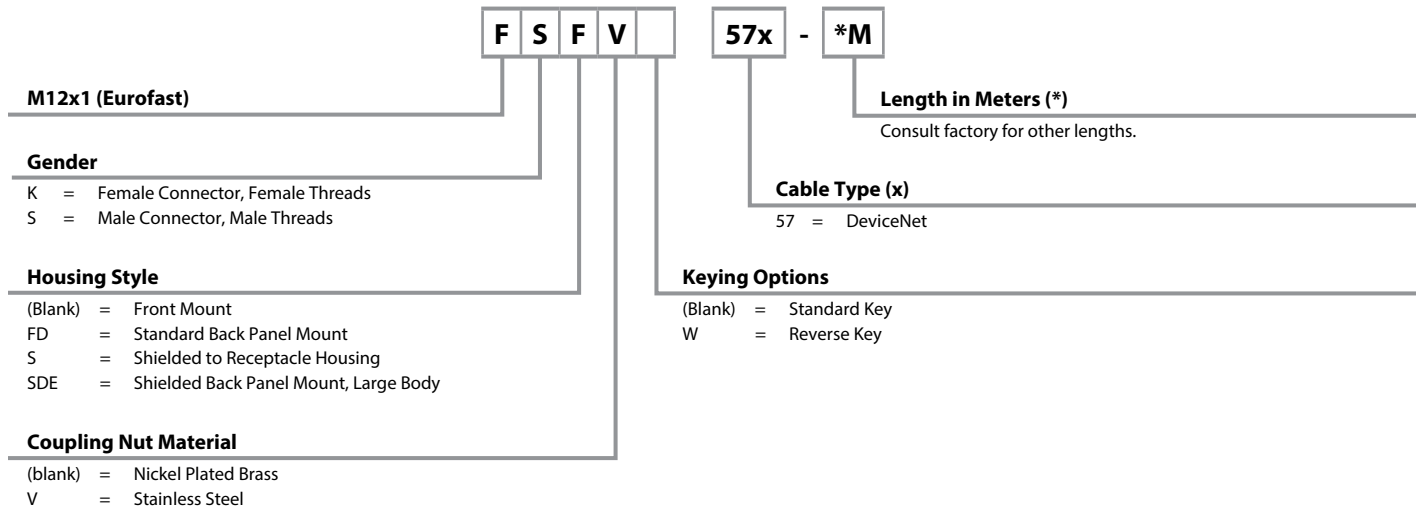

# DeviceNet™ Physical Media Connectivity

## Picofast® Part Number Key

Part Number Keys are to assist in IDENTIFICATION ONLY. Consult factory for catalog items not identified.

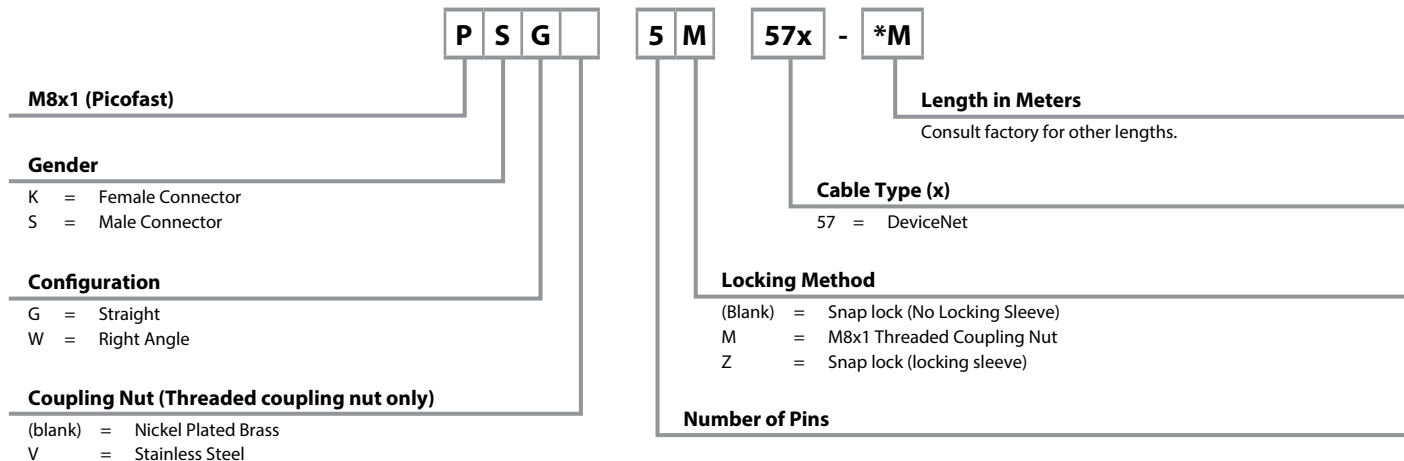

## M8 Picofast Receptacle Part Number Key

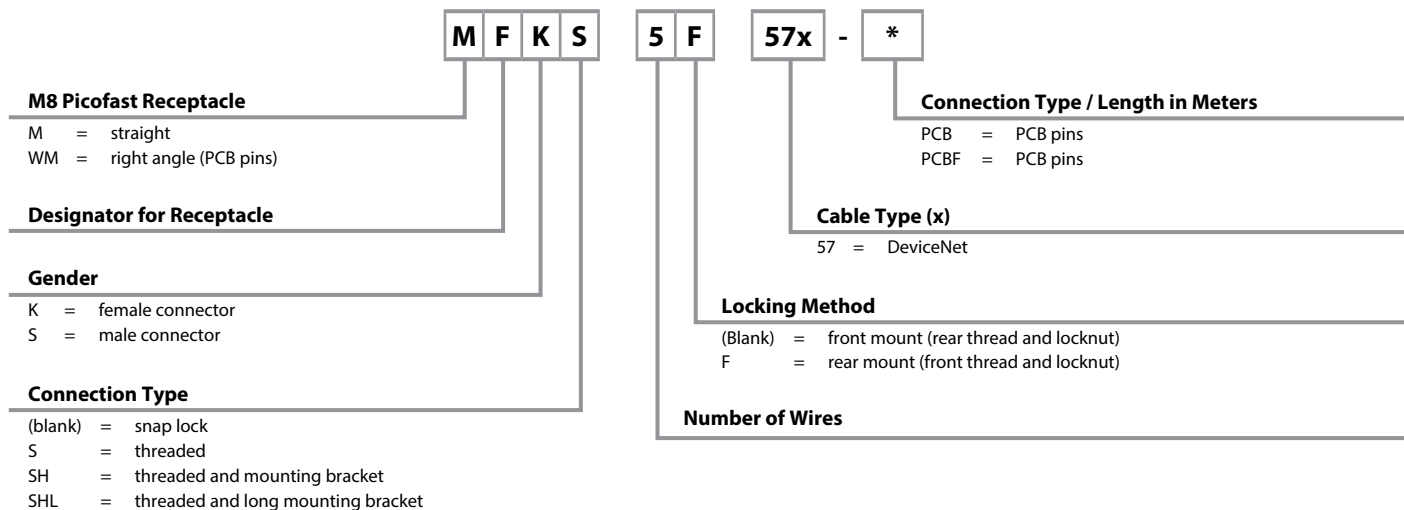

We reserve the right to make technical alterations without prior notice.

## DeviceNet, Thin Cable Specifications

- Cable that meets the requirements of ODVA Thin or Type 1 Cable
- Commonly used as Drop Cable to a maximum length of 6 meters (20 Feet) or Trunk Cable in Networks up to a maximum length of 100 meters (328 feet)

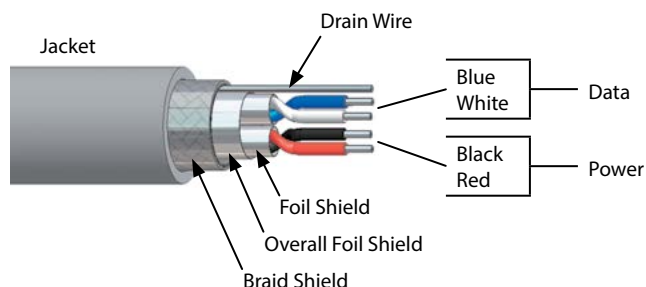

| Data Rate | Maximum Trunk Length  | Drop Length        |                       |
|-----------|-----------------------|--------------------|-----------------------|
|           |                       | Maximum            | Cumulative            |
| 125 Kbaud | 100 meters (328 feet) | 6 meters (20 feet) | 156 meters (512 feet) |
| 250 Kbaud | 100 meters (328 feet) |                    | 78 meters (256 feet)  |
| 500 Kbaud | 100 meters (328 feet) |                    | 39 meters (128 feet)  |

| Type                        | Approvals   | Power Pair        |                             | Data Pair         |   | Outer Jacket                               | Shields                        | Bulk Cable Part Number / Weight/300 M        |
|-----------------------------|---|-------------------|-----------------------------|-------------------|---|--|--------------------------------|--|
|                             |   | AWG Color Code    | DCR (/1000 feet) Insulation | AWG Color Code    | Characteristic Impedance 1 MHz/Insulation |  |                                |  |
| <b>572</b><br>80 °C, 300 V  | UL PLTC<br>CSA CMX-OUTDOOR-CMG<br>AWM I/II A/B, FT 4      | 2X22 AWG<br>BK/RD | 18.1 Ohms<br>PVC            | 2X22 AWG<br>BU/WH | 120 Ohms<br>HDPE                          | PVC, GRAY,<br>7.2 mm (.285 in)             | Foil, 22 AWG                   | RB50603-*M,<br>44 lbs.                       |
| <b>577</b><br>80 °C, 300 V  | UL PLTC<br>CSA CMX-OUTDOOR-CMG<br>AWM I/II A/B, FT 4      | 2X22 AWG<br>BK/RD | 17.5 Ohms<br>PVC            | 2X22 AWG<br>BU/WH | 120 Ohms<br>HDPE                          | PVC, GRAY,<br>8.4 mm (.330 in)             | Foil/braid,<br>22 AWG          | RB50629-*M,<br>65 lbs.<br>Flexlife®          |
| <b>578</b><br>80 °C, 600 V  | UL PLTC, CL2<br>CSA CMX-OUTDOOR-CMG<br>AWM I/II A/B, FT 4 | 2X22 AWG<br>BK/RD | 18.1 Ohms<br>PVC            | 2X22 AWG<br>BU/WH | 120 Ohms<br>HDPE                          | PVC, GRAY,<br>7.9 mm (.310 in)             | Foil/braid,<br>22 AWG          | RB50651-*M,<br>51 lbs.                       |
| <b>5715</b><br>80 °C, 300 V | UL recognized AWM<br>CSA AWM I/II A/B, FT 1               | 2X22 AWG<br>BK/RD | 18.1 Ohms<br>PVC            | 2X22 AWG<br>BU/WH | 120 Ohms<br>HDPE                          | PVC, GRAY,<br>6.0 mm (.235 in)             | Foil<br>(data only),<br>22 AWG | RB50764-*M,<br>26 lbs.                       |
| <b>5725</b><br>80 °C, 300 V | UL recognized AWM<br>CSA AWM I/II A/B, FT 1               | 2X22 AWG<br>BK/RD | 18.1 Ohms<br>PO             | 2X24 AWG<br>BU/WH | 120 Ohms<br>PE                            | TPU, VIOLET,<br>7.0 mm (.276 in)           | Foil/braid,<br>22 AWG          | RB51916-*M,<br>50 lbs.<br>Halogen-free       |
| <b>5732</b><br>80 °C, 600 V | UL recognized AWM<br>CSA AWM I/II A/B, FT 1               | 2X22 AWG<br>BK/RD | 18.1 Ohms<br>PVC            | 2X22 AWG<br>BU/WH | 120 Ohms<br>HDPE                          | TPE, CHARCOAL<br>GRAY, 8.5 mm<br>(.335 in) | Foil/braid,<br>22 AWG          | RB51296-*M,<br>68 lbs.<br>Flexlife, Weldlife |

\* Indicates length in meters.

Standard spool lengths are 30, 75, 100, 150, 200, 225, 300 meters. Consult factory for other lengths.

†† Zero Halogen: to DIN VDE 0472 part 815 + IEC 60754-1

We reserve the right to make technical alterations without prior notice.

DeviceNet™ Media

# DeviceNet™ Physical Media Connectivity

## DeviceNet, Mid Cable Specifications

- Cable that meets the requirements of ODVA Mid or Type III Cable
- Provides more flexibility when used as a Trunk Cable up to a maximum length of 300 meters (984 feet)

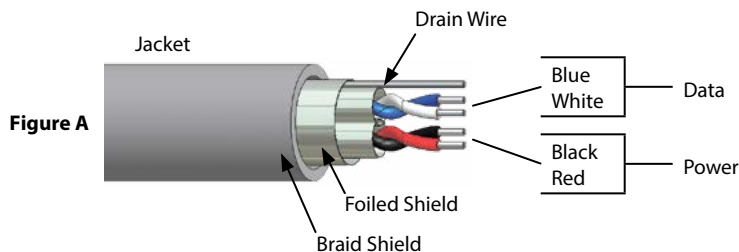

| Data Rate | Maximum Trunk Length  |
|-----------|-----------------------|
| 125 Kbaud | 300 meters (984 feet) |
| 250 Kbaud | 250 meters (820 feet) |
| 500 Kbaud | 100 meters (328 feet) |

| Type                        | Approvals  | Power Pair        |                             | Data Pair         |   | Outer Jacket                   | Shields               | Bulk Cable Part Number / Weight/300 M |
|-----------------------------|--|-------------------|-----------------------------|-------------------|---|--------------------------------|-----------------------|---------------------------------------|
|                             |  | AWG Color Code    | DCR (/1000 feet) Insulation | AWG Color Code    | Characteristic Impedance 1 MHz/Insulation | Material Color Nominal O.D.    | Type Drain Wire       |                                       |
| <b>5711</b><br>80 °C, 300 V | UL PLTC<br>CSA CMX-OUTDOOR-CMG<br>AWM I/II A/B, FT 4 | 2X16 AWG<br>BK/RD | 4.1 Ohms<br>PVC             | 2X20 AWG<br>BU/WH | 120 Ohms<br>HDPE                          | PVC, GRAY,<br>8.4 mm (.330 in) | Foil, 20 AWG          | RB50721-*M,<br>65 lbs.                |
| <b>5722</b><br>80 °C, 300 V | UL PLTC<br>CSA CMX-OUTDOOR-CMG<br>AWM I/II A/B, FT 4 | 2X17 AWG<br>BK/RD | 5.8 Ohms<br>PVC             | 2X20 AWG<br>BU/WH | 110 Ohms<br>HDPE                          | PVC, GRAY,<br>8.9 mm (.350 in) | Foil, 20 AWG          | RB50876-*M,<br>71 lbs.<br>Flexlife®   |
| <b>5723</b><br>80 °C, 300 V | UL recognized AWM<br>CSA AWM I/II A/B, FT 1          | 2X17 AWG<br>BK/RD | 5.8 Ohms<br>PVC             | 2X20 AWG<br>BU/WH | 110 Ohms<br>HDPE                          | TPU, GRAY,<br>8.4 mm (.330 in) | Foil, 20 AWG          | RB50877-*M,<br>60 lbs.<br>Flexlife    |
| <b>5731</b><br>80 °C, 300 V | UL recognized AWM<br>CSA AWM I/II A/B, FT 1          | 2X16 AWG<br>BK/RD | 4.1 Ohms<br>PVC             | 2X20 AWG<br>BU/WH | 120 Ohms<br>HDPE                          | TPE, GRAY,<br>9.6 mm (.378 in) | Foil/braid,<br>20 AWG | RB51235-*M,<br>95 lbs.<br>Weldlife    |
| <b>5737</b><br>80 °C, 300 V | UL recognized AWM<br>CSA AWM I/II A/B, FT 1          | 2X17 AWG<br>BK/RD | 5.8 Ohms<br>PVC             | 2X20 AWG<br>BU/WH | 110 Ohms<br>HDPE                          | TPU, GRAY,<br>8.4 mm (.330 in) | Foil, 22 AWG          | RB51903-*M,<br>60 lbs.<br>C-track     |

\* Indicates length in meters.  
Standard spool lengths are 30, 75, 100, 150, 200, 225, 300 meters. Consult factory for other lengths.

We reserve the right to make technical alterations without prior notice.

## DeviceNet, Thick Cable Specifications

- Cable that meets the requirements of ODVA Thick or Type 1 Cable
- It provides the most power to a Network when used as a Trunk Cable up to a maximum Standard Cable Length of 500 meters (1640 feet)

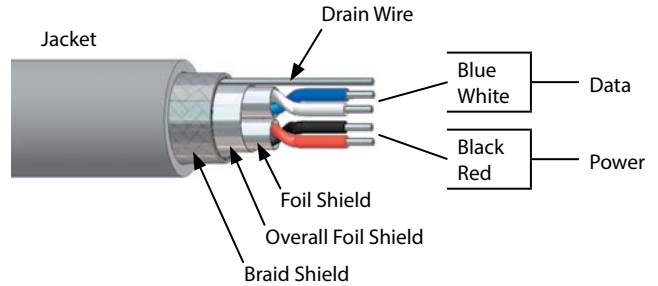

| Data Rate | Maximum Trunk Length   | Maximum Trunk Length (5720) |
|-----------|------------------------|-----------------------------|
| 125 Kbaud | 500 meters (1640 feet) | 420 meters (1378 feet)      |
| 250 Kbaud | 250 meters (820 feet)  | 200 meters (656 feet)       |

| Type                        | Approvals   | Power Pair        |                             | Data Pair         |   | Outer Jacket                                | Shields               | Bulk Cable Part Number / Weight/300 M |
|-----------------------------|---|-------------------|-----------------------------|-------------------|---|---|-----------------------|---------------------------------------|
|                             |   | AWG Color Code    | DCR (/1000 feet) Insulation | AWG Color Code    | Characteristic Impedance 1 MHz/Insulation |   |                       |                                       |
| <b>575</b><br>80 °C, 300 V  | UL recognized AWM CSA<br>AWM I/II A/B, FT 1               | 2X15 AWG<br>BK/RD | 3.6 Ohms<br>PVC             | 2X18 AWG<br>BU/WH | 120 Ohms<br>HDPE                          | TPU, GRAY,<br>10.4 mm (.409 in)             | Foil/braid,<br>18 AWG | RB50633-*M,<br>94 lbs.                |
| <b>579</b><br>80 °C, 600 V  | UL PLTC, CL2<br>CSA CMX-OUTDOOR-CMG<br>AWM I/II A/B, FT 4 | 2X15 AWG<br>BK/RD | 3.6 Ohms<br>PVC             | 2X18 AWG<br>BU/WH | 120 Ohms<br>HDPE                          | PVC, GRAY,<br>11.2 mm (.440 in)             | Foil/braid,<br>18 AWG | RB50652-*M,<br>122 lbs.               |
| <b>5720</b><br>75 °C, 600 V | UL TC-ER<br>CSA AWM I/II A/B, FT 1                        | 2X16 AWG<br>BK/RD | 4.9 Ohms<br>PVC             | 2X18 AWG<br>BU/WH | 120 Ohms<br>HDPE                          | PVC, GRAY,<br>13.3 mm (.525 in)             | Foil/braid,<br>16 AWG | RB50793-*M,<br>168 lbs.               |
| <b>5727</b><br>80 °C, 600 V | UL PLTC<br>CSA CMX-OUTDOOR-CMG<br>AWM I/II A/B, FT 4      | 2X15 AWG<br>BK/RD | 3.6 Ohms<br>PVC             | 2X18 AWG<br>BU/WH | 120 Ohms<br>HDPE                          | PVC,<br>CHARCOAL GRAY,<br>12.5 mm (.492 in) | Foil/braid,<br>18 AWG | RB51106-*M,<br>157 lbs.<br>Flexlife   |
| <b>5730</b><br>80 °C, 600 V | UL recognized AWM<br>CSA AWM I/II A/B, FT 1               | 2X15 AWG<br>BK/RD | 3.6 Ohms<br>PVC             | 2X18 AWG<br>BU/WH | 120 Ohms<br>HDPE                          | TPE, GRAY,<br>10.5 mm (.254 in)             | Foil/braid,<br>18 AWG | RB51231-*M,<br>110 lbs.<br>Weldlife   |



\* Indicates length in meters.  
Standard spool lengths are 30, 75, 100, 150, 200, 225, 300 meters. Consult factory for other lengths.

We reserve the right to make technical alterations without prior notice.

DeviceNet™ Media

# DeviceNet™ Physical Media Connectivity

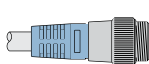
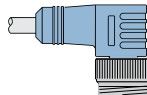
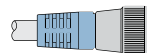
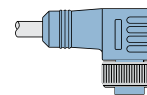
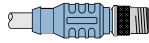
## DeviceNet, Cable/Cordset Selection Matrix

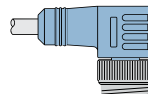
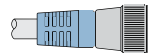
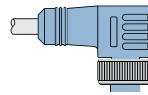
|   |   | Minifast®   |   |   |   | Eurofast® Thin/Mid Only   |
|---|---|---|---|---|---|---|
|   |   | (Male)  |   | (Female)  |   | Male  |
|   |   | 1  | 2  | 3  | 4  | 7  |
|   |   | RSM   | WSM   | RKM   | WKM   | RSC   |
|  |   | RSM 57x-*M  | WSM 57x-*M  | RKM 57x-*M  | WKM 57x-*M  | RSC 57x-*M  |
| Bare  |   |   |   |   |   |   |
| Minifast (Male)   | 1    | RSM RSM 57x-*M  | RSM WSM 57x-*M  | RSM RKM 57x-*M  | RSM WKM 57x-*M  | RSM RSC 57x-*M  |
|   | RSM   |   |   |   |   |   |
| Minifast (Female)   | 2    |   | WSM WSM 57x-*M  | WSM RKM 57x-*M  | WSM WKM 57x-*M  | WSM RSC 57x-*M  |
|   | WSM   |   |   |   |   |   |
| Minifast (Female)   | 3    |   |   | RKM RKM 57x-*M  | RKM WKM 57x-*M  | RKM RSC 57x-*M  |
|   | RKM   |   |   |   |   |   |
| Minifast (Female)   | 4  |   |   |   | WKM WKM 57x-*M  | WKM RSC 57x-*M  |
|   | WKM   |   |   |   |   |   |

See pages M16 - M17 for dimensional drawings.

\* Indicates length in meters.

x Indicates cable type.

Standard cable lengths are 1, 2, 4, 6, 8, 10, 15, and in +5 meter increments from there. Consult factory for other lengths.

For stainless steel coupling nuts change part number RSM ... to RSV, WSM ... to WSV.

We reserve the right to make technical alterations without prior notice.

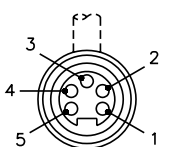
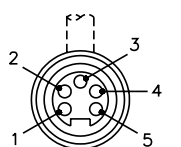
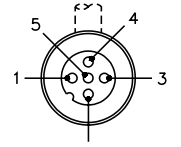
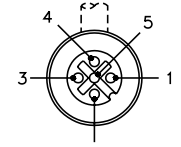
| Minifast  |   | Pinouts  | Eurofast  |   |
|---|---|--|---|---|
| Male  | Female  |  | Male  | Female  |
|  |  | 1. Bare (Shield Drain Wire)<br>2. Red (+ Voltage)<br>3. Black (- Voltage)<br>4. White (CAN_H)<br>5. Blue (CAN_L) |  |  |



DeviceNet, Cable/Cordset Selection Matrix

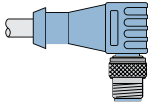
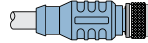
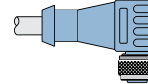
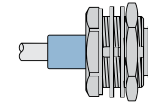
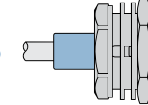
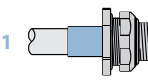
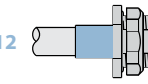



| Eurofast® (Thin/Mid Only)   |   |  | Minifast® Bulkhead   |   | Eurofast Bulkhead (Thin Only)   |   |
|---|---|--|--|---|---|---|
| Male  | Female  | Female   | Male   | Female  | Male  | Female  |
|  <p>8</p> <p>WSC</p> |  <p>9</p> <p>RKC</p> |  <p>10</p> <p>WKC</p> |  <p>5</p> <p>RSFP</p> |  <p>6</p> <p>RKFP</p> |  <p>11</p> <p>FSFD</p> |  <p>12</p> <p>FKFD</p> |
| WSC 57x-*M  | RKC 57x-*M  | WKC 57x-*M   | RSFP 57x-*M  | RKFP 57x-*M   | FSFD 57x-*M   | FKFD 57x-*M   |
| RSM WSC 57x-*M  | RSM RKC 57x-*M  | RSM WKC 57x-*M   | RSM RSFP 57x-*M  | RSM RKFP 57x-*M   | RSM FSFD 57x-*M   | RSM FKFD 57x-*M   |
| WSM WSC 57x-*M  | WSM RKC 57x-*M  | WSM WKC 57x-*M   | WSM RSFP 57x-*M  | WSM RKFP 57x-*M   | WSM FSFD 57x-*M   | WSM FKFD 57x-*M   |
| RKM WSC 57x-*M  | RKM RKC 57x-*M  | RKM WKC 57x-*M   | RKM RSFP 57x-*M  | RKM RKFP 57x-*M   | RKM FSFD 57x-*M   | RKM FKFD 57x-*M   |
| WKM WSC 57x-*M  | WKM RKC 57x-*M  | WKM WKC 57x-*M   | WKM RSFP 57x-*M  | WKM RKFP 57x-*M   | WKM FSFD 57x-*M   | WKM FKFD 57x-*M   |

We reserve the right to make technical alterations without prior notice.

DeviceNet™ Media

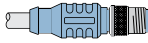
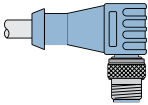
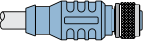
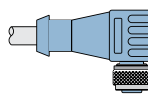
# DeviceNet™ Physical Media Connectivity

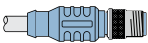
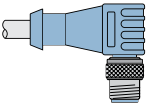
## DeviceNet, Cable/Cordset Selection Matrix

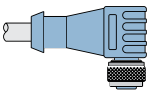
|   |  | Eurofast® (Thin/Mid Only)   |   |   |  |
|---|--|---|---|---|--|
|   |  | Male  |   | Female  |  |
|   |  | 7  | 8  | 9  | 10  |
|   |  | RSC   | WSC   | RKC   | WKC  |
|  |  | RSC 57x-*M  | WSC 57x-*M  | RKC 57x-*M  | WKC 57x-*M   |
| Bare  |  |   |   |   |  |
| Eurofast (Male)<br>Thin/Mid Only  | 7     | RSC RSC 57x-*M  | RSC WSC 57x-*M  | RSC RKC 57x-*M  | RSC WKC 57x-*M   |
|   | RSC  |   |   |   |  |
| Eurofast (Female)<br>Thin/Mid Only  | 8     |   | WSC WSC 57x-*M  | WSC RKC 57x-*M  | WSC WKC 57x-*M   |
|   | WSC  |   |   |   |  |
| Eurofast (Female)<br>Thin/Mid Only  | 9     |   |   | RKC RKC 57x-*M  | RKC WKC 57x-*M   |
|   | RKC  |   |   |   |  |
| Eurofast (Female)<br>Thin/Mid Only  | 10  |   |   |   | WKC WKC 57x-*M   |
|   | WKC  |   |   |   |  |

See pages M16 - M17 for dimensional drawings.

\* Indicates length in meters.

x Indicates cable type.

Standard cable lengths are 1, 2, 4, 6, 8, 10, 15, and in +5 meter increments from there. Consult factory for other lengths.

For stainless steel coupling nuts change part number RSM ... to RSV, WSM ... to WSV.

We reserve the right to make technical alterations without prior notice.

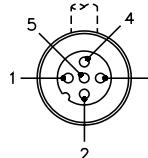
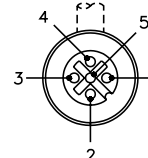
| Pinouts  | Eurofast  |   |
|--|---|---|
|  | Male  | Female  |
| <ol style="list-style-type: none"> <li>1. Bare (Shield Drain Wire)</li> <li>2. Red (+ Voltage)</li> <li>3. Black (- Voltage)</li> <li>4. White (CAN_H)</li> <li>5. Blue (CAN_L)</li> </ol> |  |  |

## DeviceNet, Cable/Cordset Selection Matrix



| Minifast® Bulkhead |                 | Eurofast® Bulkhead (Thin Only) |                 |
|--------------------|-----------------|--------------------------------|-----------------|
| Male               | Female          | Male                           | Female          |
| <br>5<br>RSFP      | <br>6<br>RKFP   | <br>11<br>FSFD                 | <br>12<br>FKFD  |
| RSFP 57x-*M        | RKFP 57x-*M     | FSFD 57x-*M                    | FKFD 57x-*M     |
| RSC RSFP 57x-*M    | RSC RKFP 57x-*M | RSC FSFD 57x-*M                | RSC FKFD 57x-*M |
| WSC RSFP 57x-*M    | WSC RKFP 57x-*M | WSC FSFD 57x-*M                | WSC FKFD 57x-*M |
| RKC RSFP 57x-*M    | RKC RKFP 57x-*M | RKC FSFD 57x-*M                | RKC FKFD 57x-*M |
| WKC RSFP 57x-*M    | WKC RKFP 57x-*M | WKC FSFD 57x-*M                | WKC FKFD 57x-*M |

We reserve the right to make technical alterations without prior notice.

DeviceNet™ Media

# DeviceNet™ Physical Media Connectivity

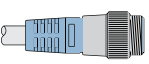
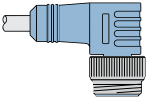
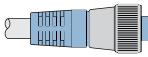
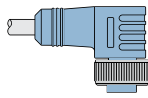
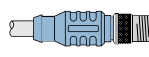
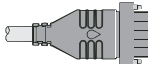
## DeviceNet, Open Connector Cordset Selection Matrix

|  |                           | Minifast®  |  |   |  | Eurofast®  |
|--|---------------------------|--|--|---|--|--|
|  |                           | (Male)   |  | (Female)  |  | Male   |
|  |                           | 1 <br>RSM | 2 <br>WSM | 3 <br>RKM | 4 <br>WKM | 7 <br>RSC |
| 15 <br>Bare | CBC5 57x-*M               | RSM CBC5 57x-*M  | WSM CBC5 57x-*M  | RKM CBC5 57x-*M   | WKM CBC5 57x-*M  | RSC CBC5 57x-*M  |
| 16 <br>Bare | BK52C 57x-*M              | RSM BK52C 57x-*M   | WSM BK52C 57x-*M   | RKM BK52C 57x-*M  | WKM BK52C 57x-*M   | RSC BK52C 57x-*M   |
|  | Thin, Mid and Thick Cable |  |  |   |  | Thin Cable Only  |

See pages M16 - M17 for dimensional drawings.

\* Indicates length in meters.

x Indicates cable type.

Standard cable lengths are 1, 2, 4, 6, 8, 10, 15, and in +5 meter increments from there. Consult factory for other lengths.

For stainless steel coupling nut: Change part number (RSM ... to RSV, RSC ... to RSCV).

We reserve the right to make technical alterations without prior notice.

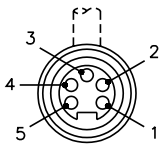
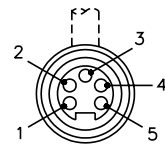
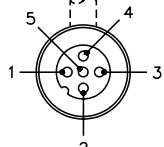
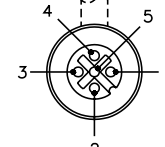
| Minifast  |   | Pinouts  | Eurofast  |   |
|---|---|--|---|---|
| Male  | Female  |  | Male  | Female  |
|  |  | 1. Bare (Shield Drain Wire)<br>2. Red (+ Voltage)<br>3. Black (- Voltage)<br>4. White (CAN_H)<br>5. Blue (CAN_L) |  |  |

DeviceNet, Open Connector Cordset Selection Matrix

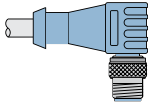
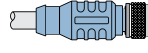
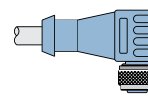
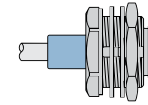
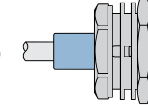
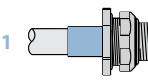
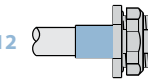
| Eurofast®   |   |  | Minifast® Bulkhead  |  | Eurofast Bulkhead  |  |
|---|---|--|---|--|--|--|
| Male  | Female  | Female   | Male  | Female   | Male   | Female   |
| 8  | 9  | 10  | 5  | 6  | 11  | 12  |
| WSC   | RKC   | WKC  | RSFP  | RKFP   | FSFD   | FKFD   |
| WSC CBC5 57x-*M   | RKC CBC5 57x-*M   | WKC CBC5 57x-*M  | RSFP CBC5 57x-*M  | RKFP CBC5 57x-*M   | FSFD CBC5 57x-*M   | FKFD CBC5 57x-*M   |
| WSC BK52C 57x-*M  | RKC BK52C 57x-*M  | WKC BK52C 57x-*M   | RSFP BK52C 57x-*M   | RKFP BK52C 57x-*M  | FSFD BK52C 57x-*M  | FKFD BK52C 57x-*M  |
| Thin and Mid Cable Only   |   |  | Thin, Mid and Thick Cable   |  | Thin Cable Only  |  |

See pages M16 - M17 for dimensional drawings.

\* Indicates length in meters.

x Indicates cable type.

Standard cable lengths are 1, 2, 4, 6, 8, 10, 15, and in +5 meter increments from there. Consult factory for other lengths.

Specifications

|                         |                       |                             |                                      |
|-------------------------|-----------------------|-----------------------------|--------------------------------------|
| <b>Overmold:</b>        | TPU                   | <b>Rated Voltage:</b>       | 250 V                                |
| <b>Contact Carrier:</b> | PA (Nylon)            | <b>Rated Current:</b>       | 12 A                                 |
| <b>Protection:</b>      | NEMA 1, and IEC IP 20 | <b>Ambient Temperature:</b> | -40 °C to +75 °C (-22 °F to +167 °F) |

We reserve the right to make technical alterations without prior notice.

DeviceNet™ Media

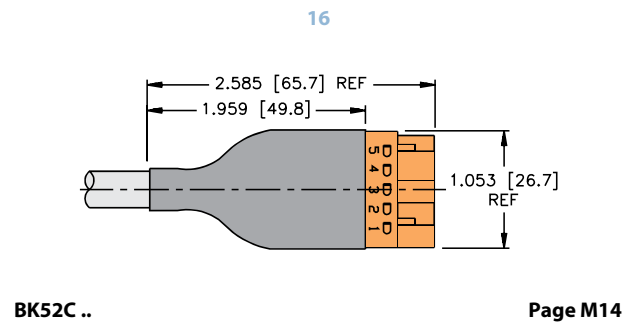
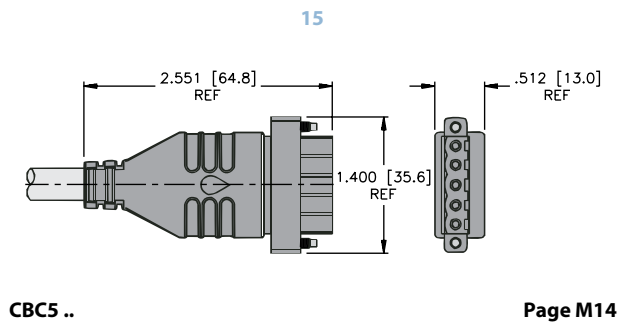

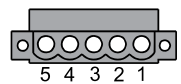
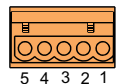
| CBC5  | Pinouts  | BK52C   |
|---|--|---|
|  | 1 = Black (- Voltage)<br>2 = Blue (CAN_L)<br>3 = Bare (Shield Drain)<br>4 = White (CAN_H)<br>5 = Red (+ Voltage) |  |

### Specifications

|                         |                                       |                             |                                      |
|-------------------------|---------------------------------------|-----------------------------|--------------------------------------|
| <b>Overmold:</b>        | TPU                                   | <b>Protection:</b>          | NEMA 1, 3, 4, 6P and IEC IP 67       |
| <b>Coupling Nut:</b>    | Nickel Plated CuZn or Stainless Steel | <b>Rated Voltage:</b>       | 300 V                                |
| <b>Contact Carrier:</b> | TPU                                   | <b>Ambient Temperature:</b> | -40 °C to +75 °C (-22 °F to +167 °F) |
| <b>Contacts:</b>        | Gold Plated CuZn                      |                             |                                      |

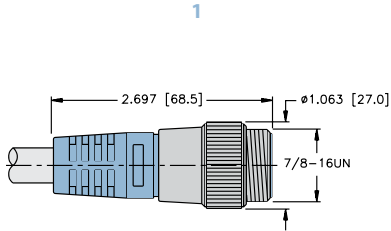

RSM ..

Page M10

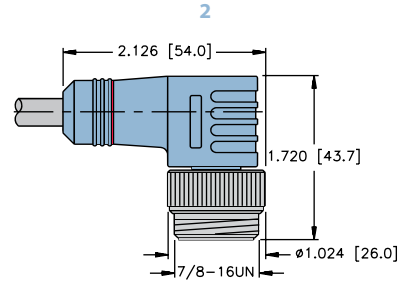

WSM ..

Page M10

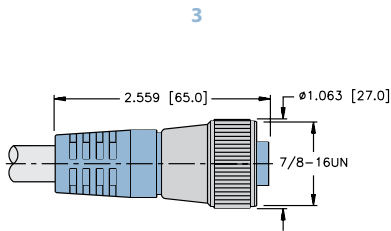

RKM ..

Page M10

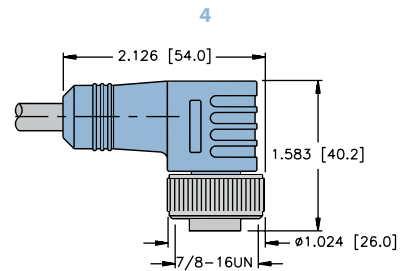

WKM ..

Page M10

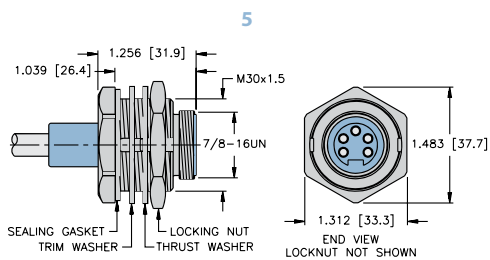

RSFP ..

Page M11

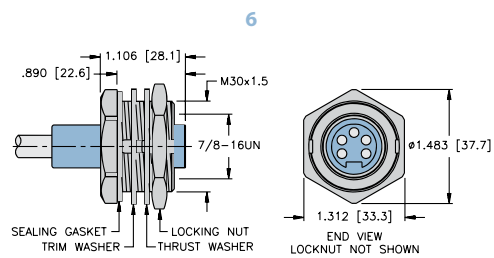

RKFP ..

Page M11

We reserve the right to make technical alterations without prior notice.

**Specifications**

|                         |                                       |                             |                                      |
|-------------------------|---------------------------------------|-----------------------------|--------------------------------------|
| <b>Overmold:</b>        | TPU                                   | <b>Protection:</b>          | NEMA 1, 3, 4, 6P and IEC IP 68       |
| <b>Coupling Nut:</b>    | Nickel Plated CuZn or Stainless Steel | <b>Rated Voltage:</b>       | 250 V                                |
| <b>Contact Carrier:</b> | TPU or POM (Nylon)                    | <b>Rated Current:</b>       | 4 A                                  |
| <b>Contacts:</b>        | Gold Plated CuZn                      | <b>Ambient Temperature:</b> | -40 °C to +75 °C (-22 °F to +167 °F) |

We reserve the right to make technical alterations without prior notice.

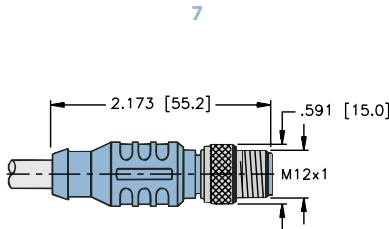

RSC ..

Page M10

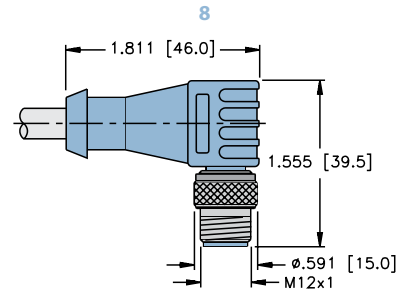

WSC ..

Page M11

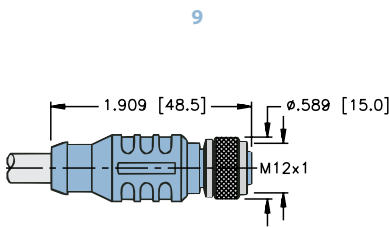

RKC ..

Page M11

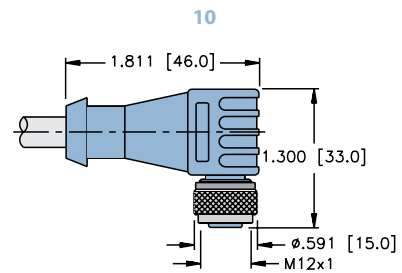

WKC ..

Page M11

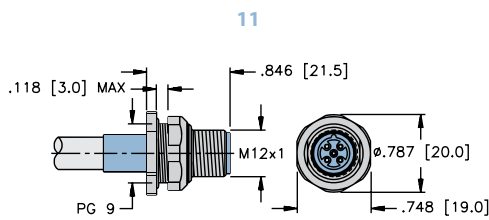

FSFD ..

Page M11

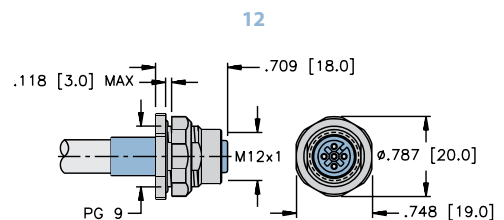

FKFD ..

Page M11

DeviceNet™ Media

# DeviceNet™ Physical Media Connectivity

## DeviceNet, Pico Cable Specifications

- Cable that meets the electrical requirements of ODVA Thin Cable
- Pico Cable has 24 AWG Conductors which may be used with Picofast® Connectors

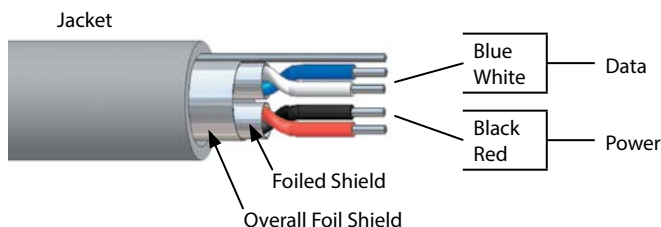

DeviceNet - Pico Cable 5724

| Data Rate | Maximum Trunk Length |
|-----------|----------------------|
| 125 Kbaud | 35 meters (115 feet) |
| 250 Kbaud | 35 meters (115 feet) |
| 500 Kbaud | 35 meters (115 feet) |

DeviceNet - Thin Cable 5715

| Data Rate | Maximum Trunk Length  |
|-----------|-----------------------|
| 125 Kbaud | 100 meters (328 feet) |
| 250 Kbaud | 100 meters (328 feet) |
| 500 Kbaud | 100 meters (328 feet) |

| Type                        | Approvals                                   | Power Pair        |                             | Data Pair         |   | Outer Jacket                   | Shields                        | Bulk Cable Part Number / Weight/300 M |
|-----------------------------|---|-------------------|-----------------------------|-------------------|---|--------------------------------|--------------------------------|---------------------------------------|
|                             |   | AWG Color Code    | DCR (/1000 feet) Insulation | AWG Color Code    | Characteristic Impedance 1 MHz/Insulation | Material Color Nominal O.D.    | Type Drain Wire                |                                       |
| <b>5724</b><br>80 °C, 300 V | UL recognized AWM<br>CSA AWM I/II A/B, FT 1 | 2X24 AWG<br>BK/RD | 24.9 Ohms<br>PVC            | 2X24 AWG<br>BU/WH | 120 Ohms<br>HDPE                          | PVC, GRAY,<br>5.7 mm (.224 in) | Foil, 24 AWG                   | RB51045-*M,<br>27 lbs.                |
| <b>5715</b><br>80 °C, 300 V | UL recognized AWM<br>CSA AWM I/II A/B, FT 1 | 2X22 AWG<br>BK/RD | 18.1 Ohms<br>PVC            | 2X22 AWG<br>BU/WH | 120 Ohms<br>HDPE                          | PVC, GRAY,<br>6.0 mm (.235 in) | Foil<br>(data only),<br>22 AWG | RB50764-*M,<br>26 lbs.                |

\* Indicates length in meters.  
Standard cable lengths are 1, 2, 4, 6, 8, 10, 15, and in +5 meter increments from there. Consult factory for other lengths.

We reserve the right to make technical alterations without prior notice.



## DeviceNet, Cable/Cordsets Selection Matrix - Threaded

|                   |             | Picofast® (M8)    |                   |                   |                   | Eurofast® (M12)  |                  |                  |                  |
|-------------------|-------------|-------------------|-------------------|-------------------|-------------------|------------------|------------------|------------------|------------------|
|                   |             | Female            |                   | Male              |                   | Male             |                  | Female           |                  |
|                   |             | 3<br>PKG 5M       | 4<br>PKW 5M       | 1<br>PSG 5M       | 2<br>PSW 5M       | 7<br>RST         | 8<br>WST         | 9<br>RKT         | 10<br>WKT        |
| Bare              |             | PKG 5M-57x        | PKW 5M-57x        | PSG 5M-57x        | PSW 5M-57x        | RST 57x*         | WST 57x          | RKT 57x*         | WKT 57x*         |
| Picofast (Female) | 3<br>PKG 5M | PKG 5M PKG 5M-57x | PKW 5M PKW 5M-57x | PKG 5M PSG 5M-57x | PKG 5M PSW 5M-57x | PKG 5M RST 57x*M | PKG 5M WST 57x*M | PKG 5M RKT 57x*M | PKG 5M WKT 57x*M |
|                   | 4<br>PKW 5M |                   | PKW 5M PKW 5M-57x | PKW 5M PSG 5M-57x | PKW 5M PSW 5M-57x | PKW 5M RST 57x*M | PKW 5M WST 57x*M | PKW 5M RKT 57x*M | PKW 5M WKT 57x*M |
| Picofast (Male)   | 1<br>PSG 5M |                   |                   | PSG 5M PSG 5M-57x | PSG 5M PSW 5M-57x | PSG 5M RST 57x*M | PSG 5M WST 57x*M | PSG 5M RKT 57x*M | PSG 5M WKT 57x*M |
|                   | 2<br>PSW 5M |                   |                   |                   | PSW 5M PSW 5M-57x | PSW 5M RST 57x*M | PSW 5M WST 57x*M | PSW 5M RKT 57x*M | PSW 5M WKT 57x*M |

See pages M23 - M24 for dimensional drawings.

\* Indicates length in meters.

x Indicates cable type. See page B125 for available cable types.

Standard cable lengths are 1, 2, 6, 8, 10, 15, and in +5 meter increments from there. Consult factory for other lengths.

For stainless steel coupling nuts change part number PSG 5M ... to PSGV 5M, PSW 5M ... to PSWV 5M.

We reserve the right to make technical alterations without prior notice.

DeviceNet™ Media

| Picofast |        | Pinouts  | Eurofast |        |
|----------|--------|--|----------|--------|
| Male     | Female |  | Male     | Female |
|          |        | 1. Bare (Shield Drain Wire)<br>2. Red (+ Voltage)<br>3. Black (- Voltage)<br>4. White (CAN_H)<br>5. Blue (CAN_L) |          |        |

# DeviceNet™ Physical Media Connectivity

## DeviceNet, Cable/Cordsets Selection Matrix - Snap Lock

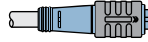
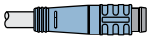
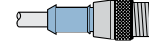
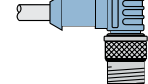
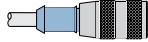
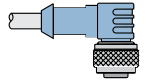
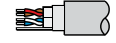
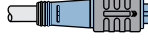
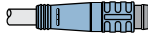
|  |   | Picofast®   |  | Eurofast®  |   |  |   |
|--|---|---|--|--|---|--|---|
|  |   | (Male)  |  | (Female)   |   | Male   | Male  |
|  |   |  6<br>PKG 5Z |  5<br>PSG 5 |  7<br>RST |  8<br>WST |  9<br>RKT |  10<br>WKT |
|  Bare |   | PKG 5Z 57x-*M   | PSG 5 57x-*M   | RST 57x-*  | WST 57x-*   | RKT 57x-*  | WKT 57x-*   |
| Picofast (Male)<br>(5724 Cable Only)   |  6<br>PKG 5Z | PKG 5Z PKGZ 5Z 57x-*M   | PKG 5Z PSG 57x-*M  | PKG 5Z RST 57x-*M  | PKG 5Z WST 57x-*M   | PKG 5Z RKT 57x-*M  | PKG 5Z WKT 57x-*M   |
|  |  5<br>PSG 5  |   | PSG 5 PSG 5 57x-*M   | PSG 5 RST 57x-*M   | PSG 5 WST 57x-*M  | PSG 5 RKT 57x-*M   | PSG 5 WKT 57x-*M  |

See pages M23 - M24 for dimensional drawings.

\* Indicates length in meters.

x Indicates cable type. See page M20 for available cable types.

Standard cable lengths are 1, 2, 4, 5, 6, 8, 10, 15, and in +5 meter increments from there. Consult factory for other lengths.

We reserve the right to make technical alterations without prior notice.

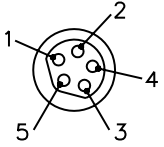
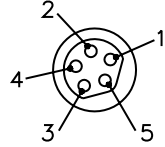
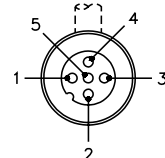
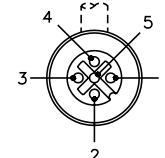
| Picofast  |   | Pinouts  | Eurofast  |   |
|---|---|--|---|---|
| Male  | Female  |  | Male  | Female  |
|  |  | 1. Bare (Shield Drain Wire)<br>2. Red (+ Voltage)<br>3. Black (- Voltage)<br>4. White (CAN_H)<br>5. Blue (CAN_L) |  |  |

Specifications

|                         |  |                             |                                      |
|-------------------------|--|-----------------------------|--------------------------------------|
| <b>Overmold:</b>        | TPU  | <b>Protection:</b>          | NEMA 1, 3, 4, 6P and IEC IP 67       |
| <b>Coupling Nut:</b>    | Nickel Plated CuZn or Stainless Steel (thread),<br>Nylon (snap lock) | <b>Rated Voltage:</b>       | 30 V                                 |
| <b>Contact Carrier:</b> | TPU or POM (Nylon)   | <b>Rated Current:</b>       | 3 A                                  |
| <b>Contacts:</b>        | Gold Plated CuZn   | <b>Ambient Temperature:</b> | -40 °C to +80 °C (-22 °F to +176 °F) |

1

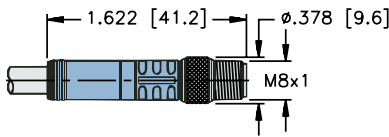

PSG 5M ..

Page M19

2

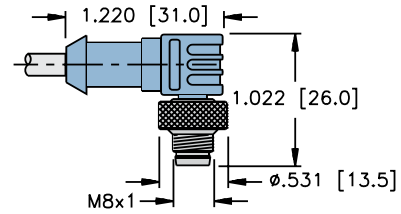

PSW 5M ..

Page M19

3

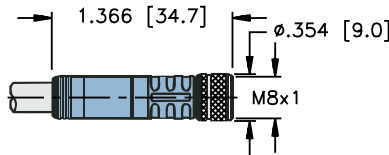

PKG 5M ..

Page M19

4

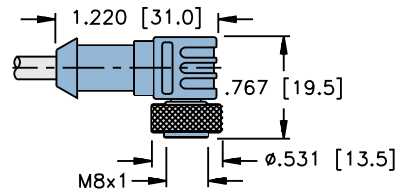

PKW 5M ..

Page M19

5

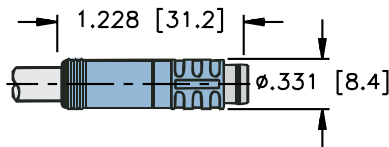

PSG 5 ..

Page M20

6

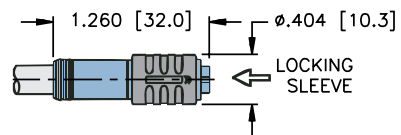

PKG 5Z ..

Page M20

We reserve the right to make technical alterations without prior notice.

DeviceNet™ Media

### Specifications

|                         |                                       |                             |                                      |
|-------------------------|---------------------------------------|-----------------------------|--------------------------------------|
| <b>Overmold:</b>        | TPU                                   | <b>Protection:</b>          | NEMA 1, 3, 4, 6P and IEC IP 68       |
| <b>Coupling Nut:</b>    | Nickel Plated CuZn or Stainless Steel | <b>Rated Voltage:</b>       | 250 V                                |
| <b>Contact Carrier:</b> | TPU                                   | <b>Rated Current:</b>       | 4 A                                  |
| <b>Contacts:</b>        | Gold Plated CuZn                      | <b>Ambient Temperature:</b> | -40 °C to +80 °C (-22 °F to +176 °F) |

7

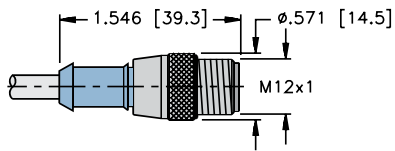

RST ..

Page M19

8

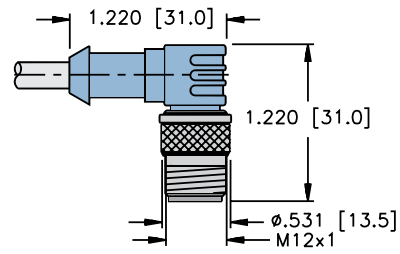

WST ..

Page M19

9

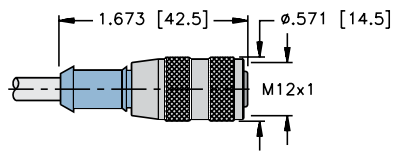

RKT ..

Page M19

10

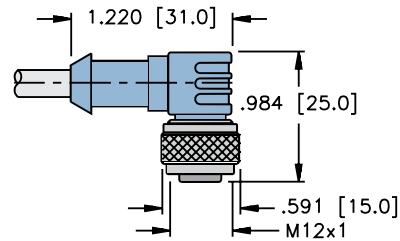

WKT ..

Page M19

We reserve the right to make technical alterations without prior notice.

DeviceNet, Terminating Resistors

- Terminating Resistors stabilize and minimize reflections on the Bus Line
- A Terminating Resistor is required at the beginning and end of the Main Bus Line



We reserve the right to make technical alterations without prior notice.

| Housing Style | Part Number   | Features  | Pinout               |
|---------------|---------------|---|----------------------|
|               | RSM 57-TR2    | Nickel plated brass or stainless steel, 300 V (7.6 V max. on pins with resistor), -40 °C to +80 °C, IP 67, 120 Ohms, 1/2 W internal resistance  | <p><b>Male</b></p>   |
|               | RKM 57-TR2    | Nickel plated brass or stainless steel, 300 V (7.6 V max. on pins with resistor), -40 °C to +80 °C, IP 67, 120 Ohms, 1/2 W internal resistance  | <p><b>Female</b></p> |
|               | RSM 57-TR2/VM | Nickel plated brass or stainless steel, 24 V (7.6 V max. on pins with resistor), -40 °C to +80 °C, IP 67, 120 Ohms, 1/2 W internal resistance, voltage monitoring<br><br>Led indication: Red - reverse polarity<br>Green - okay | <p><b>Male</b></p>   |
|               | RSE 57-TR2    | Nickel plated CuZn or stainless steel, 250 V (7.6 V max. on pins with resistor), 4 A, -40 °C to +80 °C, IP 68, 120 Ohms, 1/2 W internal resistance  | <p><b>Male</b></p>   |
|               | RKE 57-TR2    | Nickel plated CuZn or stainless steel, 250 V (7.6 V max. on pins with resistor), 4 A, -40 °C to +80 °C, IP 68, 120 Ohms, 1/2 W internal resistance  | <p><b>Female</b></p> |
|               | RSE 57-TR2/VM | Nickel plated CuZn or stainless steel, 10-30 VDC, -40 °C to +80 °C, IP 68, 120 Ohms, 1/2 W internal resistance, voltage monitoring<br><br>Led indication: Red - reverse polarity<br>Green - okay                                | <p><b>Female</b></p> |

DeviceNet™ Media

# DeviceNet™ Physical Media Connectivity

## DeviceNet, Terminating Resistors

- Terminating Resistors stabilize and minimize reflections on the Bus Line
- A Terminating Resistor is required at the beginning and end of the Main Bus Line



| Housing Style | Part Number  | Features   | Pinout            |
|---------------|--------------|--|-------------------|
|               | PSG 5M 57-TR | Nickel plated brass or stainless steel, 125 V(7.6 V max on resistor), 2 A, -40 °C to +105 °C, IP 67, male Picofast® connector, 120 Ohms, 1/2 W internal resistance | <b>Male</b><br>   |
|               | PKG 5M 57-TR |  | <b>Female</b><br> |

We reserve the right to make technical alterations without prior notice.

## DeviceNet, Receptacles

- Receptacles provide transition from Male to Female Connectors
- Available for Bulkhead and Feed Through applications



| Housing Style | Part Number          | Features  | Pinout |
|---------------|----------------------|---|--------|
|               | <b>RSF RKF 57/22</b> | Straight male/female feed through, nickel plated CuZn or stainless steel, 300 V, 9 A, -40 °C to +75 °C, IP 67 |        |
|               | <b>FKM FS 57/M12</b> | Straight male/female feed through, nickel plated CuZn or stainless steel, 150 V, 4 A, -40 °C to +75 °C, IP 67 |        |

Standard housing material is nickel plated brass. "RSF RKF.."; "RSFV RKFV.." indicates stainless steel housing.

We reserve the right to make technical alterations without prior notice.

DeviceNet™ Media

**Panel Cutout  
RSF RKF 57/22**

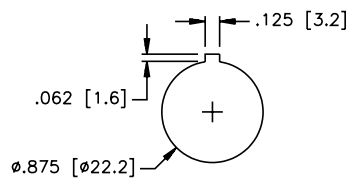

**Panel Cutout  
FKM FS 57/M12**

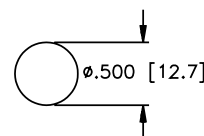

# DeviceNet™ Physical Media Connectivity

## DeviceNet, Eurofast® Drop Junctions

- Creates a Drop or Branch from the Main Bus Line
- Cable Drop Lengths available up to a maximum of 6 meters



| Housing Style | Part Number                      | Features   | Wiring Diagrams |
|---------------|----------------------------------|--|-----------------|
|               | <b>VB2-FKM/FKM/FSM 57</b>        | Ready for Eurofast drop and trunk cordsets, maximum six meter drop |                 |
|               | <b>VB2-RKC 57x-*/FKM FSM</b>     | Ready for Eurofast trunk line, maximum six meter drop              |                 |
|               | <b>VB2-FKM/RKC RSC 57x-*M-*M</b> | Ready for Eurofast drop cordsets, maximum six meter branch         |                 |

We reserve the right to make technical alterations without prior notice.

\* Indicates length in meters.  
 x Indicates cable type.



**Specifications**

|                         |                                       |                             |                                     |
|-------------------------|---------------------------------------|-----------------------------|-------------------------------------|
| <b>Overmold:</b>        | TPU                                   | <b>Protection:</b>          | NEMA 1, 3, 4, 6P and IEC IP 67      |
| <b>Coupling Nut:</b>    | Nickel Plated CuZn or Stainless Steel | <b>Rated Voltage:</b>       | 250 V                               |
| <b>Contact Carrier:</b> | TPU or POM (Nylon)                    | <b>Rated Current:</b>       | 4 A                                 |
| <b>Contacts:</b>        | Gold Plated CuZn                      | <b>Ambient Temperature:</b> | -40 °C to +75 °C (32 °F to +167 °F) |

Mounting: Mounting hole accepts #8 screw.

**VB2-FKM/FKM/FSM 57**

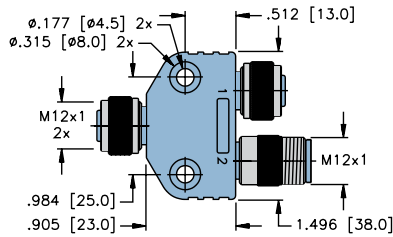

**VB2-RKC 57x-\*M-FKM FSM**

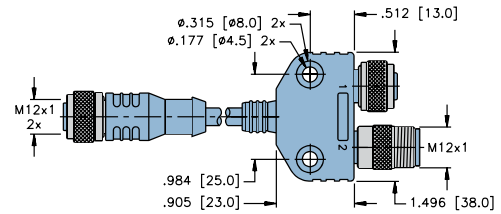

**VB2-FKM/FKM/FSM 57**

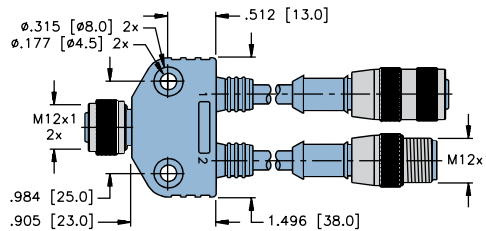

We reserve the right to make technical alterations without prior notice.

DeviceNet™ Media

**Pinouts**

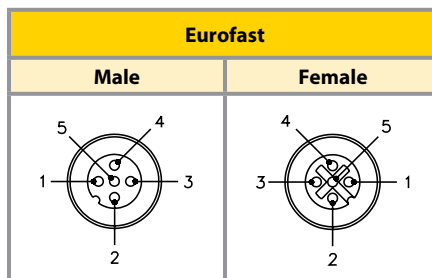

# DeviceNet™ Physical Media Connectivity

## DeviceNet, Bus Drop Tees

- Creates a Drop or Branch from the Main Bus Line
- (7/8-16 UN) Minifast® Connectors on Bus and Drop Lines
- Available in three Keyway options



| Housing Style | Part Number           | Features  | Wiring Diagrams |
|---------------|-----------------------|---|-----------------|
|               | <b>RSM-2RKM 57</b>    | TPU, 300 V, 9 A, -40 °C to +75 °C, maximum six meter branch, Standard keyway      |                 |
|               | <b>RSM 2RKM 57-KF</b> | TPU, 300 V, 9 A, -40 °C to +75 °C, maximum six meter branch, keyway facing female |                 |
|               | <b>RSM 2RKM 57-KM</b> | TPU, 300 V, 9 A, -40 °C to +75 °C, maximum six meter branch, keyway facing male   |                 |

We reserve the right to make technical alterations without prior notice.

### Pinouts

| Minifast |        |
|----------|--------|
| Male     | Female |
|          |        |

## DeviceNet, Bus Drop and Diagnostic Tee

- Creates a Drop or Branch from the Main Bus Line
- (7/8-16 UN) Minifast® Connectors on Bus and Drop Lines
- Available in three Keyway options
- Different genders available
- LED Status Indicator



| Housing Style | Part Number                 | Features   | Wiring Diagrams |
|---------------|-----------------------------|--|-----------------|
|               | <b>SH-RKM/RSM/RKM 57-VM</b> | TPU (Polyurethane), 30 V, 9 A, -40 °C to +105 °C, maximum six meter branch |                 |
|               | <b>RSM RSM 57-0/VM</b>      | TPU (Polyurethane), 30 V, 9 A, -40 °C to +105 °C, maximum six meter branch |                 |
|               | <b>RSM RKM 57-0/VM</b>      | TPU (Polyurethane), 30 V, 9 A, -40 °C to +105 °C, maximum six meter branch |                 |
|               | <b>RKM RKM 57-0/VM</b>      | TPU (Polyurethane), 30 V, 9 A, -40 °C to +105 °C                           |                 |

We reserve the right to make technical alterations without prior notice.

DeviceNet™ Media

### Pinouts

| Minifast |        |
|----------|--------|
| Male     | Female |
|          |        |

# DeviceNet™ Physical Media Connectivity

## DeviceNet, Bus Drop and Diagnostic Tee

- Creates a Drop or Branch from the Main Bus Line
- (7/8-16 UN) Minifast® Connectors on Bus and Drop Lines
- Available in three Keyway options
- Different genders available
- LED Status Indicator



| Housing Style | Part Number                             | Features  | Wiring Diagrams |
|---------------|---|---|-----------------|
|               | <p><b>MT-RKM/RSM/RKM 57/DNET/VM</b></p> |   |                 |
|               | <p><b>MT-RSM/2RKM 57/DNET/VM</b></p>    | <p>TPU (Polyurethane), 30 V,<br/>9 A, -40 °C to +105 °C</p> |                 |

We reserve the right to make technical alterations without prior notice.

## DeviceNet, Bus Drop Tee

- Creates a Drop or Branch from the Main Bus Line
- (7/8-16 UN) Minifast® Connectors on Bus and Drop Lines
- Available in three Keyway options
- Different genders available



| Housing Style | Part Number                | Features   | Wiring Diagrams |
|---------------|----------------------------|--|-----------------|
|               | <b>MT-RSM/2RKM 57/DNET</b> |  |                 |
|               | <b>XSH-RKM/RSM/RKM 57</b>  |  |                 |
|               | <b>XSH-RSM-2RKM 57</b>     | TPU (Polyurethane), 30 V, 9 A, -40 °C to +105 °C |                 |
|               | <b>RSM RSM 57-0</b>        |  |                 |
|               | <b>RKM RKM 57-0</b>        |  |                 |

We reserve the right to make technical alterations without prior notice.

DeviceNet™ Media

# DeviceNet™ Physical Media Connectivity

## DeviceNet, Power and Diagnostic Tees

- Provide a Drop to insert Power or Diagnostic Equipment
- (7/8-16 UN) Minifast® Connectors on Bus and Drop Lines
- Reverse Current Protection on Power Tap



| Housing Style | Part Number                  | Features  | Wiring Diagrams |
|---------------|------------------------------|---|-----------------|
|               | <b>RSM RKM 57 WSM 40 PST</b> | TPU, 300 V, 9 A, -40 °C to +75 °C, bus power tee provides segment power, includes reverse current protection  |                 |
|               | <b>RSM-2RKM 57 DGT</b>       | TPU, 300 V, 9 A, -40 °C to +75 °C, bus diagnostic tee provides easy connection for diagnostic tools, tap protected with cover when not in use (not shown) |                 |

We reserve the right to make technical alterations without prior notice.

### Pinouts

| Minifast |        |
|----------|--------|
| Male     | Female |
|          |        |

## DeviceNet, Bus Tees

- Creates a Drop or Branch from the Main Bus Line
- Cable Drop can be up to a maximum of 6 meters
- Eurofast® Drop Connector or Extension Cordset



| Housing Style | Part Number                  | Features  | Wiring Diagrams |
|---------------|------------------------------|---|-----------------|
|               | <b>RSM FKM RKM 57</b>        | TPU, 250 V, 4 A, -40 °C to +75 °C,<br>Minifast® to Eurofast bus power and data drop         |                 |
|               | <b>RSM RKC 57x-*M-RKM 57</b> | TPU, 250 V, 4 A, -40 °C to +75 °C,<br>Minifast to Eurofast cordset, bus power and data drop |                 |

We reserve the right to make technical alterations without prior notice.

DeviceNet™ Media

### Pinouts

| Minifast |        | Eurofast |
|----------|--------|----------|
| Male     | Female | Female   |
|          |        |          |

# DeviceNet™ Physical Media Connectivity

## DeviceNet, Eurofast® Bus Tees

- Creates a Drop or Branch from the Main Bus Line
- Cable Drop can be up to a maximum of 6 meters
- Eurofast Drop Connector



| Housing Style | Part Number                  | Features   | Wiring Diagrams |
|---------------|------------------------------|--|-----------------|
|               | <b>RSC 2RKC 57</b>           | TPU, 250 V, 4 A, -40 °C to +75 °C, Eurofast trunk and drop   |                 |
|               | <b>RSC 2RKC 57/KS</b>        | TPU, 250 V, 4 A, -40 °C to +75 °C, Eurofast trunk and drop, keyway aligns tee in-line on (M8x1) Piconet® boxes |                 |
|               | <b>RSC RKC 572-*M/RKC 57</b> | TPU, 32 V, 4 A (pins 2,3) 1 A (all others), -40 °C to +80 °C   |                 |

We reserve the right to make technical alterations without prior notice.

### Pinouts

| Eurofast |        |
|----------|--------|
| Male     | Female |
|          |        |



## DeviceNet, Gender Changers and Elbow Connectors

- Allows quick and easy changes from Male to Female Connectors
- Available in Straight and Right Angle Styles with Minifast® Connectors



| Housing Style | Part Number       | Features   | Wiring Diagrams |
|---------------|-------------------|--|-----------------|
|               | <b>RSM RSM 57</b> | TPU, 300 V, 9 A, -40 °C to +80 °C, changes female cordset to male cordset  |                 |
|               | <b>RKM RKM 57</b> | TPU, 300 V, 9 A, -40 °C to +80 °C, Changes male cordset to female cordset changes straight male or female cordset to right angle cordset |                 |
|               | <b>WSM RKM 57</b> | TPU, 300 V, 9 A, -40 °C to +80 °C, right angle male to female connector  |                 |

We reserve the right to make technical alterations without prior notice.

DeviceNet™ Media

### Pinouts

| Minifast |        |
|----------|--------|
| Male     | Female |
|          |        |

# DeviceNet™ Physical Media Connectivity

## DeviceNet, Gender Changers and Elbow Connectors

- Allows quick and easy changes from Male to Female and Minifast® to Eurofast® Connectors



| Housing Style | Part Number          | Features  | Wiring Diagrams |
|---------------|----------------------|---|-----------------|
|               | <b>RSM 57-FK 4.5</b> | Nickel plated CuZn or stainless steel, 250 V, 4 A, -40 °C to +75 °C, female Eurofast to male Minifast adapter |                 |
|               | <b>RSC RKC 57</b>    | Nickel plated CuZn, 250 V, 4 A, -40 °C to +105 °C, male Eurofast to female Eurofast adapter                   |                 |
|               | <b>RSC WKC 57</b>    |   |                 |

We reserve the right to make technical alterations without prior notice.

### Pinouts

| Minifast | Eurofast |        |
|----------|----------|--------|
| Male     | Male     | Female |
|          |          |        |

## DeviceNet, (7/8-16 UN) Minifast® Male Receptacles

- Provides quick connection to Field Devices or Enclosures
- Available for 1/2-14 NPT, 1/2-14 NPSM, 3/4-14 NPT and M20 Threads



| Housing Style                | Female Part Number     | Male Part Number       | Features   | Pinout               |
|------------------------------|------------------------|------------------------|--|----------------------|
| <p><b>RKF 57../14.5</b></p>  | <b>RKF 57-*M/14.5</b>  | <b>RSF 57-*M/14.5</b>  | Nickel plated CuZn or stainless steel, 300 V, 9 A, -40 °C to +105 °C, 1/2-14 NPT full length threads | <p><b>Female</b></p> |
| <p><b>RSF 57../14.5</b></p>  |                        |                        |  |                      |
| <p><b>RKF 57../14.75</b></p> | <b>RKF 57-*M/14.75</b> | <b>RSF 57-*M/14.75</b> | Nickel plated CuZn or stainless steel, 300 V, 9 A, -40 °C to +105 °C, 3/4-14 NPT full length threads | <p><b>Male</b></p>   |
| <p><b>RSF 57../14.75</b></p> |                        |                        |  |                      |
| <p><b>RKF 57../M20</b></p>   | <b>RKF 57-*M/M20</b>   | <b>RSF 57-*M/M20</b>   | Nickel plated CuZn or stainless steel, 300 V, 9 A, -40 °C to +105 °C, M20x1.5 threads                |                      |
| <p><b>RSF 57../M20</b></p>   |                        |                        |  |                      |

We reserve the right to make technical alterations without prior notice.

DeviceNet™ Media

\* Length in meters.  
 Standard cable length is 0.5 meters. Consult factory for other lengths.  
 Standard housing material is nickel plated brass. "RKF .."; "RKFV .." indicates 316 stainless steel housing.  
 For locknuts to be included, add "W/LN" to the end of the part number.

# DeviceNet™ Physical Media Connectivity

## DeviceNet, (7/8-16 UN) Minifast® Male Receptacles

- Provides quick connection to Field Devices or Enclosures
- Available for 1/2-14 NPT, 1/2-14 NPSM, 3/4-14 NPT and M20 Threads



| Housing Style          | Female Part Number | Male Part Number | Features  | Pinout               |
|------------------------|--------------------|------------------|---|----------------------|
| <p><b>RKF 57..</b></p> | RKF 57-*M          | RSF 57-*M        | Nickel plated CuZn or stainless steel, 300 V, 9 A, -40 °C to +105 °C, 1/2-14 NPSM threads | <p><b>Female</b></p> |
| <p><b>RSF 57..</b></p> |                    |                  |   | <p><b>Male</b></p>   |

\* Length in meters.  
 Standard cable length is 0.5 meters. Consult factory for other lengths.  
 Standard housing material is nickel plated brass. "RKF .."; "RKFV .." indicates 316 stainless steel housing.  
 For locknuts to be included, add "W/LN" to the end of the part number.

We reserve the right to make technical alterations without prior notice.

## DeviceNet, (M12x1) Eurofast® Male Receptacles

- Provides quick connection to Field Devices
- Available for 1/2-14 NPT, 1/2-14 NPSM, 3/4-14 NPT and M20 Threads



We reserve the right to make technical alterations without prior notice.

| Housing Style               | Female Part Number    | Male Part Number      | Features   | Pinout   |
|-----------------------------|-----------------------|-----------------------|--|--|
| <p><b>FK 57../14.5</b></p>  | <b>FK 57-*M/14.5</b>  | <b>FS 57-*M/14.5</b>  | Nickel plated CuZn or stainless steel, 250 V, 4 A, -40 °C to +105 °C, 1/2-14 NPT full length threads |  |
| <p><b>FS 57../14.5</b></p>  |                       |                       |  |  |
| <p><b>FK 57../14.75</b></p> | <b>FK 57-*M/14.75</b> | <b>FS 57-*M/14.75</b> | Nickel plated CuZn or stainless steel, 250 V, 4 A, -40 °C to +105 °C, 3/4-14 NPT full length threads | <ol style="list-style-type: none"> <li>GY</li> <li>RD</li> <li>BK</li> <li>WH</li> <li>BU</li> </ol> |
| <p><b>FS 57../14.75</b></p> |                       |                       |  |  |
| <p><b>FK 57.../M20</b></p>  | <b>FK 57-*M/M20</b>   | <b>FS 57-*M/M20</b>   | Nickel plated CuZn or stainless steel, 250 V, 4 A, -40 °C to +105 °C, M20x1.5 threads                |  |
| <p><b>FS 57.../M20</b></p>  |                       |                       |  |  |

\* Length in meters.  
 Standard cable length is 0.5 meters. Consult factory for other lengths.  
 Standard housing material is nickel plated brass. "RKF .."; "RKFV .." indicates 316 stainless steel housing.

# DeviceNet™ Physical Media Connectivity

## DeviceNet, (M12x1) Eurofast® Male Receptacles

- Provides quick connection to Field Devices
- Available for 1/2-14 NPT, 1/2-14 NPSM, 3/4-14 NPT and M20 Threads



| Housing Style                                | Female Part Number | Male Part Number | Features   | Pinout                                  |
|--|--------------------|------------------|--|---|
| <p><b>FK 57...</b></p> <p><b>FS 57..</b></p> | <b>FK 57-*M</b>    | <b>FS 57-*M</b>  | Nickel plated CuZn or stainless steel, 250 V, 4 A, -40 °C to +105 °C, PG 9 threads | <p><b>Female</b></p> <p><b>Male</b></p> |

\* Length in meters.  
 Standard cable length is 0.5 meters. Consult factory for other lengths.  
 Standard housing material is nickel plated brass. "RKF .."; "RKFV .." indicates 316 stainless steel housing.

We reserve the right to make technical alterations without prior notice.

## DeviceNet, Minifast® PCB and Solder Cup Receptacles

- Provides (7/8-16 UN) Minifast connection to Field Devices



| Housing Style            | Female Part Number | Male Part Number  | Features   | Pinout |
|--------------------------|--------------------|-------------------|--|--------|
| <p><b>RKF 57 PCB</b></p> | <b>RKF 57-PCB</b>  | <b>RSF 57-PCB</b> | Nickel plated CuZn or stainless steel, 300 V, 9 A, -40 °C to +105 °C, Minifast PCB pins    |        |
| <p><b>RSF 57 PCB</b></p> |                    |                   |  |        |
| <p><b>RKF 57</b></p>     | <b>RKF 57</b>      | <b>RSF 57</b>     | Nickel plated CuZn or stainless steel, 300 V, 9 A, -40 °C to +105 °C, Minifast solder cups |        |
| <p><b>RSF 57</b></p>     |                    |                   |  |        |

We reserve the right to make technical alterations without prior notice.

DeviceNet™ Media

Standard housing material is nickel plated brass "RSFV .."; "RKFV .." indicates 316 stainless steel.

### Board Layout (reference only) FK ... FS

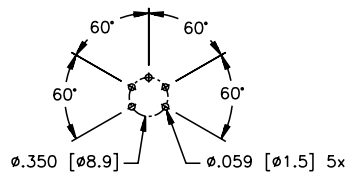

### Panel Cutout FK ... FS

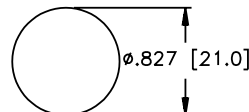

# DeviceNet™ Physical Media Connectivity

## DeviceNet, Eurofast® PCB and Solder Cup Receptacles

- Provides (M12x1) Eurofast Connection to Field Devices



| Housing Style               | Female Part Number   | Male Part Number     | Features  | Pinout               |
|-----------------------------|----------------------|----------------------|---|----------------------|
| <p><b>FK 57-PCB KIT</b></p> | <b>FK 57-PCB KIT</b> | <b>FS 57-PCB KIT</b> | Nickel plated CuZn or stainless steel, 250 V, 4 A, -40 °C to +105 °C, male Eurofast with mounting kit | <p><b>Male</b></p>   |
| <p><b>FS 57-PCB KIT</b></p> |                      |                      |   |                      |
| <p><b>FS 57-PCB</b></p>     | <b>FK 57-PCB</b>     | <b>FS 57-PCB</b>     | Nickel plated CuZn or stainless steel, 250 V, 4 A, -40 °C to +105 °C, male Eurofast                   | <p><b>Female</b></p> |
| <p><b>FK 57-PCB</b></p>     |                      |                      |   |                      |

We reserve the right to make technical alterations without prior notice.

Standard housing material is nickel plated brass "FSV .."; "FKV .." indicates 316 stainless steel.

### Board Layout (reference only) FK ... FS

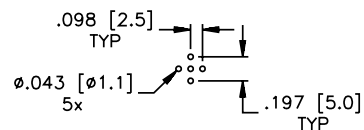



## DeviceNet, Eurofast® PCB Pins and Solder Cup Receptacles

- Provides (M12x1) Eurofast Connection to Field Devices



| Housing Style             | Female Part Number | Male Part Number   | Features   | Pinout  |
|---------------------------|--------------------|--------------------|--|---|
| <p><b>FKFD 57 PCB</b></p> | <b>FKFD 57-PCB</b> | <b>FSFD 57-PCB</b> | Nickel plated CuZn or stainless steel, 250 V, 4 A, -40 °C to +105 °C, male Eurofast PCB pins             | <p><b>Female</b></p>  |
| <p><b>FSFD 57 PCB</b></p> |                    |                    |  |   |
| <p><b>FKFDL 57</b></p>    | <b>FKFDL 57</b>    | <b>FSFDL 57</b>    | Nickel plated CuZn or stainless steel, 250 V, 4 A, -40 °C to +105 °C, male Eurofast solder cups          | <ol style="list-style-type: none"> <li>1. BARE</li> <li>2. RD</li> <li>3. BK</li> <li>4. WH</li> <li>5. BU</li> </ol> |
| <p><b>FSFDL 57</b></p>    |                    |                    |  |   |
| <p><b>WFS 57 PCB</b></p>  |                    | <b>WFS 57-PCB</b>  | Nickel plated CuZn or stainless steel, 250 V, 4 A, -40 °C to +105 °C, male Eurofast right angle PCB pins | <p><b>Male</b></p>  |
|                           |                    |                    |  |   |

We reserve the right to make technical alterations without prior notice.

DeviceNet™ Media

Standard housing material is nickel plated brass "FKFD .."; "FKFDV .." indicates 316 stainless steel.

### Panel Cutout FKFD ... FSFD

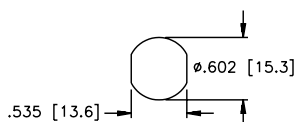

### Board Layout (reference only) FKFD ... FSFD

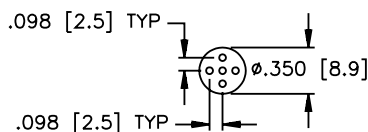

### Panel Cutout WFS

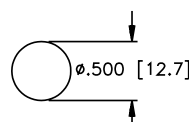

### Board Layout (reference only) WFS

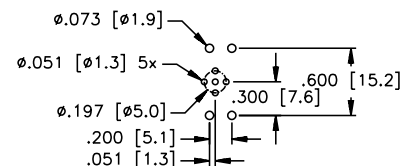

# DeviceNet™ Physical Media Connectivity

## DeviceNet, Minifast® Field Wireable Connectors

- Allows for quick connection when Pre-Molded Cables not available
- Available for Male and Female connectors
- Color Coded Wire Connections for DeviceNet



| Housing Style           | Female Part Number        | Male Part Number           | Features   | Pinout               |
|-------------------------|---------------------------|----------------------------|--|----------------------|
| <p><b>B 4151..</b></p>  | <b>B 4151-0/9/DNET</b>    | <b>BS 4151-0/9/DNET</b>    | Glass filled nylon, PG 9 cable gland, accepts 6-8 mm cable diameter, screw terminals, 85 °C, 250 V, 9 A, mates with all 5-pin cordsets and receptacles     | <p><b>Female</b></p> |
| <p><b>BS 4151..</b></p> | <b>B 4251-0/9/DNET</b>    | <b>BS 4251-0/9/DNET</b>    | Glass filled nylon, PG 9 cable gland, accepts 6-8 mm cable diameter, screw terminals, 85 °C, 250 V, 9 A, mates with all 5-pin cordsets and receptacles     |                      |
| <p><b>B 4251..</b></p>  | <b>B 4151-0/13.5/DNET</b> | <b>BS 4151-0/13.5/DNET</b> | Glass filled nylon, PG 13.5 cable gland, accepts 10-12 mm cable diameter, screw terminals 85 °C, 250 V, 9 A, mates with all 5-pin cordsets and receptacles | <p><b>Male</b></p>   |
| <p><b>BS 4251..</b></p> | <b>B 4151-0/16/DNET</b>   | <b>BS 4151-0/16/DNET</b>   | Glass filled nylon, PG 16 cable gland, accepts 12-14 mm cable diameter, screw terminals 85 °C, 250 V, 9 A, mates with all 5-pin cordsets and receptacles   |                      |

We reserve the right to make technical alterations without prior notice.

## DeviceNet, Eurofast® Field Wireable Connectors

- Allows for quick connection when Pre-Molded Cables not available
- Available for Male and Female connectors in Straight or Right-Angle configurations
- Color Coded Wire Connections for DeviceNet



| Housing Style          | Female Part Number       | Male Part Number          | Features   | Pinout   |                    |
|------------------------|--------------------------|---------------------------|--|--|--------------------|
| <p><b>B 81...</b></p>  | <b>B 8151-0/PG9/DNET</b> | <b>BS 8151-0/PG9/DNET</b> | PBT, Black, PG 9 cable gland, accepts 4-8 mm cable diameter, screw terminals, 85 °C, 125 V, 4 A, mates with 5-pin cordsets and receptacles | <p><b>Female</b></p>   |                    |
| <p><b>BS 81...</b></p> |                          |                           |  |  |                    |
| <p><b>B 82...</b></p>  | <b>B 8251-0/PG9/DNET</b> | <b>BS 8251-0/PG9/DNET</b> |  | PBT, Black, PG 9 cable gland, accepts 4-8 mm cable diameter, screw terminals, 85 °C, 125 V, 4 A, mates with 5-pin cordsets and receptacles | <p><b>Male</b></p> |
| <p><b>BS 82...</b></p> |                          |                           |  |  |                    |

We reserve the right to make technical alterations without prior notice.

DeviceNet™ Media

# DeviceNet™ Physical Media Connectivity

## DeviceNet, Eurofast® Daisy Chain Configurations

- Multi-drop Harnesses designed for OEM applications
- Provides cost effective solution vs. Single Tees and Drops



| Part Number             | Features   |
|-------------------------|--|
| FSFD 2VBWK WKC 5724-DCL | TPU, 250 V, 4 A, -40 °C to +75 °C, available in custom configurations including length, number of drops and end connector styles |

Consult factory for other designs.

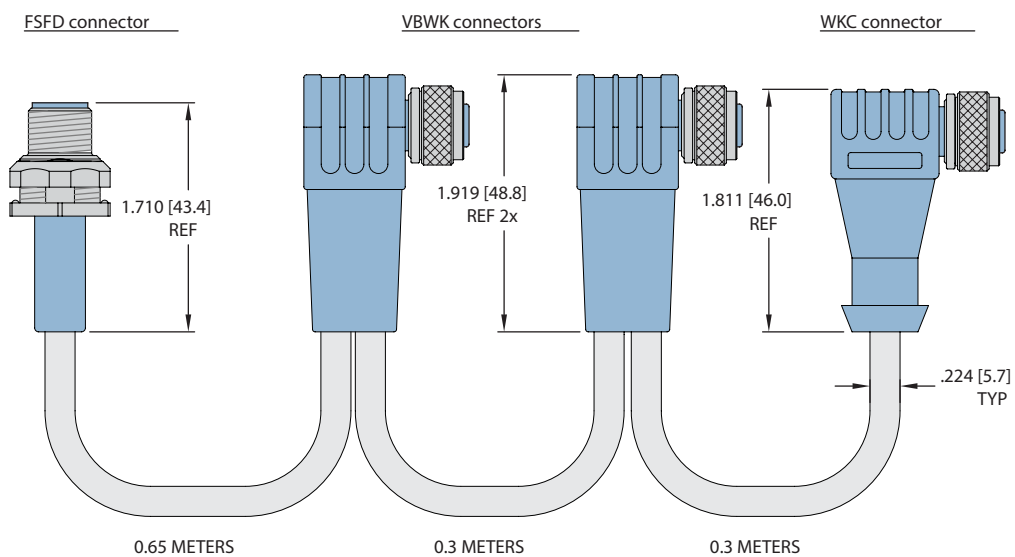

We reserve the right to make technical alterations without prior notice.

### Pinouts

| Eurofast |        |
|----------|--------|
| Male     | Female |
|          |        |

## DeviceNet, Eurofast® Daisy Chain Configurations

- Multi-drop Harnesses designed for OEM applications
- Provides cost effective solution vs. Single Tees and Drops



| Part Number            | Features   |
|------------------------|--|
| RSC 8VBRK RKC 5724-DCL | TPU, 250 V, 4 A, -40 °C to +75 °C, available in custom configurations including length, number of drops and end connector styles |

Consult factory for other designs.

We reserve the right to make technical alterations without prior notice.

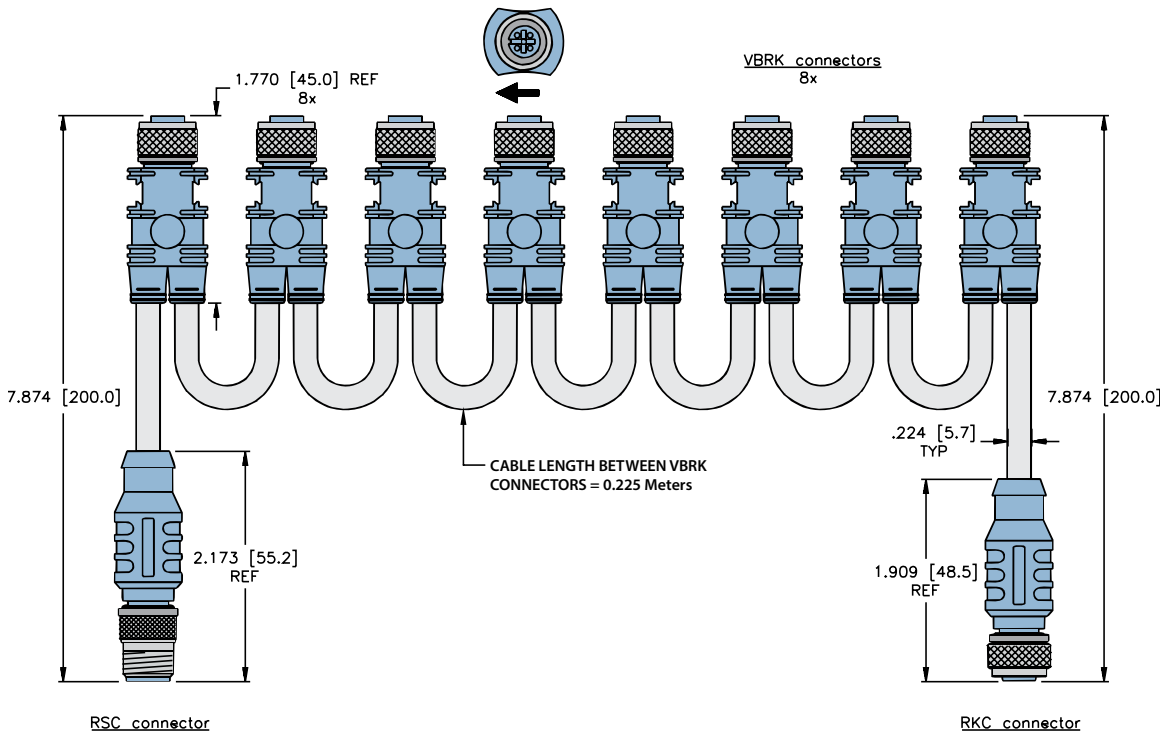

DeviceNet™ Media

### Pinouts

| Eurofast |        |
|----------|--------|
| Male     | Female |
|          |        |

# DeviceNet™ Physical Media Connectivity

## Conduit Adapters

- Converts Standard Conduits to Quick Disconnect
- Fiberglass Reinforced Nylon Housings
- Nickel Plated Brass Connectors available
- Gasket and Mounting Screws provided
- IP67



| Housing Style | 1-Port Part Number | 2-Port Part Number | Specifications   | Pinout               |
|---------------|--------------------|--------------------|--|----------------------|
|               | BCA-57-E123        | BCA-57-E223        | 3/4" Form 8 or Mark 9 conduit to M12x1 adapter, -30 °C to +80 °C (-22 °F to +176 °F) | <p><b>Female</b></p> |
|               | BCA-57-M123        | BCA-57-M223        | 3/4" Form 8 or Mark 9 conduit to 7/8"-16 UN, -40 °C to +75 °C (-40 °F to +167 °F)    | <p><b>Female</b></p> |
|               | BCA1-F7-57-M123    | BCA1-F7-57-M223    | 1" Form 7 conduit adapter, -40 °C to +75 °C (-40 °F to +167 °F)                      | <p><b>Female</b></p> |

We reserve the right to make technical alterations without prior notice.

## Wall Plate Adapters

- Attaches to Standard Single Gang Electrical Box
- Stainless Steel with Stainless Steel Connectors
- Gasket and Mounting Screws provided
- IP67



| Housing Style | M12x1 Part Number | 7/8-16UN Part Number | Specifications                                   | Pinout               |
|---------------|-------------------|----------------------|--|----------------------|
|               | BCA-57-E123       | BCA-57-E223          | IP67 rated, -40 °C to +75 °C (-40 °F to +167 °F) | <p><b>Female</b></p> |
|               |                   |                      |  | <p><b>Female</b></p> |

|                         |            |
|-------------------------|------------|
| <b>Part Number Keys</b> | <b>N4</b>  |
| <b>Cordsets</b>         | <b>N8</b>  |
| <b>Tees</b>             | <b>N13</b> |
| <b>Receptacles</b>      | <b>N17</b> |
| <b>Field Wireables</b>  | <b>N21</b> |

**Features**

- Cables that meet the requirements of Foundation fieldbus FF-844 Type A Cable
- ITC/PLTC listed cable (CSA FT4)
- Expose Run (ER) and Direct Buried (DB) listed cable
- Oil resistant II and sunlight resistant
- 7/8 and M12 connectors
- Up to 9 Amps and 600 Volt rated
- IP67/IP69K rated



## FOUNDATION fieldbus General Specifications

FOUNDATION fieldbus is a communication protocol and physical method to interconnect smart devices such as temperature transmitters, pressure transmitters and valve actuators. The physical layer conforms to ISA SP50.02 and IEC 1158-2 standards for fieldbuses.

Fieldbus technology allows many smart devices to share one communication medium. The digital communication signal is superimposed onto a DC carrier. This reduces the amount of terminations to connect all the field devices to a host system and allows greater flexibility for future additions of I/O points.

A FOUNDATION fieldbus device is addressable and can store and transmit data. The devices can store values, track changes and use pre-set alarms to trigger. Based on pre-defined tag names, host systems can read transmitter values such as temperature and pressure to set values of a valve actuator.

Digital signal encoding is done using Manchester BiPhase-L and error checking is done with the CRC method. FOUNDATION fieldbus has two types of devices - A Basic Device (BD) which reads inputs, track values and set outputs if programmed to do so, and a Link Active Scheduler (LAS) which performs the same features as a BD and handles network communication timing between all the active devices on the network.



## Topology

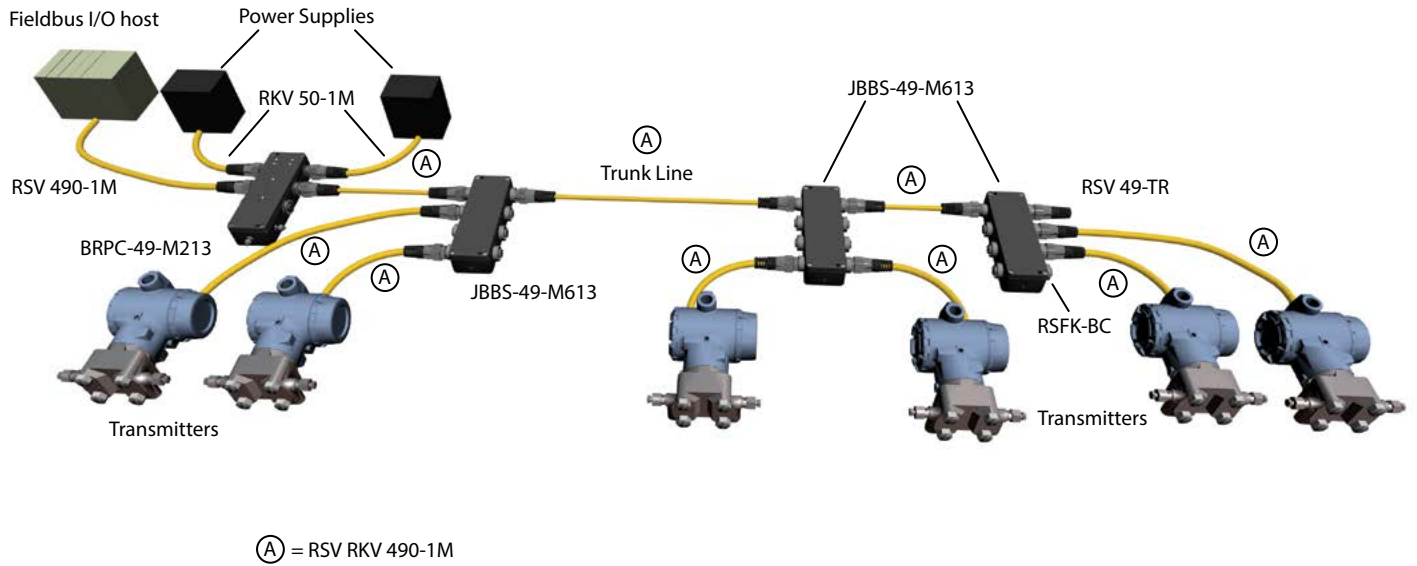

# FOUNDATION™ fieldbus Physical Media Connectivity

## Minifast® Cordset Part Number Key

Part Number Keys are to assist in IDENTIFICATION ONLY. Consult factory for catalog items not identified.

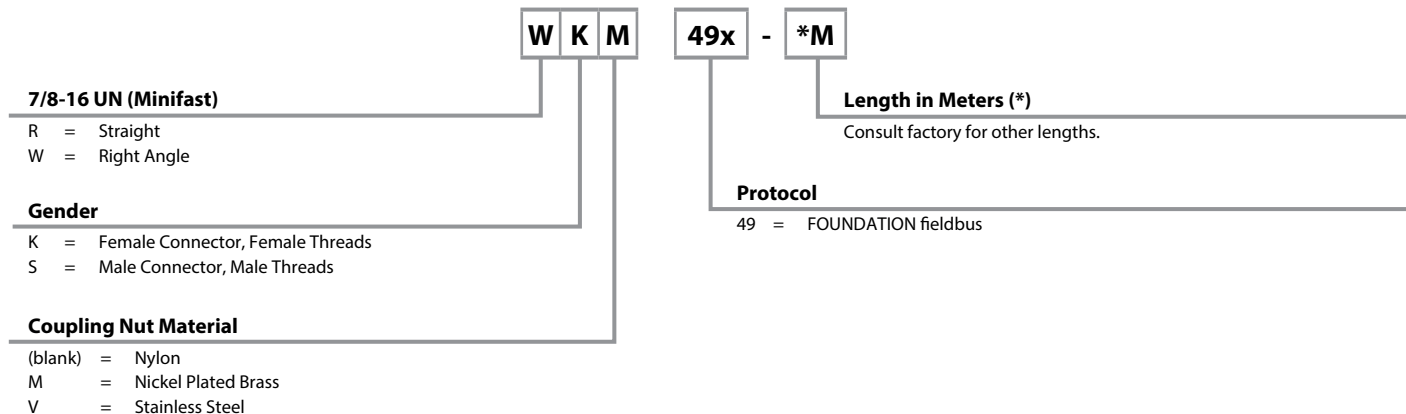

## Minifast Receptacle Part Number Key

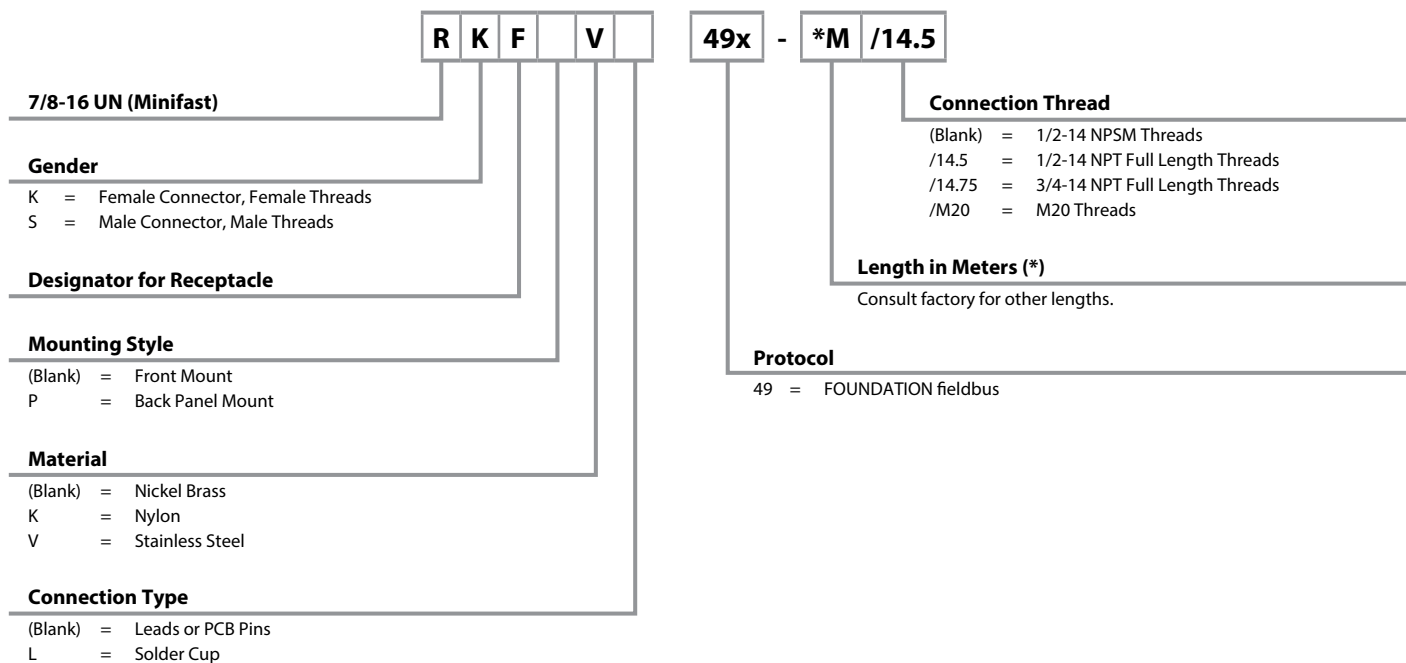

## Eurofast® Cordset Part Number Key

Part Number Keys are to assist in IDENTIFICATION ONLY. Consult factory for catalog items not identified.

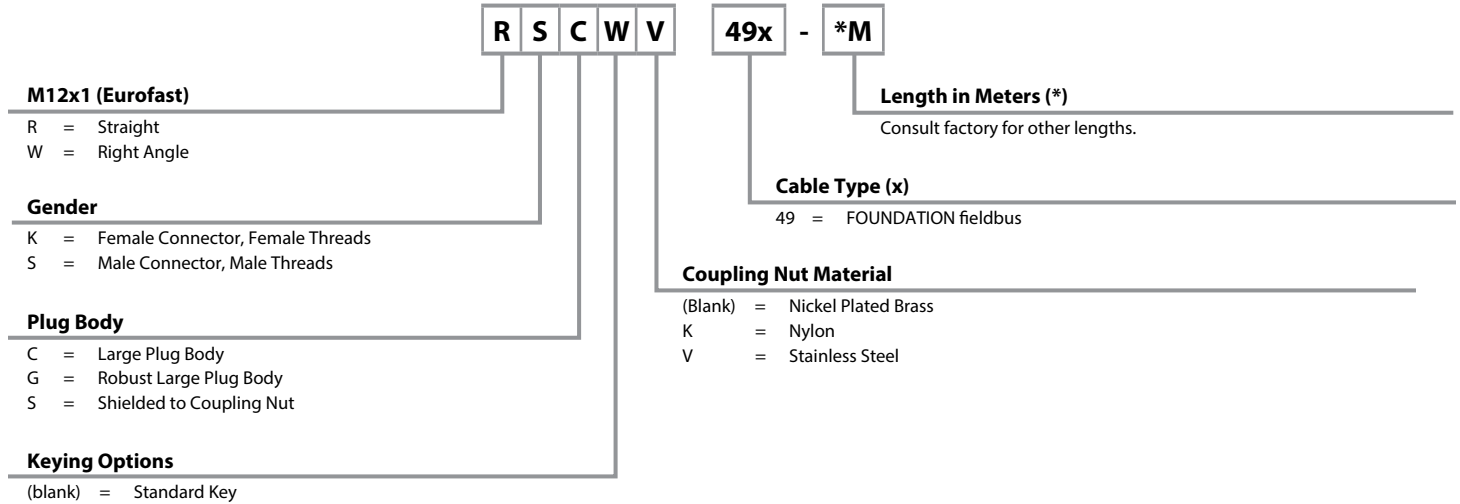

## Eurofast Receptacle Part Number Key

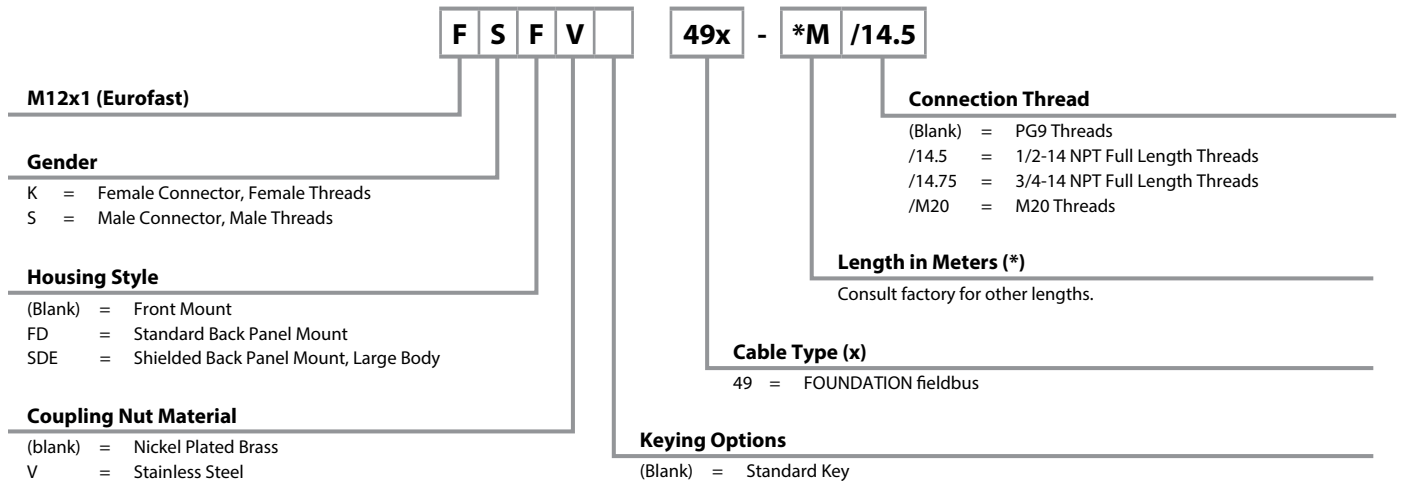

# FOUNDATION™ fieldbus Physical Media Connectivity

## Cable Specifications (with ground)

- Cables are compliant with FOUNDATION fieldbus FF-844 Cable Specification for Type A cable, IEC 61158-2 and ISA/SP50
- Cables are available in 3-wire versions with a Device Ground or 2-wire versions

### Type A Cable Specifications

- Temperature range: -40 °C to +105 °C
- UV Resistant and Oil Resistant
- PLTC and ITC Listed (CSA FT1, FT4)
- Exposed Run (ER) and Direct Buried (DB) Listed
- Maximum Attenuation at 1.25 f<sub>r</sub> (39 kHz) = 3.0 dB/km
- Characteristic Impedance 100 Ω ± 10 Ω @ 31.25 KHz
- Capacitance: 20 pF/Ft nominal
- Inductance: 0.22 μH/Ft. nominal

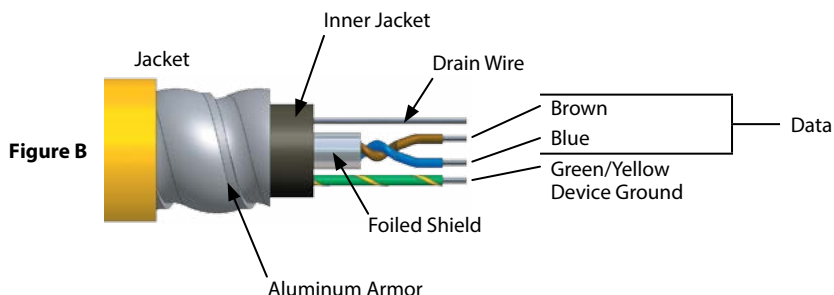
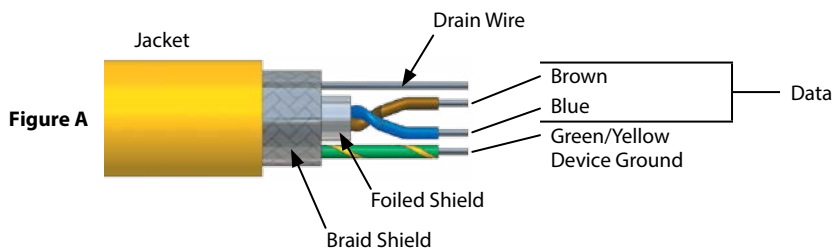

| Type                          | Approvals                                 | Data Pair      |                             | Device Ground  | Outer Jacket                   | Shields            | Bulk Cable Part Number / Weight/300 M |
|-------------------------------|---|----------------|-----------------------------|----------------|--------------------------------|--------------------|---------------------------------------|
|                               |   | AWG Color Code | DCR (/1000 feet) Insulation | AWG Color Code | Material Color Nominal O.D.    | Type Drain Wire    |                                       |
| <b>490</b><br>105 °C, 600 V   | c(UL) 1309 MS, ITC-ER DB, CIC/TC, FT1 FT4 | 2X18 AWG BU/BN | 7.06 Ohms XLPE              | 18 AWG, GN-YE  | PVC, YELLOW, 8.4 mm (.330 in)  | Foil, 20 AWG       | RB50693-*M, 66 lbs.                   |
| <b>490B</b><br>105 °C, 600 V  | c(UL) 1309 MS, ITC-ER DB, CIC/TC, FT1 FT4 | 2X18 AWG BU/BN | 7.06 Ohms XLPE              | 18 AWG, GN-YE  | PVC, BLUE, 8.4 mm (.330 in)    | Foil, 20 AWG       | B50783-*M, 66 lbs.                    |
| <b>492A</b><br>105 °C, 300 V  | UL ITC-ER DB, CSA ACIC HL-ABCD, FT1 FT4   | 2X18 AWG BU/BN | 7.06 Ohms XLPE              | 18 AWG, GN-YE  | PVC, YELLOW, 15.6 mm (.615 in) | Foil/armor, 20 AWG | RB50874-*M, 184 lbs.                  |
| <b>492BA</b><br>105 °C, 300 V | UL ITC-ER DB, CSA ACIC HL-ABCD, FT1 FT4   | 2X18 AWG BU/BN | 7.06 Ohms XLPE              | 18 AWG, GN-YE  | PVC, BLUE, 15.6 mm (.615 in)   | Foil/armor, 20 AWG | RB50803-*M, 184 lbs.                  |

\* Indicates length in meters.  
Standard cable spool lengths are 30, 75, 100, 150, 200, 225 and 300 meters.

We reserve the right to make technical alterations without prior notice.

Cable Specifications (without ground)

- Cable that Meets the Requirements of ISA/SP50 and FOUNDATION™ fieldbus Requirements for Type A Cable
- Cables are available in 3-wire versions with a Device Ground or 2-wire versions

Type A Cable Specifications

- Temperature range: -40 °C to +105 °C
- UV Resistant and Oil Resistant
- PLTC and ITC Listed (CSA FT1, FT4)
- Exposed Run (ER) and Direct Buried (DB) Listed
- Maximum Attenuation at 1.25 f, (39 kHz) = 3.0 dB/km
- Characteristic Impedence 100 Ω ± 10 Ω @ 31.25 KHz
- Capacitance: 20 pF/Ft nominal
- Inductance: 0.22 μH/Ft. nominal

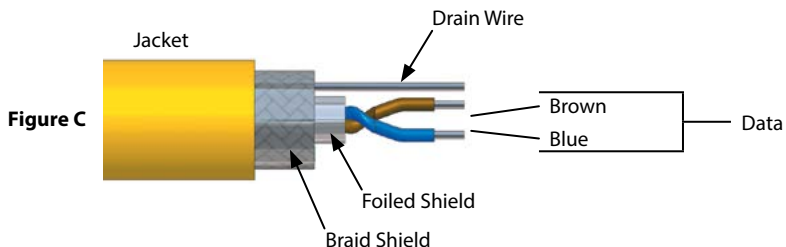

We reserve the right to make technical alterations without prior notice.









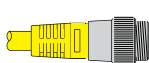
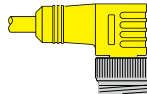

| Type                          | Approvals                                    | Data Pair         |                                   | Outer Jacket                     | Shields            | Bulk Cable Part Number/<br>Weight/300 M |
|-------------------------------|--|-------------------|-----------------------------------|----------------------------------|--------------------|---|
|                               |  | AWG<br>Color Code | DCR<br>(/1000 feet)<br>Insulation |                                  |                    |   |
| <b>493</b><br>105 °C, 600 V   | c(UL) 1309 MS, ITC-ER DB,<br>CIC/TC, FT1 FT4 | 2X18 AWG<br>BU/BN | 7.06 Ohms<br>XLPE                 | PVC, YELLOW,<br>8.5 mm (.335 in) | Foil/braid, 20 AWG | RB50784-*M,<br>66 lbs.                  |
| <b>493B</b><br>105 °C, 600 V  | c(UL) 1309 MS, ITC-ER DB,<br>CIC/TC, FT1 FT4 | 2X18 AWG<br>BU/BN | 7.06 Ohms<br>XLPE                 | PVC, BLUE,<br>8.5 mm (.335 in)   | Foil/braid, 20 AWG | RB50786-*M,<br>66 lbs.                  |
| <b>493O</b><br>105 °C, 600 V  | c(UL) 1309 MS, ITC-ER DB,<br>CIC/TC, FT1 FT4 | 2X18 AWG<br>BU/BN | 7.06 Ohms<br>XLPE                 | PVC, ORANGE,<br>8.5 mm (.335 in) | Foil/braid, 20 AWG | RB50785-*M,<br>66 lbs.                  |
| <b>496</b><br>105 °C, 600 V   | c(UL) 1309 MS, ITC-ER DB,<br>CIC/TC, FT1 FT4 | 2X16 AWG<br>BU/BN | 4.05 Ohms<br>XLPE                 | PVC, YELLOW,<br>9.1 mm (.360 in) | Foil, 18 AWG       | RB50891-*M,<br>69 lbs.                  |
| <b>496BK</b><br>105 °C, 600 V | c(UL) 1309 MS, ITC-ER DB,<br>CIC/TC, FT1 FT4 | 2X16 AWG<br>BU/BN | 4.05 Ohms<br>XLPE                 | PVC, BLACK,<br>9.1 mm (.360 in)  | Foil, 18 AWG       | RB51300-*M,<br>69 lbs.                  |

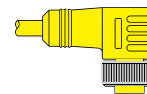
\* Indicates length in meters.  
Standard cable pool lengths are 30, 75, 100, 150, 200, 225 and 300 meters.

FOUNDATION™ fieldbus

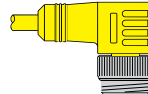
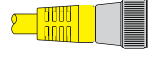
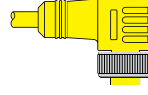
# FOUNDATION™ fieldbus Physical Media Connectivity

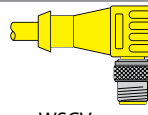
## Cable and Cordset Selection Matrix

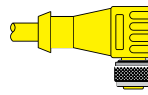
|                   |   | Minifast®  |  |  |  | Eurofast®   |
|-------------------|---|--|--|--|--|---|
|                   |   | (Male)   |  | (Female)   |  | Male  |
|                   |   | 1 <br>RSV | 2 <br>WSV | 3 <br>RKV | 4 <br>WKV | 7 <br>RSCV |
|                   | <br>Bare       | RSV 49x-*M   | WSV 49x-*M   | RKV 49x-*M   | WKV 49x-*M   | RSCV 49x-*M   |
| Minifast (Male)   | 1 <br>RSV      | RSV RSV 49x-*M   | RSV WSV 49x-*M   | RSV RKV 49x-*M   | RSV WKV 49x-*M   | RSV RSCV 49x-*M   |
|                   | 2 <br>WSV      |  | WSV WSV 49x-*M   | WSV RKV 49x-*M   | WSV WKV 49x-*M   | WSV RSCV 49x-*M   |
| Minifast (Female) | 3 <br>RKV      |  |  | RKV RKV 49x-*M   | RKV WKV 49x-*M   | RKV RSCV 49x-*M   |
|                   | 4 <br>WKV     |  |  |  | WKV WKV 49x-*M   | WKV RSCV 49x-*M   |
| Eurofast (Male)   | 7 <br>RSCV   |  |  |  |  | RSCV RSCV 49x-*M  |
|                   | 8 <br>WSCV   |  |  |  |  |   |
| Eurofast (Female) | 9 <br>RKCV   |  |  |  |  |   |
|                   | 10 <br>WKCVC |  |  |  |  |   |

We reserve the right to make technical alterations without prior notice.

See pages N10 - N11 for dimensional drawings.

\* Indicates length in meters.

x Indicates cable type.

Standard cable lengths are 1, 2, 4, 6, 8, 10, 15...50 Meters. Consult factory for other lengths.

For stainless steel coupling nuts change part number RSM ... to RSV, WSM ... to WSV.

Cable and Cordset Selection Matrix

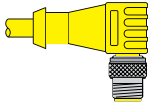
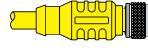
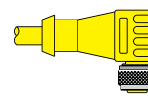
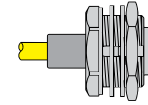
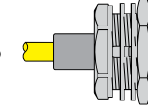
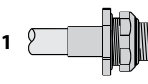
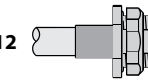
| Eurofast®   |   |  | Minifast® Bulkhead  |  | Eurofast Bulkhead  |  |
|---|---|--|---|--|--|--|
| Male  | Female  |  | Male  | Female   | Male   | Female   |
| 8  | 9  | 10  | 5  | 6  | 11  | 12  |
| WSCV  | RKCV  | WKCV   | RSFPV   | RKFPV  | FSFDV  | FKFDV  |
| WSCV 49x-*M   | RKCV 49x-*M   | WKCV 49x-*M  | RSFPV 49x-*M  | RKFPV 49x-*M   | FSFDV 49x-*M   | FKFDV 49x-*M   |
| RSV WSCV 49x-*M   | RSV RKCV 49x-*M   | RSV WKCV 49x-*M  | RSV RSFPV 49x-*M  | RSV RKFPV 49x-*M   | RSV FSFDV 49x-*M   | RSV FKFDV 49x-*M   |
| WSV WSCV 49x-*M   | WSV RKCV 49x-*M   | WSV WKCV 49x-*M  | WSV RSFPV 49x-*M  | WSV RKFPV 49x-*M   | WSV FSFDV 49x-*M   | WSV FKFDV 49x-*M   |
| RKV WSCV 49x-*M   | RKV RKCV 49x-*M   | RKV WKCV 49x-*M  | RKV RSFPV 49x-*M  | RKV RKFPV 49x-*M   | RKV FSFDV 49x-*M   | RKV FKFDV 49x-*M   |
| WKV WSCV 49x-*M   | WKV RKCV 49x-*M   | WKV WKCV 49x-*M  | WKV RSFPV 49x-*M  | WKV RKFPV 49x-*M   | WKV FSFDV 49x-*M   | WKV FKFDV 49x-*M   |
| RSCV WSCV 49x-*M  | RSCV RKCV 49x-*M  | RSCV WKCV 49x-*M   | RSCV RSFPV 49x-*M   | RSCV RKFPV 49x-*M  | RSCV FSFDV 49x-*M  | RSCV FKFDV 49x-*M  |
| WSCV WSCV 49x-*M  | WSCV RKCV 49x-*M  | WSCV WKCV 49x-*M   | WSCV RSFPV 49x-*M   | WSCV RKFPV 49x-*M  | WSCV FSFDV 49x-*M  | WSCV FKFDV 49x-*M  |
|   | RKCV RKCV 49x-*M  | RKCV WKCV 49x-*M   | RKCV RSFPV 49x-*M   | RKCV RKFPV 49x-*M  | RKCV FSFDV 49x-*M  | RKCV FKFDV 49x-*M  |
|   |   | WKCV WKCV 49x-*M   | WKCV RSFPV 49x-*M   | WKCV RKFPV 49x-*M  | WKCV FSFDV 49x-*M  |  |

We reserve the right to make technical alterations without prior notice.

FOUNDATION™ fieldbus

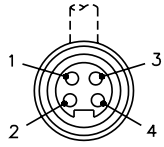
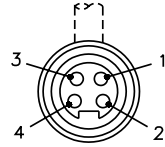
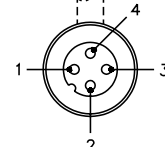
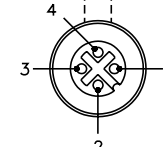
| Minifast  |   | Pinouts  | Eurofast  |   |
|---|---|--|---|---|
| Male  | Female  |  | Male  | Female  |
|  |  | 1. Blue (- Voltage)<br>2. Brown (+ Voltage)<br>3. Bare (Shield Drain Wire)<br>4. Green/Yellow (Ground) |  |  |

# FOUNDATION™ fieldbus Physical Media Connectivity

## Cordset and Receptacle Connector Dimensions

### Specifications

|                         |                                       |                             |                                      |
|-------------------------|---------------------------------------|-----------------------------|--------------------------------------|
| <b>Overmold:</b>        | TPU                                   | <b>Protection:</b>          | NEMA 1, 3, 4, 6P and IEC IP 68       |
| <b>Coupling Nut:</b>    | Nickel Plated CuZn or Stainless Steel | <b>Rated Voltage:</b>       | 300 V                                |
| <b>Contact Carrier:</b> | TPU                                   | <b>Rated Current:</b>       | 9 A                                  |
| <b>Contacts:</b>        | Gold Plated CuZn                      | <b>Ambient Temperature:</b> | -40 °C to +105 °C (-40 °F to +221°F) |

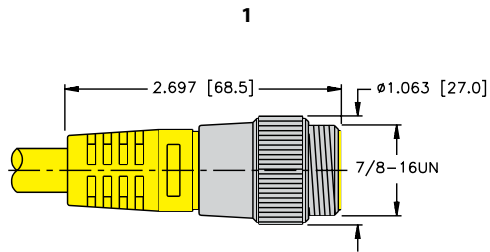

RSV ..

Page N8

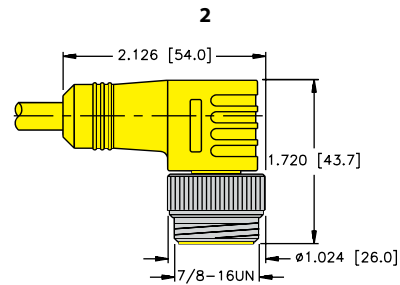

WSV ..

Page N8

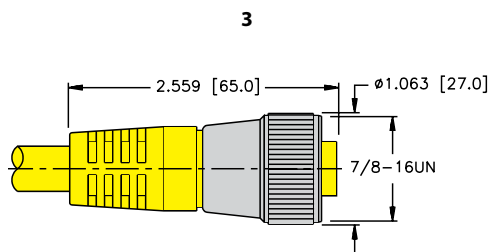

RKV ..

Page N8

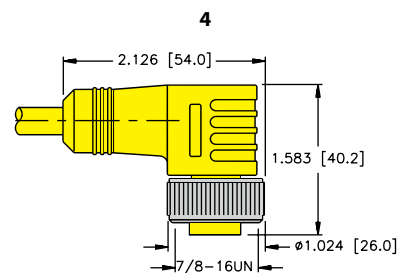

WKV ..

Page N8

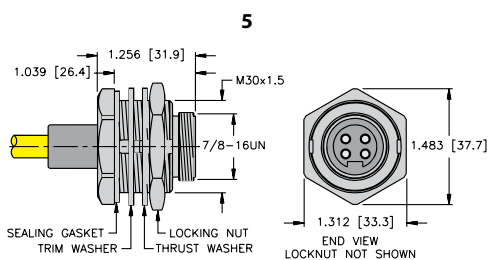

RSFPV ..

Page N9

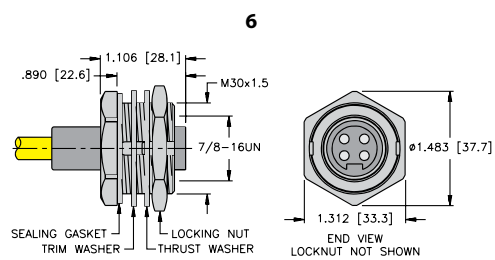

RKFPV ..

Page N9

We reserve the right to make technical alterations without prior notice.



Cordset and Receptacle Connector Dimensions

Specifications

|                         |                                       |                             |                                      |
|-------------------------|---------------------------------------|-----------------------------|--------------------------------------|
| <b>Overmold:</b>        | TPU                                   | <b>Protection:</b>          | NEMA 1, 3, 4, 6P and IEC IP 68       |
| <b>Coupling Nut:</b>    | Nickel Plated CuZn or Stainless Steel | <b>Rated Voltage:</b>       | 250 V                                |
| <b>Contact Carrier:</b> | TPU or POM (Nylon)                    | <b>Rated Current:</b>       | 4 A                                  |
| <b>Contacts:</b>        | Gold Plated CuZn                      | <b>Ambient Temperature:</b> | -40 °C to +105 °C (-40 °F to +221°F) |

We reserve the right to make technical alterations without prior notice.

7

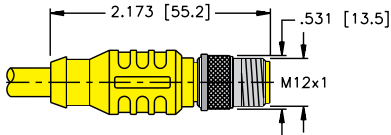

RSCV ..

Page N8

8

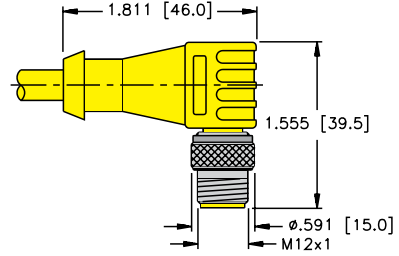

WSCV ..

Page N8

9

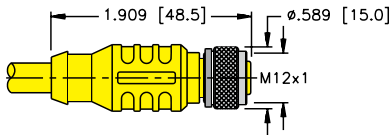

RKCV ..

Page N8

10

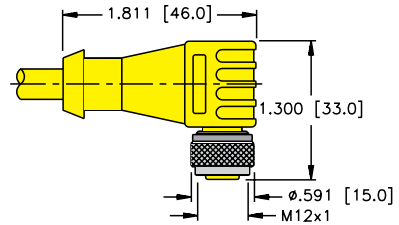

WKCV ..

Page N8

11

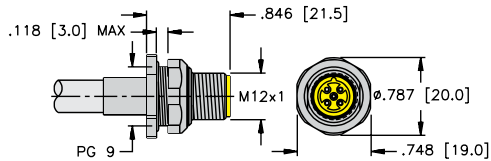

FSFDV ..

Page N9

12

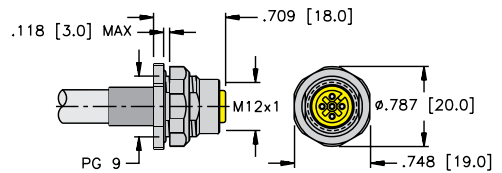

FKFDV ..

Page N9

FOUNDATION™ fieldbus

# FOUNDATION™ fieldbus Physical Media Connectivity

## Eurofast® Heavy Duty Cordsets

- Heavy Duty Coupling Nut completely supports the Molded Plug Body
- Provides superior strength



| Housing Style                             | Female Part Number | Female Part Number | Features   | Pinout                                  |
|---|--------------------|--------------------|--|---|
| <p><b>RKGV..</b></p> <p><b>RSGV..</b></p> | <b>RKGV-49x-*M</b> | <b>RSGV-49x-*M</b> | TPU Nickel plated CuZn or stainless steel, 250 V, 4 A, -40 °C to +105 °C, heavy coupling nut completely supports the molded plug body to provide superior strength | <p><b>Female</b></p> <p><b>Male</b></p> |

\* Indicates length in meters.

x Indicates cable type.

For nickel plated brass coupling nut change: RSGV ... to RSG ... or RKGV ... to RKG ...

We reserve the right to make technical alterations without prior notice.

## Terminating Resistors

- Terminating Resistors stabilize and minimize Reflections on the Bus Line
- A Terminating Resistor is required at the beginning and end of the Main Bus Line



| Housing Style | Part Number       | Features   | Pinout             |
|---------------|-------------------|--|--------------------|
|               | <b>RSV 49-TR</b>  | Nickel plated brass or stainless steel, 250 V, 4 A, -40 °C to +75 °C, male Minifast® connector | <p><b>Male</b></p> |
|               | <b>RSEV 49-TR</b> | Nickel plated brass or stainless steel, 250 V, 4 A, -40 °C to +75 °C, male Eurofast connector  | <p><b>Male</b></p> |

## Tees

- Creates a Drop or Branch from the Main Bus Line
- Minifast® Connectors on Bus Line
- Minifast or Eurofast® Connectors on Dropline



| Housing Style | Part Number           | Features  | Wiring Diagrams |
|---------------|-----------------------|---|-----------------|
|               | <b>RSV-2RKV 49</b>    | TPU, 250 V, 4 A, -40 °C to +75 °C, data, ground, shield stainless steel coupling nuts |                 |
|               | <b>RSV FKV RKV 49</b> | TPU, 250 V, 4 A, -40 °C to +75 °C, data, ground, shield stainless steel coupling nuts |                 |
|               | <b>RSCV 2RKCV 49</b>  | TPU, 250 V, 4 A, -40 °C to +75 °C, stainless steel coupling nuts                      |                 |
|               | <b>RSCV WKCV 49</b>   | TPU, 250 V, 4 A, -40 °C to +75 °C, stainless steel coupling nuts                      |                 |
|               | <b>RSCV RKCVCV 49</b> | TPU, 250 V, 4 A, -40 °C to +75 °C, stainless steel coupling nuts                      |                 |

We reserve the right to make technical alterations without prior notice.

FOUNDATION™ fieldbus

### Pinouts

| Minifast |        | Eurofast |        |
|----------|--------|----------|--------|
| Male     | Female | Male     | Female |
|          |        |          |        |

# FOUNDATION™ fieldbus Physical Media Connectivity

## Gender Changers and Elbow Connectors

- Allows quick and easy changes from Male to Female Minifast® Connectors



| Housing Style | Part Number       | Specs                                 | Application   | Wiring Diagrams |
|---------------|-------------------|---------------------------------------|---|-----------------|
|               | <b>RSV RSV 49</b> |                                       | Male Minifast Gender Changer<br>• Changes female cordset to male receptacle   |                 |
|               | <b>RKV RKV 49</b> | TPU<br>250 V, 4 A<br>-40 °C to +75 °C | Female Minifast Gender Changer<br>• Changes female cordset to male receptacle |                 |
|               | <b>WSV RKV 49</b> |                                       | Minifast Elbow<br>• Right angle male to female connector                      |                 |

We reserve the right to make technical alterations without prior notice.

### Pinouts

| Minifast |        |
|----------|--------|
| Male     | Female |
|          |        |

Surge Suppressor

- Protects Data Communication Lines (V+ and V-)
- Absorbs the front end of the Transient, responding in less than a Nanosecond
- Diverts the Surge Energy to Ground



| Housing       | Part Number   | Features   | Application                      | Pinout                                    |
|---------------|---------------|--|----------------------------------|---|
| See Drawing 1 | RSV RKV 49 SS | <p><b>Electrical</b></p> <p>Contact Carrier Material ..... Thermoplastic Polyurethane</p> <p>Mold Material/Color ..... Thermoplastic Polyurethane/Yellow</p> <p>Contact Material/Plating ..... Gold-Plated Brass</p> <p>Coupling Nut Material ..... Stainless Steel</p> <p>Max. Operating Voltage ..... 36 VDC</p> <p>Max. Operating Current ..... 600 mA</p> <p>Max. Clamping Voltage ..... 58 V</p> <p>Surge Current (8/20µs ≤5 shots) ..... 20kA</p> <p>Temperature Rating ..... -40 °C to +85 °C</p> <p>Protection Class (VDE 0110 b) ..... Meets NEMA 1,3,4,6,13</p> <p>Insulation Resistance ..... ≥40 MΩ</p> <p>Capacitance Between V+, V- at 24 V ... 0.4nF</p> <p><b>Mechanical</b></p> <ul style="list-style-type: none"> <li>• Ground Stud: 10-32 stainless steel</li> <li>• Operating temperature: -40 °C to +85 °C</li> </ul> | Male and Female Minifast®, 4-pin | <p><b>Female</b></p> <p><b>Female</b></p> |

We reserve the right to make technical alterations without prior notice.

FOUNDATION™ fieldbus

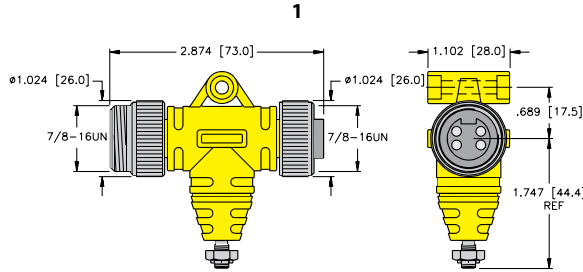

# FOUNDATION™ fieldbus Physical Media Connectivity

## Feed Through Connectors

- Receptacles provide transition from Male to Female Connectors
- Available for Bulkhead and Feed Through applications



| Housing Style | Part Number            | Features  | Pinout                                  |
|---------------|------------------------|---|---|
|               | <b>RSFV RKFV 49/22</b> | Stainless steel, 300 V, 9 A, -40 °C to +75 °C, straight male/female feed-through, for use with Minifast® cordsets | <p><b>Female</b></p> <p><b>Male</b></p> |
|               | <b>FKV FSV 49/M12</b>  | Stainless steel, 250 V, 4 A, -40 °C to +75 °C, straight male/female connector, for use with Eurofast® cordsets    | <p><b>Female</b></p> <p><b>Male</b></p> |

We reserve the right to make technical alterations without prior notice.

Standard housing material is nickel plated brass. "RSF RKF .."; "RSFV RKFV .." indicates stainless steel housing.

### Panel Cutout RSFV RKFV 48/22

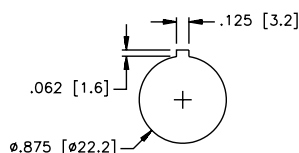

### Panel Cutout WFS

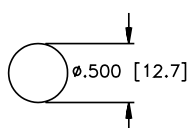

(7/8-16 UN) Minifast® Receptacles

- Provides quick connection to Field Devices
- available for 1/2-14 NPT, 1/2-14 NPSM, 3/4-14 NPT and M20 Threads



We reserve the right to make technical alterations without prior notice.

| Housing Style              | Female Part Number      | Male Part Number        | Features   | Pinout               |
|----------------------------|-------------------------|-------------------------|--|----------------------|
| <p><b>RKFV../14.5</b></p>  | <b>RKFV 49-*M/14.5</b>  | <b>RSFV 49-*M/14.5</b>  | Nickel plated CuZn or stainless steel, 300 V, 9 A, -40 °C to +105 °C, 1/2-14 NPT full length threads | <p><b>Female</b></p> |
| <p><b>RSFV../14.5</b></p>  |                         |                         |  |                      |
| <p><b>RKFV../14.75</b></p> | <b>RKFV 49-*M/14.75</b> | <b>RSFV 49-*M/14.75</b> | Nickel plated CuZn or stainless steel, 300 V, 9 A, -40 °C to +105 °C, 3/4-14 NPT full length threads | <p><b>Female</b></p> |
| <p><b>RSFV../14.75</b></p> |                         |                         |  |                      |
| <p><b>RKFV..*M20</b></p>   | <b>RKFV 49-*M/M20</b>   | <b>RSFV 49-*M/M20</b>   | Nickel plated CuZn or stainless steel, 300 V, 9 A, -40 °C to +105 °C, M20x1.5 threads                | <p><b>Male</b></p>   |
| <p><b>RSFV..*M20</b></p>   |                         |                         |  |                      |

Standard cable length is 0.5 meters. Consult factory for other lengths.  
 Standard housing material is nickel plated brass housing. "RKF .."; "RKFV .." indicates 316 stainless steel.  
 For locknuts to be included, add "W/LN" to the end of the part number.

# FOUNDATION™ fieldbus Physical Media Connectivity

## (7/8-16 UN) Minifast® Receptacles

- Provides quick connection to Field Devices
- Available for 1/2-14 NPT, 1/2-14 NPSM, 3/4-14 NPT and M20 Threads



| Housing Style          | Female Part Number | Male Part Number  | Features  | Pinout               |
|------------------------|--------------------|-------------------|---|----------------------|
| <p><b>RKFV..*M</b></p> | <b>RKFV 49-*M</b>  | <b>RSFV 49-*M</b> | Nickel plated CuZn or stainless steel, 300 V, 9 A, -40 °C to +105 °C, 1/2-14 NPSM threads | <p><b>Female</b></p> |
| <p><b>RSFV..*M</b></p> |                    |                   |   | <p><b>Male</b></p>   |

Standard cable length is 0.5 meters. Consult factory for other lengths.  
 Standard housing material is nickel plated brass housing. "RKF .."; "RKFV .." indicates 316 stainless steel.  
 For locknuts to be included, add "W/LN" to the end of the part number.

We reserve the right to make technical alterations without prior notice.

**Male End View**

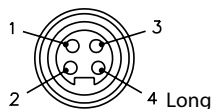

- 1 = BU (-voltage)
- 2 = BN (+ voltage)
- 3 = N/C
- 4 = GN/YE (ground)

**49 Series**

**Male End View**

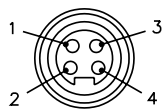

- 1 = BU
- 2 = BN
- 3 = N/C
- 4 = N/C

**49T Series**

**Male End View**

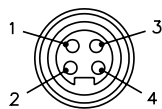

- 1 = BU (-voltage)
- 2 = BN (+ voltage)
- 3 = GY
- 4 = N/C

**49D Series**

**Male End View**

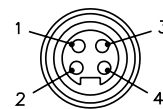

- 1 = BU (-voltage)
- 2 = BN (+ voltage)
- 3 = GY
- 4 = GN/YE (ground)

**49E Series**



(M12x1) Eurofast® Female Receptacles

- Mounted for quick connection to Enclosures
- Available for 1/2-14 NPT, 1/2-14 NPSM, 3/4-14 NPT and M20 Threads



We reserve the right to make technical alterations without prior notice.

| Housing Style             | Female Part Number     | Male Part Number       | Features   | Pinout               |
|---------------------------|------------------------|------------------------|--|----------------------|
| <p><b>FKV../14.5</b></p>  | <b>FKV 49-*M/14.5</b>  | <b>FSV 49-*M/14.5</b>  | Nickel plated CuZn or stainless steel, 250 V, 4 A, -40 °C to +105 °C, 1/2-14 NPT full length threads | <p><b>Female</b></p> |
| <p><b>FSV../14.5</b></p>  |                        |                        |  |                      |
| <p><b>FKV../14.75</b></p> | <b>FKV 49-*M/14.75</b> | <b>FSV 49-*M/14.75</b> | Nickel plated CuZn or stainless steel, 250 V, 4 A, -40 °C to +105 °C, 3/4-14 NPT full length threads | <p><b>Male</b></p>   |
| <p><b>FSV../14.75</b></p> |                        |                        |  |                      |
| <p><b>FKV../M20</b></p>   | <b>FKV 49-*M/M20</b>   | <b>FSV 49-*M/M20</b>   | Nickel plated CuZn or stainless steel, 250 V, 4 A, -40 °C to +105 °C, M20x1.5 Threads                | <p><b>Male</b></p>   |
| <p><b>FKV../M20</b></p>   |                        |                        |  |                      |

Standard cable length is 0.5 meters. Consult factory for other lengths.  
 Standard housing material is stainless steel. "RKF .."; "RKFV .." indicates 316 nickel plated brass housing.

FOUNDATION™ fieldbus

# FOUNDATION™ fieldbus Physical Media Connectivity

## (M12x1) Eurofast® Female Receptacles

- Mounted for quick connection to Enclosures
- Available for 1/2-14 NPT, 1/2-14 NPSM, 3/4-14 NPT and M20 Threads



| Housing Style         | Female Part Number | Male Part Number | Features  | Pinout               |
|-----------------------|--------------------|------------------|---|----------------------|
| <p><b>FKV..*M</b></p> | <b>FKV 49-*M</b>   | <b>FSV 49-*M</b> | Nickel plated CuZn or stainless steel, 250 V, 4 A, -40 °C to +105 °C, 1/2-14 NPSM threads | <p><b>Female</b></p> |
| <p><b>FSV..*M</b></p> |                    |                  |   | <p><b>Male</b></p>   |

Standard cable length is 0.5 meters. Consult factory for other lengths.  
 Receptacles require a 13/16" (21.0 mm) clearance hole for panel mounting.  
 Standard housing material is stainless steel. "RKF .."; "RKFV .." indicates 316 nickel plated brass housing.

We reserve the right to make technical alterations without prior notice.

**Male End View**

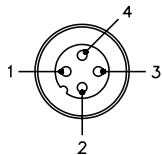

- 1 = BU (-voltage)
- 2 = BN (+ voltage)
- 3 = N/C
- 4 = GN/YE (ground)

**49 Series**

**Male End View**

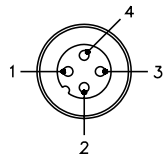

- 1 = BU (-voltage)
- 2 = BN (+ voltage)
- 3 = N/C
- 4 = N/C

**49T Series**

**Male End View**

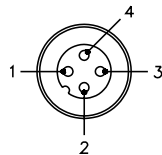

- 1 = BU (-voltage)
- 2 = BN (+ voltage)
- 3 = GY
- 4 = N/C

**49D Series**

**Male End View**

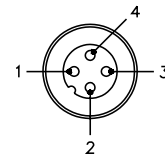

- 1 = BU (-voltage)
- 2 = BN (+ voltage)
- 3 = GY
- 4 = GN/YE (ground)

**49E Series**

Minifast® Field Wireable Connectors with Labels

- Allows for quick connection when Pre-Molded Cables are not available
- Available for Male and Female Connectors
- Color Coded Wire Connection for FOUNDATION fieldbus



| Housing Style | Female Part Number      | Male Part Number        | Features  | Pinout               |
|---------------|-------------------------|-------------------------|---|----------------------|
|               | <b>BKV 4140-0/11/FF</b> | <b>BSV 4140-0/11/FF</b> | Glass filled nylon, stainless steel coupling nut, PG 9 cable gland, accepts 8-10 mm cable diameter, screw terminals, 90 °C, 300 V, 9 A, mates with standard, 4-pin cordsets and receptacles   | <p><b>Female</b></p> |
|               | <b>BKV 4140-0/16/FF</b> | <b>BSV 4140-0/16/FF</b> | Glass filled nylon, stainless steel coupling nut, PG 16 cable gland, accepts 12-14 mm cable diameter, screw terminals, 90 °C, 600 V, 9 A, mates with standard, 4-pin cordsets and receptacles | <p><b>Male</b></p>   |

We reserve the right to make technical alterations without prior notice.

FOUNDATION™ fieldbus

Gender Changer

- Allows Quick and Easy Changes from Male to Female and Minifast to Eurofast® Connectors



| Housing Style | Part Number          | Features   | Wiring Diagrams |
|---------------|----------------------|--|-----------------|
|               | <b>RSM 49-FK 4.4</b> | Nickel plated CuZn or stainless steel, 250 V, 4 A, -40 °C to +75 °C, female Eurofast, male Minifast, 4-pin |                 |

Pinouts

| Minifast           | Eurofast             |
|--------------------|----------------------|
| <p><b>Male</b></p> | <p><b>Female</b></p> |

# FOUNDATION™ fieldbus Physical Media Connectivity

## FOUNDATION fieldbus, Conduit Adapters

- Converts Standard Conduits to Quick Disconnect
- Fiberglass Reinforced Nylon Housings
- Nickel Plated Brass Connectors available
- 3/4" Form 8 or Mark 9
- 1" Form 7 available upon request
- Gasket and Mounting Screws provided
- IP67



| Housing Style | 1 Port Part Number | 2 Port Part Number | Specifications   | Pinout            |
|---------------|--------------------|--------------------|--|-------------------|
|               | BCA-49-E123        | BCA-49-E223        | 3/4" Form 8 or Mark 9, M12 x 1 stainless steel connectors                              | <b>Female</b><br> |
|               | BCA-49-M123        | BCA-49-M223        | 3/4" Form 8 or Mark 9, 7/8"-16 UN stainless steel connectors                           | <b>Female</b><br> |
|               | BCA-49SC-M123      | BCA-49SC-M223      | Short circuit protection, 3/4" Form 8 or Mark 9, 7/8"-16 UN stainless steel connectors |                   |

## FOUNDATION™ fieldbus, Conduit Adapters

- Attaches to Standard Single Gang Electrical Box
- Stainless Steel with Stainless Steel Connectors
- Gasket and Mounting Screws Provided
- IP67



| Housing Style | Part Number | Specifications                                   | Pinout            |
|---------------|-------------|--|-------------------|
|               | BPA-49-M113 | 7/8"-16 UN, -40 °C to +75 °C (-40 °F to +167 °F) | <b>Female</b><br> |

We reserve the right to make technical alterations without prior notice.

|                          |            |
|--------------------------|------------|
| <b>PROFIBUS-DP Cable</b> | <b>P3</b>  |
| <b>Part Number Key</b>   | <b>P4</b>  |
| <b>Cordsets</b>          | <b>P6</b>  |
| <b>Receptacles</b>       | <b>P13</b> |
| <b>Field Wireables</b>   | <b>P17</b> |

**Features**

- Cables that meet the requirements of EN 50170 for communication up to 12 MBAUD
- PLTC rated cable (CSA FT4)
- Oil RES II and sunlight resistant
- M12 reverse keyed connectors
- Up to 4 Amp and 250 Volt rated
- IP67/IP69K rated



## PROFIBUS-DP System Description

PROFIBUS-DP is an industrial network protocol that connects field I/O devices in order to eliminate hard wiring. The network connection increases device-level diagnostic capabilities, while also providing high-speed communication between devices.

PROFIBUS-DP is based on the RS-485 serial data transfer standard. In most cases, the termination and physical media rules for PROFIBUS-DP are the same as those required for RS-485 communication. A PROFIBUS-DP network supports up to 126 nodes and virtually an unlimited amount of I/O. The bus uses a trunkline/dropline topology. Power and communication are provided via separate cables, allowing easy segmentation of the power structure to avoid overloading.

PROFIBUS-DP is capable of running at data rates as high as 12 Mbaud. When used at high data rates, the cable drop length from the trunk to a node is severely limited. For example, when used at 12 Mbaud, nodes must be directly connected to the trunk, with no drop length allowed.

## Typical System Configuration

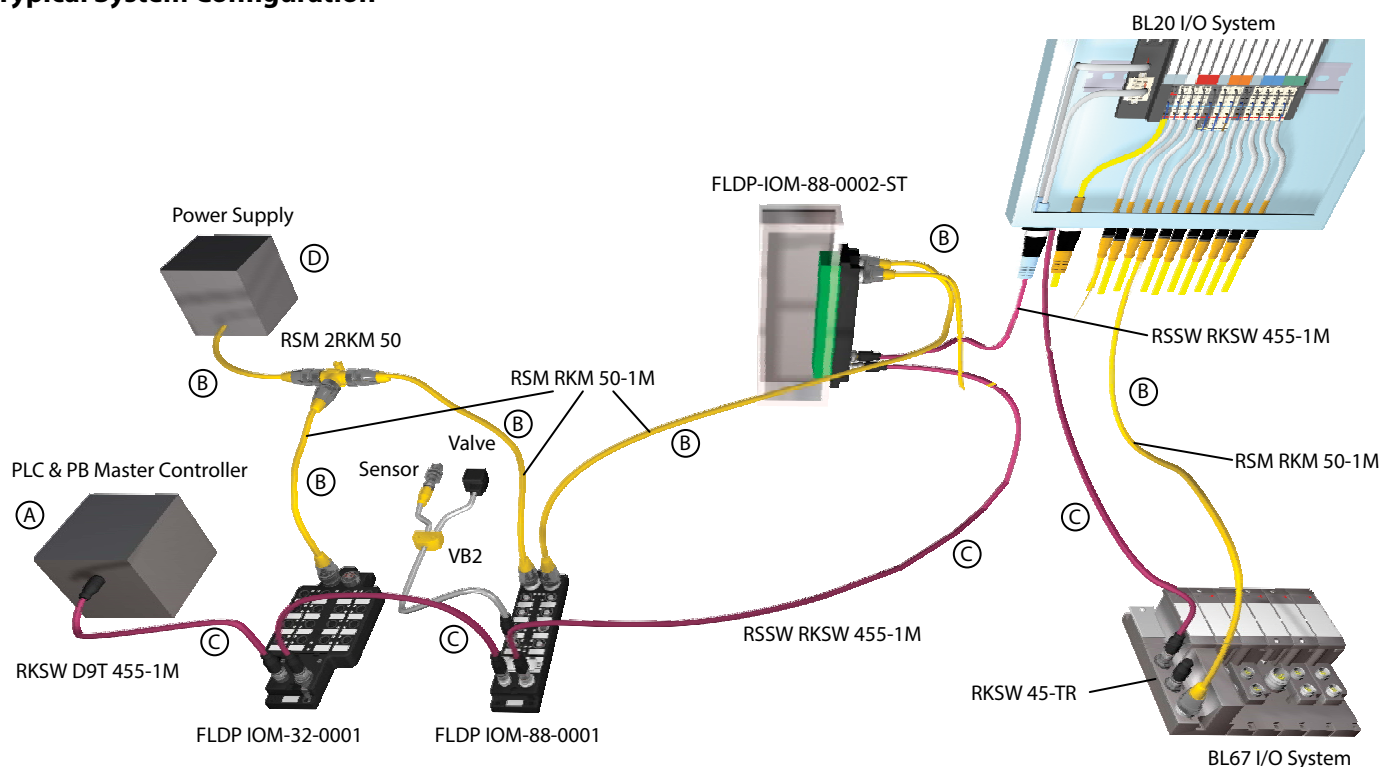

## Basic Parts List

A typical PROFIBUS-DP system consists of the following parts:

- A - Master
- B - Power cable
- C - Communication cable
- D - Power supply

PROFIBUS-DP stations require a network master (also called a scanner) to interface the stations to the host controller. Turck PROFIBUS-DP stations are designed to be fully compatible with PROFIBUS-DP equipment from other manufacturers.

**Cordsets**

Turck offers a complete line of molded PROFIBUS-DP cordsets to facilitate network installation, resulting in a faster start-up and fewer wiring errors. The bus and drop cables are specially designed foil-shielded, high-flex cables with very low inductance and capacitance to minimize propagation delay time. PROFIBUS-DP cables consist of a shielded and twisted data pair with a bare drain wire.

In most cases, connections of the bus cable to the stations are made using 5-pin reverse-key Eurofast® (M12) connectors. A variety of stations are also available that support D9 type connections. Power for most stations is provided through one or two 5-pin Minifast® (7/8-16 UN) connectors.

Turck cordsets for the PROFIBUS-DP system are available in standard lengths. Please contact your local sales representative to order custom lengths.

**Communication Rate/Cycle Time**

PROFIBUS-DP specifications define multiple transmission speeds ranging from 9.6 Kbaud to 12 Mbaud. All nodes on a network must communicate at the same rate.

The complete cycle time of a PROFIBUS-DP system is affected by several factors:

- Number of nodes being scanned
- Amount of data produced and consumed by the nodes
- Network communication rate
- Cycle time of the control program

All of these factors must be considered when calculating the cycle time of a particular network.

**Maximum Ratings**

The PROFIBUS-DP bus uses a trunkline/dropline topology. The trunk is the main communication cable and requires the appropriate RS-485 termination at both ends of the trunk. Terminating resistors are available as plug-in Eurofast modules or can be built into the D9 connectors. The length of the trunk depends on the communication rate. Drops or branches off the trunk are allowed, but are greatly limited as the communication rate increases. The table shows the maximum ratings for a trunk at different communication rates.

| Communication Rate | Max. Segment Length |
|--------------------|---------------------|
| 9.6 kbps           | 1200 m              |
| 19.2 kbps          | 1200 m              |
| 93.75 kbps         | 1200 m              |
| 187.5 kbps         | 1000 m              |
| 500 kbps           | 400 m               |
| 1.5 Mbps           | 200 m               |
| 12 Mbps            | 100 m               |

# PROFIBUS® –DP Physical Media Connectivity

## Eurofast® Cordset Part Number Key

Part Number Keys are to assist in IDENTIFICATION ONLY. Consult factory for catalog items not identified.

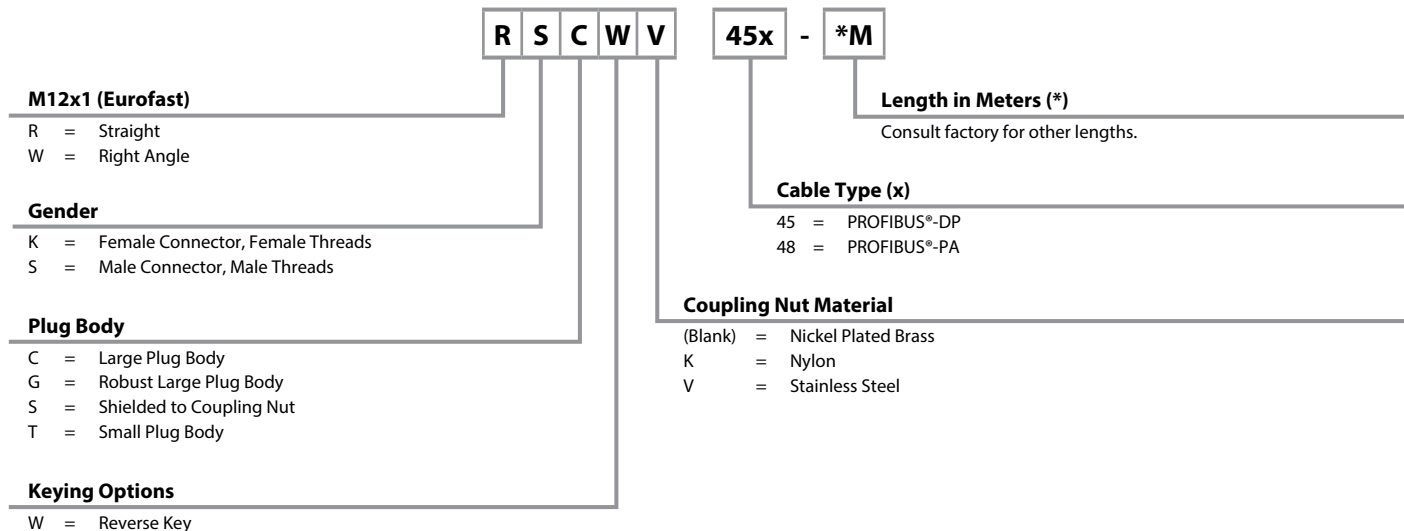

## Eurofast Receptacle Part Number Key

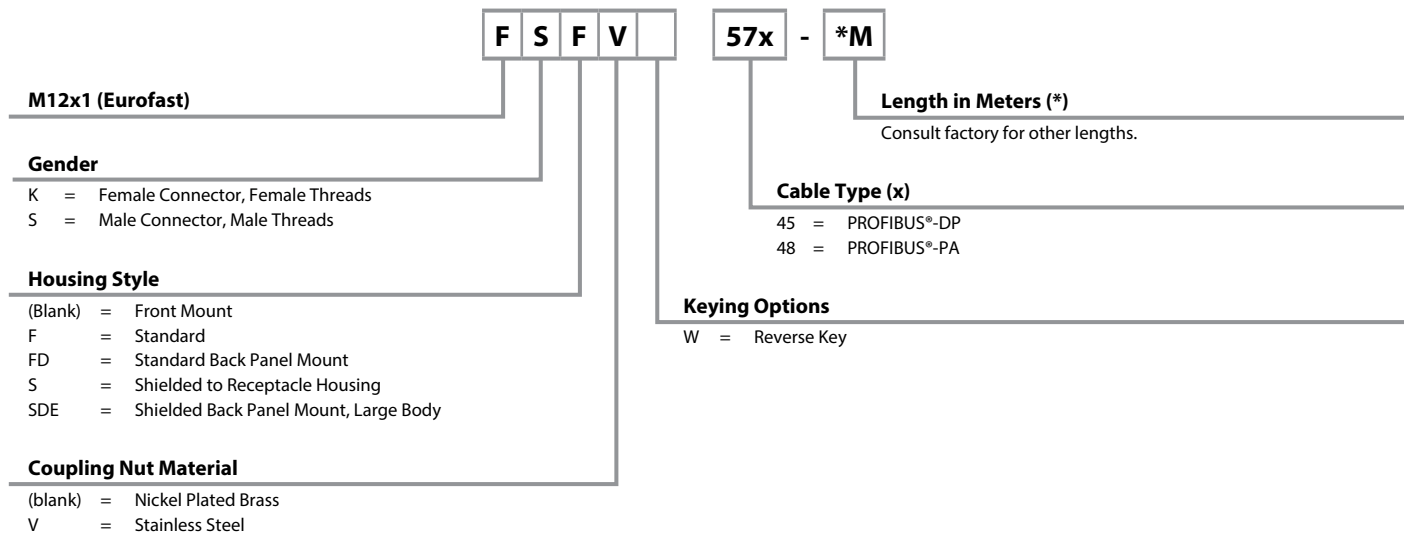



PROFIBUS-DP, Cable Specifications

- Cable that meets the requirements of EN50170-2-2:1996 for communications up to 12 Mbaud

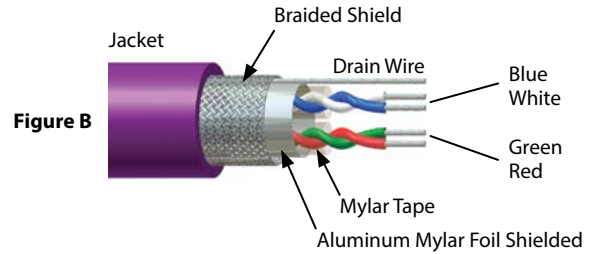
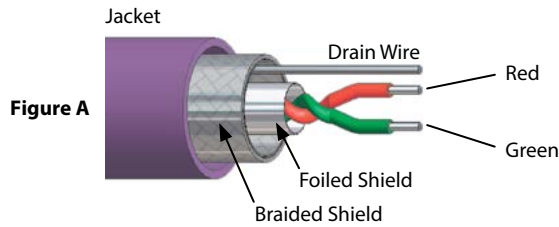

|                      |             |             |             |             |            |            |            |
|----------------------|-------------|-------------|-------------|-------------|------------|------------|------------|
| Baud Rate (k baud)   | 9.6         | 19.2        | 93.75       | 187.5       | 500        | 1500       | 1200       |
| Maximum Trunk Length | 1200 meters | 1200 meters | 1200 meters | 1000 meters | 400 meters | 200 meters | 100 meters |

| Type                          | Approvals  | Data Pair                  |   | 2nd Data Pair     |   | Outer Jacket<br>Material Color<br>Nominal O.D.   | Shields<br>Type<br>Drain Wire | Bulk Cable<br>Part Number /<br>Weight/300 M |
|-------------------------------|--|----------------------------|---|-------------------|---|--|-------------------------------|---|
|                               |  | AWG<br>Color Code          | Characteristic<br>Impedance @<br>1 MHz/Insulation | AWG<br>Color Code | Characteristic<br>Impedance @<br>1 MHz/Insulation |  |                               |   |
| <b>455</b><br>80 °C<br>300 V  | UL PLTC-ER DB<br>CSA CMX-OUTDOOR-CMG<br>AWM I/II A/B, FT 4 | 2X22 AWG<br>RD/GN          | 150 Ohms<br>HDPE                                  | None              | n/a   | PVC, VIOLET,<br>8.5 mm (.335 in)                 | Foil/braid,<br>22 AWG         | RB50672-*M,<br>63 lbs.                      |
| <b>456</b><br>80 °C<br>300 V  | UL recognized AWM<br>CSA AWM I/II A/B, FT 1                | 2X22 AWG<br>RD/GN          | 150 Ohms<br>HDPE                                  | None              | n/a   | TPU, VIOLET,<br>7.9 mm (.310 in)                 | Foil/braid,<br>22 AWG         | RB50683-*M,<br>45 lbs.                      |
| <b>457</b><br>80 °C<br>600 V  | UL recognized AWM<br>VW-1                                  | 2X22 AWG<br>RD/GN<br>Solid | 150 Ohms<br>HDPE                                  | None              | n/a   | TPU, VIOLET,<br>7.8 mm (.305 in)                 | Foil/braid                    | RB50708-*M,<br>39 lbs.                      |
| <b>458</b><br>80 °C<br>300 V  | UL recognized AWM<br>CSA AWM I/II A/B, FT 1                | 2X22 AWG<br>RD/GN          | 150 Ohms<br>HDPE                                  | None              | n/a   | TPU, PLUM,<br>8.5 mm (.335 in)                   | Foil/braid,<br>22 AWG         | RB50692-*M,<br>52 lbs.<br>Flexlife®         |
| <b>4511</b><br>80 °C<br>300 V | UL PLTC<br>CSA CMX-OUTDOOR-CMG<br>AWM I/II A/B, FT 4       | 2X22 AWG<br>RD/GN          | 150 Ohms<br>HDPE                                  | None              | n/a   | PVC, VIOLET,<br>8.5 mm (.335 in)                 | Foil/braid,<br>22 AWG         | RB50881-*M,<br>58 lbs.<br>Flexlife          |
| <b>4515</b><br>80 °C<br>600 V | IEC-60332-3<br>IEC-60754-1<br>EN 50267-2-2                 | 2X22 AWG<br>RD/GN          | 150 Ohms<br>HDPE                                  | None              | n/a   | TPU, VIOLET,<br>7.9 mm (.310 in)<br>Halogen-free | Foil/braid,<br>22 AWG         | RB51225-*M,<br>41 lbs.                      |
| <b>590</b><br>80 °C<br>300 V  | UL recognized AWM<br>CSA AWM I/II A/B, FT 1                | 2X22 AWG<br>RD/GN          | 150 Ohms<br>HDPE                                  | 2X22 AWG<br>BU/WT | 150 Ohms<br>HDPE                                  | PVC, VIOLET,<br>8.4 mm (.330 in)                 | Foil/braid,<br>22 AWG         | RB51057-*M,<br>52 lbs.                      |





\* Indicates length in meters.  
Standard spool lengths are 30, 75, 100, 150, 200, 225, 300 meters. Consult factory for other lengths.

We reserve the right to make technical alterations without prior notice.

PROFIBUS®-DP Connectivity

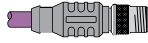
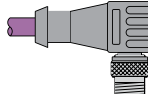
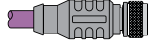
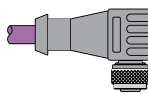
# PROFIBUS® –DP Physical Media Connectivity

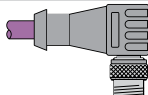
## PROFIBUS-DP, (M12x1) Eurofast® Cable and Cordset Selection Matrix

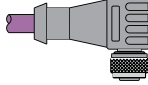
|   |  | Eurofast (Male)   |   | Eurofast (Female)   |  |
|---|--|---|---|---|--|
|   |  | 1 <br>RSSW | 2 <br>WSSW | 3 <br>RKSX | 4 <br>WKSX |
| <br>Bare |  | RSSW 45x-*M   | WSSW 45x-*M   | RKSX 45x-*M   | WKSX 45x-*M  |
| Eurofast (Male)   | 1 <br>RSSW  | RSSW RSSW 45x-*M  | RSSW WSSW 45x-*M  | RSSW RKSX 45x-*M  | RSSW WKSX 45x-*M   |
|   | 2 <br>WSSW  |   | WSSW WSSW 45x-*M  | WSSW RKSX 45x-*M  | WSSW WKSX 45x-*M   |
| Eurofast (Female)   | 3 <br>RKSX  |   |   | RKSX RKSX 45x-*M  | RKSX WKSX 45x-*M   |
|   | 4 <br>WKSX |   |   |   | WKSX WKSX 45x-*M   |

See page P8 for dimensional drawings.

\* Indicates length in meters.

x Indicates cable type.

Standard cable lengths are 1, 2, 4, 6, 8, 10, 15, and in +5 meter increments from there. Consult factory for other lengths.

For stainless steel coupling nuts change part number RSSW...RSSWV.

We reserve the right to make technical alterations without prior notice.

### Pinouts

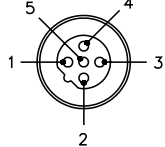
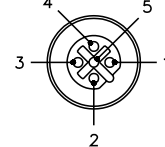
| Eurofast  | 45 series pinout  | 59 series pinout   | Eurofast  |
|---|---|--|---|
| <b>Male</b>   |   |  | <b>Female</b>   |
|  | 1. N/C<br>2. Green (TxD)<br>3. N/C<br>4. Red (RxD)<br>5. Bare (Shield Drain Wire) | 1. Blue (TxD_1)<br>2. Green (TxD)<br>3. White (RxD_1)<br>4. Red (RxD)<br>5. Bare (Shield Drain Wire) |  |

Specifications

|                         |                                       |                             |                                      |
|-------------------------|---------------------------------------|-----------------------------|--------------------------------------|
| <b>Overmold:</b>        | TPU                                   | <b>Protection:</b>          | NEMA 1, 3, 4, 6P and IEC IP 68       |
| <b>Coupling Nut:</b>    | Nickel Plated CuZn or Stainless Steel | <b>Rated Voltage:</b>       | 250 V                                |
| <b>Contact Carrier:</b> | TPU or POM (Nylon)                    | <b>Rated Current:</b>       | 4 A                                  |
| <b>Contacts:</b>        | Gold Plated CuZn                      | <b>Ambient Temperature:</b> | -40 °C to +75 °C (-22 °F to +167 °F) |

We reserve the right to make technical alterations without prior notice.

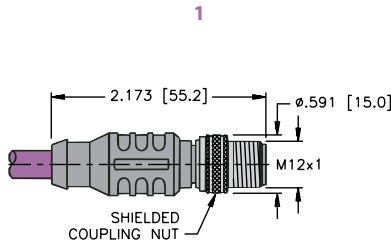

RSSW ..

Page P6

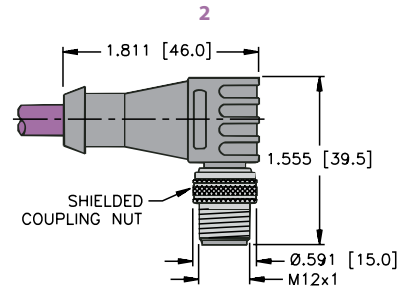

WSSW ..

Page P6

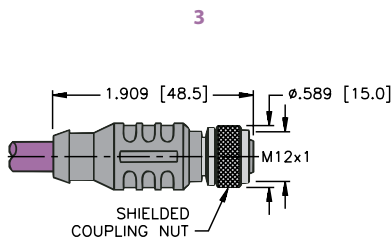

RKSU ..

Page P6

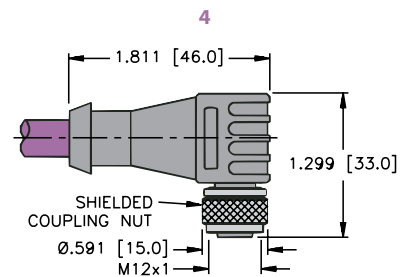

WKSU ..

Page P6

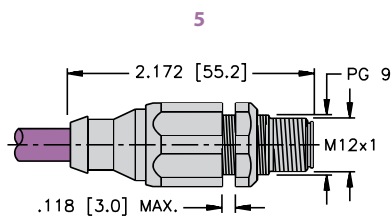

FSSDWE ..

Page P8

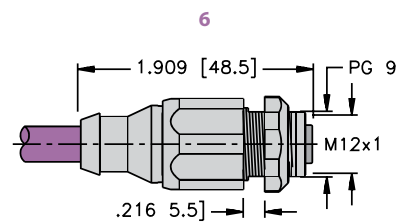





FKSDWE ..

Page P8

PROFIBUS®-DP Connectivity

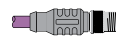
# PROFIBUS® –DP Physical Media Connectivity

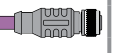
## PROFIBUS-DP, (M12x1) Eurofast® Cable and Cordset Selection Matrix

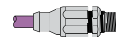
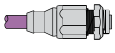
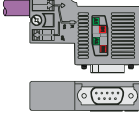
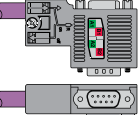
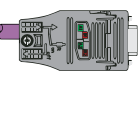
|                       |            | Eurofast  |   |   |  |   |   |   |
|-----------------------|------------|---|---|---|--|---|---|---|
|                       |            | Male  |   |   | Female   |   | Male  | Female  |
|                       |            | 1   | 2   | 3   | 4  | 5   | 6   |   |
|                       |            |            |  |  |  |  |  |  |
|                       |            | Bare  | RSSW  | WSSW  | RKSX   | WKSX  | FSSDWE  | FKSDWE  |
| 9-Pin Sub D Connector | Terminator | <br>D9S/T  | D9S/T 45x-*M<br>RSSW D9S/T 45x-*M   | D9S/T 45x-*M<br>WSSW D9S/T 45x-*M   | D9S/T 45x-*M<br>RKSX D9S/T 45x-*M  | D9S/T 45x-*M<br>WKSX D9S/T 45x-*M   | D9S/T 45x-*M<br>FSSDWE D9S/T 45x-*M   | D9S/T 45x-*M<br>FKSDWE D9S/T 45x-*M   |
|                       | Master     | <br>D9SM/T | D9SM/T 45x-*M<br>RSSW D9SM/T 45x-*M   | D9SM/T 45x-*M<br>WSSW D9SM/T 45x-*M   | D9SM/T 45x-*M<br>RKSX D9SM/T 45x-*M  | D9SM/T 45x-*M<br>WKSX D9SM/T 45x-*M   | D9SM/T 45x-*M<br>FSSDWE D9SM/T 45x-*M   | D9SM/T 45x-*M<br>FKSDWE D9SM/T 45x-*M   |
|                       |            | <br>SD9S/T | SD9S/T 45x-*M<br>RSSW SD9S/T 45x-*M   | SD9S/T 45x-*M<br>WSSW SD9S/T 45x-*M   | SD9S/T 45x-*M<br>RKSX SD9S/T 45x-*M  | SD9S/T 45x-*M<br>WKSX SD9S/T 45x-*M   | SD9S/T 45x-*M<br>FSSDWE SD9S/T 45x-*M   | SD9S/T 45x-*M<br>FKSDWE SD9S/T 45x-*M   |

See page P8 and P11 for dimensional drawings.

\* Indicates length in meters.

x Indicates cable type.

Standard cable lengths are 1, 2, 4, 6, 8, 10, 15, and in +5 meter increments from there. Consult factory for other lengths.

For stainless steel coupling nuts change part number RSSW...RSSWV.

### Extension Example:

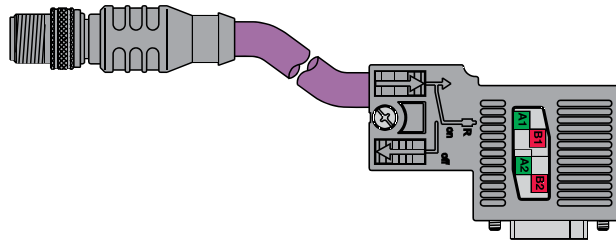



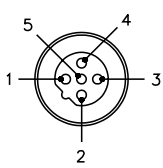
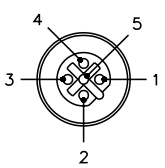
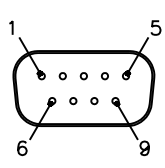

RSSW D9S/T 455-0.3M

### Pinouts



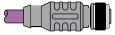

| Eurofast  | 45 series pinout  | Eurofast  | D9   | D9 pinout   |
|---|---|---|--|---|
| Male  | 1. N/C<br>2. Green (TxD)<br>3. N/C<br>4. Red (RxD)<br>5. Bare (Shield Drain Wire) | Female  | Male   | 1 = N/C<br>2 = N/C<br>3 = RD (RXD)<br>4 = N/C<br>5 = N/C<br>6 = N/C<br>7 = N/C<br>8 = GN (TXD)<br>9 = N/C |
|  |   |  |  |   |

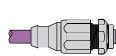
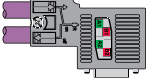
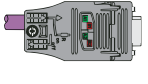
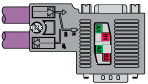
We reserve the right to make technical alterations without prior notice.

PROFIBUS-DP, (M12x1) Eurofast® Cable and Cordset Selection Matrix

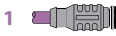
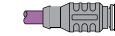
|                 |   | Eurofast  |   |   |   |   |   |   |
|-----------------|---|---|---|---|---|---|---|---|
|                 |   | Male  |   | Female  |   | Male  | Female  |   |
|                 |   |  |  |  |  |  |  |  |
|                 |   | Bare  | RSSW  | WSSW  | RKSW  | WKSW  | FSSDWE  | FKSDWE  |
| <b>Node</b>     |  | D9S 45x-*M  | RSSW D9S RSSW 45x-*M-*M   | WSSW D9S WSSW 45x-*M-*M   | RKSW D9S RKSW 45x-*M-*M   | WKSW D9S WKSW 45x-*M-*M   | FSSDWE D9S FSSDWE 45x-*M-*M   | FKSDWE D9S FKSDWE 45x-*M-*M   |
|                 | D9S   |   |   |   |   |   |   |   |
| <b>Straight</b> |  | SD9S 45x-*M   | RSSW SD9S RSSW 45x-*M-*M  | WSSW SD9S WSSW 45x-*M-*M  | RKSW SD9S RKSW 45x-*M-*M  | WKSW SD9S WKSW 45x-*M-*M  | FSSDWE SD9S FSSDWE 45x-*M-*M  | FKSDWE SD9S FKSDWE 45x-*M-*M  |
|                 | SD9S  |   |   |   |   |   |   |   |
| <b>Node</b>     |  | D9SM 45x-*M   | RSSW D9SM RSSW 45x-*M   | WSSW D9SM WSSW 45x-*M-*M  | RKSW D9SM RKSW 45x-*M-*M  | WKSW D9SM WKSW 45x-*M-*M  | FSSDWE D9SM FSSDWE 45x-*M-*M  | FKSDWE D9S FKSDWE 45x-*M-*M   |
|                 | D9SM  |   |   |   |   |   |   |   |

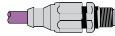
We reserve the right to make technical alterations without prior notice.

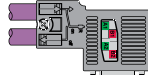
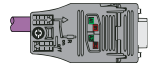
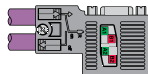
|                 |   | Eurofast  |   |   |   |   |   |   |
|-----------------|---|---|---|---|---|---|---|---|
|                 |   | Male  | Female  | Male  | Female  | Male  | Female  |   |
|                 |   |  |  |  |  |  |  |  |
|                 |   | Bare  | RSSW  | RKSW  | WSSW  | WKSW  | FSSDWE  | FKSDWE  |
| <b>Node</b>     |  | D9S 45x-*M  | RSSW D9S RKSW 45x-*M-*M   |   | WSSW D9S WKSW 45x-*M-*M   |   | FSSDWE D9S FKSDWE 45x-*M-*M   |   |
|                 | D9S   |   |   |   |   |   |   |   |
| <b>Straight</b> |  | SD9S 45x-*M   | RSSW SD9S RKSW 45x-*M-*M  |   | WSSW SD9S WKSW 45x-*M-*M  |   | FSSDWE SD9S FKSDWE 45x-*M-*M  |   |
|                 | SD9S  |   |   |   |   |   |   |   |
| <b>Node</b>     |  | D9SM 45x-*M   | RSSW D9SM RKSW 45x-*M-*M  |   | WSSW D9SM WKSW 45x-*M-*M  |   | FSSDWE D9SM FKSDWE 45x-*M-*M  |   |
|                 | D9SM  |   |   |   |   |   |   |   |

See page P8 and P11-P12 for dimensional drawings.

\* Indicates length in meters.

x Indicates cable type.

Standard cable lengths are 1, 2, 4, 6, 8, 10, 15, and in +5 meter increments from there. Consult factory for other lengths.

For stainless steel coupling nuts change part number RSSW...RSSWV.

PROFIBUS®-DP Connectivity

# PROFIBUS® –DP Physical Media Connectivity

## PROFIBUS-DP, Field Wireable D9 Connectors

- Provides connection to Master or Node in the field
- Maximum Cable O.D. is 8.5 mm

| Housing Style | Part Number               | Features  | Pinout   |
|---------------|---------------------------|---|--|
|               | <b>Connector,PDP,D9S</b>  | -25 °C to +80 °C, right angle, terminating switch         |  |
|               | <b>Connector,PDP,SD9S</b> | -25 °C to +80 °C, straight, terminating switch            | 1. N/C<br>2. N/C<br>3. RED (Bus_B)<br>4. N/C<br>5. N/C<br>6. N/C<br>7. N/C<br>8. Green (Bus_A)<br>9. N/C |
|               | <b>Connector,PDP,D9SM</b> | -25 °C to +80 °C, right angle, master, terminating switch |  |

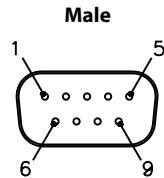

We reserve the right to make technical alterations without prior notice.

Specifications - (D9)

**Terminating Switch:** Yes  
**Protection:** IEC IP 20  
**Rated Voltage:** 4.75-5.25 VDC

**Rated Current:** 5 mA  
**Temperature Rating:** -25 °C to +60 °C  
 \*Max. Cable diameter: 8.5 mm

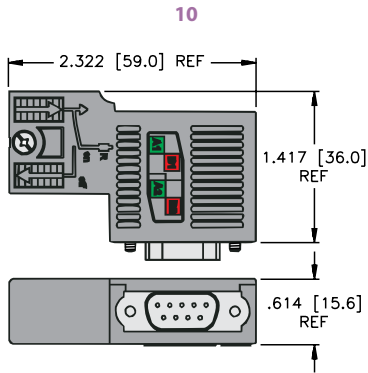

Connector, PDP, D9S

Page P8

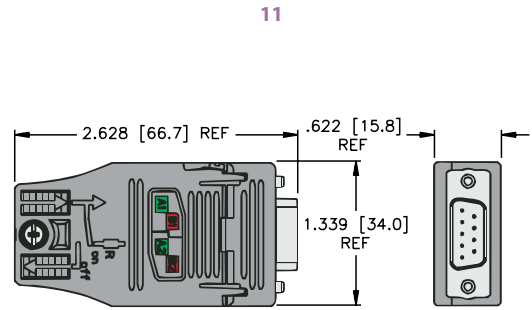

Connector, PDP, SD9S

Page P8

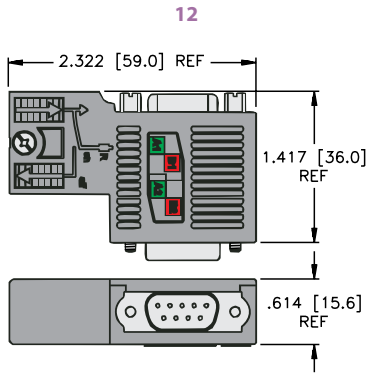

Connector, PDP, D9SM

Page P8

We reserve the right to make technical alterations without prior notice.

PROFIBUS®-DP Connectivity

# PROFIBUS® –DP Physical Media Connectivity

## PROFIBUS-DP, Terminating Resistors

- Terminating Resistors stabilize and minimize reflections on the Bus Line
- A Terminating Resistor is required at the beginning and end of the Main Bus Line



| Housing Style | Part Number       | Features  | Pinout   |                    |
|---------------|-------------------|---|--|--------------------|
|               | <b>RSSW 45-TR</b> | Nickel plated brass, 250 V, 4 A, -40 °C to +75 °C, internal resistor, male Eurofast connector, reverse keyed  | <ol style="list-style-type: none"> <li>1. N/C</li> <li>2. GN</li> <li>3. N/C</li> <li>4. RD</li> <li>5. BARE</li> </ol>        | See Below          |
|               | <b>RKSW 45-TR</b> | Nickel plated brass, 250 V, 4 A, -40 °C to +75 °C, internal resistor, female Eurofast connector, reverse keyed  | <ol style="list-style-type: none"> <li>1. N/C</li> <li>2. GN</li> <li>3. N/C</li> <li>4. RD</li> <li>5. BARE</li> </ol>        | See Below          |
|               | <b>PDP-TRA</b>    | Nickel plated brass, 250 V, 4 A, -40 °C to +75 °C, active terminating resistor, external power supply Minifast® and Eurofast connector, LED signal for power status | <ol style="list-style-type: none"> <li>1. N/C</li> <li>2. BUS_A</li> <li>3. N/C</li> <li>4. BUS_B</li> <li>5. N/C</li> </ol>   | See Below          |
|               |                   |   | <ol style="list-style-type: none"> <li>1. N/C</li> <li>2. GND</li> <li>3. N/C</li> <li>4. UI=24 VDC</li> <li>5. N/C</li> </ol> | <p><b>Male</b></p> |

We reserve the right to make technical alterations without prior notice.

**Pinout Diagram, RSSW 45-TR**

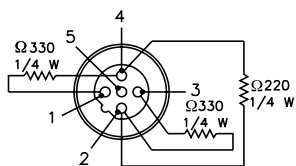

**Eurofast Male Connector**

**Pinout Diagram, RKSW 45-TR**

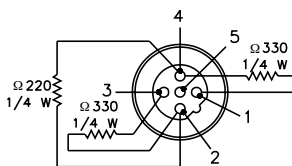

**Eurofast Female Connector**

**Pinout Diagram, PDP-TRA**

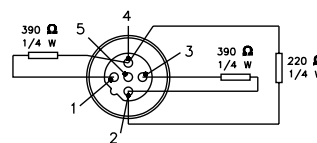

**Eurofast Male Connector**



PROFIBUS-DP, Circuit Board Connectors and OEM Receptacles

- Provides (M12x1) Eurofast® Connection to Field Devices



| Housing Style             | Female Part Number  | Male Part Number    | Features  | Pinout  |
|---------------------------|---------------------|---------------------|---|---|
| <p><b>FKFDW 45..</b></p>  | <b>FKFDW 45-PCB</b> | <b>FSFDW 45-PCB</b> | Nickel plated CuZn or stainless Steel, 250 V, 4 A, -40 °C to +75 °C, male Eurofast PCB pins             | <p><b>Female</b></p>  |
| <p><b>FSFDW 45..</b></p>  |                     |                     |   |   |
| <p><b>FKFDLW 45..</b></p> | <b>FKFDLW 45</b>    | <b>FSFDLW 45</b>    | Nickel plated CuZn or stainless Steel, 250 V, 4 A, -40 °C to +75 °C, male Eurofast solder cups          | <ol style="list-style-type: none"> <li>1. N/C</li> <li>2. GN</li> <li>3. N/C</li> <li>4. RD</li> <li>5. BARE</li> </ol> |
| <p><b>FSFDLW 45..</b></p> |                     |                     |   |   |
| <p><b>WFSW 45..</b></p>   |                     | <b>WFSW 45-PCB</b>  | Nickel plated CuZn or stainless Steel, 250 V, 4 A, -40 °C to +75 °C, male Eurofast right angle PCB pins | <p><b>Male</b></p>  |

We reserve the right to make technical alterations without prior notice.

PROFIBUS®-DP Connectivity

Standard housing material is nickel plated brass "FKFD .."; "FKFDV .." indicates 316 stainless steel.

**Panel Cutout**  
FKFD ... FSFD

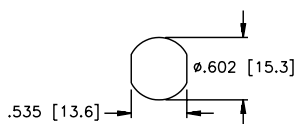

**Board Layout** (reference only)  
FKFD ... FSFD

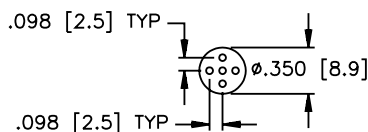

**Panel Cutout**  
WFS

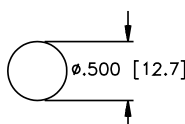

**Board Layout** (reference only)  
WFS

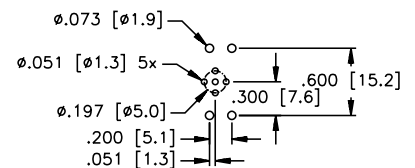

# PROFIBUS® –DP Physical Media Connectivity

## PROFIBUS-DP, Circuit Board Connectors and OEM Receptacles

- Provides (M12x1) Eurofast® Connection to Field Devices



| Housing Style                | Female Part Number    | Male Part Number      | Features  | Pinout               |
|------------------------------|-----------------------|-----------------------|---|----------------------|
| <p><b>FKW 45 PCB KIT</b></p> | <b>FKW 45-PCB KIT</b> | <b>FSW 45-PCB KIT</b> | Nickel plated CuZn or stainless steel, 250 V, 4 A, -30 °C to +75 °C, male Eurofast with mounting kit, reverse key | <p><b>Female</b></p> |
| <p><b>FSW 45 PCB KIT</b></p> |                       |                       |   |                      |
| <p><b>FK 45 PCB</b></p>      | <b>FK 45-PCB</b>      | <b>FSW 45-PCB</b>     | Nickel plated CuZn or stainless steel, 250 V, 4 A, -30 °C to +75 °C, male Eurofast, reverse key                   | <p><b>Male</b></p>   |
| <p><b>FSW 45 PCB</b></p>     |                       |                       |   |                      |

1. N/C
2. GN
3. N/C
4. RD
5. BARE

We reserve the right to make technical alterations without prior notice.

Standard housing material is nickel plated brass "FKFD .."; "FKFDV .." indicates 316 stainless steel.

### Board Layout (reference only) FK ... FS

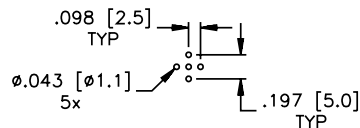

PROFIBUS-DP, Eurofast® Feed Through Receptacle

- Provides Bulkhead Panel Mount Connection



| Housing Style | Part Number                  | Features  | Pinout                                  |
|---------------|------------------------------|---|---|
|               | <p><b>FKW FSW 45/M12</b></p> | <p>Nickel plated brass or stainless steel, 250 V, 4 A, -40 °C to +75 °C, straight male/female connector, for pre-molded reverse keyed Eurofast cables</p> | <p><b>Female</b></p> <p><b>Male</b></p> |

For stainless steel change part number to FKVV FSWV 45/M12

We reserve the right to make technical alterations without prior notice.

PROFIBUS®-DP Connectivity

# PROFIBUS® –DP Physical Media Connectivity

## PROFIBUS-DP, Eurofast® Bus Tees

- Creates a Branch from the Main Bus Line



| Housing Style | Part Number               | Features   | Wiring Diagrams |
|---------------|---------------------------|--|-----------------|
|               | <b>RКСW 2RSSW 45/CM</b>   | TPU, Nickel plated brass, 250 V, 4 A, -40 °C to +75 °C, male Eurofast drop connector, fully shielded Eurofast tee, passive termination |                 |
|               | <b>VB2-FSW/FKW/FSW 45</b> | TPU, Nickel plated brass, 250 V, 4 A, -40 °C to +75 °C, Y Junction, fully shielded Eurofast connectors                                 |                 |

We reserve the right to make technical alterations without prior notice.

### Pinouts

| Eurofast |        |
|----------|--------|
| Male     | Female |
|          |        |

PROFIBUS-DP, Eurofast® Field Wireable Connectors with Labels

- Allows for Quick Connection when Pre-Molded Cables not available
- Available for Male and Female connectors
- Color Coded Wire Connection for PROFIBUS-DP



| Housing Style             | Female Part Number              | Male Part Number                 | Features   | Pinout               |
|---------------------------|---------------------------------|----------------------------------|--|----------------------|
| <p><b>FKFD 57 PCB</b></p> | <p><b>BMWS 8151-8.5/PDP</b></p> | <p><b>BMSWS 8151-8.5/PDP</b></p> | <p>Nickel plated brass, PG 9 cable gland, accepts 4-9 mm cable diameter, screw terminals, accepts up to 18 AWG conductors 85 °C, 125 V, 4 A, mates with reverse key, 5-pin cordsets and receptacles, metal, fully shielded</p> | <p><b>Female</b></p> |
| <p><b>FKFD 57 PCB</b></p> |                                 |                                  |  |                      |
| <p><b>FKFD 57 PCB</b></p> | <p><b>BMWS 8251-8.5/PDP</b></p> | <p><b>BMSWS 8251-8.5/PDP</b></p> | <p>Nickel plated brass, PG 9 cable gland, accepts 4-9 mm cable diameter, screw terminals, accepts up to 18 AWG conductors 85 °C, 125 V, 4 A, mates with reverse key, 5-pin cordsets and receptacles, metal, fully shielded</p> | <p><b>Male</b></p>   |
| <p><b>FKFD 57 PCB</b></p> |                                 |                                  |  |                      |

We reserve the right to make technical alterations without prior notice.

PROFIBUS®-DP Connectivity



|                              |            |
|------------------------------|------------|
| <b>Cordsets</b>              | <b>P22</b> |
| <b>Receptacles</b>           | <b>P24</b> |
| <b>Terminating resistors</b> | <b>P30</b> |
| <b>Tees</b>                  | <b>P31</b> |
| <b>Field Wireables</b>       | <b>P33</b> |

**Features**

- Cable that meets the requirements of ISA/SP 50 and PROFIBUS-PA requirements for Type A Cable
- All cables are rated -40 °C to +105 °C and are sunlight resistant
- Available in 3-wire versions with a device ground or 2-wire versions
- PLTC and ITC listed (CSA FTA)
- Exposed Run (ER) and Direct Burial listed
- IP67 Rated



## PROFIBUS-PA Overview

PROFIBUS-PA (Process Automation) uses synchronous transfer mode technology, as defined in IEC 61158-2, to communicate between field devices and the RS 485 backbone of PROFIBUS®-DP. A segment coupler, or gateway is installed to bridge PROFIBUS-DP with PROFIBUS-PA. Otherwise, the protocols are identical, allowing transparent communication between general purpose automation systems and decentralized field devices.

PROFIBUS-PA is a master-slave bus. Transmitters used in the process industry are typically slave devices or passive stations which only communicate at the request of the master.

## General Layout Topologies

The topology for PROFIBUS-DP is a linear bus. Branching can be accomplished with repeaters or, in the case of PROFIBUS-PA, this can be accomplished with the segment couplers. The PROFIBUS-PA topology follows the physical layer as defined in ISA SP50.02. Daisy chain or star topologies are allowed.

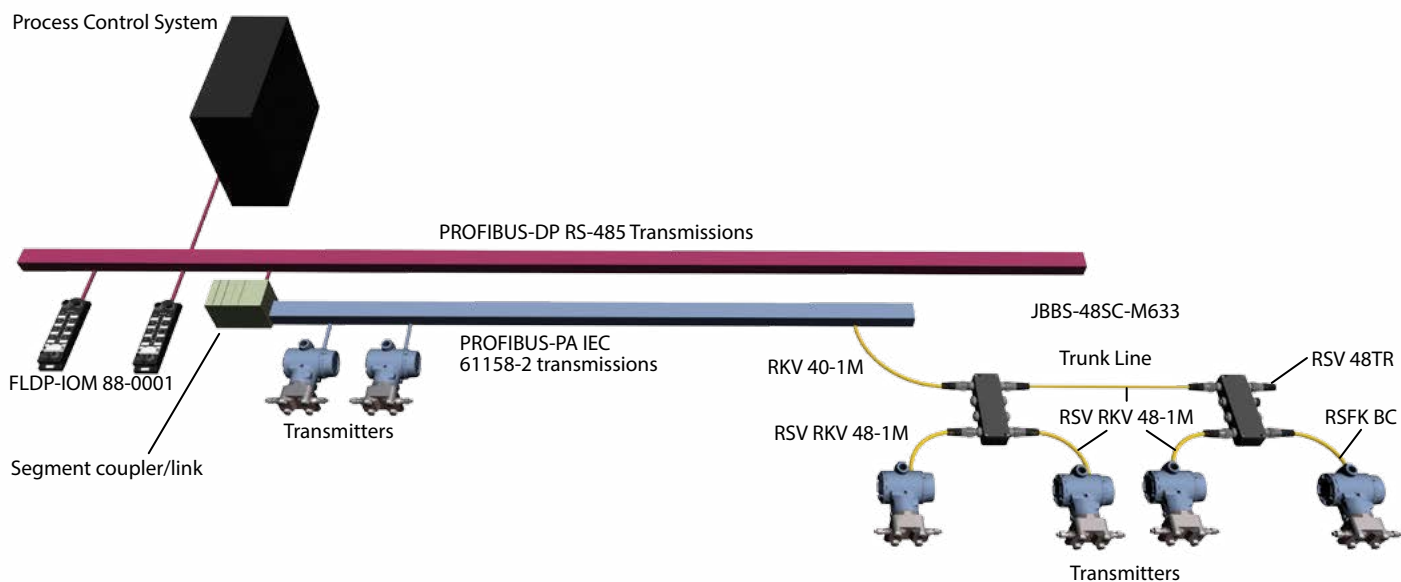



PROFIBUS-PA, Cable Specifications

- Cable that meets the requirements of ISA/SP50 and PROFIBUS-PA requirements for Type A Cable
- All Cables are rated -40 °C to +105 °C and are Sunlight Resistant
- Available in 3-wire versions with a Device Ground or 2-wire versions

Type A Cable Specifications

- Temperature range: -40 °C to +105 °C
- UV Resistant
- PLTC and ITC Listed (CSA FT4)
- Exposed Run (ER) and Direct Buried (DB) Listed
- Maximum Attenuation at 1.25 f<sub>r</sub> (39 kHz) = 3.0 dB/km
- Characteristic Impedance 100 Ω ± 10 Ω @ 31.25 KHz
- Capacitance: 20 pF/Ft nominal
- Inductance: 0.22 μH/Ft. nominal
- Conductor Cross-sectional area (wire size) = nominal 0.75 mm<sup>2</sup> (#18 AWG) or 1.5 mm<sup>2</sup> (#16 AWG)
- Shield Coverage =100 %

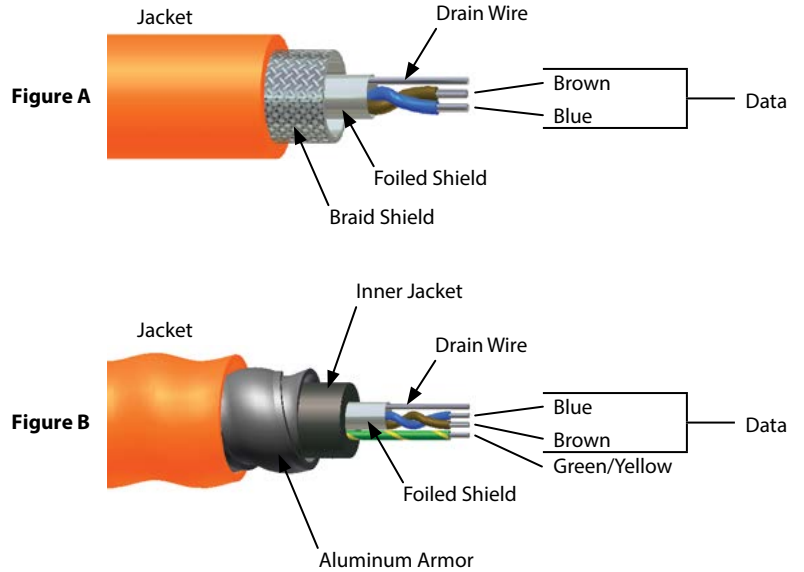

We reserve the right to make technical alterations without prior notice.







PROFIBUS®-PA Connectivity

| Type                          | Approvals                                 | Data Pair      |                             | Device Ground  | Outer Jacket                   | Shields            | Bulk Cable Part Number / Weight/300 M |
|-------------------------------|---|----------------|-----------------------------|----------------|--------------------------------|--------------------|---------------------------------------|
|                               |   | AWG Color Code | DCR (/1000 feet) Insulation | AWG Color Code | Material Color Nominal O.D.    | Type Drain Wire    |                                       |
| <b>483</b><br>105 °C, 600 V   | c(UL) 1309 MS, ITC-ER DB, CIC/TC, FT1 FT4 | 2X18 AWG BU/BN | 7.06 Ohms XLPE              | None           | PVC, ORANGE, 8.5 mm (.335 in)  | Foil/braid, 20 AWG | RB50785-*M, 66 lbs.                   |
| <b>483B</b><br>105 °C, 600 V  | c(UL) 1309 MS, ITC-ER DB, CIC/TC, FT1 FT4 | 2X18 AWG BU/BN | 7.06 Ohms XLPE              | None           | PVC, BLUE, 8.5 mm (.335 in)    | Foil/braid, 20 AWG | RB50786-*M, 66 lbs.                   |
| <b>482A</b><br>105 °C, 300 V  | UL ITC-ER DB CSA ACIC HL-ABCD, FT1 FT4    | 2X18 AWG BU/BN | 7.06 Ohms XLPE              | 18 AWG, GN-YE  | PVC, ORANGE, 15.6 mm (.615 in) | Foil/armor, 20 AWG | RB50929-*M, 184 lbs.                  |
| <b>482BA</b><br>105 °C, 300 V | UL ITC-ER DB CSA ACIC HL-ABCD, FT1 FT4    | 2X18 AWG BU/BN | 7.06 Ohms XLPE              | 18 AWG, GN-YE  | PVC, BLUE, 15.6 mm (.615 in)   | Foil/armor, 20 AWG | RB50803-*M, 184 lbs. Flexlife         |
| <b>483BK</b><br>105 °C, 600 V | c(UL) 1309 MS, ITC-ER DB, CIC/TC, FT1 FT4 | 2X18 AWG BU/BN | 7.06 Ohms XLPE              | None           | PVC, BLACK 8.5 mm (.335 in)    | Foil/braid, 20 AWG | RB50860-*M, 66 lbs.                   |

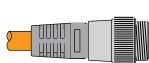
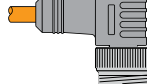
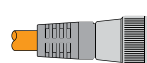
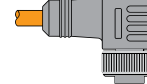
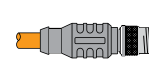
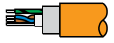
\* Indicates length in meters. Standard spool lengths are 30, 75, 100, 150, 200, 225, 300 meters. Consult factory for other lengths.

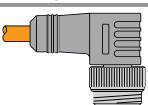
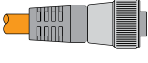
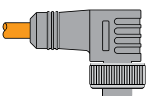
# PROFIBUS® –PA Physical Media Connectivity

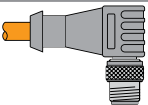
## PROFIBUS-PA, Cable and Cordset Selection Matrix

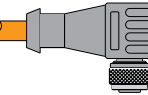
|                   |   | Minifast®   |   |   |   | Eurofast®  |
|-------------------|---|---|---|---|---|--|
|                   |   | (Male)  |   | (Female)  |   | Male   |
|                   |   | <br>1<br>RSV | <br>3<br>WSV | <br>2<br>RKV | <br>4<br>WKV | <br>7<br>RSCV |
|                   | <br>Bare         | RSV 48x-*M  | WSV 48x-*M  | RKV 48x-*M  | WKV 48x-*M  | RSCV 48x-*M  |
| Minifast (Male)   | <br>1<br>RSV     | RSV RSV 48x-*M  | RSV WSV 48x-*M  | RSV RKV 48x-*M  | RSV WKV 48x-*M  | RSV RSCV 48x-*M  |
|                   | <br>3<br>WSV     |   | WSV WSV 48x-*M  | WSV RKV 48x-*M  | WSV WKV 48x-*M  | WSV RSCV 48x-*M  |
| Minifast (Female) | <br>2<br>RKV     |   |   | RKV RKV 48x-*M  | RKV WKV 48x-*M  | RKV RSCV 48x-*M  |
|                   | <br>4<br>WKV    |   |   |   | WKV WKV 48x-*M  | WKV RSCV 48x-*M  |
| Eurofast (Male)   | <br>7<br>RSCV  |   |   |   |   | RSCV RSCV 48x-*M   |
|                   | <br>9<br>WSCV  |   |   |   |   |  |
| Eurofast (Female) | <br>8<br>RKCVC |   |   |   |   |  |
|                   | <br>10<br>WKCV |   |   |   |   |  |

We reserve the right to make technical alterations without prior notice.

See pages P26 - P27 for dimensional drawings.

\* Indicates length in meters.

x Indicates cable type.

Standard cable lengths are 1, 2, 4, 6, 8, 10, 15, and in +5 meter increments from there. Consult factory for other lengths.

PROFIBUS-PA, Cable and Cordset Selection Matrix

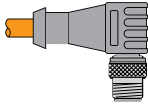
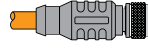
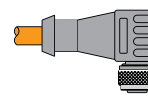
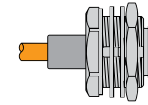
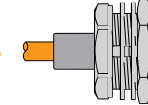
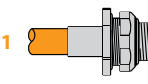
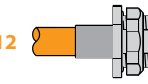
| Eurofast®   |   |  | Minifast® Bulkhead   |   | Eurofast Bulkhead   |   |
|---|---|--|--|---|---|---|
| Male  | Female  |  | Male   | Female  | Male  | Female  |
|  9<br>WSCV |  8<br>RKCX |  10<br>WKCX |  5<br>RSFPV |  6<br>RKFPV |  11<br>FSFDV |  12<br>FKFDV |
| WSCV 48x-*M   | RKCX 48x-*M   | WKCX 48x-*M  | RSFPV 48x-*M   | RKFPV 48x-*M  | FSFDV 48x-*M  | FKFDV 48x-*M  |
| RSV WSCV 48x-*M   | RSV RKCX 48x-*M   | RSV WKCX 48x-*M  | RSV RSFPV 48x-*M   | RSV RKFPV 48x-*M  | RSV FSFDV 48x-*M  | RSV FKFDV 48x-*M  |
| WSV WSCV 48x-*M   | WSV RKCX 48x-*M   | WSV WKCX 48x-*M  | WSV RSFPV 48x-*M   | WSV RKFPV 48x-*M  | WSV FSFDV 48x-*M  | WSV FKFDV 48x-*M  |
| RKV WSCV 48x-*M   | RKV RKCX 48x-*M   | RKV WKCX 48x-*M  | RKV RSFPV 48x-*M   | RKV RKFPV 48x-*M  | RKV FSFDV 48x-*M  | RKV FKFDV 48x-*M  |
| WKV WSCV 48x-*M   | WKV RKCX 48x-*M   | WKV WKCX 48x-*M  | WKV RSFPV 48x-*M   | WKV RKFPV 48x-*M  | WKV FSFDV 48x-*M  | WKV FKFDV 48x-*M  |
| RSCV WSCV 48x-*M  | RSCV RKCX 48x-*M  | RSCV WKCX 48x-*M   | RSCV RSFPV 48x-*M  | RSCV RKFPV 48x-*M   | RSCV FSFDV 48x-*M   | RSCV FKFDV 48x-*M   |
| WSCV WSCV 48x-*M  | WSCV RKCX 48x-*M  | WSCV WKCX 48x-*M   | WSCV RSFPV 48x-*M  | WSCV RKFPV 48x-*M   | WSCV FSFDV 48x-*M   | WSCV FKFDV 48x-*M   |
|   | RKCX RKCX 48x-*M  | RKCX WKCX 48x-*M   | RKCX RSFPV 48x-*M  | RKCX RKFPV 48x-*M   | RKCX FSFDV 48x-*M   | RKCX FKFDV 48x-*M   |
|   |   | WKCX WKCX 48x-*M   | WKCX RSFPV 48x-*M  | WKCX RKFPV 48x-*M   | WKCX FSFDV 48x-*M   | WKCX FKFDV 48x-*M   |

We reserve the right to make technical alterations without prior notice.

PROFIBUS®-PA Connectivity

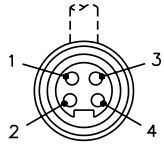
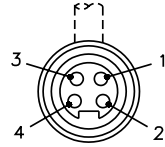
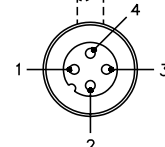
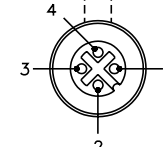
| Minifast  |   | Pinouts  | Eurofast  |   |
|---|---|--|---|---|
| Male  | Female  |  | Male  | Female  |
|  |  | 1. Brown (+ Voltage)<br>2. N/C<br>3. Blue (- Voltage)<br>4. Bare (Shield Drain Wire) |  |  |

**Specifications**

|                         |                                       |                             |                                       |
|-------------------------|---------------------------------------|-----------------------------|---------------------------------------|
| <b>Overmold:</b>        | TPU                                   | <b>Protection:</b>          | NEMA 1, 3, 4, 6P and IEC IP 68        |
| <b>Coupling Nut:</b>    | Nickel Plated CuZn or Stainless Steel | <b>Rated Voltage:</b>       | 300 V                                 |
| <b>Contact Carrier:</b> | TPU                                   | <b>Rated Current:</b>       | 9 A                                   |
| <b>Contacts:</b>        | Gold Plated CuZn                      | <b>Ambient Temperature:</b> | -40 °C to +105 °C (-40 °F to +221 °F) |

1

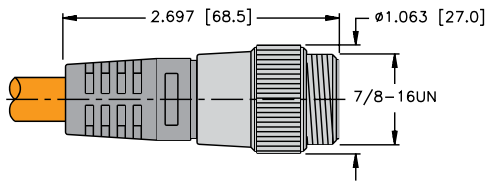

RSV ..

Page P22

2

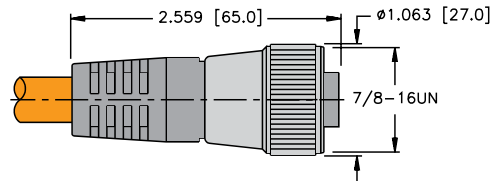

RKV ..

Page P22

3

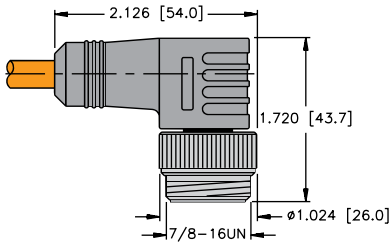

WSV ..

Page P22

4

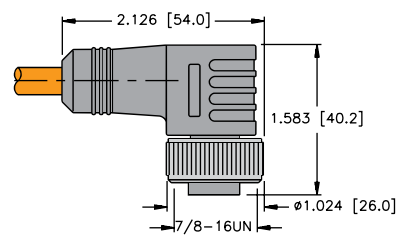

WKV ..

Page P22

5

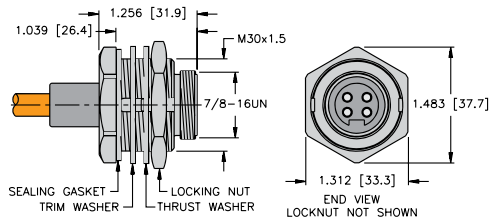

RSFPV ..

Page P23

6

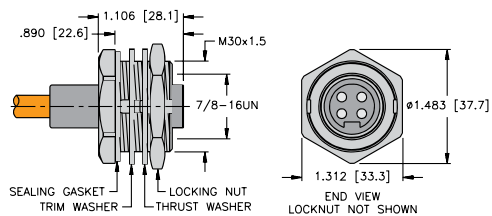

RKFPV ..

Page P23

We reserve the right to make technical alterations without prior notice.

Specifications

|                         |                                       |                             |                                       |
|-------------------------|---------------------------------------|-----------------------------|---------------------------------------|
| <b>Overmold:</b>        | TPU                                   | <b>Protection:</b>          | NEMA 1, 3, 4, 6P and IEC IP 68        |
| <b>Coupling Nut:</b>    | Nickel Plated CuZn or Stainless Steel | <b>Rated Voltage:</b>       | 250 V                                 |
| <b>Contact Carrier:</b> | TPU or POM (Nylon)                    | <b>Rated Current:</b>       | 4 A                                   |
| <b>Contacts:</b>        | Gold Plated CuZn                      | <b>Ambient Temperature:</b> | -40 °C to +105 °C (-40 °F to +221 °F) |

7

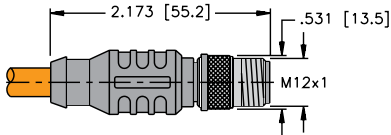

RSCV ..

Page P22

8

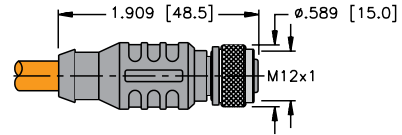

RKCV ..

Page P22

9

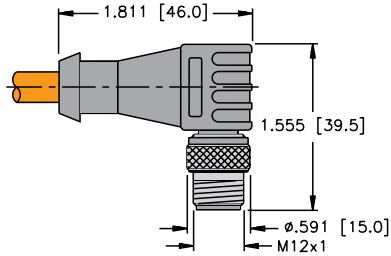

WSCV ..

Page P22

10

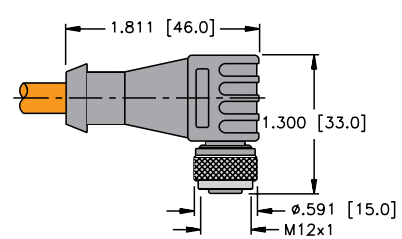

WKCV ..

Page P22

11

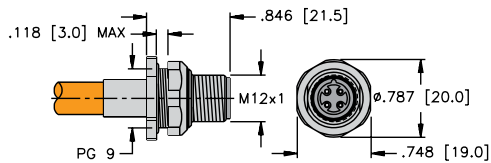

FSFDV ..

Page P23

12

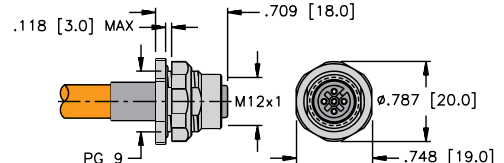

FKFDV ..

Page P23

We reserve the right to make technical alterations without prior notice.

PROFIBUS®-PA Connectivity

# PROFIBUS® –PA Physical Media Connectivity

## PROFIBUS-PA, (7/8-16 UN) Minifast® Male Receptacles

- Provides Quick Connection to Field Devices
- Available for 1/2-14 NPT, 1/2-14 NPSM, 3/4-14 NPT and M20 Threads



| Housing Style                  | Female Part Number      | Male Part Number        | Features  | Pinout  |
|--------------------------------|-------------------------|-------------------------|---|---|
| <p><b>RKFV 48-*M/14.5</b></p>  | <b>RKFV 48-*M/14.5</b>  | <b>RSFV 48-*M/14.5</b>  | Nickel Plated CuZn or Stainless Steel 600 V, 9 A, -40 °C to +105 °C, 1/2-14 NPT full length threads | <p><b>Female</b></p>  |
| <p><b>RSFV 48-*M/14.5</b></p>  |                         |                         |   |   |
| <p><b>RKFV 48-*M/14.75</b></p> | <b>RKFV 48-*M/14.75</b> | <b>RSFV 48-*M/14.75</b> | Nickel Plated CuZn or Stainless Steel 600 V, 9 A, -40 °C to +105 °C, 3/4-14 NPT full length threads | <ol style="list-style-type: none"> <li>1. BN</li> <li>2. N/C</li> <li>3. BU</li> <li>4. GY</li> </ol> |
| <p><b>RSFV 48-*M/14.75</b></p> |                         |                         |   |   |
| <p><b>RKFV 48-*M/M20</b></p>   | <b>RKFV 48-*M/M20</b>   | <b>RSFV 48-*M/M20</b>   | Nickel Plated CuZn or Stainless Steel 600 V, 9 A, -40 °C to +105 °C, M20x1.5 threads                | <p><b>Male</b></p>  |
| <p><b>RSFV 48-*M/M20</b></p>   |                         |                         |   |   |

We reserve the right to make technical alterations without prior notice.

Standard cable length is 0.5 meters. Consult factory for other lengths  
 Standard housing material is nickel plated brass. "RKFV .."; indicates 316 stainless steel housing.  
 For locknuts to be included, add "W/LN" to the end of the part number.

PROFIBUS-PA, (7/8-16 UN) Minifast® Female Receptacles

- Provides Quick Connection to Field Devices
- Available for 1/2-14 NPT, 1/2-14 NPSM, 3/4-14 NPT and M20 Threads



| Housing Style            | Female Part Number | Male Part Number  | Features   | Pinout               |
|--------------------------|--------------------|-------------------|--|----------------------|
| <p><b>RKFV 48-*M</b></p> | <b>RKFV 48-*M</b>  | <b>RSFV 48-*M</b> | Nickel Plated CuZn or Stainless Steel 600 V, 9 A, -40 °C to +105 °C, 1/2-14 NPSM threads | <p><b>Female</b></p> |
| <p><b>RSFV 48-*M</b></p> |                    |                   |  | <p><b>Male</b></p>   |

Standard cable length is 0.5 meters. Consult factory for other lengths  
 Standard housing material is nickel plated brass. "RKFV .."; indicates 316 stainless steel housing.  
 For locknuts to be included, add "W/LN" to the end of the part number.

We reserve the right to make technical alterations without prior notice.

PROFIBUS®-PA Connectivity

# PROFIBUS® –PA Physical Media Connectivity

## PROFIBUS-PA, (M12x1) Eurofast® Male Receptacles

- Mounted Quick Connection to Enclosures
- Available for 1/2-14 NPT, 1/2-14 NPSM, 3/4-14 NPT and M20 Threads



| Housing Style                 | Female Part Number     | Male Part Number       | Features  | Pinout  |
|-------------------------------|------------------------|------------------------|---|---|
| <p><b>FKV 48-*M/14.5</b></p>  | <b>FKV 48-*M/14.5</b>  | <b>FSV 48-*M/14.5</b>  | Nickel Plated CuZn or Stainless Steel 250 V, 4 A, -40 °C to +105 °C, 1/2-14 NPT full length threads | <p><b>Female</b></p>  |
| <p><b>FSV 48-*M/14.5</b></p>  |                        |                        |   |   |
| <p><b>FKV 48-*M/14.75</b></p> | <b>FKV 48-*M/14.75</b> | <b>FSV 48-*M/14.75</b> | Nickel Plated CuZn or Stainless Steel 250 V, 4 A, -40 °C to +105 °C, 3/4-14 NPT full length threads | <ol style="list-style-type: none"> <li>1. BN</li> <li>2. N/C</li> <li>3. BU</li> <li>4. GY</li> </ol> |
| <p><b>FSV 48-*M/14.75</b></p> |                        |                        |   |   |
| <p><b>FKV 48-*M</b></p>       | <b>FKV 48-*M/M20</b>   | <b>FSV 48-*M/M20</b>   | Nickel Plated CuZn or Stainless Steel 250 V, 4 A, -40 °C to +105 °C, M20x1.5 threads                | <p><b>Male</b></p>  |
| <p><b>FKV 48-*M</b></p>       |                        |                        |   |   |

We reserve the right to make technical alterations without prior notice.

Standard cable length is 0.5 meters. Consult factory for other lengths  
 Standard housing material is nickel plated brass. "RKFV .."; indicates 316 stainless steel housing.



PROFIBUS-PA, (M12x1) Eurofast® Female Receptacles

- Mounted Quick Connection to Enclosures
- Available for 1/2-14 NPT, 1/2-14 NPSM, 3/4-14 NPT and M20 Threads



| Housing Style           | Female Part Number | Male Part Number | Features  | Pinout               |
|-------------------------|--------------------|------------------|---|----------------------|
| <p><b>FKV 48-*M</b></p> | <b>FKV 48-*M</b>   | <b>FSV 48-*M</b> | Nickel Plated CuZn or Stainless Steel 250 V, 4 A, -40 °C to +105 °C, PG 9 threads | <p><b>Female</b></p> |
| <p><b>FSV 48-*M</b></p> |                    |                  |   | <p><b>Male</b></p>   |

Standard cable length is 0.5 meters. Consult factory for other lengths  
 Standard housing material is nickel plated brass. "RKFV .."; indicates 316 stainless steel housing.

We reserve the right to make technical alterations without prior notice.

PROFIBUS®-PA Connectivity

# PROFIBUS® –PA Physical Media Connectivity

## PROFIBUS-PA, Terminating Resistors

- Terminating Resistors stabilize and minimize reflections on the Bus Line
- A Terminating Resistor is required at the beginning and end of the Main Bus Line



| Housing Style | Part Number       | Features   | Pinout             |
|---------------|-------------------|--|--------------------|
|               | <b>RSV 48 TR</b>  | Nickel plated brass or stainless steel, 300 V, 9 A, -40 °C to +75 °C, male Minifast® connector | <p><b>Male</b></p> |
|               | <b>RSEV 48-TR</b> | Nickel plated brass or stainless steel, 250 V, 4 A, -40 °C to +75 °C, male Eurofast® connector | <p><b>Male</b></p> |

## PROFIBUS-PA, Feed Through Connectors

- Receptacles provide transition from Male to Female Connectors
- Available for Bulkhead and Feed Through applications



| Housing Style | Part Number            | Features  | Pinout                                |
|---------------|------------------------|---|---------------------------------------|
|               | <b>RSFV RKFV 48/22</b> | Stainless steel, 300 V, 9 A, -40 °C to +75 °C, straight male/female feed through, for use with molded Minifast cordsets | <p><b>Female</b>      <b>Male</b></p> |
|               | <b>FKV FSV 48/M12</b>  | Stainless steel, 250 V, 4 A, -40 °C to +75 °C, straight male/female connector, for pre-molded Eurofast cables           | <p><b>Female</b>      <b>Male</b></p> |

### Panel Cutout RSFV RKFV 48/22

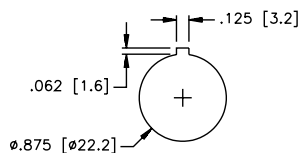

### Panel Cutout WFS

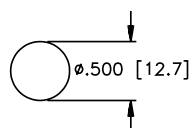

We reserve the right to make technical alterations without prior notice.

PROFIBUS-PA, Tees

- Creates a Drop or Branch from the Main Bus Line
- Minifast® Connectors on Bus or Drop Lines



| Housing Style | Part Number           | Features   | Wiring Diagrams |
|---------------|-----------------------|--|-----------------|
|               | <b>RSV-2RKV 48</b>    | TPU, 250 V, 4 A, -40 °C to +75 °C, data, ground, shield, stainless steel, coupling nuts                            |                 |
|               | <b>RSV FKV RKV 48</b> | TPU, 250 V, 4 A, -40 °C to +75 °C, Minifast to Eurofast® drop, data, ground, shield, stainless steel coupling nuts |                 |
|               | <b>RSCV RKCVC 48</b>  | TPU, 250 V, 4 A, -40 °C to +105 °C, stainless steel coupling nuts  |                 |

We reserve the right to make technical alterations without prior notice.

PROFIBUS®-PA Connectivity

Pinouts

| Minifast |        | Eurofast |        |
|----------|--------|----------|--------|
| Male     | Female | Male     | Female |
|          |        |          |        |

# PROFIBUS® –PA Physical Media Connectivity

## PROFIBUS-PA, Gender Changer

- Allows quick and easy changes from Male to Female Minifast® from Connectors



| Housing Style | Part Number | Features   |
|---------------|-------------|--|
|               | RKV RKV 48  | TPU, 250 V, 4 A, -40 °C to +75 °C, changes female cordset to male receptacle |

## PROFIBUS-PA, Conversion Connector

- Allows Quick and Easy Changes from Minifast® to Eurofast® Connectors



| Housing Style | Part Number   | Features   | Wiring Diagrams |
|---------------|---------------|--|-----------------|
|               | RSM 48-FK 4.4 | Nickel plated brass CuZn or Stainless Steel, 250 V, 4 A, -40 °C to +80 °C, female Eurofast, male Minifast, 4-pin |                 |

We reserve the right to make technical alterations without prior notice.

### Pinouts

| Minifast |        | Eurofast |
|----------|--------|----------|
| Male     | Female | Female   |
|          |        |          |

PROFIBUS-PA, Minifast® Field Wireable Connectors

- Screw Terminals accept up to 16 AWG Conductors



We reserve the right to make technical alterations without prior notice.

| Housing Style           | Female Part Number   | Female Part Number   | Features  | Pinout               |
|-------------------------|----------------------|----------------------|---|----------------------|
| <p><b>BK 414..</b></p>  | <b>BK 4140-0/9</b>   | <b>BS 4140-0/9</b>   | Plastic, TPU (cable grip: Plastic, PU), Anodized Aluminum, PG 0/9 cable gland accepts 6-8 mm cable diameter, -40 °C to +90 °C (-40 °F to +194 °F), 250 V, 9 A, mates with all 4-pin Minifast cordsets and receptacles | <p><b>Female</b></p> |
| <p><b>BS 414..</b></p>  |                      |                      |   |                      |
| <p><b>BSV 414..</b></p> | <b>BKV 4140-0/9</b>  | <b>BSV 4140-0/9</b>  | Glass filled nylon, stainless steel coupling nut, PG 0/9 cable gland accepts 6-8 mm cable diameter, -40 °C to +90 °C (-40 °F to +194 °F), 300 V, 9 A, mates with all 4-pin Minifast cordsets and receptacles          | <p><b>Male</b></p>   |
| <p><b>BKV 414..</b></p> |                      |                      |   |                      |
| <p><b>BKV 414..</b></p> | <b>BKV 4140-0/16</b> | <b>BSV 4140-0/16</b> | Glass filled nylon, stainless steel coupling nut, PG 16 cable gland accepts 10-12 mm cable diameter, -40 °C to +90 °C (-40 °F to +194 °F), 600 V, 9 A, mates with all 4-pin Minifast cordsets and receptacles         | <p><b>Male</b></p>   |
| <p><b>BSV 414..</b></p> |                      |                      |   |                      |

PROFIBUS®-PA Connectivity

# PROFIBUS® –PA Physical Media Connectivity

## PROFIBUS-PA, Eurofast® Field Wireable Connectors

- Screw Terminals accept up to 18 AWG Conductors



| Housing Style                                | Female Part Number  | Female Part Number   | Features  | Pinout               |
|--|---------------------|----------------------|---|----------------------|
| <p><b>B 814..</b></p> <p><b>BS 814..</b></p> | <b>B 8141-0/PG9</b> | <b>BS 8141-0/PG9</b> | PBT, Black, PG 9 cable gland, accepts 4-8 mm cable diameter, 85 °C, 125 V, 4 A, mates with standard key 4-pin Eurofast cordsets and receptacles | <p><b>Female</b></p> |
| <p><b>B 824..</b></p> <p><b>BS 824..</b></p> | <b>B 8241-0/PG9</b> | <b>BS 8241-0/PG9</b> | PBT, Black, PG 9 cable gland, accepts 4-8 mm cable diameter, 85 °C, 125 V, 4 A, mates with standard key 4-pin Eurofast cordsets and receptacles | <p><b>Male</b></p>   |

We reserve the right to make technical alterations without prior notice.

|                         |            |
|-------------------------|------------|
| <b>Part Number Keys</b> | <b>R4</b>  |
| <b>Cordsets</b>         | <b>R7</b>  |
| <b>Receptacles</b>      | <b>R15</b> |
| <b>Field Wireables</b>  | <b>R19</b> |
| <b>Accessories</b>      | <b>R21</b> |

## Features

- Cables that meet the requirements of EN 50295 for communication up to 167 KBAUD
- ITC-ER/PLTC-ER rated cable (CSA FT4)
- Oil resistant II and sunlight resistant
- 7/8 and M12 connectors
- Up to 9 Amps and 600 Volt rated
- IP67/IP69K rated



## AS-interface System Description

AS-interface (commonly referred to as AS-I) is a low-level I/O interface system. It was originally intended to be a simple, low cost system that would be easy to install and maintain. With that philosophy in mind, the original developers designed AS-I as a discrete-only two-wire system. It incorporated features like automatic station addressing, and power and data were carried on a single untwisted pair of wires.

As the demand for AS-I grew, so did the demand for more complex devices. The next major version of AS-I, v2.1, extended the protocol to include seamless transfer of analog data, transmission of simple diagnostic data, and an extended addressing scheme that effectively doubled the number of stations allowed on the network. The newest version of AS-I, v3.0, has gone even further, allowing more options for analog data and much more detailed diagnostic information to be communicated. New versions of AS-I are backward compatible and support slaves from earlier versions. Additionally, AS-I was one of the first network systems to incorporate a safety protocol, allowing emergency-stop and machine-stop systems to be seamlessly integrated with the network.

AS-I can be used as a stand alone network or can be connected to a higher level system, such as DeviceNet™ or PROFIBUS®-DP, through a gateway. The gateway acts as a slave to the higher system and a master to the AS-I system.

### Cordsets

Turck offers a complete line of molded AS-I cordsets to facilitate network installation, resulting in a faster start-up and fewer wiring errors. The bus and drop cables are specially designed foil-shielded, high-flex cables with very low inductance and capacitance to minimize propagation delay time. AS-I cables consist of a single untwisted and unshielded wire pair that carries both 30 VDC power and the network data. AS-I was originally designed for use with flat cable using an insulation displacement connection technology, but the use of round cables with sealed connectors has become more common. Turck provides both cable options.

### Maximum Ratings

The AS-I system uses a freeform layout topology. Up to 100 m of cable can be used on a segment before a repeater or tuner needs to be installed to allow the network to be extended beyond the 100 m limit. No terminating resistors are required.



## Typical System Configuration

### Basic Parts List

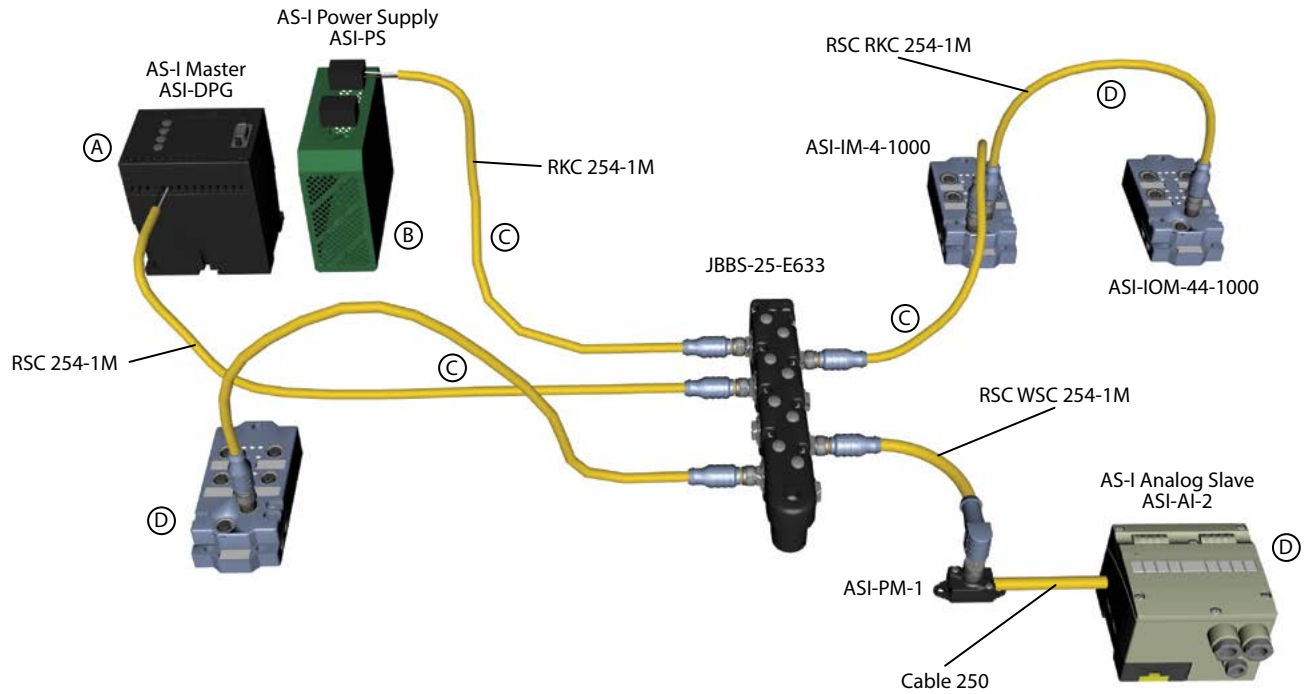

A typical AS-I system consists of the following parts:

- A - Master
- B - AS-I Power Supply
- C - AS-I Cable (See N2)
- D - AS-I I/O Modules (or Slaves)

AS-I stations require a network master (also called a scanner) to interface the stations to the host controller. In some cases the scanner and controller are packaged as a single unit; in other cases the scanner acts as a gateway to a higher level network or to a PLC. Turck AS-I stations are designed to be fully compatible with AS-I equipment from other manufacturers.

# AS-interface® Physical Media Connectivity

## Minifast® Cordset Part Number Key

Part Number Keys are to assist in IDENTIFICATION ONLY. Consult factory for catalog items not identified.

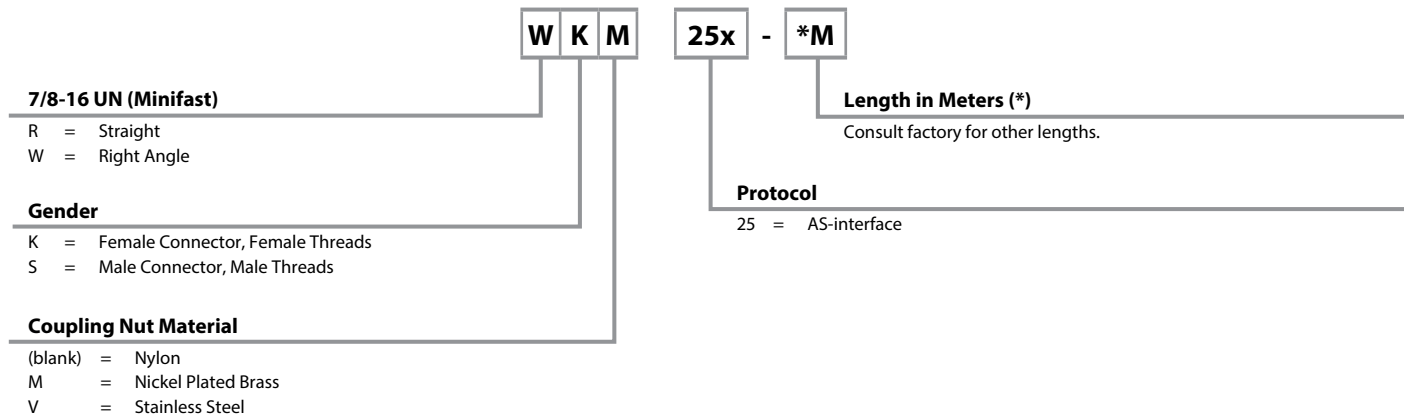

## Minifast Receptacle Part Number Key

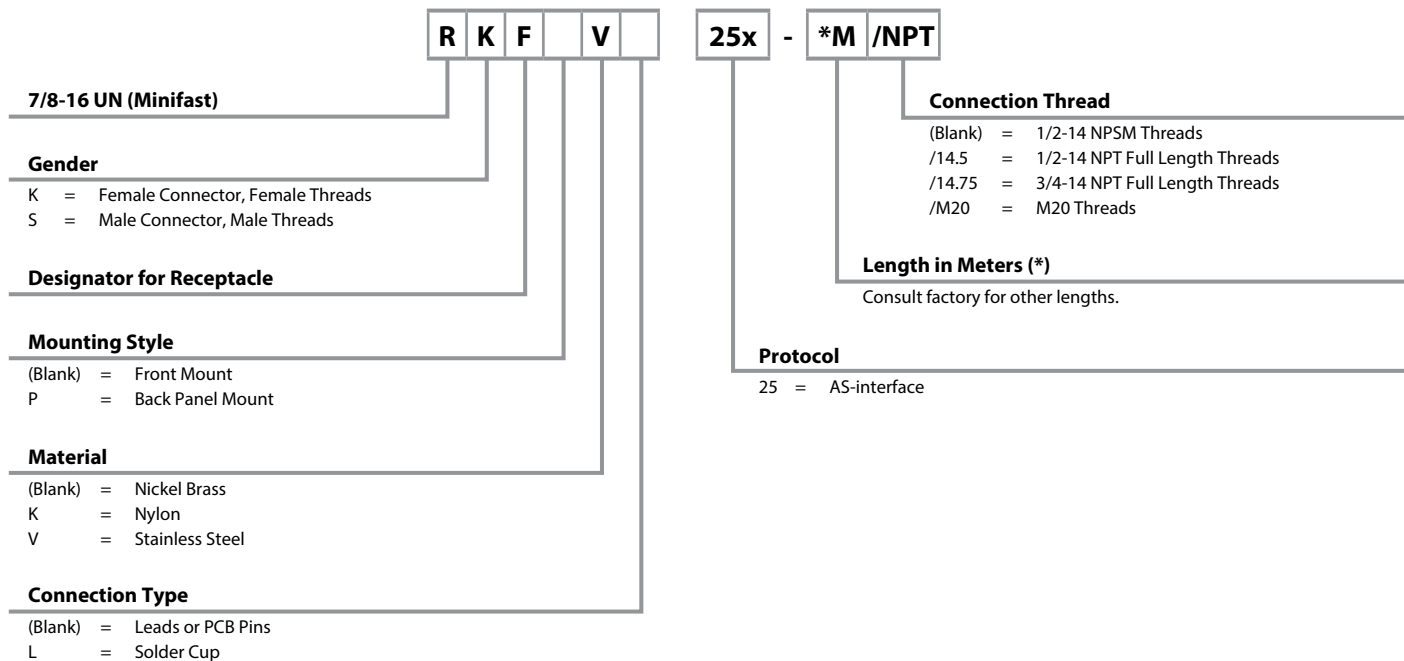

## Eurofast® Cordset Part Number Key

Part Number Keys are to assist in IDENTIFICATION ONLY. Consult factory for catalog items not identified.

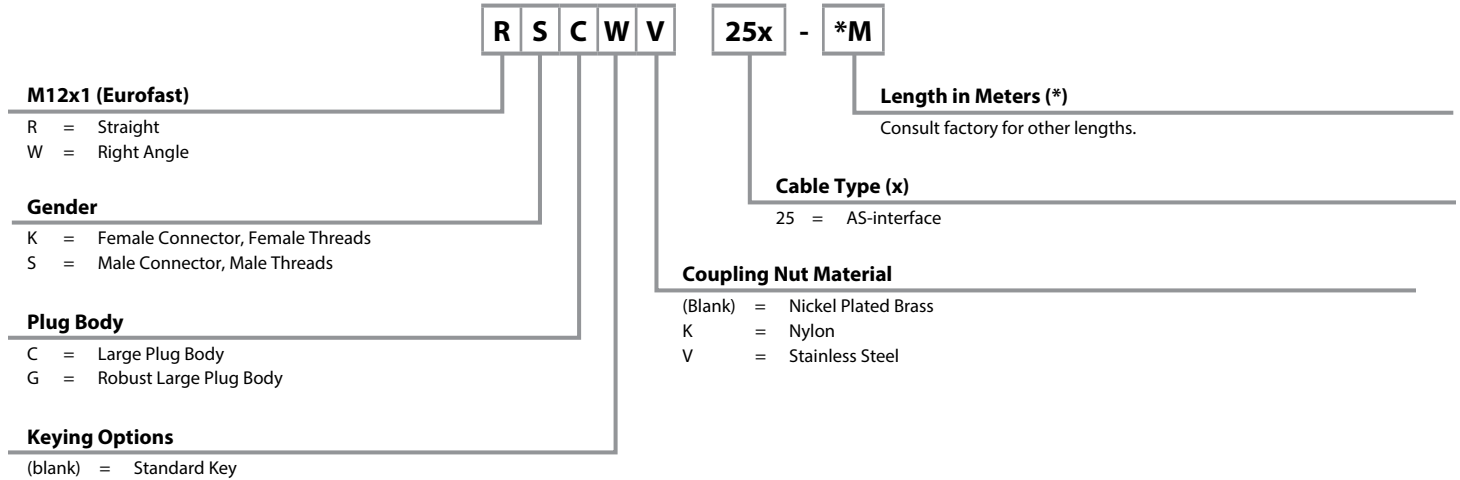

## Eurofast Receptacle Part Number Key

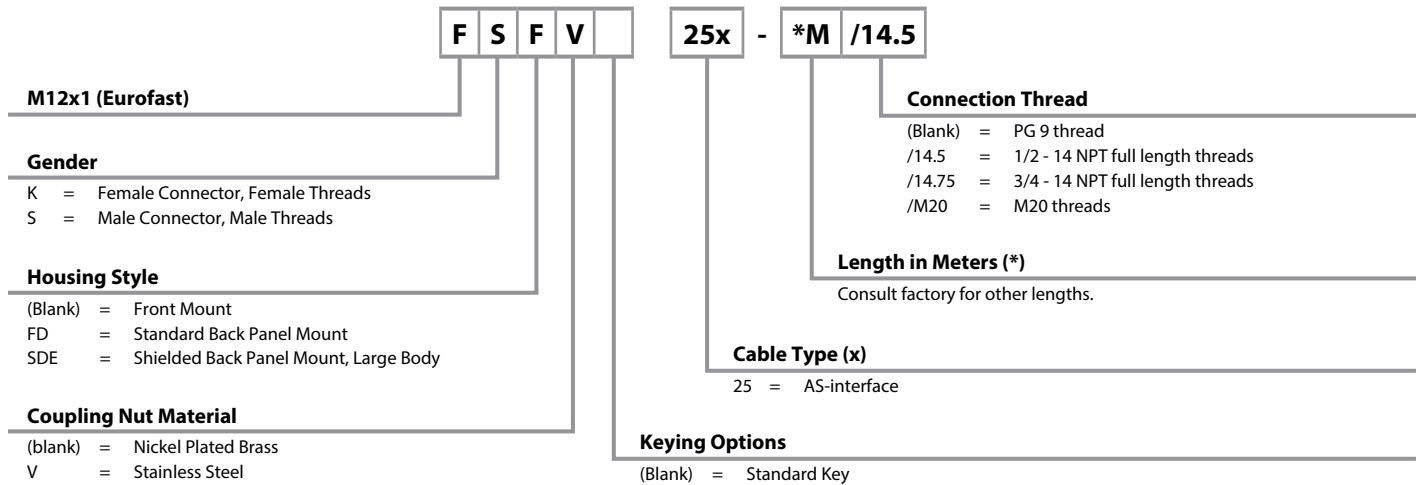



## AS-interface, Cable Specifications

- AS-interface Cable that meets the requirements of EN50295e for communication up to 167 Kbaud
- Maximum cable length per segment is 100 meters

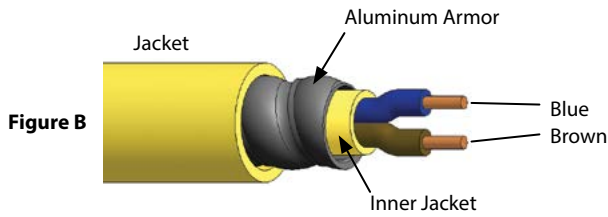
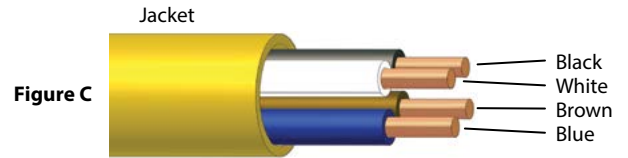
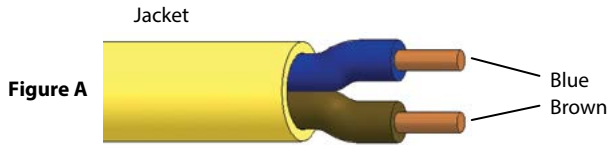

We reserve the right to make technical alterations without prior notice.



| Type                          | Approvals                                    | Data Pair               |                             | Outer Jacket                               | Bulk Cable Part Number / Weight/300 M |
|-------------------------------|--|-------------------------|-----------------------------|--|---------------------------------------|
|                               |  | AWG Color Code          | DCR (/1000 feet) Insulation | Material Color Nominal O.D.                |                                       |
| <b>254</b><br>105 °C, 600 V   | c(UL) 1309 MS, ITC-ER DB, CIC/TC, FT1 FT4    | 2X16 AWG<br>BU/BN       | 4.1 Ohms<br>PVC             | PVC, YELLOW,<br>7.2 mm (.285 in)           | RB50852-*M,<br>49 lbs.                |
| <b>254BK</b><br>105 °C, 600 V | c(UL) 1309 MS, ITC-ER DB, CIC/TC, FT1 FT4    | 2X16 AWG<br>BU/BN       | 4.1 Ohms<br>PVC             | PVC, BLACK,<br>7.2 mm (.285 in)            | RB51029-*M,<br>49 lbs.                |
| <b>254B</b><br>105 °C, 600 V  | c(UL) 1309 MS, ITC-ER DB, CIC/TC, FT1 FT4    | 2X16 AWG<br>BU/BN       | 4.1 Ohms<br>PVC             | PVC, BLUE,<br>7.2 mm (.285 in)             | RB50962-*M,<br>49 lbs.                |
| <b>255A</b><br>105 °C, 300 V  | UL ITC-ER DB<br>CSA ACIC HL-ABCD,<br>FT1 FT4 | 2X16 AWG<br>BU/BN       | 4.1 Ohms<br>PVC             | Armor,<br>PVC YELLOW,<br>15.2 mm (.600 in) | RB50966-*M,<br>173 lbs.               |
| <b>2544</b><br>105 °C, 600 V  | c(UL) 1309 MS, ITC-ER DB, CIC/TC, FT1 FT4    | 4X16 AWG<br>BN/WH/BU/BK | 4.1 Ohms<br>PVC             | PVC, YELLOW,<br>8.5 mm (.335 in)           | RB51875-*M,<br>81 lbs.                |

\* Indicates length in meters.  
Standard spool lengths are 30, 75, 100, 150, 200, 225, 300 meters. Consult factory for other lengths.

AS-interface® Media

# AS-interface® Physical Media Connectivity

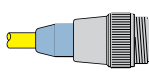
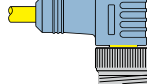
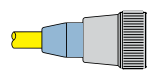
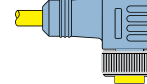
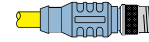
## AS-interface, Cable and Cordset Selection Matrix

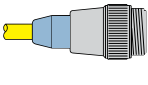
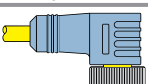
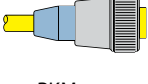
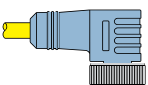
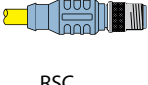
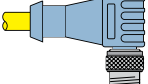
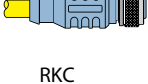
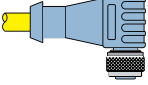
|   |   | Minifast®  |  |  |  | Eurofast®  |
|---|---|--|--|--|--|--|
|   |   | Male   |  | Female   |  | Male   |
|   |   | 1 <br>RSM | 2 <br>WSM | 3 <br>RKM | 4 <br>WKM | 7 <br>RSC |
| <br>Bare |   | RSM 25x-*M   | WSM 25x-*M   | RKM 25x-*M   | WKM 25x-*M   | RSC 25x-*M   |
| Minifast (Male)   | 1 <br>RSM    | RSM RSM 25x-*M   | RSM WSM 25x-*M   | RSM RKM 25x-*M   | RSM WKM 25x-*M   | RSM RSC 25x-*M   |
|   | 2 <br>WSM    |  | WSM WSM 25x-*M   | WSM RKM 25x-*M   | WSM WKM 25x-*M   | WSM RSC 25x-*M   |
| Minifast (Female)   | 3 <br>RKM    |  |  | RKM RKM 25x-*M   | RKM WKM 25x-*M   | RKM RSC 25x-*M   |
|   | 4 <br>WKM   |  |  |  | WKM WKM 25x-*M   | WKM RSC 25x-*M   |
| Eurofast (Male)   | 7 <br>RSC  |  |  |  |  | RSC RSC 25x-*M   |
|   | 8 <br>WSC  |  |  |  |  |  |
| Eurofast (Female)   | 9 <br>RKC  |  |  |  |  |  |
|   | 10 <br>WKC |  |  |  |  |  |

We reserve the right to make technical alterations without prior notice.

See pages R10 - R11 for dimensional drawings.

\* Indicates length in meters.

x Indicates cable type.

Standard cable lengths are 1, 2, 4, 6, 8, 10, 15...50 meters. Consult factory for other lengths.

For stainless steel coupling nuts change part number RSM ... to RSV, WSM ... to WSV. For Eurofast Armorfast® cable RSC ... to RSA.

## AS-interface, Cable and Cordset Selection Matrix

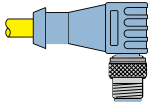
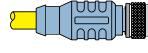
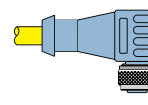
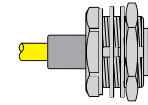
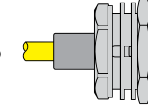
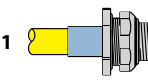
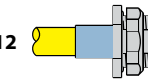
| Eurofast®   |   |  | Minifast® Bulkhead  |  | Eurofast Bulkhead  |  |
|---|---|--|---|--|--|--|
| Male  | Female  |  | Male  | Female   | Male   | Female   |
| 8  | 9  | 10  | 5  | 6  | 11  | 12  |
| WSC   | RKC   | WKC  | RSFP  | RKFP   | FSFD   | FKFD   |
| WSC 25x-*M  | RKC 25x-*M  | WKC 25x-*M   | RSFP 25x-*M   | RKFP 25x-*M  | FSFD 25x-*M  | FKFD 25x-*M  |
| RSM WSC 25x-*M  | RSM RKC 25x-*M  | RSM WKC 25x-*M   | RSM RSFP 25x-*M   | RSM RKFP 25x-*M  | RSM FSFD 25x-*M  | RSM FKFD 25x-*M  |
| WSM WSC 25x-*M  | WSM RKC 25x-*M  | WSM WKC 25x-*M   | WSM RSFP 25x-*M   | WSM RKFP 25x-*M  | WSM FSFD 25x-*M  | WSM FKFD 25x-*M  |
| RKM WSC 25x-*M  | RKM RKC 25x-*M  | RKM WKC 25x-*M   | RKM RSFP 25x-*M   | RKM RKFP 25x-*M  | RKM FSFD 25x-*M  | RKM FKFD 25x-*M  |
| WKM WSC 25x-*M  | WKM RKC 25x-*M  | WKM WKC 25x-*M   | WKM RSFP 25x-*M   | WKM RKFP 25x-*M  | WKM FSFD 25x-*M  | WKM FKFD 25x-*M  |
| RSC WSC 25x-*M  | RSC RKC 25x-*M  | RSC WKC 25x-*M   | RSC RSFP 25x-*M   | RSC RKFP 25x-*M  | RSC FSFD 25x-*M  | RSC FKFD 25x-*M  |
| WSC WSC 25x-*M  | WSC RKC 25x-*M  | WSC WKC 25x-*M   | WSC RSFP 25x-*M   | WSC RKFP 25x-*M  | WSC FSFD 25x-*M  | WSC FKFD 25x-*M  |
|   | RKC RKC 25x-*M  | RKC WKC 25x-*M   | RKC RSFP 25x-*M   | RKC RKFP 25x-*M  | RKC FSFD 25x-*M  | RKC FKFD 25x-*M  |
|   |   | WKC WKC 25x-*M   | WKC RSFP 25x-*M   | WKC RKFP 25x-*M  | WKC FSFD 25x-*M  | WKC FKFD 25x-*M  |

We reserve the right to make technical alterations without prior notice.

AS-interface® Media

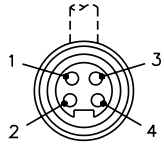
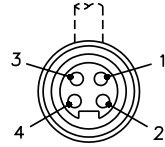
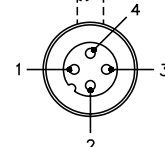
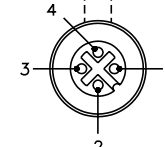
| Minifast  |   | Pinouts   | Eurofast  |   |
|---|---|---|---|---|
| Male  | Female  |   | Male  | Female  |
|  |  | 1. Brown (+ Voltage)<br>2. N/C<br>3. Blue (- Voltage)<br>4. N/C |  |  |

### Specifications

|                         |                                       |                             |                                       |
|-------------------------|---------------------------------------|-----------------------------|---------------------------------------|
| <b>Overmold:</b>        | TPU                                   | <b>Protection:</b>          | NEMA 1, 3, 4, 6P and IEC IP 67        |
| <b>Coupling Nut:</b>    | Nickel Plated CuZn or Stainless Steel | <b>Rated Voltage:</b>       | 300 V                                 |
| <b>Contact Carrier:</b> | TPU (Polyurethane)                    | <b>Rated Current:</b>       | 9 A                                   |
| <b>Contacts:</b>        | Gold Plated CuZn                      | <b>Ambient Temperature:</b> | -40 °C to +105 °C (-40 °F to +221 °F) |

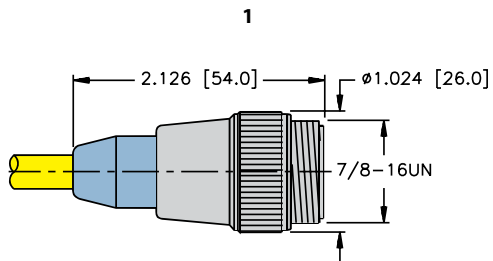

RSM ..

Page R8

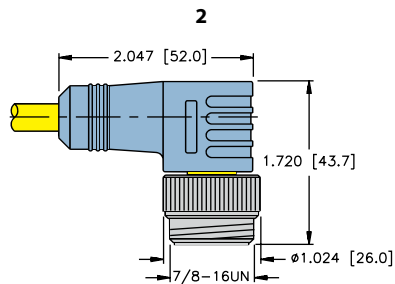

WSM ..

Page R8

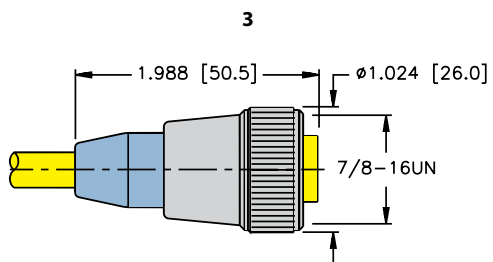

RKM ..

Page R8

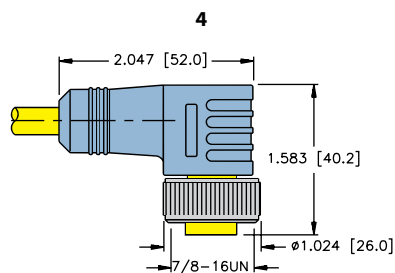

WKM ..

Page R8

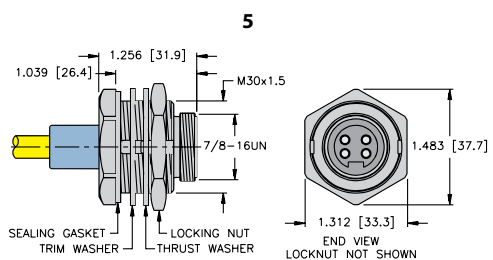

RSFP ..

Page R9

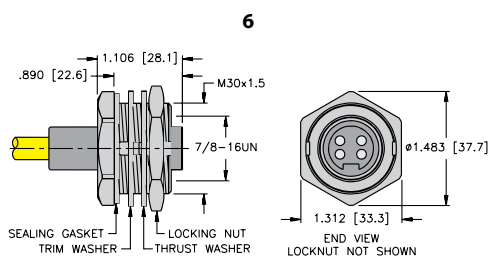

RKFP ..

Page R9

We reserve the right to make technical alterations without prior notice.



**Specifications**

**Overmold:** TPU  
**Coupling Nut:** Nickel Plated CuZn or Stainless Steel  
**Contact Carrier:** TPU or POM (Nylon)  
**Contacts:** Gold Plated CuZn

**Protection:** NEMA 1, 3, 4, 6P and IEC IP 68  
**Rated Voltage:** 250 V  
**Rated Current:** 4 A  
**Ambient Temperature:** -40 °C to +105 °C (-40 °F to +221 °F)

We reserve the right to make technical alterations without prior notice.

7

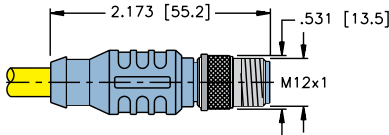

RSC ..

Page R8

8

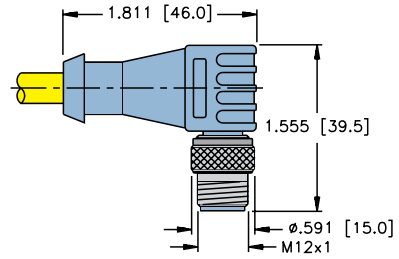

WSC ..

Page R8

9

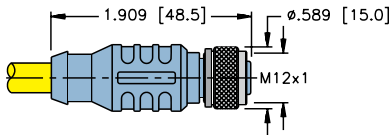

RKC ..

Page R8

10

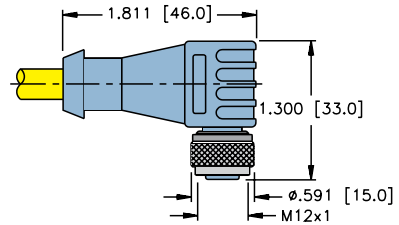

WKC ..

Page R8

11

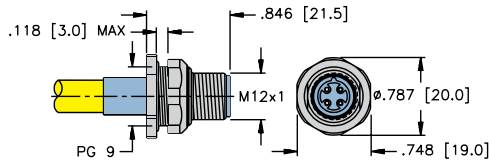

FSFD ..

Page R9

12

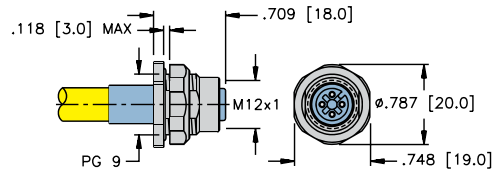

FKFD ..

Page R9

AS-interface® Media

# AS-interface® Physical Media Connectivity

## AS-interface, Tees

- Creates a Drop or Branch from the Main Bus Line
- Available in Minifast® or Eurofast® Bus or Drop Lines



| Housing Style | Part Number         | Features  | Wiring Diagrams |
|---------------|---------------------|---|-----------------|
|               | <b>RSV 2RKV 25</b>  | TPU (Polyurethane), stainless steel, 250 V, 4 A (Eurofast), 9 A (Minifast), -40 °C to +80 °C, Minifast drop connector           |                 |
|               | <b>RSCV 2RKC 25</b> | TPU (Polyurethane), stainless steel, 250 V, 4 A (Eurofast), -30 °C to +90 °C, Eurofast female drop connector                    |                 |
|               | <b>RKC 2RSC 25</b>  | TPU (Polyurethane), stainless steel, 250 V, 4 A (Eurofast), -30 °C to +90 °C, Eurofast male drop connector, nickel plated brass |                 |
|               | <b>RSCV WKCV 25</b> | TPU (Polyurethane), stainless steel, 250 V, 4 A (Eurofast), -40 °C to +105 °C, Eurofast male elbow                              |                 |
|               | <b>RSC RKC 25</b>   | TPU (Polyurethane), stainless steel, 250 V, 4 A (Eurofast), -40 °C to +105 °C, Eurofast male                                    |                 |

We reserve the right to make technical alterations without prior notice.

| Minifast |        | Pinouts   | Eurofast |        |
|----------|--------|---|----------|--------|
| Male     | Female |   | Male     | Female |
|          |        | 1. Brown (+ Voltage)<br>2. N/C<br>3. Blue (- Voltage)<br>4. N/C |          |        |

AS-interface, Gender Changers and Elbow Connectors

- Allows Quick and Easy Change from Male to Female Minifast® Connectors



| Housing Style | Part Number | Specs  | Application   | Wiring Diagrams |
|---------------|-------------|--|---|-----------------|
|               | RKM RKM 25  | TPU (Polyurethane)<br>250 V, 9 A<br>-40 °C to +80 °C | Minifast Female Gender Changer<br>• Male cordset to female receptacle |                 |

We reserve the right to make technical alterations without prior notice.

AS-interface® Media

| Minifast           | Pinouts   | Eurofast             |
|--------------------|---|----------------------|
| <p><b>Male</b></p> | <p>1. Brown (+ Voltage)<br/>2. N/C<br/>3. Blue (- Voltage)<br/>4. N/C</p> | <p><b>Female</b></p> |

# AS-interface® Physical Media Connectivity

## AS-interface, Eurofast® Flat Cable Adapter

- Allows the mixing of standard AS-I Flat Cable with Eurofast Round Cable in same system
- May be needed when going from a dry to a wet environment or an area where better sealing and Rugged Connectors are required

| Housing Style | Part Number            | Features   | Pinout            |
|---------------|------------------------|--|-------------------|
|               | <b>ASI-PM-1 BW1239</b> | TPU (Polyurethane)<br>250 V, 4 A<br>-40 °C to +75 °C | <b>Female</b><br> |

|  | Type                         | Approvals                      | Data Pair         |                             | Outer Jacket                | Bulk Cable Part Number / Weight/300 M |
|--|------------------------------|--------------------------------|-------------------|-----------------------------|-----------------------------|---------------------------------------|
|  |                              |                                | AWG Color Code    | DCR (/1000 feet) Insulation | Material Color Nominal O.D. |                                       |
|  | <b>2501</b><br>105 °C, 300 V | UL 2103<br>CSA AWM             | 2X16 AWG<br>BU/BN | 4.1 Ohms<br>TPE             | TPE, YELLOW,<br>Flat        | RB51822-*M,<br>42 lbs.                |
|  | <b>2511</b><br>105 °C, 300 V | UL 2103<br>CSA AWM             | 2X16 AWG<br>BU/BN | 4.1 Ohms<br>TPE             | TPE, BLACK,<br>Flat         | RB51821-*M,<br>42 lbs.                |
|  | <b>253G</b><br>75 °C, 300 V  | UL PLTC<br>CSA AWM II A/B, FT4 | 2X16 AWG<br>BU/BN | 4.1 Ohms<br>PO              | PVC, GRAY,<br>Flat          | RB51240-*M,<br>42 lbs.                |
|  | <b>253BK</b><br>75 °C, 300 V | UL PLTC<br>CSA AWM II A/B, FT4 | 2X16 AWG<br>BU/BN | 4.3 Ohms<br>PO              | PVC, BLACK,<br>Flat         | RB51241-*M,<br>42 lbs.                |
|  | <b>253Y</b><br>75 °C, 300 V  | UL PLTC<br>CSA AWM II A/B, FT4 | 2X16 AWG<br>BU/BN | 4.3 Ohms<br>PO              | PVC, YELLOW,<br>Flat        | RB51242-*M,<br>42 lbs.                |

\* Indicates length in meters.  
Standard spool lengths are 30, 75, 100, 150, 200, 225, 300 meters. Consult factory for other lengths.

We reserve the right to make technical alterations without prior notice.

AS-interface, Minifast® Male Receptacles

- Provides Quick Connection to Field Devices or Enclosures
- Available for 1/2-14 NPT, 1/2-14 NPSM, 3/4-14 NPT and M20 Threads
- (7/8-16 UN) Minifast Connection



We reserve the right to make technical alterations without prior notice.

| Housing Style                 | Female Part Number     | Male Part Number       | Features   | Pinout   |
|-------------------------------|------------------------|------------------------|--|--|
| <p><b>RKF 25.../14.5</b></p>  | <b>RKF 25-*M/14.5</b>  | <b>RSF 25-*M/14.5</b>  | Nickel plated CuZn or stainless steel<br>300 V, 9 A, -40 °C to +105 °C, 1/2-14 NPT full length threads | <p style="text-align: center;"><b>Female</b></p>   |
| <p><b>RSF 25.../14.5</b></p>  |                        |                        |  |  |
| <p><b>RKF 25.../14.75</b></p> | <b>RKF 25-*M/14.75</b> | <b>RSF 25-*M/14.75</b> | Nickel plated CuZn or stainless steel<br>300 V, 9 A, -40 °C to +105 °C, 3/4-14 NPT full length threads | <ol style="list-style-type: none"> <li>1. BN</li> <li>2. N/C</li> <li>3. BU</li> <li>4. N/C</li> </ol> |
| <p><b>RSF 25.../14.75</b></p> |                        |                        |  |  |
| <p><b>RKF 25.../M20</b></p>   | <b>RKF 25-*M/M20</b>   | <b>RSF 25-*M/M20</b>   | Nickel plated CuZn or stainless steel<br>300 V, 9 A, -40 °C to +105 °C, M20x1.5 threads                | <p style="text-align: center;"><b>Male</b></p>   |
| <p><b>RSF 25.../M20</b></p>   |                        |                        |  |  |

Standard cable length is 0.5 meters. Consult factory for other lengths.  
 Standard housing material is nickel plated brass. "RKF .."; "RKFV .." indicates 316 stainless steel housing.  
 For locknuts to be included, add "W/LN" to the end of the part number.

AS-interface® Media

# AS-interface® Physical Media Connectivity

## AS-interface, Minifast® Male Receptacles

- Provides Quick Connection to Field Devices or Enclosures
- Available for 1/2-14 NPT, 1/2-14 NPSM, 3/4-14 NPT and M20 Threads
- (7/8-16 UN) Minifast Connection



| Housing Style        | Female Part Number | Male Part Number | Features  | Pinout               |
|----------------------|--------------------|------------------|---|----------------------|
| <p><b>RKF ..</b></p> | <b>RKF 25-*M</b>   | <b>RSF 25-*M</b> | Nickel plated CuZn or stainless steel 300 V, 9 A -40 °C to +105 °C, 1/2-14 NPSM threads | <p><b>Female</b></p> |
| <p><b>RSF ..</b></p> |                    |                  |   | <p><b>Male</b></p>   |

Standard cable length is 0.5 meters. Consult factory for other lengths.  
 Standard housing material is nickel plated brass. "RKF .."; "RKFV .." indicates 316 stainless steel housing.  
 For locknuts to be included, add "W/LN" to the end of the part number.

We reserve the right to make technical alterations without prior notice.

AS-interface, Eurofast® Male Receptacles

- Mounted for Quick Connection to Enclosures
- (M12x1) Eurofast Connectors



We reserve the right to make technical alterations without prior notice.

| Housing Style               | Female Part Number    | Male Part Number      | Features   | Pinout   |
|-----------------------------|-----------------------|-----------------------|--|--|
| <p><b>FK 25...14.5</b></p>  | <b>FK 25-*M/14.5</b>  | <b>FS 25-*M/14.5</b>  | Nickel plated CuZn or stainless steel, 250 V, 4 A, -40 °C to +105 °C, 1/2-14 NPT full length threads |  |
| <p><b>FS 25...14.5</b></p>  |                       |                       |  |  |
| <p><b>FK 25...14.75</b></p> | <b>FK 25-*M/14.75</b> | <b>FS 25-*M/14.75</b> | Nickel plated CuZn or stainless steel, 250 V, 4 A, -40 °C to +105 °C, 3/4-14 NPT full length threads | <ol style="list-style-type: none"> <li>1. BN</li> <li>2. N/C</li> <li>3. BU</li> <li>4. N/C</li> </ol> |
| <p><b>FS 25...14.75</b></p> |                       |                       |  |  |
| <p><b>FK 25.../M20</b></p>  | <b>FK 25-*M/M20</b>   | <b>FS 25-*M/M20</b>   | Nickel plated CuZn or stainless steel, 250 V, 4 A, -40 °C to +105 °C, M20x1.5 threads                |  |
| <p><b>FS 25.../M20</b></p>  |                       |                       |  |  |

Standard cable length is 0.5 meters. Consult factory for other lengths.  
 Standard housing material is nickel plated brass. "RKF .."; "RKFV .." indicates 316 stainless steel housing.

AS-interface® Media

# AS-interface® Physical Media Connectivity

## AS-interface, Eurofast® Male Receptacles

- Mounted for Quick Connection to Enclosures
- (M12x1) Eurofast Connectors



| Housing Style                                 | Female Part Number | Male Part Number | Features   | Pinout                                  |
|---|--------------------|------------------|--|---|
| <p><b>FK 25...</b></p> <p><b>FS 25...</b></p> | <b>FK 25-*M</b>    | <b>FS 25-*M</b>  | Nickel plated CuZn or stainless steel, 250 V, 4 A, -40 °C to +105 °C, PG 9 threads | <p><b>Female</b></p> <p><b>Male</b></p> |

Standard cable length is 0.5 meters. Consult factory for other lengths.  
 Standard housing material is nickel plated brass. "RKF .."; "RKFV .." indicates 316 stainless steel housing.

We reserve the right to make technical alterations without prior notice.



## AS-interface, Minifast® Field Wireable Connectors with Labels

- Allows for Quick Connection when Pre-Molded Cables are not available
- Available for Male and Female Connectors
- Color Coded Wire Connection for AS-interface



| Housing Style                                 | Female Part Number      | Male Part Number        | Features   | Pinout               |
|---|-------------------------|-------------------------|--|----------------------|
| <p><b>BK 41..</b></p> <p><b>BS 41..</b></p>   | <b>BK 4140-0/9/ASI</b>  | <b>BS 4140-0/9/ASI</b>  | Glass filled nylon, PG 9 cable gland, accepts 6-8 mm cable diameter, screw terminals, 90 °C, 250 V, 9 A, mates with standard, 4-pin cordsets and receptacles | <p><b>Female</b></p> |
| <p><b>BKV 41..</b></p> <p><b>BSV 41..</b></p> | <b>BKV 4140-0/9/ASI</b> | <b>BSV 4140-0/9/ASI</b> |  |                      |

We reserve the right to make technical alterations without prior notice.

AS-interface® Media

# AS-interface® Physical Media Connectivity

## AS-interface, Eurofast® Field Wireable Connectors with Labels

- Allows for Quick Connection when Pre-Molded Cables are not available
- Available for Male and Female Connectors
- Color Coded Wire Connection for AS-interface



| Housing Style                              | Female Part Number      | Male Part Number         | Features   | Pinout               |
|--|-------------------------|--------------------------|--|----------------------|
| <p><b>B 81..</b></p> <p><b>BS 81..</b></p> | <b>B 8141-0/PG9/ASI</b> | <b>BS 8141-0/PG9/ASI</b> | PBT, black, PG 9 cable gland, accepts 6-8 mm cable diameter, screw terminals, 85 °C, 250 V, 4 A, mates with standard, 4-pin cordsets and receptacles | <p><b>Female</b></p> |
| <p><b>B 82..</b></p> <p><b>BS 82..</b></p> | <b>B 8241-0/PG9/ASI</b> | <b>BS 8241-0/PG9/ASI</b> |  | <p><b>Male</b></p>   |

We reserve the right to make technical alterations without prior notice.

**AS-interface, Gender Changer**

- Allows quick and easy change from Male to Female and (7/8-16 UN) Minifast® to (M12x1) Eurofast® Connectors



| Housing Style | Part Number          | Features  | Wiring Diagrams |
|---------------|----------------------|---|-----------------|
|               | <b>RSM 25-FK 4.5</b> | Nickel plated CuZn or stainless steel, 250 V, 4 A, 40 °C to +75 °C, female Eurofast, male Minifast, 4-pin |                 |

We reserve the right to make technical alterations without prior notice.

AS-interface® Media

**Pinouts**

| Minifast | Eurofast |
|----------|----------|
| Male     | Female   |
|          |          |

# AS-interface® Physical Media Connectivity

## FOUNDATION™ fieldbus, Conduit Adapters

- Converts Standard Conduits to Quick Disconnect
- Fiberglass Reinforced Nylon Housings
- Nickel Plated Brass Connectors available
- 3/4" Form 8 or Mark 9
- 1" Form 7 available upon request
- Gasket and Mounting Screws provided
- IP67



| Housing Style | 1 Port Part Number   | 2 Port Part Number   | Specifications   | Pinout            |
|---------------|----------------------|----------------------|--|-------------------|
|               | <b>BCA-49-E123</b>   | <b>BCA-49-E223</b>   | 3/4" Form 8 or Mark 9, M12 x 1 stainless steel connectors                              | <b>Female</b><br> |
|               | <b>BCA-49-M123</b>   | <b>BCA-49-M223</b>   | 3/4" Form 8 or Mark 9, 7/8"-16 UN stainless steel connectors                           | <b>Female</b><br> |
|               | <b>BCA-49SC-M123</b> | <b>BCA-49SC-M223</b> | Short circuit protection, 3/4" Form 8 or Mark 9, 7/8"-16 UN stainless steel connectors |                   |

We reserve the right to make technical alterations without prior notice.

|                          |            |
|--------------------------|------------|
| <b>Part Number Keys</b>  | <b>S2</b>  |
| <b>M12 (eurofast®)</b>   | <b>S4</b>  |
| <b>M8 (picofast®)</b>    | <b>S44</b> |
| <b>7/8" (minifast®)</b>  | <b>S54</b> |
| <b>1/2" (microfast®)</b> | <b>S68</b> |
| <b>Accessories</b>       | <b>S72</b> |

### Features

- Products for M12 Eurofast, M8 Picofast, 7/8" Minifast and 1/2 Microfast
- Consolidate up to 16 I/O signals
- AC or DC options
- PNP LED, NPN LED and non-LED offerings
- Multiple housing styles and materials

multibox®

# Junction Box Connectivity Products

## M12 Eurofast® Standard and Low Profile Junction Box Part Number Keys

Part Number Keys are to assist in IDENTIFICATION ONLY. Consult factory for catalog items not identified.

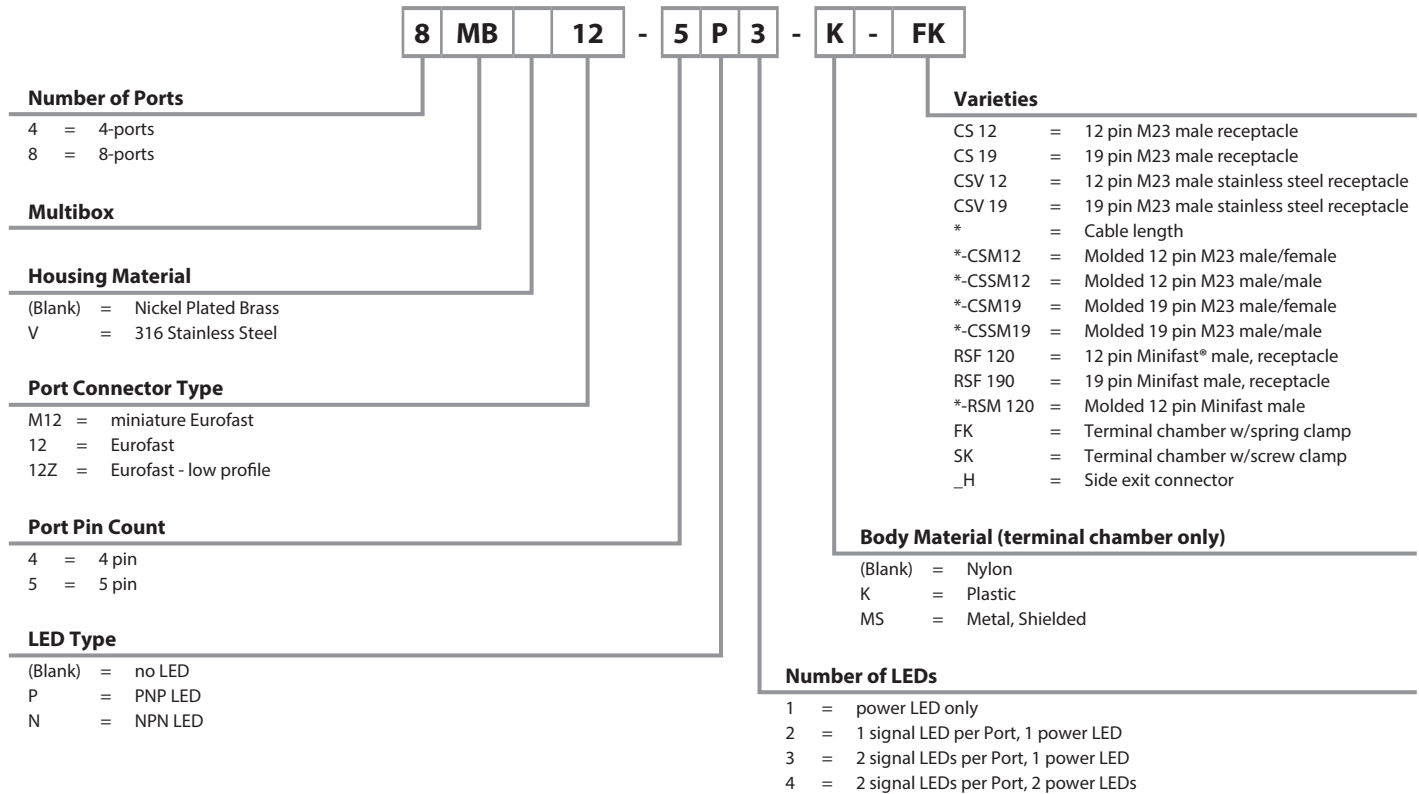
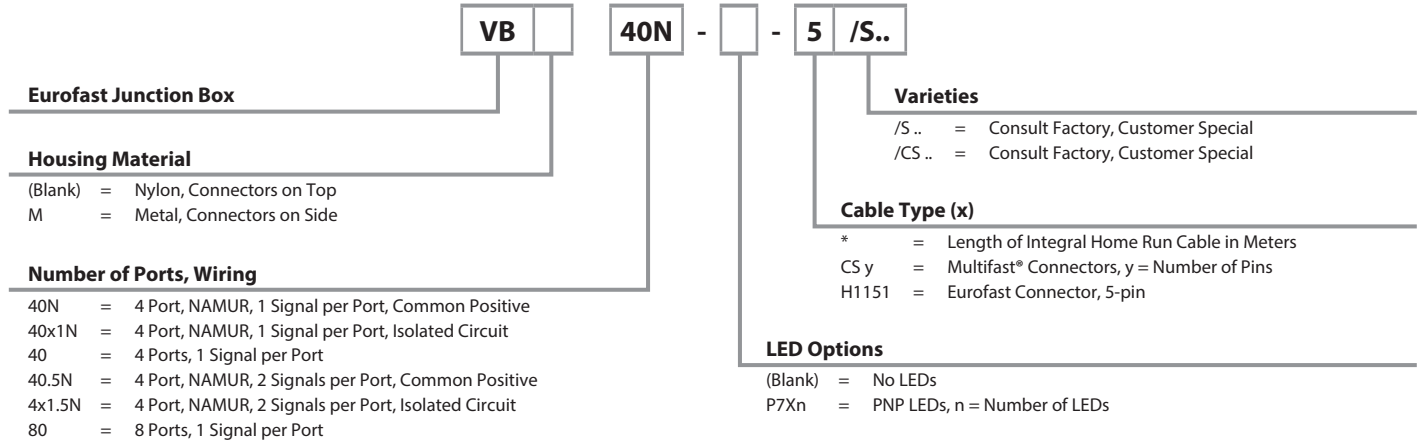

## M8 Picofast® Junction Box Part Number Key

Part Number Keys are to assist in IDENTIFICATION ONLY. Consult factory for catalog items not identified.



### Picofast Junction Box

#### Number of Ports

- 403 = 4-Port, 1 signal per Port
- 404 = 4-Port, 2 signals per Port
- 803 = 8-Port, 1 signal per Port
- 804 = 8-Port, 2 signals per Port
- 1003 = 10-Port, 1 signal per Port

#### Number of Ports, Wiring

- (Blank) = No Locking Sleeve
- Z = Locking Sleeve (Snap lock)
- M = M8x1 Threaded Coupling Nut

### Varieties

- \*C = Length of Integral Home Run Cable in Meters
- BS14 = M16 Threads, 14-pins
- BS19 = M16 Threads, 19-pins
- BS1614 = M16 Threads

### LED Options

- (Blank) = No LEDs
- PXn = PNP LEDs, n = Number of LEDs

## 7/8-16 UN Minifast® Junction Box Part Number Key



### Number of Ports

- 4
- 6
- 8
- Overmolded Junction Boxes
- 6
- 7

### Type of Connector / Threads

- RKF = Minifast, Female Contact Holder, Female Threads
- RXF = Minifast, Female Contact Holder, Male Threads
- MBMA = Minifast overmolded junction box

### Number of Ports, Wiring

- 30 = 3-pin, Standard Wiring
- 301 = 3-pin, Series Wiring
- 40 = 4-pin, Standard Wiring
- Overmolded Junction Boxes
- 3 = 250 VAC/300 VDC
- 3A2 = 40-120 VDC, LEDs for power and signal

### Varieties

- /S.. = Consult Factory, Customer Special
- /CS.. = Consult Factory, Customer Special

### Cable Type (x)

- \*M = Length of Integral Home Run Cable in Meters
- CS12 = Multifast® Connector, 12-pin (only overmolded option)
- B1131 = Minifast Connector, 3-pin
- B1161 = Minifast Connector, 6-pin
- RSF60 = Minifast Connector, 6-pin
- RSF70 = Minifast Connector, 7-pin
- RSF80 = Minifast Connector, 8-pin
- RSF100 = Minifast Connector, 10-pin
- RSF120 = Minifast Connector, 12-pin

### LED Options

- (Blank) = No LEDs
- Xn = LEDs, n = Number of LEDs

## 1/2" Microfast® Junction Box Part Number Key



### Microfast Junction Box

### Number of Ports, Wiring Type

- 40 = 4 Port, 1 Signal per Port
- 60 = 6 Port, 1 Signal per Port
- 80 = 8 Port, 1 Signal per Port

### Varieties

- /S.. = Consult Factory, Customer Special
- /CS.. = Consult Factory, Customer Special

### Cable Type (x)

- (Number) = Length of Integral Home Run Cable in Meters
- CS12 = Multifast Connector, 12-pins
- B1161 = Minifast Connector, 6-pins

### LED Options

- (Blank) = No LEDs
- Xn = LEDs, n = Number of LEDs

# Junction Box Connectivity Products

## Multibox® Eurofast® Miniature Junction Boxes, 4-Port

- Single/Dual Input/Output per Port
- Available with or without LEDs
- Rugged Plastic Housing
- M12 or M16 Quick Disconnect or Integral Cable



### 4-Port, 1 Signal per Port, 10-48 VDC

| Application  | Specifications   | Pinout          |              |                 |              | No LEDs       | PNP LED         | NPN LED         |
|--|--|-----------------|--------------|-----------------|--------------|---------------|-----------------|-----------------|
| 4-port J-box<br>1 signal per port<br>Integral cable                    | 4 A/port<br>2 A total w/1 power pair   | <u>Function</u> | <u>Color</u> | <u>Function</u> | <u>Color</u> | 4MBM12-4-*C   | 4MBM12-4P2-*C   | 4MBM12-4N2-*C   |
|  |  | +V              | BN           | Port 1/4        | WH           |               |                 |                 |
| 4-port J-box<br>1 signal per port<br>stainless steel<br>Integral cable | 4 A total w/dual power<br>Yellow PVC 8/24 AWG  | -V              | BU           | Port 2/4        | GN           | 4MBMV12-4-*C  | 4MBMV12-4P2-*C  | 4MBMV12-4N2-*C  |
|  |  | +V              | PK           | Port 3/4        | YE           |               |                 |                 |
| 4-port J-box<br>1 signal per port<br>Eurofast (M12)<br>connector       | 4 A/port<br>2 A total w/1 power pair<br>4 A total w/dual power<br>8-pin Eurofast connector<br>8 conductors. Mates<br>with RKC 8.8T | -V              | RD           | Port 4/4        | GY           | 4MBM12-4-FS 8 | 4MBM12-4P2-FS 8 | 4MBM12-4N2-FS 8 |
|  |  | +V              | 6            | Port 3/4        | 3            |               |                 |                 |
|  |  | -V              | 8            | Port 4/4        | 4            |               |                 |                 |

### 4-Port, 2 Signals per Port, 10-48 VDC

| Application   | Specifications  | Pinout          |                  |                 |                  | No LEDs       | PNP LED         | NPN LED         |
|---|---|-----------------|------------------|-----------------|------------------|---------------|-----------------|-----------------|
| 4-port J-box<br>2 signals per port<br>Integral cable                    | 4 A/port<br>3 A total w/1 power pair  | <u>Function</u> | <u>Color</u>     | <u>Function</u> | <u>Color</u>     | 4MBM12-5-*C   | 4MBM12-5P3-*C   | 4MBM12-5N3-*C   |
|   |   | +V              | BN               | Port 2/4        | GN               |               |                 |                 |
| 4-port J-box<br>2 signals per port<br>stainless steel<br>Integral cable | 6 A total w/dual power<br>Yellow PVC 12/24 AWG  | -V              | BU               | Port 2/2        | RD               | 4MBMV12-5-*C  | 4MBMV12-5P3-*C  | 4MBMV12-5N3-*C  |
|   |   | +V              | RD/BU            | Port 3/4        | YE               |               |                 |                 |
| 4-port J-box<br>2 signals per port<br>Versafast™ (M16)<br>connector     | 4 A/port<br>3 A total w/1 power pair<br>6 A total w/dual power<br>14-pin Versafast<br>connector 12 conductors.<br>Mates with BKM 14-917-* | -V              | GY/PK            | Port 3/2        | BK               | 4MBM12-5-BS14 | 4MBM12-5P3-BS14 | 4MBM12-5N3-BS14 |
|   |   | Port 1/4        | WH               | Port 4/4        | GY               |               |                 |                 |
|   |   | Port 1/2        | PK               | Port 4/2        | VT               |               |                 |                 |
|   |   | <u>Function</u> | <u>Pin/Color</u> | <u>Function</u> | <u>Pin/Color</u> |               |                 |                 |
|   |   | +V              | A/RD/BU          | Port 2/4        | E/GN             |               |                 |                 |
|   |   | -V              | L/GY/PK          | Port 2/2        | R/RD             |               |                 |                 |
|   |   | +V              | M/BN             | Port 3/4        | O/YE             |               |                 |                 |
|   |   | -V              | U/BU             | Port 3/2        | G/BK             |               |                 |                 |
|   |   | Port 1/4        | P/WH             | Port 4/4        | C/GY             |               |                 |                 |
|   |   | Port 1/2        | N/PK             | Port 4/2        | S/VT             |               |                 |                 |

We reserve the right to make technical alterations without prior notice.

### Functional Wiring Diagrams

(No LED Version)  
1 Signal per Port

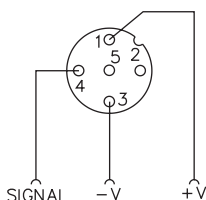

(PNP LED Version)  
1 Signal per Port

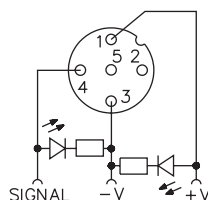

(No LED Version)  
2 Signals per Port

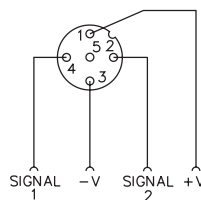

(PNP LED Version)  
2 Signals per Port

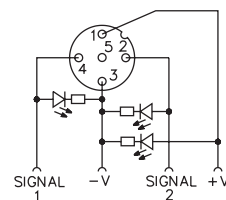



### Specifications

|                              |  |                      |   |
|------------------------------|--|----------------------|---|
| <b>Housing:</b>              | Nylon                                  | <b>Temperature:</b>  | -30 °C to +80 °C (-22 °F to +176 °F)  |
| <b>Connectors:</b>           | TPU (M12), PETP (M16)                  | <b>Protection:</b>   | IEC IP67  |
| <b>Contacts:</b>             | Gold plated brass.                     | <b>Accessories:</b>  | KS 5/10 labels  |
| <b>Thread Inserts:</b>       | Nickel plated brass or stainless steel | <b>Cable Length:</b> | Standard length is nominal 5 meters. Other lengths available by request - Consult factory |
| <b>Cable:</b>                | See table                              |                      |   |
| <b>Recommended Splitter:</b> | YB2-FSM 4.5/2FKM 4.5                   |                      |   |

### Dimensions

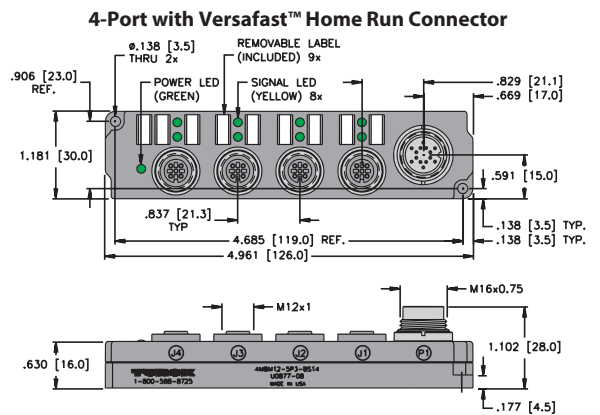
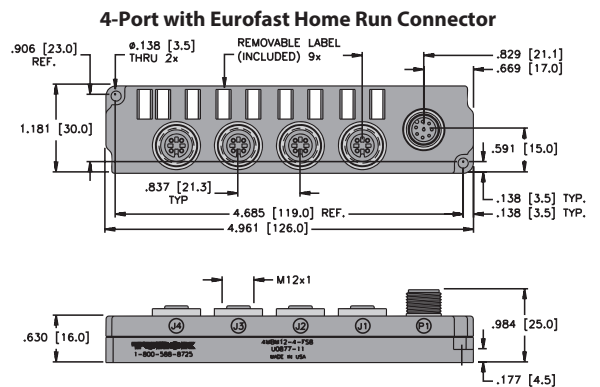
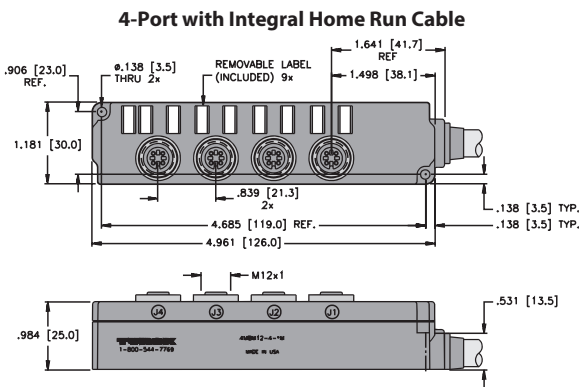

We reserve the right to make technical alterations without prior notice.

multibox®, eurofast®

### Pinout

| 4-Pin Eurofast | 5-Pin Eurofast | 8-Pin Eurofast | 14-Pin Versafast |
|----------------|----------------|----------------|------------------|
| Female         | Female         | Male           | Male             |
|                |                |                |                  |

# Junction Box Connectivity Products

## Multibox® Eurofast® Low Profile Junction Boxes, 4-Port

- Single Input/Output per Port
- Rugged Plastic Housing
- Available with or without LEDs
- M23 Quick Disconnect or Integral Home Run Cable
- Threaded M12 Connection



| Application  | Specifications  | Pinout                                |  | No LEDs   | PNP LED  | NPN LED        |                  |                  |
|--|---|---------------------------------------|--|---|--|----------------|------------------|------------------|
| 4-port J-box<br>1 signal per port,<br>Integral cable                   | 2 A/signal, 9 A total<br>Yellow PVC cable<br>7/18 AWG foil shield<br>and 20 AWG drain             | <u>Function</u><br>+V<br>-V<br>Ground | <u>Color</u><br>BN<br>BU<br>GN / YE                | <u>Function</u><br>Port 1<br>Port 2<br>Port 3<br>Port 4 | <u>Color</u><br>WH<br>GN<br>YE<br>GY                       | 4MB12Z-4-*     | 4MB12Z-4P2-*     | 4MB12Z-4N2-*     |
| 4-port J-box<br>1 signal per port,<br>Multifast® front<br>connector    | 2 A/signal, 9 A total<br>12-pin Multifast<br>connector 7<br>conductors. Mates<br>with CKCM 12-7-* | <u>Function</u><br>+V<br>-V<br>Ground | <u>Pin / Color</u><br>11/BN<br>10/BU<br>12 / GN/YE | <u>Function</u><br>Port 1<br>Port 2<br>Port 3<br>Port 4 | <u>Pin / Color</u><br>1 / WH<br>2 / GN<br>3 / YE<br>4 / GY | 4MB12Z-4-CS12  | 4MB12Z-4P2-CS12  | 4MB12Z-4N2-CS12  |
| 4-port J-box<br>1 signal per port,<br>Multifast side<br>exit connector | 2 A/signal, 9 A total<br>12-pin Multifast<br>connector 7<br>conductors. Mates<br>with CKCM 12-7-* | <u>Function</u><br>+V<br>-V<br>Ground | <u>Pin / Color</u><br>11/BN<br>10/BU<br>12 / GN/YE | <u>Function</u><br>Port 1<br>Port 2<br>Port 3<br>Port 4 | <u>Pin / Color</u><br>1 / WH<br>2 / GN<br>3 / YE<br>4 / GY | 4MB12Z-4-CS12H | 4MB12Z-4P2-CS12H | 4MB12Z-4N2-CS12H |

\* Cable length in meters.

We reserve the right to make technical alterations without prior notice.

### Functional Wiring Diagrams

(PNP LED Version)  
1 Signal per Port

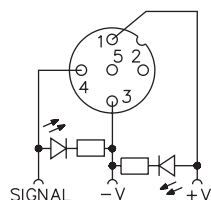

(No LED Version)  
1 Signal per Port

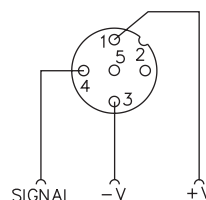

## Multibox® Eurofast® Low Profile Junction Boxes, 4-Port

### Specifications

|                        |                        |                      |   |
|------------------------|------------------------|----------------------|---|
| <b>Housing:</b>        | Nylon                  | <b>Temperature:</b>  | -40 °C to +85 °C (-40 °F to +185 °F)  |
| <b>Connectors:</b>     | Eurofast: Nylon or TPU | <b>Protection:</b>   | IEC IP68, IP69K   |
| <b>Contacts:</b>       | Gold plated brass      | <b>Accessories:</b>  | (2) VZ 3 closure caps and a VZ 12 label kit (5 labels) included                           |
| <b>Thread Inserts:</b> | Nickel plated brass    | <b>Cable Length:</b> | Standard length is nominal 5 meters. Other lengths available by request - Consult factory |
| <b>Cable:</b>          | See table              |                      |   |

### Dimensions

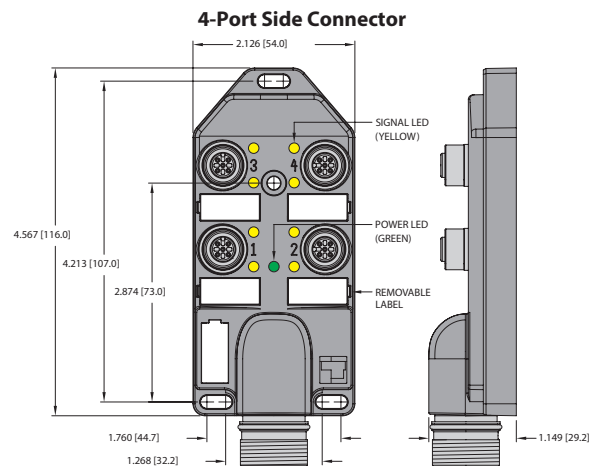
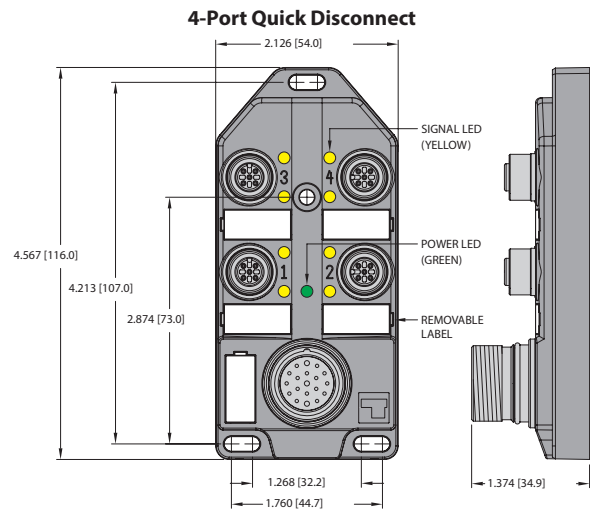
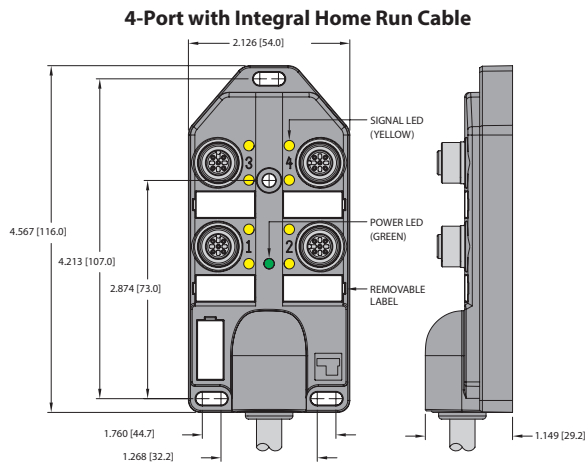

We reserve the right to make technical alterations without prior notice.

multibox®, eurofast®

### Pinout

| 5-Pin Eurofast | 12-Pin Multifast® |
|----------------|-------------------|
| Female         | Male              |
|                |                   |

# Junction Box Connectivity Products

## Multibox® Eurofast® Low Profile Junction Boxes, 4-Port

- Single Input/Output per Port
- Rugged Plastic Housing
- Available with or without LEDs
- Minifast® Quick Disconnect or Integral Home Run Cable with Minifast Connector
- Threaded M12 Connection



### 4-Port, 1 Signal per Port, 10-30 VDC

| Application   | Specifications   | Pinout          |                    |                 |                    | No LEDs               | PNP LED                 | NPN LED                 |
|---|--|-----------------|--------------------|-----------------|--------------------|-----------------------|-------------------------|-------------------------|
| 4-port J-box<br>1 signal per port,<br>integral cable with<br>Minifast connector | 2 A/signal<br>7 A total<br>12-pin Minifast<br>connector<br>7 conductors.<br>Mates with<br>RKM 126-*M | <u>Function</u> | <u>Pin / Color</u> | <u>Function</u> | <u>Pin / Color</u> | 4MB12Z-4-*-RSM<br>120 | 4MB12Z-4P2-*-RSM<br>120 | 4MB12Z-4N2-*-RSM<br>120 |
|   |  | +V              | 10 / RD            | Port 1          | 1 / OG             |                       |                         |                         |
| 4-port J-box<br>1 signal per port,<br>Minifast connector                        | 2 A/signal<br>7 A total<br>12-pin Minifast<br>connector<br>7 conductors.<br>Mates with<br>RKM 126-*M | -V              | 11 / WH            | Port 2          | 2 / BU             | 4MB12Z-4-RSF120       | 4MB12Z-4P2-RSF120       | -----                   |
|   |  | Ground          | 9 / GN             | Port 3          | 3 / WH/BK          |                       |                         |                         |
|   |  |                 |                    | Port 4          | 4 / RD/BK          |                       |                         |                         |

\* Cable length in meters.

We reserve the right to make technical alterations without prior notice.

### Functional Wiring Diagrams

(PNP LED Version)  
1 Signal per Port

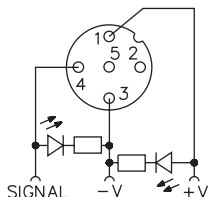

(No LED Version)  
1 Signal per Port

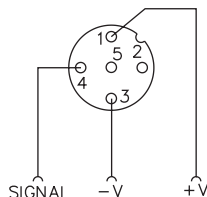

## Multibox® Eurofast® Low Profile Junction Boxes, 4-Port

### Specifications

|                        |                        |                      |   |
|------------------------|------------------------|----------------------|---|
| <b>Housing:</b>        | Nylon                  | <b>Temperature:</b>  | -40 °C to +85 °C (-40 °F to +185 °F)  |
| <b>Connectors:</b>     | Eurofast: Nylon or TPU | <b>Protection:</b>   | IEC IP68, IP69K   |
| <b>Contacts:</b>       | Gold plated brass      | <b>Accessories:</b>  | (2) VZ 3 closure caps and a VZ 12 label kit (5 labels) included                           |
| <b>Thread Inserts:</b> | Nickel plated brass    | <b>Cable Length:</b> | Standard length is nominal 5 meters. Other lengths available by request - Consult factory |
| <b>Cable:</b>          | See table              |                      |   |

### Dimensions

4-Port, Integral Home Run with Minifast® Connector

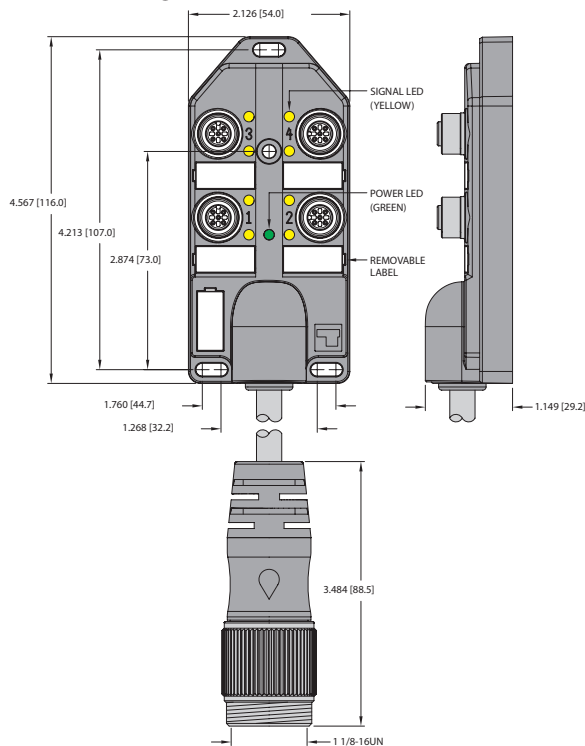

4-Port, Minifast Quick Disconnect

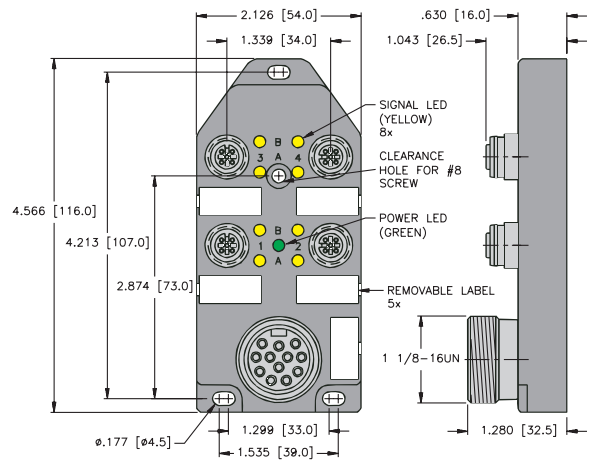

We reserve the right to make technical alterations without prior notice.

multibox®, eurofast®

### Pinout

| 5-Pin Eurofast | 12-Pin Minifast |
|----------------|-----------------|
| Female         | Male            |
|                |                 |

# Junction Box Connectivity Products

## Multibox® Eurofast® Low Profile Junction Boxes, 4-Port

- Dual Input/Output per Port
- Rugged Plastic Housing
- Available with or without LEDs
- M23 Quick Disconnect or Integral Home Run Cable
- Threaded M12 Connection



### 4-Port, 2 Signals per Port, 10-30 VDC

| Application  | Specifications  | Pinout  |   |   |   | No LEDs        | PNP LED          | NPN LED          |
|--|---|---|---|---|---|----------------|------------------|------------------|
| 4-port J-box<br>2 signals per port<br>Integral cable                 | 2 A/signal<br>9 A total<br>Yellow PVC cable<br>3/18 AWG,<br>8/22 AWG<br>foil shield and<br>20 AWG drain | <u>Function</u><br>+V<br>-V<br>Ground<br>Port 1, Sig 1<br>Port 1, Sig 2 | <u>Color</u><br>BN<br>BU<br>GN / YE<br>WH<br>GY / PK                        | <u>Function</u><br>Port 2, Sig 1<br>Port 2, Sig 2<br>Port 3, Sig 1<br>Port 3, Sig 2<br>Port 4, Sig 1<br>Port 4, Sig 2 | <u>Color</u><br>GN<br>RD / BU<br>YE<br>WH / GN<br>GY<br>BN / GN                           | 4MB12Z-5-*     | 4MB12Z-5P3-*     | 4MB12Z-5N3-*     |
| 4-port J-box<br>2 signals per port<br>Multifast® connector           | 2 A/signal<br>9 A total<br>19-pin Multifast connector<br>11 conductors.<br>Mates with CKM 19-11-*       | <u>Function</u><br>+V<br>-V<br>Ground<br>Port 1, Sig 1<br>Port 1, Sig 2 | <u>Color</u><br>19 / BN<br>6 / BU<br>12 / GN / YE<br>15 / WH<br>7 / GY / PK | <u>Function</u><br>Port 2, Sig 1<br>Port 2, Sig 2<br>Port 3, Sig 1<br>Port 3, Sig 2<br>Port 4, Sig 1<br>Port 4, Sig 2 | <u>Color</u><br>5 / GN<br>4 / RD / BU<br>16 / YE<br>8 / WH / GN<br>3 / GY<br>14 / BN / GN | 4MB12Z-5-CS19  | 4MB12Z-5P3-CS19  | 4MB12Z-5N3-CS19  |
| 4-port J-box<br>2 signals per port<br>Multifast, side exit connector | 2 A/signal<br>9 A total<br>19-pin Multifast connector<br>11 conductors.<br>Mates with CKM 19-11-*       | <u>Function</u><br>+V<br>-V<br>Ground<br>Port 1, Sig 1<br>Port 1, Sig 2 | <u>Color</u><br>19 / Bn<br>6 / Bu<br>12 / GN / YE<br>15 / WH<br>7 / Gy / Pk | <u>Function</u><br>Port 2, Sig 1<br>Port 2, Sig 2<br>Port 3, Sig 1<br>Port 3, Sig 2<br>Port 4, Sig 1<br>Port 4, Sig 2 | <u>Color</u><br>5 / GN<br>4 / Rd / Bu<br>16 / YE<br>8 / WH / GN<br>3 / Gy<br>14 / Bn / Gn | 4MB12Z-5-CS19H | 4MB12Z-5P3-CS19H | 4MB12Z-5N3-CS19H |

We reserve the right to make technical alterations without prior notice.

### Functional Wiring Diagrams

(PNP LED Version)  
2 Signals per Port

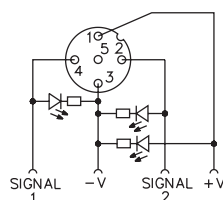

(No LED Version)  
2 Signals per Port

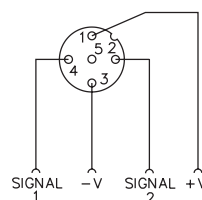

## Multibox® Eurofast® Low Profile Junction Boxes, 4-Port

### Specifications

|                              |                        |                      |   |
|------------------------------|------------------------|----------------------|---|
| <b>Housing:</b>              | Nylon                  | <b>Temperature:</b>  | -40 °C to +85 °C (-40 °F to +185 °F)  |
| <b>Connectors:</b>           | Eurofast: Nylon or TPU | <b>Protection:</b>   | IEC IP68, IP69K   |
| <b>Contacts:</b>             | Gold plated brass      | <b>Accessories:</b>  | (2) VZ 3 closure caps and a VZ 12 label kit (5 labels) included                           |
| <b>Thread Inserts:</b>       | Nickel plated brass    | <b>Cable Length:</b> | Standard length is nominal 5 meters. Other lengths available by request - Consult factory |
| <b>Cable:</b>                | See table              |                      |   |
| <b>Recommended Splitter:</b> | YB2-FSM 4.5-2 FKM 4.5  |                      |   |

### Dimensions

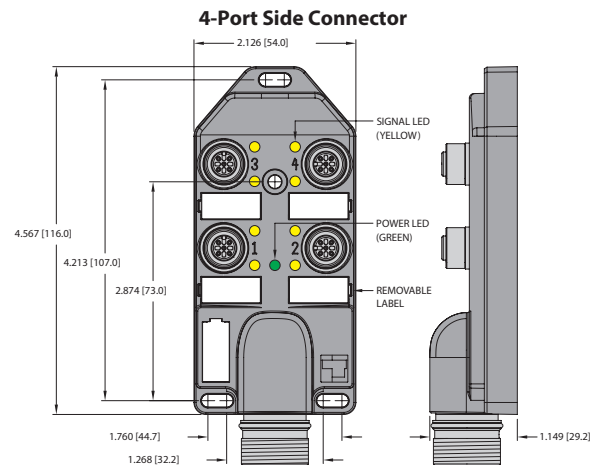
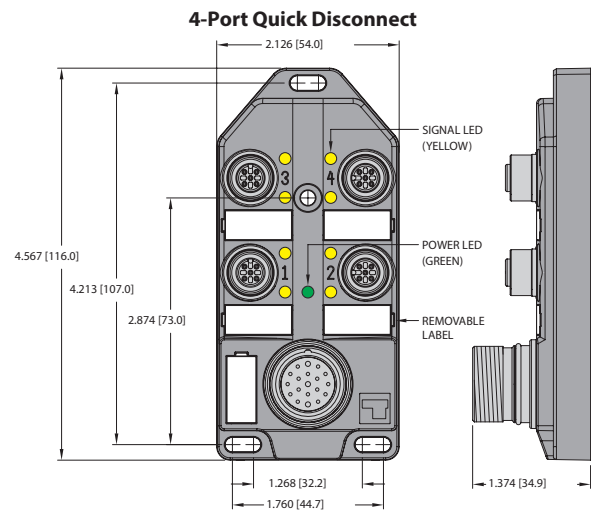
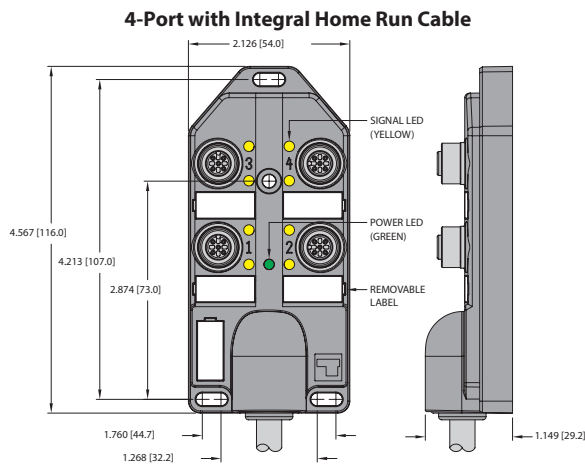

### Pinout

| 5-Pin Eurofast | 19-Pin Multifast® |
|----------------|-------------------|
| Female         | Male              |
|                |                   |

We reserve the right to make technical alterations without prior notice.

multibox®, eurofast®

# Junction Box Connectivity Products

## Multibox® Eurofast® Low Profile Junction Boxes, 6-Port

- Single Input/ Output per Port
- Rugged Plastic Housing
- Available with or without LEDs
- M23 Quick Disconnect or Integral Home Run Cable
- Threaded M12 Connection



### 6-Port, 1 Signal per Port, 10-30 VDC

| Application  | Specifications   | Pinout          |                    |                 |                    | No LEDs        | PNP LED          | NPN LED          |
|--|--|-----------------|--------------------|-----------------|--------------------|----------------|------------------|------------------|
| 6-port J-box<br>1 signal per port,<br>Integral cable                   | 2 A/signal<br>9 A total<br>Yellow PVC cable<br>9/18 AWG<br>foil shield and 20<br>AWG drain             | <u>Function</u> | <u>Color</u>       | <u>Function</u> | <u>Color</u>       | 6MB12Z-4*      | 6MB12Z-4P2.*     | 6MB12Z-4N2.*     |
|  |  | +V              | BN                 | Port 1          | WH                 |                |                  |                  |
| -V   | BU   | Port 2          | GN                 |                 |                    |                |                  |                  |
| Ground   | GN / YE  | Port 3          | YE                 |                 |                    |                |                  |                  |
|  |  | Port 4          | GY                 |                 |                    |                |                  |                  |
|  |  | Port 5          | PK                 |                 |                    |                |                  |                  |
|  |  | Port 6          | RD                 |                 |                    |                |                  |                  |
| 6-port J-box<br>1 signal per port,<br>Multifast®<br>connector          | 2 A/signal<br>9 A total<br>12-pin Multifast<br>connector<br>9 conductors.<br>Mates with<br>CKCM 12-9.* | <u>Function</u> | <u>Pin / Color</u> | <u>Function</u> | <u>Pin / Color</u> | 6MB12Z-4-CS12  | 6MB12Z-4P2-CS12  | 6MB12Z-4N2-CS12  |
|  |  | +V              | 11 / BN            | Port 1          | 1 / WH             |                |                  |                  |
| -V   | 10 / BU  | Port 2          | 2 / GN             |                 |                    |                |                  |                  |
| Ground   | 12 / GN / YE   | Port 3          | 3 / YE             |                 |                    |                |                  |                  |
|  |  | Port 4          | 4 / GY             |                 |                    |                |                  |                  |
|  |  | Port 5          | 5 / PK             |                 |                    |                |                  |                  |
|  |  | Port 6          | 6 / RD             |                 |                    |                |                  |                  |
| 6-port J-box<br>1 signal per port,<br>Multifast side<br>exit connector | 2 A/signal<br>9 A total<br>12-pin Multifast<br>connector<br>9 conductors.<br>Mates with<br>CKCM 12-9.* | <u>Function</u> | <u>Pin / Color</u> | <u>Function</u> | <u>Pin / Color</u> | 6MB12Z-4-CS12H | 6MB12Z-4P2-CS12H | 6MB12Z-4N2-CS12H |
|  |  | +V              | 11 / BN            | Port 1          | 1 / WH             |                |                  |                  |
| -V   | 10 / BU  | Port 2          | 2 / GN             |                 |                    |                |                  |                  |
| Ground   | 12 / GN / YE   | Port 3          | 3 / YE             |                 |                    |                |                  |                  |
|  |  | Port 4          | 4 / GY             |                 |                    |                |                  |                  |
|  |  | Port 5          | 5 / PK             |                 |                    |                |                  |                  |
|  |  | Port 6          | 6 / RD             |                 |                    |                |                  |                  |

\* Cable length in meters.

We reserve the right to make technical alterations without prior notice.

### Functional Wiring Diagrams

(PNP LED Version)  
1 Signal per Port

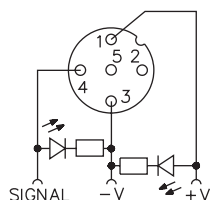

(No LED Version)  
1 Signal per Port

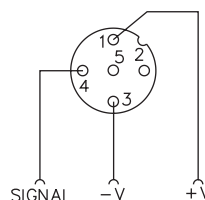



## Multibox® Eurofast® Low Profile Junction Boxes, 6-Port

### Specifications

|                        |                        |                      |   |
|------------------------|------------------------|----------------------|---|
| <b>Housing:</b>        | Nylon                  | <b>Temperature:</b>  | -40 °C to +85 °C (-40 °F to +185 °F)  |
| <b>Connectors:</b>     | Eurofast: Nylon or TPU | <b>Protection:</b>   | IEC IP68, IP69K   |
| <b>Contacts:</b>       | Gold plated brass      | <b>Accessories:</b>  | (2) VZ 3 closure caps and a VZ 12 label kit (7 labels) included                           |
| <b>Thread Inserts:</b> | Nickel plated brass    | <b>Cable Length:</b> | Standard length is nominal 5 meters. Other lengths available by request - Consult factory |
| <b>Cable:</b>          | See table              |                      |   |

### Dimensions

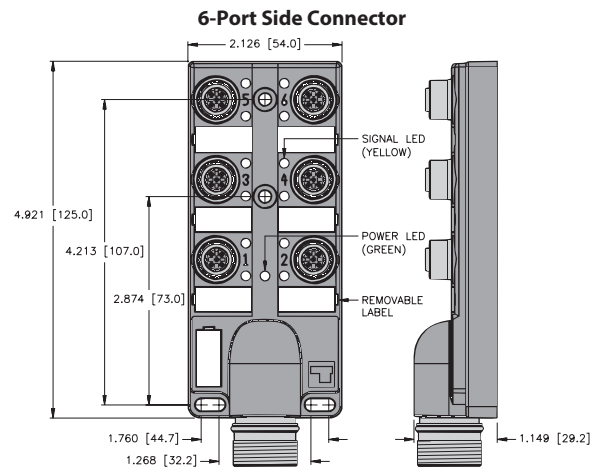
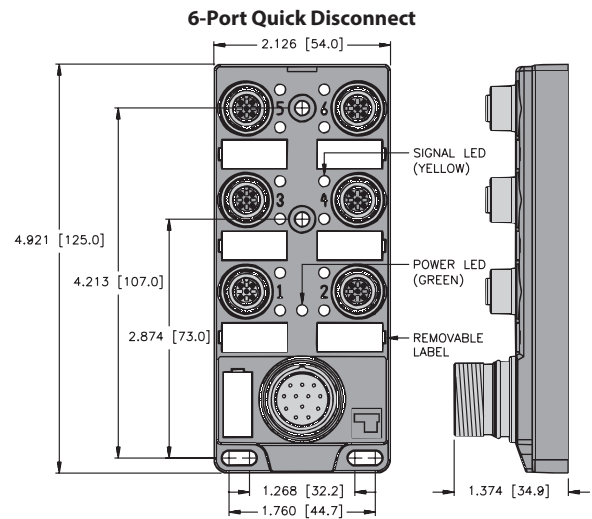
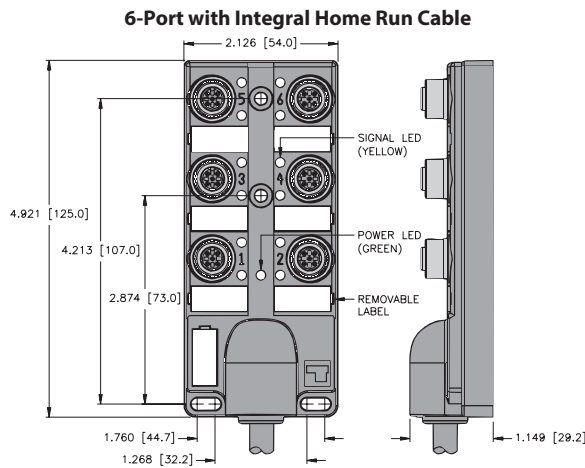

### Pinout

| 5-Pin Eurofast | 12-Pin Multifast® |
|----------------|-------------------|
| Female         | Male              |
|                |                   |

We reserve the right to make technical alterations without prior notice.

multibox®, eurofast®

# Junction Box Connectivity Products

## Multibox® Eurofast® Low Profile Junction Boxes, 6-Port

- Dual Input/Output per Port
- Rugged Plastic Housing
- Available with or without LEDs
- M23 Quick Disconnect or Integral Home Run Cable
- Threaded M12 Connection



### 6-Port, 2 Signals per Port, 10-30 VDC

| Application  | Specifications   | Pinout          |                    |                 |                    | No LEDs        | PNP LED          | NPN LED          |
|--|--|-----------------|--------------------|-----------------|--------------------|----------------|------------------|------------------|
| 6-port J-box<br>2 signals per port<br>Integral cable                       | 2 A/signal<br>9 A total<br>Yellow PVC cable<br>3/18 AWG,<br>12/22 AWG<br>foil shield and<br>22 AWG drain | <u>Function</u> | <u>Color</u>       | <u>Function</u> | <u>Color</u>       | 6MB12Z-5*      | 6MB12Z-5P3*      | 6MB12Z-5N3*      |
|  |  | +V              | BN                 | Port 3, Sig 1   | YE                 |                |                  |                  |
|  |  | -V              | BU                 | Port 3, Sig 2   | WH / GN            |                |                  |                  |
|  |  | Ground          | GN / YE            | Port 4, Sig 1   | GY                 |                |                  |                  |
|  |  | Port 1, Sig 1   | WH                 | Port 4, Sig 2   | BN / GN            |                |                  |                  |
|  |  | Port 1, Sig 2   | GY / PK            | Port 5, Sig 1   | PK                 |                |                  |                  |
|  |  | Port 2, Sig 1   | GN                 | Port 5, Sig 2   | WH/YE              |                |                  |                  |
|  |  | Port 2, Sig 2   | RD / BU            | Port 6, Sig 1   | RD                 |                |                  |                  |
|  |  |                 |                    | Port 6, Sig 2   | YE/BN              |                |                  |                  |
|  |  |                 |                    |                 |                    |                |                  |                  |
| 6-port J-box<br>2 signals per port<br>Multifast®<br>connector              | 2 A/signal<br>9 A total<br>19-pin Multifast<br>connector<br>15 conductors.<br>Mates with<br>CKM 19-15*   | <u>Function</u> | <u>Pin / Color</u> | <u>Function</u> | <u>Pin / Color</u> | 6MB12Z-5-CS19  | 6MB12Z-5P3-CS19  | 6MB12Z-5N3-CS19  |
|  |  | +V              | 19 / BN            | Port 3, Sig 1   | 16 / YE            |                |                  |                  |
|  |  | -V              | 6 / BU             | Port 3, Sig 2   | 8 / WH / GN        |                |                  |                  |
|  |  | Ground          | 12 / GN / YE       | Port 4, Sig 1   | 3 / GY             |                |                  |                  |
|  |  | Port 1, Sig 1   | 15 / WH            | Port 4, Sig 2   | 14 / BN / GN       |                |                  |                  |
|  |  | Port 1, Sig 2   | 7 / GY / PK        | Port 5, Sig 1   | 17 / PK            |                |                  |                  |
|  |  | Port 2, Sig 1   | 5 / GN             | Port 5, Sig 2   | 9 / WH/YE          |                |                  |                  |
|  |  | Port 2, Sig 2   | 4 / RD / BU        | Port 6, Sig 1   | 2 / RD             |                |                  |                  |
|  |  |                 |                    | Port 6, Sig 2   | 13 / YE/BN         |                |                  |                  |
|  |  |                 |                    |                 |                    |                |                  |                  |
| 6-port J-box<br>2 signals per port<br>Multifast,<br>side exit<br>connector | 2 A/signal<br>9 A total<br>19-pin Multifast<br>connector<br>15 conductors.<br>Mates with<br>CKM 19-15*   | <u>Function</u> | <u>Pin / Color</u> | <u>Function</u> | <u>Pin / Color</u> | 6MB12Z-5-CS19H | 6MB12Z-5P3-CS19H | 6MB12Z-5N3-CS19H |
|  |  | +V              | 19 / BN            | Port 3, Sig 1   | 16 / YE            |                |                  |                  |
|  |  | -V              | 6 / BU             | Port 3, Sig 2   | 8 / WH / GN        |                |                  |                  |
|  |  | Ground          | 12 / GN / YE       | Port 4, Sig 1   | 3 / GY             |                |                  |                  |
|  |  | Port 1, Sig 1   | 15 / WH            | Port 4, Sig 2   | 14 / BN / GN       |                |                  |                  |
|  |  | Port 1, Sig 2   | 7 / GY / PK        | Port 5, Sig 1   | 17 / PK            |                |                  |                  |
|  |  | Port 2, Sig 1   | 5 / GN             | Port 5, Sig 2   | 9 / WH/YE          |                |                  |                  |
|  |  | Port 2, Sig 2   | 4 / RD/BU          | Port 6, Sig 1   | 2 / RD             |                |                  |                  |
|  |  |                 |                    | Port 6, Sig 2   | 13 / YE/BN         |                |                  |                  |
|  |  |                 |                    |                 |                    |                |                  |                  |

We reserve the right to make technical alterations without prior notice.

### Functional Wiring Diagrams

(PNP LED Version)  
2 Signals per Port

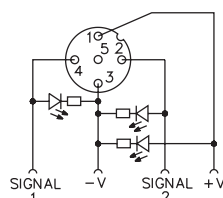

(No LED Version)  
2 Signals per Port

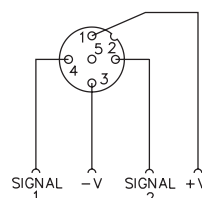

## Multibox® Eurofast® Low Profile Junction Boxes, 6-Port

### Specifications

|                              |                        |                      |   |
|------------------------------|------------------------|----------------------|---|
| <b>Housing:</b>              | Nylon                  | <b>Temperature:</b>  | -40 °C to +85 °C (-40 °F to +185 °F)  |
| <b>Connectors:</b>           | Eurofast: Nylon or TPU | <b>Protection:</b>   | IEC IP68, IP69K   |
| <b>Contacts:</b>             | Gold plated brass      | <b>Accessories:</b>  | (2) VZ 3 closure caps and a VZ 12 label kit (7 labels) included                           |
| <b>Thread Inserts:</b>       | Nickel plated brass    | <b>Cable Length:</b> | Standard length is nominal 5 meters. Other lengths available by request - Consult factory |
| <b>Cable:</b>                | See table              |                      |   |
| <b>Recommended Splitter:</b> | YB2-FSM 4.5-2 FKM 4.5  |                      |   |

### Dimensions

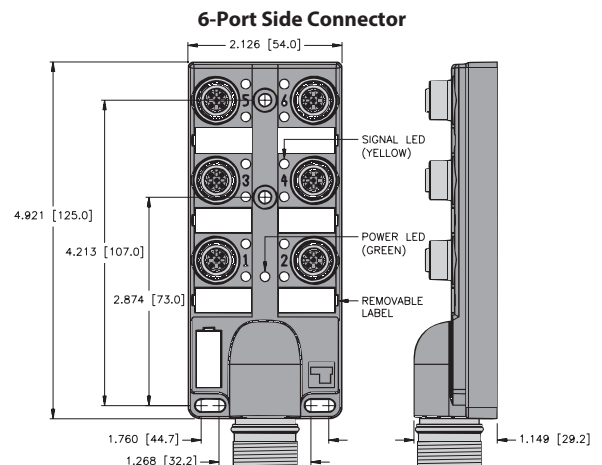
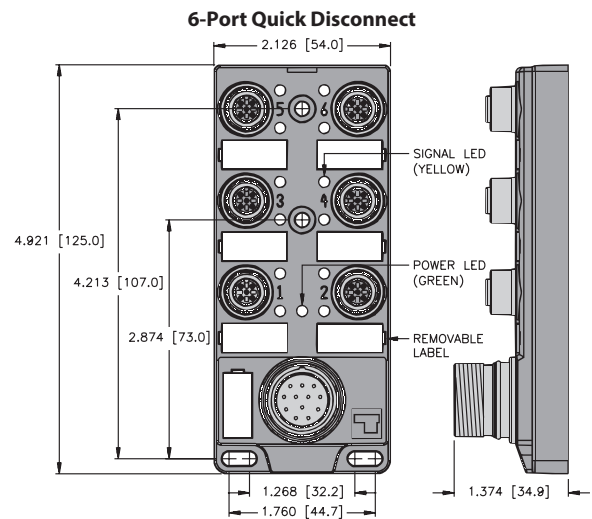
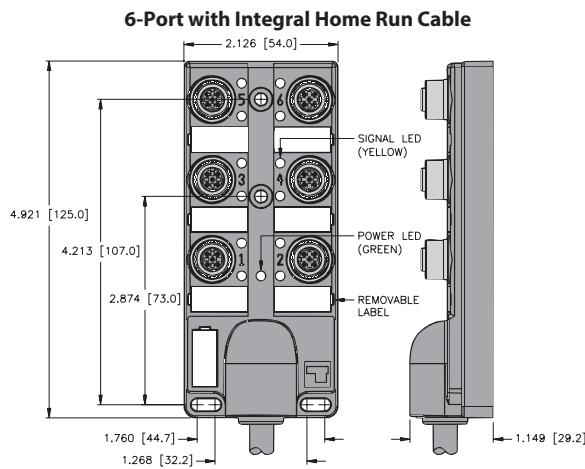

#### Pinout

| 5-Pin Eurofast | 19-Pin Multifast® |
|----------------|-------------------|
| Female         | Male              |
|                |                   |

We reserve the right to make technical alterations without prior notice.

multibox®, eurofast®

# Junction Box Connectivity Products

## Multibox® Eurofast® Low Profile Junction Boxes, 8-Port

- Single Input/Output per Port
- Rugged Plastic Housing
- Available with or without LEDs
- M23 Quick Disconnect or Integral Home Run Cable
- Threaded M12 Connection



### 8-Port, 1 Signal per Port, 10-30 VDC

| Application  | Specifications   | Pinout  |  | No LEDs   | PNP LED  | NPN LED        |                  |                  |
|--|--|---|--|---|--|----------------|------------------|------------------|
| 8-port J-box<br>1 signal per port<br>Integral cable                    | 2 A/signal, 9 A total<br>Yellow PVC cable<br>11/18 AWG,<br>foil shield and<br>20 AWG drain with<br>PUR cable, add /S90 | <u>Function</u><br>+V<br>-V<br>Ground<br>Port 1<br>Port 2<br>Port 3 | <u>Color</u><br>BN<br>BU<br>GN / YE<br>WH<br>GN<br>YE                                  | <u>Function</u><br>Port 4<br>Port 5<br>Port 6<br>Port 7<br>Port 8 | <u>Color</u><br>GY<br>PK<br>RD<br>BK<br>VT                           | 8MB12Z-4-*     | 8MB12Z-4P2-*     | 8MB12Z-4N2-*     |
| 8-port J-box<br>1 signal per port<br>Multifast®<br>connector           | 2 A/signal, 9 A total<br>12-pin Multifast<br>connector<br>11 conductors.<br>Mates with<br>CKCM 12-11-*                 | <u>Function</u><br>+V<br>-V<br>Ground<br>Port 1<br>Port 2<br>Port 3 | <u>Pin / Color</u><br>11 / BN<br>10 / BU<br>12 / GN / YE<br>1 / WH<br>2 / GN<br>3 / YE | <u>Function</u><br>Port 4<br>Port 5<br>Port 6<br>Port 7<br>Port 8 | <u>Pin / Color</u><br>4 / GY<br>5 / PK<br>6 / RD<br>7 / BK<br>8 / VT | 8MB12Z-4-CS12  | 8MB12Z-4P2-CS12  | 8MB12Z-4N2-CS12  |
| 8-port J-box<br>1 signal per port<br>Multifast, side<br>exit connector | 2 A/signal, 9 A total<br>12-pin Multifast<br>connector<br>11 conductors.<br>Mates with<br>CKCM 12-11-*                 | <u>Function</u><br>+V<br>-V<br>Ground<br>Port 1<br>Port 2<br>Port 3 | <u>Pin / Color</u><br>11 / BN<br>10 / BU<br>12 / GN / YE<br>1 / WH<br>2 / GN<br>3 / YE | <u>Function</u><br>Port 4<br>Port 5<br>Port 6<br>Port 7<br>Port 8 | <u>Pin / Color</u><br>4 / GY<br>5 / PK<br>6 / RD<br>7 / BK<br>8 / VT | 8MB12Z-4-CS12H | 8MB12Z-4P2-CS12H | 8MB12Z-4N2-CS12H |

\* Cable length in meters.

We reserve the right to make technical alterations without prior notice.

### Functional Wiring Diagrams

(PNP LED Version)  
1 Signal per Port

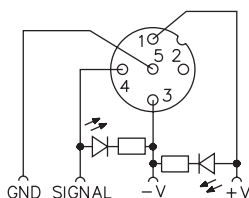

(No LED Version)  
1 Signal per Port

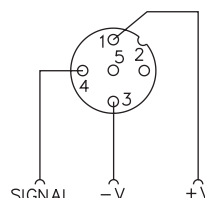

## Multibox® Eurofast® Low Profile Junction Boxes, 8-Port

### Specifications

|                        |                        |                      |   |
|------------------------|------------------------|----------------------|---|
| <b>Housing:</b>        | Nylon                  | <b>Temperature:</b>  | -40 °C to +85 °C (-40 °F to +185 °F)  |
| <b>Connectors:</b>     | Eurofast: Nylon or TPU | <b>Protection:</b>   | IEC IP68, IP69K   |
| <b>Contacts:</b>       | Gold plated brass      | <b>Accessories:</b>  | (2) VZ 3 closure caps and a VZ 12 label kit (9 labels), included                          |
| <b>Thread Inserts:</b> | Nickel plated brass    | <b>Cable Length:</b> | Standard length is nominal 5 meters. Other lengths available by request - Consult factory |
| <b>Cable:</b>          | See table              |                      |   |

### Dimensions

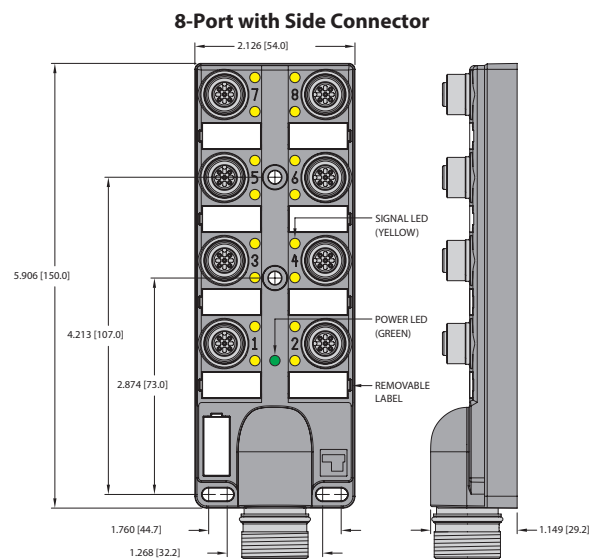
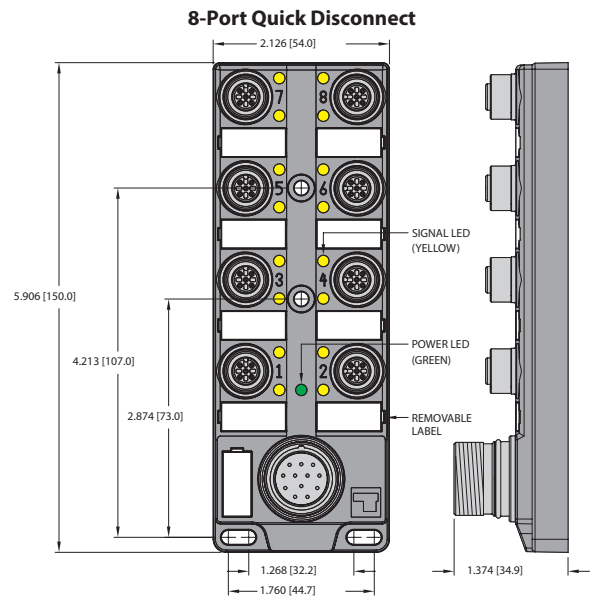
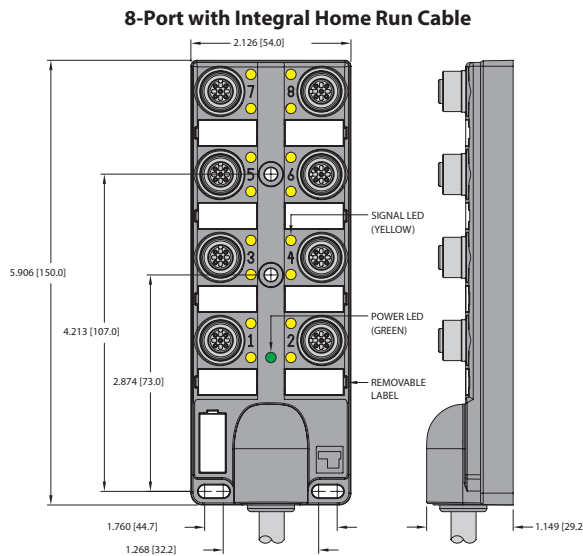

#### Pinout

| 5-Pin Eurofast | 12-pin Multifast® |
|----------------|-------------------|
| Female         | Male              |
|                |                   |

We reserve the right to make technical alterations without prior notice.

multibox®, eurofast®

# Junction Box Connectivity Products

## Multibox® Eurofast® Low Profile Junction Boxes, 8-Port

- Single Input/Output per Port
- Rugged Plastic Housing
- Available with or without LEDs
- Minifast® Quick Disconnect or Integral Home Run Cable with Minifast Connector
- Threaded M12 Connection



### 8-Port, 1 Signal per Port, 10-30 VDC

| Application   | Specifications                          | Pinout          |                    |                 |                    | No LEDs           | PNP LED             | NPN LED             |
|---|---|-----------------|--------------------|-----------------|--------------------|-------------------|---------------------|---------------------|
| 8-port J-box<br>1 signal per port<br>Minifast connector | 2 A/signal                              | <u>Function</u> | <u>Pin / Color</u> | <u>Function</u> | <u>Pin / Color</u> | 8MB12Z-4-*-RSM120 | 8MB12Z-4P2-*-RSM120 | 8MB12Z-4N2-*-RSM120 |
|   | 7 A total                               | +V              | 10 / RD            | Port 4          | 4 / RD/BK          |                   |                     |                     |
| 12-pin Minifast connector                               | 11 conductors.<br>Mates with RKM 126-*M | -V              | 11 / WH            | Port 5          | 5 / GN/BK          | 8MB12Z-4-RSF120   | 8MB12Z-4P2-RSF120   | 8MB12Z-4N2-RSF120   |
|   |   | Ground          | 9 / GN             | Port 6          | 6 / OG/BK          |                   |                     |                     |
|   |   | Port 1          | 1 / OG             | Port 7          | 7 / BU/BK          |                   |                     |                     |
|   |   | Port 2          | 2 / BU             | Port 8          | 8 / BK/WH          |                   |                     |                     |
|   |   | Port 3          | 3 / WH/BK          |                 |                    |                   |                     |                     |
|   |   |                 |                    |                 |                    |                   |                     |                     |

\* Cable length in meters.

We reserve the right to make technical alterations without prior notice.

### Functional Wiring Diagrams

(PNP LED Version)  
1 Signal per Port

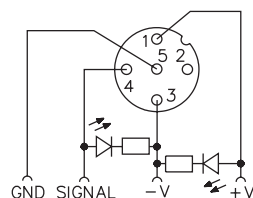

(No LED Version)  
1 Signal per Port

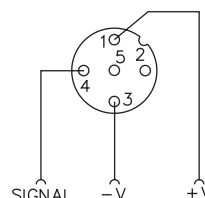

## Multibox® Eurofast® Low Profile Junction Boxes, 8-Port

### Specifications

|                        |                        |                      |   |
|------------------------|------------------------|----------------------|---|
| <b>Housing:</b>        | Nylon                  | <b>Temperature:</b>  | -40 °C to +85 °C (-40 °F to +185 °F)  |
| <b>Connectors:</b>     | Eurofast: Nylon or TPU | <b>Protection:</b>   | IEC IP68, IP69K   |
| <b>Contacts:</b>       | Gold plated brass      | <b>Accessories:</b>  | (2) VZ 3 closure caps and a VZ 1 label kit (8 labels), included                           |
| <b>Thread Inserts:</b> | Nickel plated brass    | <b>Cable Length:</b> | Standard length is nominal 5 meters. Other lengths available by request - Consult factory |
| <b>Cable:</b>          | See table              |                      |   |

### Dimensions

8-Port Integral Home Run with Minifast® Connector

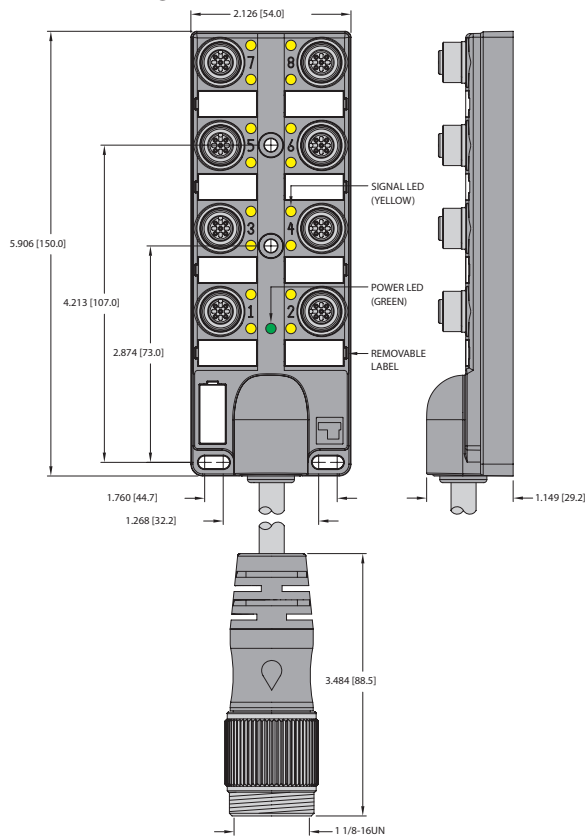

8-Port Minifast Quick Disconnect

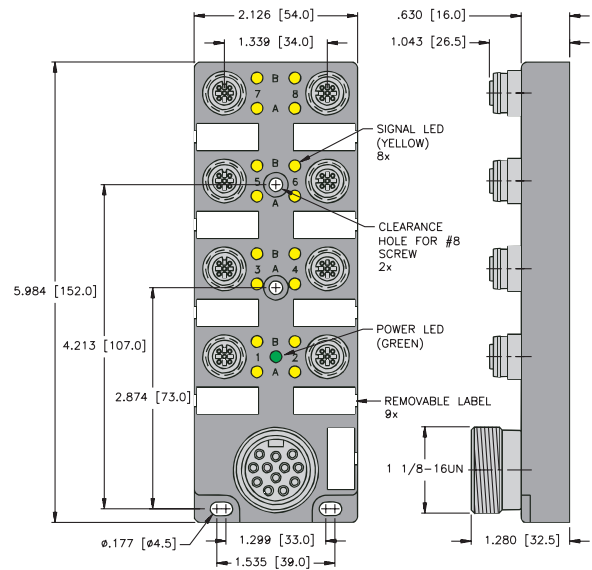

We reserve the right to make technical alterations without prior notice.

multibox®, eurofast®

### Pinout

| 5-Pin Eurofast | 12-pin Minifast |
|----------------|-----------------|
| <b>Female</b>  | <b>Male</b>     |
|                |                 |

# Junction Box Connectivity Products

## Multibox® Eurofast® Low Profile Junction Boxes 8-Port

- Dual Input/Output per Port
- Rugged Plastic Housing
- Available with or without LEDs
- M23 Quick Disconnect or Integral Home Run Cable
- Threaded M12 Connection



### 8-Port, 2 Signals per Port, 10-30 VDC

| Application  | Specifications   | Pinout          |              |                 |              | No LEDs        | PNP LED          | NPN LED          |
|--|--|-----------------|--------------|-----------------|--------------|----------------|------------------|------------------|
| 8-port J-box<br>2 signals per port<br>Integral cable                 | 2 A/signal<br>9 A total<br>Yellow PVC cable<br>3x18 AWG,<br>Integral 16x22 AWG,<br>foil shield and<br>20 AWG drain | <u>Function</u> | <u>Color</u> | <u>Function</u> | <u>Color</u> | 8MB12Z-5-*     | 8MB12Z-5P3-*     | 8MB12Z-5N3-*     |
|  |  | +V              | BN           | Port 4, Sig 1   | GY           |                |                  |                  |
| -V   | BU   | Port 4, Sig 2   | BN / GN      |                 |              |                |                  |                  |
| Ground   | GN / YE  | Port 5, Sig 1   | PK           |                 |              |                |                  |                  |
| Port 1, Sig 1  | WH   | Port 5, Sig 2   | WH / YE      |                 |              |                |                  |                  |
| Port 1, Sig 2  | GY / PK  | Port 6, Sig 1   | RD           |                 |              |                |                  |                  |
| Port 2, Sig 1  | GN   | Port 6, Sig 2   | YE / BN      |                 |              |                |                  |                  |
| Port 2, Sig 2  | RD / BU  | Port 7, Sig 1   | BK           |                 |              |                |                  |                  |
| Port 3, Sig 1  | YE   | Port 7, Sig 2   | WH / GY      |                 |              |                |                  |                  |
| Port 3, Sig 2  | WH / GN  | Port 8, Sig 1   | VT           |                 |              |                |                  |                  |
|  |  | Port 8, Sig 2   | GY / BN      |                 |              |                |                  |                  |
| 8-port J-box<br>2 signals per port<br>Multifast® connector           | 2 A/signal<br>9 A total<br>19-pin Multifast connector<br>19 conductors.<br>Mates with CKM 19-19-*                  | <u>Function</u> | <u>Color</u> | <u>Function</u> | <u>Color</u> | 8MB12Z-5-CS19  | 8MB12Z-5P3-CS19  | 8MB12Z-5N3-CS19  |
|  |  | +V              | 19 / BN      | Port 4, Sig 1   | 3 / GY       |                |                  |                  |
|  |  | -V              | 6 / BU       | Port 4, Sig 2   | 14 / BN / GN |                |                  |                  |
|  |  | Ground          | 12 / GN / YE | Port 5, Sig 1   | 17 / PK      |                |                  |                  |
|  |  | Port 1, Sig 1   | 15 / WH      | Port 5, Sig 2   | 9 / WH / YE  |                |                  |                  |
|  |  | Port 1, Sig 2   | 7 / GY / PK  | Port 6, Sig 1   | 2 / RD       |                |                  |                  |
|  |  | Port 2, Sig 1   | 5 / GN       | Port 6, Sig 2   | 13 / YE / BN |                |                  |                  |
|  |  | Port 2, Sig 2   | 4 / RD / BU  | Port 7, Sig 1   | 11 / BK      |                |                  |                  |
|  |  | Port 3, Sig 1   | 16 / YE      | Port 7, Sig 2   | 10 / WH / GY |                |                  |                  |
|  |  | Port 3, Sig 2   | 8 / WH / GN  | Port 8, Sig 1   | 1 / VT       |                |                  |                  |
|  |  | Port 8, Sig 2   | 18 / GY / BN |                 |              |                |                  |                  |
| 8-port J-box<br>2 signals per port<br>Multifast, side exit connector | 2 A/signal<br>9 A total<br>19-pin Multifast connector<br>19 conductors.<br>Mates with CKM 19-19-*                  | <u>Function</u> | <u>Color</u> | <u>Function</u> | <u>Color</u> | 8MB12Z-5-CS19H | 8MB12Z-5P3-CS19H | 8MB12Z-5N3-CS19H |
|  |  | +V              | 19 / BN      | Port 4, Sig 1   | 3 / GY       |                |                  |                  |
|  |  | -V              | 6 / BU       | Port 4, Sig 2   | 14 / BN / GN |                |                  |                  |
|  |  | Ground          | 12 / GN / YE | Port 5, Sig 1   | 17 / PK      |                |                  |                  |
|  |  | Port 1, Sig 1   | 15 / WH      | Port 5, Sig 2   | 9 / WH / YE  |                |                  |                  |
|  |  | Port 1, Sig 2   | 7 / GY / PK  | Port 6, Sig 1   | 2 / RD       |                |                  |                  |
|  |  | Port 2, Sig 1   | 5 / GN       | Port 6, Sig 2   | 13 / YE / BN |                |                  |                  |
|  |  | Port 2, Sig 2   | 4 / RD / BU  | Port 7, Sig 1   | 11 / BK      |                |                  |                  |
|  |  | Port 3, Sig 1   | 16 / YE      | Port 7, Sig 2   | 10 / WH / GY |                |                  |                  |
|  |  | Port 3, Sig 2   | 8 / WH / GN  | Port 8, Sig 1   | 1 / VT       |                |                  |                  |
|  |  | Port 8, Sig 2   | 18 / GY / BN |                 |              |                |                  |                  |

We reserve the right to make technical alterations without prior notice.

\* Cable length in meters.

### Functional Wiring Diagrams

(PNP LED Version)  
2 Signals per Port

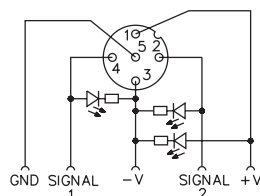

(No LED Version)  
2 Signals per Port

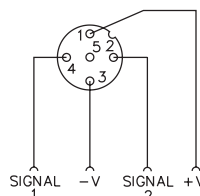



## Multibox® Eurofast® Low Profile Junction Boxes 8-Port

### Specifications

|                              |                        |                      |   |
|------------------------------|------------------------|----------------------|---|
| <b>Housing:</b>              | Nylon                  | <b>Temperature:</b>  | -40 °C to +85 °C (-40 °F to +185 °F)  |
| <b>Connectors:</b>           | Eurofast: Nylon or TPU | <b>Protection:</b>   | IEC IP68, IP69K   |
| <b>Contacts:</b>             | Gold plated brass      | <b>Accessories:</b>  | (2) VZ 3 closure caps and a VZ 12 label kit (9 labels), included                          |
| <b>Thread Inserts:</b>       | Nickel plated brass    | <b>Cable Length:</b> | Standard length is nominal 5 meters. Other lengths available by request - Consult factory |
| <b>Cable:</b>                | See table              |                      |   |
| <b>Recommended Splitter:</b> | YB2-FSM 4.5-2FKM 4.5   |                      |   |

### Dimensions

8-Port with Integral Home Run Cable

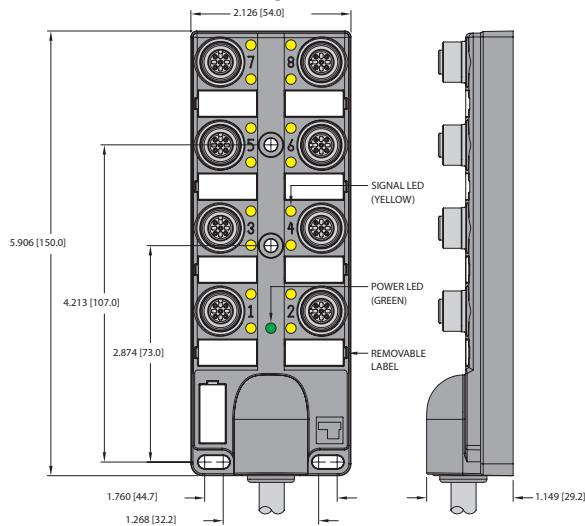

8-Port Quick Disconnect

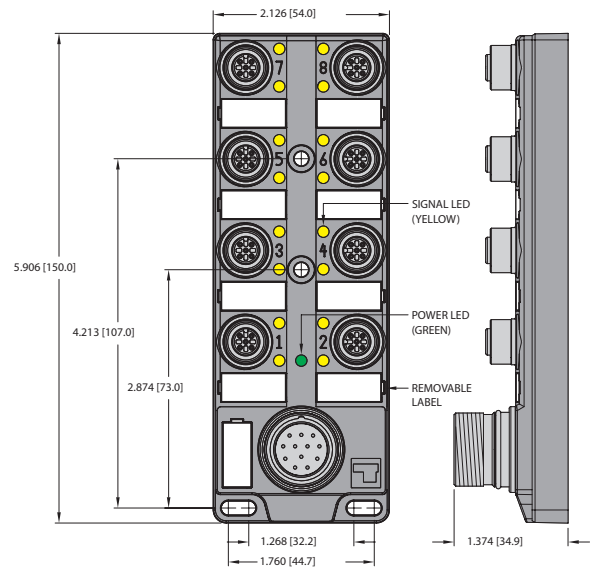

8-Port Side Connector

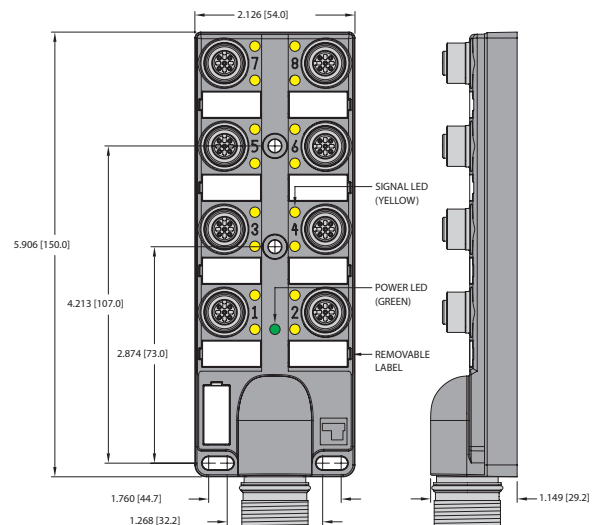

### Pinout

| 5-Pin Eurofast | 19-Pin Multifast® |
|----------------|-------------------|
| Female         | Male              |
|                |                   |

We reserve the right to make technical alterations without prior notice.

multibox®, eurofast®

# Junction Box Connectivity Products

## Multibox® Eurofast®, Junction Boxes, 4-Port Stainless Steel Connector Options

- 1 or 2 Signals per Port
- Rugged Plastic Housing with Flush Connectors
- Available with LEDs
- M23 Quick Disconnect or Integral Home Run Cable
- Available with Stainless Steel Threaded Connections



### 4-Port, 1 Signal per Port, 10-48 VDC

| Application   | Specifications  | Pinout   | Part Number |             |          |             |    |         |        |        |    |         |        |        |        |              |        |        |  |  |        |        |                  |
|---|---|--|-------------|-------------|----------|-------------|----|---------|--------|--------|----|---------|--------|--------|--------|--------------|--------|--------|--|--|--------|--------|------------------|
| 4-port J-box<br>1 signal per port<br>Integral cable       | 4 A/port, 9 A total Yellow PVC cable**<br>7x18 AWG foil shield and 20 AWG drain<br><br>**with PUR cable, add /S90 | <table border="1"> <thead> <tr> <th>Function</th> <th>Color</th> <th>Function</th> <th>Color</th> </tr> </thead> <tbody> <tr> <td>+V</td> <td>BN</td> <td>Port 1</td> <td>WH</td> </tr> <tr> <td>-V</td> <td>BU</td> <td>Port 2</td> <td>GN</td> </tr> <tr> <td>Ground</td> <td>GN / YE</td> <td>Port 3</td> <td>YE</td> </tr> <tr> <td></td> <td></td> <td>Port 4</td> <td>GY</td> </tr> </tbody> </table>  | Function    | Color       | Function | Color       | +V | BN      | Port 1 | WH     | -V | BU      | Port 2 | GN     | Ground | GN / YE      | Port 3 | YE     |  |  | Port 4 | GY     | 4MBV12-4P2-*     |
| Function  | Color   | Function   | Color       |             |          |             |    |         |        |        |    |         |        |        |        |              |        |        |  |  |        |        |                  |
| +V  | BN  | Port 1   | WH          |             |          |             |    |         |        |        |    |         |        |        |        |              |        |        |  |  |        |        |                  |
| -V  | BU  | Port 2   | GN          |             |          |             |    |         |        |        |    |         |        |        |        |              |        |        |  |  |        |        |                  |
| Ground  | GN / YE   | Port 3   | YE          |             |          |             |    |         |        |        |    |         |        |        |        |              |        |        |  |  |        |        |                  |
|   |   | Port 4   | GY          |             |          |             |    |         |        |        |    |         |        |        |        |              |        |        |  |  |        |        |                  |
| 4-port J-box<br>1 signal per port<br>Multifast® connector | 4 A/port, 8 A total 12-pin Multifast connector 7 conductors. Mates with CKCMV12-7-*                               | <table border="1"> <thead> <tr> <th>Function</th> <th>Pin / Color</th> <th>Function</th> <th>Pin / Color</th> </tr> </thead> <tbody> <tr> <td>+V</td> <td>11 / BN</td> <td>Port 1</td> <td>1 / WH</td> </tr> <tr> <td>-V</td> <td>10 / BU</td> <td>Port 2</td> <td>2 / GN</td> </tr> <tr> <td>Ground</td> <td>12 / GN / YE</td> <td>Port 3</td> <td>3 / YE</td> </tr> <tr> <td></td> <td></td> <td>Port 4</td> <td>4 / GY</td> </tr> </tbody> </table> | Function    | Pin / Color | Function | Pin / Color | +V | 11 / BN | Port 1 | 1 / WH | -V | 10 / BU | Port 2 | 2 / GN | Ground | 12 / GN / YE | Port 3 | 3 / YE |  |  | Port 4 | 4 / GY | 4MBV12-4P2-CSV12 |
| Function  | Pin / Color   | Function   | Pin / Color |             |          |             |    |         |        |        |    |         |        |        |        |              |        |        |  |  |        |        |                  |
| +V  | 11 / BN   | Port 1   | 1 / WH      |             |          |             |    |         |        |        |    |         |        |        |        |              |        |        |  |  |        |        |                  |
| -V  | 10 / BU   | Port 2   | 2 / GN      |             |          |             |    |         |        |        |    |         |        |        |        |              |        |        |  |  |        |        |                  |
| Ground  | 12 / GN / YE  | Port 3   | 3 / YE      |             |          |             |    |         |        |        |    |         |        |        |        |              |        |        |  |  |        |        |                  |
|   |   | Port 4   | 4 / GY      |             |          |             |    |         |        |        |    |         |        |        |        |              |        |        |  |  |        |        |                  |

### 4-Port, 2 Signal per Port, 10-48 VDC

| Application   | Specifications  | Pinout   | Part Number  |             |          |             |    |         |               |        |    |        |               |             |        |            |               |         |               |         |               |             |               |           |               |        |  |  |               |              |                  |
|---|---|--|--------------|-------------|----------|-------------|----|---------|---------------|--------|----|--------|---------------|-------------|--------|------------|---------------|---------|---------------|---------|---------------|-------------|---------------|-----------|---------------|--------|--|--|---------------|--------------|------------------|
| 4-port J-box<br>2 signals per port<br>Integral cable      | 4 A/port, 9 A total Yellow PVC cable**<br>3x18 AWG, 8x22 AWG foil shield and 20 AWG drain<br><br>**with PUR cable, add /S90 | <table border="1"> <thead> <tr> <th>Function</th> <th>Color</th> <th>Function</th> <th>Color</th> </tr> </thead> <tbody> <tr> <td>+V</td> <td>BN</td> <td>port 2, Sig 1</td> <td>GN</td> </tr> <tr> <td>-V</td> <td>BU</td> <td>port 2, Sig 2</td> <td>RD / BU</td> </tr> <tr> <td>Ground</td> <td>GN/YE</td> <td>port 3, Sig 1</td> <td>YE</td> </tr> <tr> <td>port 1, Sig 1</td> <td>WH</td> <td>port 3, Sig 2</td> <td>WH / GN</td> </tr> <tr> <td>port 1, Sig 2</td> <td>GY / PK</td> <td>port 4, Sig 1</td> <td>GY</td> </tr> <tr> <td></td> <td></td> <td>port 4, Sig 2</td> <td>BN / GN</td> </tr> </tbody> </table>  | Function     | Color       | Function | Color       | +V | BN      | port 2, Sig 1 | GN     | -V | BU     | port 2, Sig 2 | RD / BU     | Ground | GN/YE      | port 3, Sig 1 | YE      | port 1, Sig 1 | WH      | port 3, Sig 2 | WH / GN     | port 1, Sig 2 | GY / PK   | port 4, Sig 1 | GY     |  |  | port 4, Sig 2 | BN / GN      | 4MBV12-5P3-*     |
| Function  | Color   | Function   | Color        |             |          |             |    |         |               |        |    |        |               |             |        |            |               |         |               |         |               |             |               |           |               |        |  |  |               |              |                  |
| +V  | BN  | port 2, Sig 1  | GN           |             |          |             |    |         |               |        |    |        |               |             |        |            |               |         |               |         |               |             |               |           |               |        |  |  |               |              |                  |
| -V  | BU  | port 2, Sig 2  | RD / BU      |             |          |             |    |         |               |        |    |        |               |             |        |            |               |         |               |         |               |             |               |           |               |        |  |  |               |              |                  |
| Ground  | GN/YE   | port 3, Sig 1  | YE           |             |          |             |    |         |               |        |    |        |               |             |        |            |               |         |               |         |               |             |               |           |               |        |  |  |               |              |                  |
| port 1, Sig 1   | WH  | port 3, Sig 2  | WH / GN      |             |          |             |    |         |               |        |    |        |               |             |        |            |               |         |               |         |               |             |               |           |               |        |  |  |               |              |                  |
| port 1, Sig 2   | GY / PK   | port 4, Sig 1  | GY           |             |          |             |    |         |               |        |    |        |               |             |        |            |               |         |               |         |               |             |               |           |               |        |  |  |               |              |                  |
|   |   | port 4, Sig 2  | BN / GN      |             |          |             |    |         |               |        |    |        |               |             |        |            |               |         |               |         |               |             |               |           |               |        |  |  |               |              |                  |
| 4-port J-box<br>2 signals per port<br>Multifast connector | 4 A/port, 8 A total 19-pin Multifast connector 11 conductors. Mates with CKMV 19-11-*                                       | <table border="1"> <thead> <tr> <th>Function</th> <th>Pin / Color</th> <th>Function</th> <th>Pin / Color</th> </tr> </thead> <tbody> <tr> <td>+V</td> <td>19 / BN</td> <td>Port 2, Sig 1</td> <td>5 / GN</td> </tr> <tr> <td>-V</td> <td>6 / BU</td> <td>Port 2, Sig 2</td> <td>4 / RD / BU</td> </tr> <tr> <td>Ground</td> <td>12 / GN/YE</td> <td>Port 3, Sig 1</td> <td>16 / YE</td> </tr> <tr> <td>Port 1, Sig 1</td> <td>15 / WH</td> <td>Port 3, Sig 2</td> <td>8 / WH / GN</td> </tr> <tr> <td>Port 1, Sig 2</td> <td>7 / GY/PK</td> <td>Port 4, Sig 1</td> <td>3 / GY</td> </tr> <tr> <td></td> <td></td> <td>Port 4, Sig 2</td> <td>14 / BN / GN</td> </tr> </tbody> </table> | Function     | Pin / Color | Function | Pin / Color | +V | 19 / BN | Port 2, Sig 1 | 5 / GN | -V | 6 / BU | Port 2, Sig 2 | 4 / RD / BU | Ground | 12 / GN/YE | Port 3, Sig 1 | 16 / YE | Port 1, Sig 1 | 15 / WH | Port 3, Sig 2 | 8 / WH / GN | Port 1, Sig 2 | 7 / GY/PK | Port 4, Sig 1 | 3 / GY |  |  | Port 4, Sig 2 | 14 / BN / GN | 4MBV12-5P3-CSV19 |
| Function  | Pin / Color   | Function   | Pin / Color  |             |          |             |    |         |               |        |    |        |               |             |        |            |               |         |               |         |               |             |               |           |               |        |  |  |               |              |                  |
| +V  | 19 / BN   | Port 2, Sig 1  | 5 / GN       |             |          |             |    |         |               |        |    |        |               |             |        |            |               |         |               |         |               |             |               |           |               |        |  |  |               |              |                  |
| -V  | 6 / BU  | Port 2, Sig 2  | 4 / RD / BU  |             |          |             |    |         |               |        |    |        |               |             |        |            |               |         |               |         |               |             |               |           |               |        |  |  |               |              |                  |
| Ground  | 12 / GN/YE  | Port 3, Sig 1  | 16 / YE      |             |          |             |    |         |               |        |    |        |               |             |        |            |               |         |               |         |               |             |               |           |               |        |  |  |               |              |                  |
| Port 1, Sig 1   | 15 / WH   | Port 3, Sig 2  | 8 / WH / GN  |             |          |             |    |         |               |        |    |        |               |             |        |            |               |         |               |         |               |             |               |           |               |        |  |  |               |              |                  |
| Port 1, Sig 2   | 7 / GY/PK   | Port 4, Sig 1  | 3 / GY       |             |          |             |    |         |               |        |    |        |               |             |        |            |               |         |               |         |               |             |               |           |               |        |  |  |               |              |                  |
|   |   | Port 4, Sig 2  | 14 / BN / GN |             |          |             |    |         |               |        |    |        |               |             |        |            |               |         |               |         |               |             |               |           |               |        |  |  |               |              |                  |

\* Cable length in meters.

We reserve the right to make technical alterations without prior notice.

### Functional Wiring Diagrams

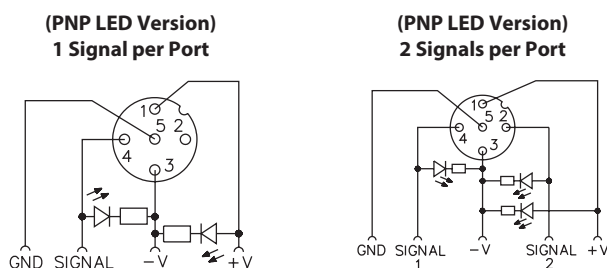

### Specifications

|                              |                        |                      |   |
|------------------------------|------------------------|----------------------|---|
| <b>Housing:</b>              | Nylon                  | <b>Temperature:</b>  | -30 °C to +80 °C (-22 °F to +176 °F)  |
| <b>Connectors:</b>           | Eurofast: Nylon or TPU | <b>Protection:</b>   | IEC IP67  |
| <b>Contacts:</b>             | Gold plated brass      | <b>Accessories:</b>  | (2) VZ 3 closure caps and a VZ 1 label kit (8 labels) included                            |
| <b>Thread Inserts:</b>       | Stainless steel        | <b>Cable Length:</b> | Standard length is nominal 5 meters. Other lengths available by request - Consult factory |
| <b>Cable:</b>                | See table              |                      |   |
| <b>Recommended Splitter:</b> | YB2-FSM 4.5-2 FKM 4.5  |                      |   |

### Dimensions

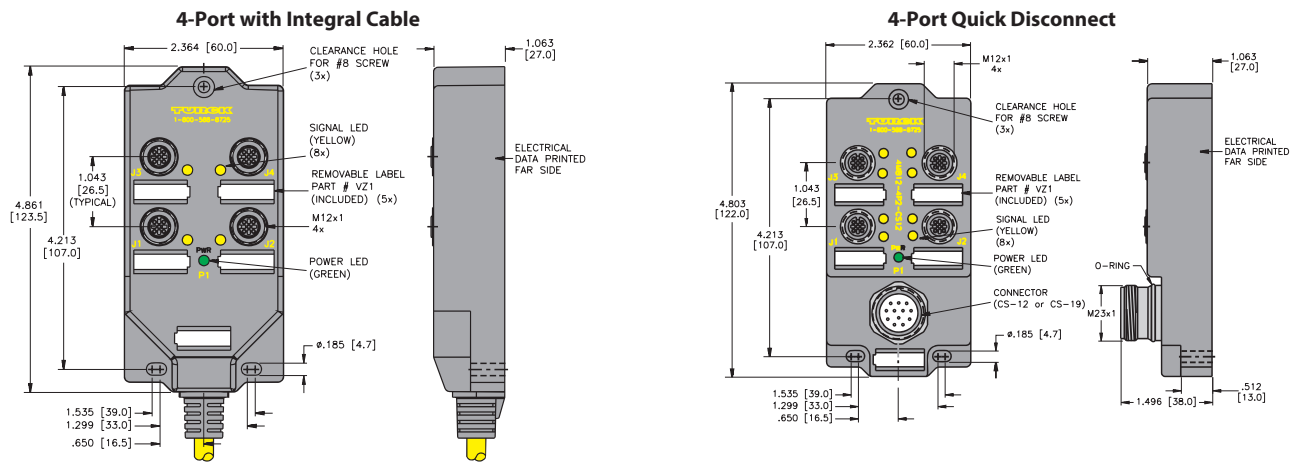

We reserve the right to make technical alterations without prior notice.

multibox®, eurofast®

### Pinout

| 5-Pin Eurofast | 12-Pin Multifast® | 19-Pin Multifast |
|----------------|-------------------|------------------|
| Female         | Male              | Male             |
|                |                   |                  |

# Junction Box Connectivity Products

## Multibox® Eurofast® 8-Port Junction Boxes, Stainless Steel Connector Options

- 1 or 2 Signals per Port
- Rugged Plastic Housing with Flush Connectors
- Available with LEDs
- M23 Quick Disconnect or Integral Home Run Cable
- Available with Stainless Steel Threaded Connections



### 8-Port, 1 Signal per Port, 10-48 VDC

| Application   | Specifications  | Pinout  |  |   |  | Part Number      |
|---|---|---|--|---|--|------------------|
| 8-port J-box<br>1 signal per port<br>Integral cable       | 4 A/port, 9 A total Yellow PVC cable**<br>11x18 AWG, foil shield and 20 AWG drain<br><br>**with PUR cable, add /S90 | <u>Function</u><br>+V<br>-V<br>Ground<br>Port 1<br>Port 2<br>Port 3 | <u>Color</u><br>BN<br>BU<br>GN / YE<br>WH<br>GN<br>YE                                  | <u>Function</u><br>Port 4<br>Port 5<br>Port 6<br>Port 7<br>Port 8 | <u>Color</u><br>GY<br>PK<br>RD<br>BK<br>VT                           | 8MBV12-4P2-*     |
| 8-port J-box<br>1 signal per port<br>Multifast® connector | 4 A/port, 8 A total 12-pin Multifast connector 11 conductors. Mates with CKCMV 12-11-*                              | <u>Function</u><br>+V<br>-V<br>Ground<br>Port 1<br>Port 2<br>Port 3 | <u>Pin / Color</u><br>11 / BN<br>10 / BU<br>12 / GN / YE<br>1 / WH<br>2 / GN<br>3 / YE | <u>Function</u><br>Port 4<br>Port 5<br>Port 6<br>Port 7<br>Port 8 | <u>Pin / Color</u><br>4 / GY<br>5 / PK<br>6 / RD<br>7 / BK<br>8 / VT | 8MBV12-4P2-CSV12 |

### 8-Port, 2 Signal per Port, 10-48 VDC

| Application   | Specifications  | Pinout  |  |   |   | Part Number      |
|---|---|---|--|---|---|------------------|
| 8-port J-box<br>2 signals per port<br>Integral cable      | 4 A/port, 9 A total Yellow PVC cable**<br>3x18 AWG, 16x22 AWG, foil shield and 20 AWG drain<br><br>**with PUR cable, add /S90 | <u>Function</u><br>+V<br>-V<br>Ground<br>Port 1, Sig 1<br>Port 1, Sig 2<br>Port 2, Sig 1<br>Port 2, Sig 2<br>Port 3, Sig 1<br>Port 3, Sig 2 | <u>Color</u><br>BN<br>BU<br>GN / YE<br>WH<br>GY / PK<br>GN<br>RD / BU<br>YE<br>WH / GN                                       | <u>Function</u><br>Port 4, Sig 1<br>Port 4, Sig 2<br>Port 5, Sig 1<br>Port 5, Sig 2<br>Port 6, Sig 1<br>Port 6, Sig 2<br>Port 7, Sig 1<br>Port 7, Sig 2<br>Port 8, Sig 1<br>Port 8, Sig 2 | <u>Color</u><br>GY<br>BN / GN<br>PK<br>WH / YE<br>RD<br>YE / BN<br>BN<br>WH / GY<br>VT<br>GY / BN   | 8MBV12-5P3-*     |
| 8-port J-box<br>2 signals per port<br>Multifast connector | 4 A/port, 8 A total 19-pin Multifast connector 19 conductors. Mates with CKMV 19-19-*   | <u>Function</u><br>+V<br>-V<br>Ground<br>Port 1, Sig 1<br>Port 1, Sig 2<br>Port 2, Sig 1<br>Port 2, Sig 2<br>Port 3, Sig 1<br>Port 3, Sig 2 | <u>Pin / Color</u><br>19 / BN<br>6 / BU<br>12 / GN/YE<br>15 / WH<br>7 / GY/PK<br>5 / GN<br>4 / RD/BU<br>16 / YE<br>8 / WH/GN | <u>Function</u><br>Port 4, Sig 1<br>Port 4, Sig 2<br>Port 5, Sig 1<br>Port 5, Sig 2<br>Port 6, Sig 1<br>Port 6, Sig 2<br>Port 7, Sig 1<br>Port 7, Sig 2<br>Port 8, Sig 1<br>Port 8, Sig 2 | <u>Pin / Color</u><br>3 / GY<br>14 / BN / GN<br>17 / PK<br>9 / WH / YE<br>2 / RD<br>13 / YE / BN<br>11 / BK<br>10 / WH / GY<br>1 / VT<br>18 / GY / BN | 8MBV12-5P3-CSV19 |

\* Cable length in meters.

We reserve the right to make technical alterations without prior notice.

### Functional Wiring Diagrams

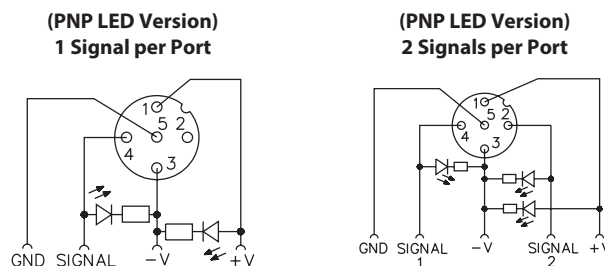

### Specifications

|                              |                        |                      |   |
|------------------------------|------------------------|----------------------|---|
| <b>Housing:</b>              | Nylon                  | <b>Temperature:</b>  | -30 °C to +80 °C (-22 °F to +176 °F)  |
| <b>Connectors:</b>           | Eurofast: Nylon or TPU | <b>Protection:</b>   | IEC IP67  |
| <b>Contacts:</b>             | Gold plated brass      | <b>Accessories:</b>  | (2) VZ 3 closure caps and a VZ 1 label kit (8 labels), included                           |
| <b>Thread Inserts:</b>       | Stainless steel        | <b>Cable Length:</b> | Standard length is nominal 5 meters. Other lengths available by request - Consult factory |
| <b>Cable:</b>                | See table              |                      |   |
| <b>Recommended Splitter:</b> | YB2-FSM 4.5-2 FKM 4.5  |                      |   |

### Dimensions

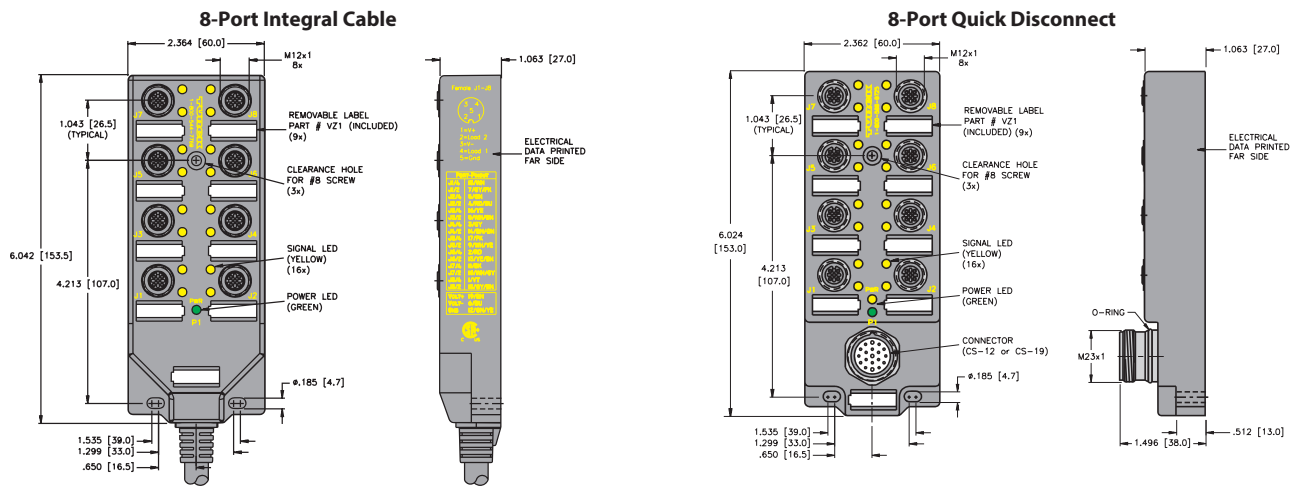

multibox®, eurofast®

### Pinout

| 5-Pin Eurofast | 12-Pin Multifast® | 19-Pin Multifast |
|----------------|-------------------|------------------|
| Female         | Male              | Male             |
|                |                   |                  |

# Junction Box Connectivity Products

## Multibox® Eurofast® Junction Boxes, Back Exit Home Run

- 8-Port Plastic Housing
- 9 Amps Total
- Back Exit Home Run Cable or Leads
- Nickel Plated Brass or Stainless Steel Connectors



### 8-Port, 10-48 VDC, 2 Signals per Port, Back Exit Home Run Leads

| Application   | Specifications   | Pinout          | Part Number - Nickel Plated | Part Number - Stainless Steel |
|---|--|-----------------|-----------------------------|-------------------------------|
| 8-port J-box<br>2 signals per port<br>Back exit leads | 4 A/port, 9 A total<br>5-pin Eurofast connector,<br>1 (green) power LED<br>2 (yellow) signal per port LEDs,<br>3x18 AWG, 16x22 AWG | <u>Function</u> |                             |                               |
|   |  | +V              | 19 / BN                     |                               |
|   |  | -V              | 6 / BU                      |                               |
|   |  | Ground          | 12 / GN / YE                |                               |
|   |  | Port 1, Sig 1   | 15 / WH                     |                               |
|   |  | Port 1, Sig 2   | 7 / GY / PK                 |                               |
|   |  | Port 2, Sig 1   | 5 / GN                      |                               |
|   |  | Port 2, Sig 2   | 4 / RD / BU                 |                               |
|   |  | Port 3, Sig 1   | 16 / YE                     |                               |
|   |  | Port 3, Sig 2   | 8 / WH / GN                 |                               |
|   |  | Port 4, Sig 1   | 3 / GY                      |                               |
|   |  | Port 4, Sig 2   | 14 / BN / GN                |                               |
|   |  | Port 5, Sig 1   | 17 / PK                     |                               |
|   |  | Port 5, Sig 2   | 9 / WH / YE                 |                               |
|   |  | Port 6, Sig 1   | 2 / RD                      |                               |
|   |  | Port 6, Sig 2   | 13 / YE / BN                |                               |
|   |  | Port 7, Sig 1   | 11 / BK                     |                               |
| Port 7, Sig 2   | 10 / WH / GY   |                 |                             |                               |
| Port 8, Sig 1   | 1 / VT   |                 |                             |                               |
| Port 8, Sig 2   | 18 / GY / BN   |                 |                             |                               |
|   |  |                 | 8MB12-5P3-*BL               | 8MBV12-5P3-*BL                |

### 8-Port, 10-48 VDC, 2 Signals per Port, Back Exit Home Run Cable

| Application   | Specifications  | Pinout          | Part Number - Nickel Plated | Part Number - Stainless Steel |
|---|---|-----------------|-----------------------------|-------------------------------|
| 8-port J-box<br>2 signals per port<br>Back exit cable | 4 A/port, 9 A total<br>5-pin Eurofast connector,<br>1 (green) power LED<br>2 (yellow) signal per port LEDs,<br>3x18 AWG, 16x22 AWG,<br>PVC Yellow Cable | <u>Function</u> |                             |                               |
|   |   | +V              | 19 / BN                     |                               |
|   |   | -V              | 6 / BU                      |                               |
|   |   | Ground          | 12 / GN / YE                |                               |
|   |   | Port 1, Sig 1   | 15 / WH                     |                               |
|   |   | Port 1, Sig 2   | 7 / GY / PK                 |                               |
|   |   | Port 2, Sig 1   | 5 / GN                      |                               |
|   |   | Port 2, Sig 2   | 4 / RD / BU                 |                               |
|   |   | Port 3, Sig 1   | 16 / YE                     |                               |
|   |   | Port 3, Sig 2   | 8 / WH / GN                 |                               |
|   |   | Port 4, Sig 1   | 3 / GY                      |                               |
|   |   | Port 4, Sig 2   | 14 / BN / GN                |                               |
|   |   | Port 5, Sig 1   | 17 / PK                     |                               |
|   |   | Port 5, Sig 2   | 9 / WH / YE                 |                               |
|   |   | Port 6, Sig 1   | 2 / RD                      |                               |
|   |   | Port 6, Sig 2   | 13 / YE / BN                |                               |
|   |   | Port 7, Sig 1   | 11 / BK                     |                               |
| Port 7, Sig 2   | 10 / WH / GY  |                 |                             |                               |
| Port 8, Sig 1   | 1 / VT  |                 |                             |                               |
| Port 8, Sig 2   | 18 / GY / BN  |                 |                             |                               |
|   |   |                 | 8MB12-5P3-*B                | 8MBV12-5P3-*B                 |

\* Cable length in meters.

(PNP LED Version)  
2 Signals per Port

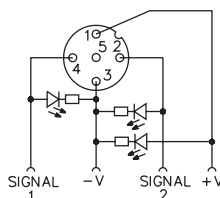

We reserve the right to make technical alterations without prior notice.

### Specifications

|                            |                                 |                              |                                      |
|----------------------------|---------------------------------|------------------------------|--------------------------------------|
| <b>Housing:</b>            | Nylon                           | <b>Temperature:</b>          | -30 °C to +80 °C (-22 °C to +176 °F) |
| <b>Connectors:</b>         | Eurofast: Nylon or TPU          | <b>Protection:</b>           | IP67                                 |
| <b>Contacts:</b>           | Gold plated brass               | <b>Accessories:</b>          | Includes (2) VZ 3 closure caps       |
| <b>Thread Inserts:</b>     | Nickel plated brass             | <b>Recommended Splitter:</b> | YB2-FSM 4.5-2 FKM 4.5                |
| <b>Cable:</b>              | See table                       |                              |                                      |
| <b>Recommended Gasket:</b> | Gasket, 8MB12, Neoprene (A9446) |                              |                                      |

### Dimensions

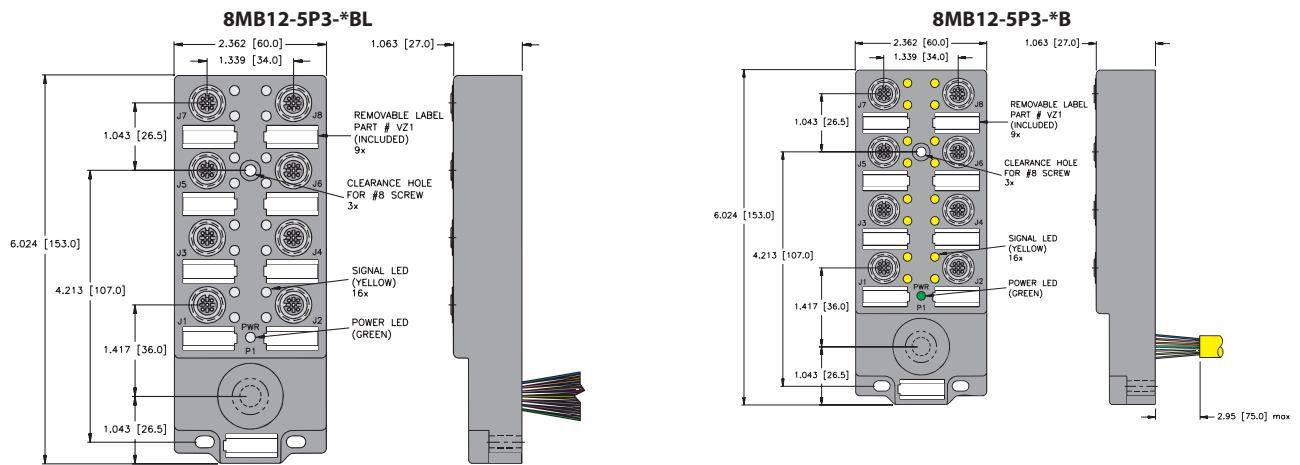

We reserve the right to make technical alterations without prior notice.

multibox®, eurofast®

### Pinout

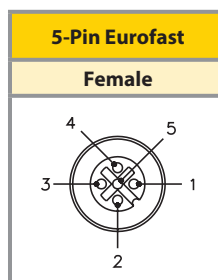

# Junction Box Connectivity Products

## Multibox® Eurofast® Junction Boxes, NAMUR, 1 Circuit per Port

- 4 Ports
- Rugged Plastic Housing with Flush Connectors
- M12 or M23 Quick Disconnect or Integral Home Run Cable
- For use with NAMUR Sensors



### 1 circuit per Port, common positive, 100 VDC

| Application  | Specifications   | Pinout                |                              |   |  | Part Number  |
|--|--|-----------------------|------------------------------|---|--|--------------|
| 1 circuit per port, common positive, 100 VDC             | 4 A/port, 9 A total<br>Blue PVC cable, PLTC<br>5x22 AWG                                  | <u>Function</u><br>+V | <u>Color</u><br>GN           | <u>Function</u><br>J1/Pin 2<br>J2/Pin 2<br>J3/Pin 2<br>J4/Pin 2 | <u>Color</u><br>WH<br>OG<br>BK<br>RD                       | VB 40N-*     |
| 4-port J-box<br>1 circuit per port<br>Eurofast connector | 4 A/port, 4 A total<br>5-pin Eurofast connector<br>5 conductors. Mates with<br>RKCN 5T-* | <u>Function</u><br>+V | <u>Pin / Color</u><br>1 / GN | <u>Function</u><br>J1/Pin 2<br>J2/Pin 2<br>J3/Pin 2<br>J4/Pin 2 | <u>Pin / Color</u><br>2 / WH<br>3 / OG<br>4 / BK<br>5 / RD | VB 40N-H1151 |

### 1 circuit per Port, isolated circuits, 100 VDC

| Application   | Specifications   | Pinout  |  |   |  | Part Number  |
|---|--|---|--|---|--|--------------|
| 4-port J-box<br>1 circuit per port<br>Integral cable          | 4 A/port, 9 A total<br>Blue PVC cable, PLTC<br>9x22 AWG                                      | <u>Function</u><br>J1/Pin 1<br>J1/Pin 2<br>J2/Pin 1<br>J2/Pin 2 | <u>Pin / Color</u><br>WH<br>BK<br>GN<br>RD                 | <u>Function</u><br>J3/Pin 1<br>J3/Pin 2<br>J4/Pin 1<br>J4/Pin 2 | <u>Pin / Color</u><br>OG<br>BU<br>YE<br>VT                 | VB 4X1N-*    |
| Brown not used  |  |   |  |   |  |              |
| 4-port J-box<br>1 circuit per port<br>Multifast®<br>connector | 4 A/port, 8 A total<br>12-pin Multifast connector<br>9 conductors. Mates with<br>CKNM 12-9-* | <u>Function</u><br>J1/Pin 1<br>J1/Pin 2<br>J2/Pin 1<br>J2/Pin 2 | <u>Pin / Color</u><br>2 / WH<br>3 / BK<br>4 / GN<br>5 / RD | <u>Function</u><br>J3/Pin 1<br>J3/Pin 2<br>J4/Pin 1<br>J4/Pin 2 | <u>Pin / Color</u><br>6 / OG<br>7 / BU<br>8 / YE<br>9 / VT | VB 4X1N-CS12 |
| Pin 1/BN not used   |  |   |  |   |  |              |

We reserve the right to make technical alterations without prior notice.

## Functional Wiring Diagrams

(PNP LED Version)  
1 Signal per Port

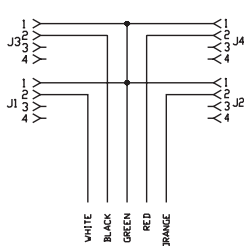

VB 40N-\*

Common Positive  
Eurofast Connector

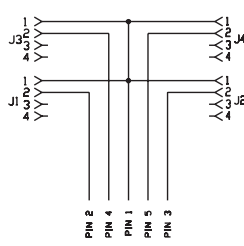

VB 40N-H1151

Isolated Circuit  
Integral Cable

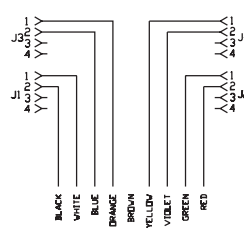

VB 4X1N-\*

Isolated Circuit  
Multifast Connector

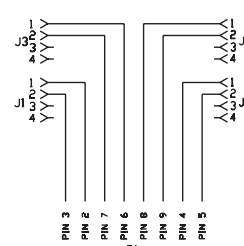

VB 4X1N-CS12



### Specifications

|                        |  |                      |  |
|------------------------|--|----------------------|--|
| <b>Housing:</b>        | Nylon  | <b>Temperature:</b>  | -40 °C to +90 °C (-40 °F to +194 °F)   |
| <b>Connectors:</b>     | Eurofast: Nylon or TPU                       | <b>Protection:</b>   | IEC IP67   |
| <b>Contacts:</b>       | Gold plated brass, machined from solid stock | <b>Accessories:</b>  | (2) VZ 3 closure caps and one VZ 1 label kit (8 labels) included                                       |
| <b>Thread Inserts:</b> | Nickel plated brass                          | <b>Cable Length:</b> | Standard length for junction boxes and Multifast® series quick disconnect cordsets is nominal 5 meters |
| <b>Cable:</b>          | See table                                    |                      |  |

### Dimensions

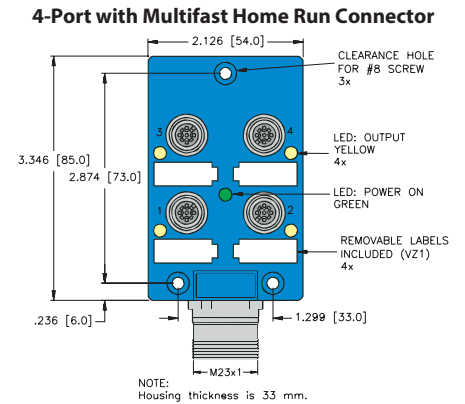
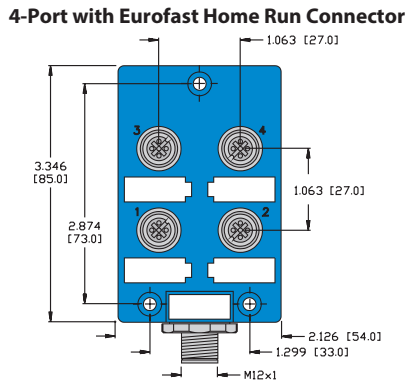
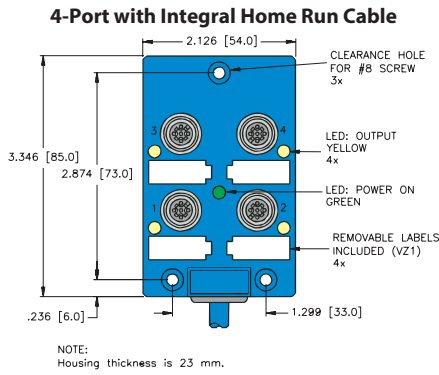

We reserve the right to make technical alterations without prior notice.

#### Notes

- Removable labels included (Part number VZ 1).
- Clearance hole for #8 screw (3 places).
- Housings with integral cable: 23 mm thickness. Housings with quick disconnect: 33 mm thickness.

#### Pinout

| 5-Pin Eurofast | 12-Pin Multifast |
|----------------|------------------|
| Female         | Male             |
|                |                  |

#### Female Pinout Diagram

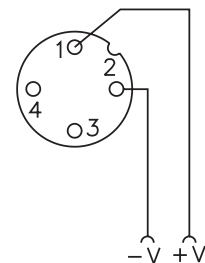

# Junction Box Connectivity Products

## Multibox® Eurofast® Junction Boxes, NAMUR, 2 Circuits per Port

- 4 Ports
- Rugged Plastic Housing with Flush Connectors
- M12 or M23 Quick Disconnect or Integral Home Run Cable
- For use with NAMUR Sensors



### 2 Circuits per Port, Common Positive, 100 VDC

| Application  | Specifications   | Pinout          |                    |                 |                    | Part Number   |
|--|--|-----------------|--------------------|-----------------|--------------------|---------------|
| 4-port J-box<br>2 circuits per port<br>Integral cable          | 4 A/port, 9 A total<br>Blue PVC cable, PLTC<br>9x22 AWG                                      | <u>Function</u> | <u>Color</u>       | <u>Function</u> | <u>Color</u>       | VB 40.5N-*    |
|  |  | V+              | BN                 | J3/Pin 2        | OG                 |               |
|  |  | J1/Pin 2        | WH                 | J3/Pin 4        | BU                 |               |
|  |  | J1/Pin 4        | BK                 | J4/Pin 2        | YE                 |               |
|  |  | J2/Pin 2        | GN                 | J4/Pin 4        | VT                 |               |
| 4-port J-box<br>2 circuits per port<br>Multifast®<br>connector | 4 A/port, 8 A total<br>12-pin Multifast connector<br>9 conductors. Mates with<br>CKNM 12-9-* | <u>Function</u> | <u>Pin / Color</u> | <u>Function</u> | <u>Pin / Color</u> | VB 40.5N-CS12 |
|  |  | V+              | 1 / BN             | J3/Pin 2        | 6 / OG             |               |
|  |  | J1/Pin 2        | 2 / WH             | J3/Pin 4        | 7 / BU             |               |
|  |  | J1/Pin 4        | 3 / BK             | J4/Pin 2        | 8 / YE             |               |
|  |  | J2/Pin 2        | 4 / GN             | J4/Pin 4        | 9 / VT             |               |

### 2 Circuits per Port, Isolated Circuits, 100 VDC

| Application  | Specifications  | Pinout          |              |                 |              | Part Number    |
|--|---|-----------------|--------------|-----------------|--------------|----------------|
| 4-port J-box<br>2 circuits per port<br>Integral cable  | 4 A/port, 9 A total<br>Blue PVC cable, PLTC<br>16x22 AWG  | <u>Function</u> | <u>Color</u> | <u>Function</u> | <u>Color</u> | VB 4X1.5N-*    |
|  |   | J1/Pin 1        | WH           | J3/Pin 1        | VT           |                |
|  |   | J1/Pin 2        | BK           | J3/Pin 2        | GY           |                |
|  |   | J1/Pin 3        | GN           | J3/Pin 3        | PK           |                |
|  |   | J1/Pin 4        | RD           | J3/Pin 4        | TN           |                |
|  |   | J2/Pin 1        | OG           | J4/Pin 1        | WH / BK      |                |
|  |   | J2/Pin 2        | BU           | J4/Pin 2        | WH / GN      |                |
|  |   | J2/Pin 3        | BN           | J4/Pin 3        | WH / RD      |                |
| 4-port J-box<br>2 circuits per port<br>Multifast cable | 4 A/port, 8 A total<br>16-pin Multifast connector<br>16 conductors. Mates with<br>CKNWM 16-16-* | <u>Function</u> | <u>Color</u> | <u>Function</u> | <u>Color</u> | VB 4X1.5N-CS16 |
|  |   | J1/Pin 1        | 1/WH         | J3/Pin 1        | 9/VT         |                |
|  |   | J1/Pin 2        | 2/BK         | J3/Pin 2        | 10/GY        |                |
|  |   | J1/Pin 3        | 3/GN         | J3/Pin 3        | 11/PK        |                |
|  |   | J1/Pin 4        | 4/RD         | J3/Pin 4        | 12/TN        |                |
|  |   | J2/Pin 1        | 5/OG         | J4/Pin 1        | 13 / WH / BK |                |
|  |   | J2/Pin 2        | 6/BU         | J4/Pin 2        | 14 / WH / GN |                |
|  |   | J2/Pin 3        | 7/BN         | J4/Pin 3        | 15 / WH / RD |                |
| J2/Pin 4   | 8/YE  | J4/Pin 4        | 16 / WH / BU |                 |              |                |

We reserve the right to make technical alterations without prior notice.

## Functional Wiring Diagrams

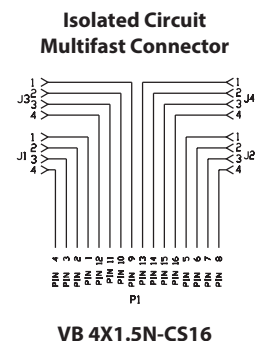
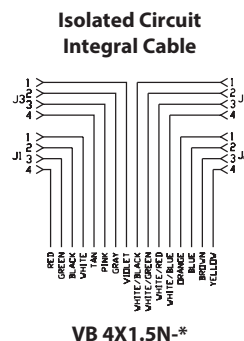
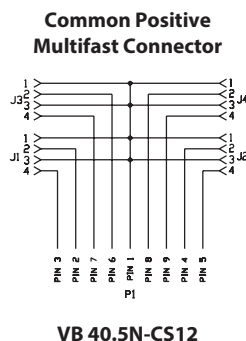
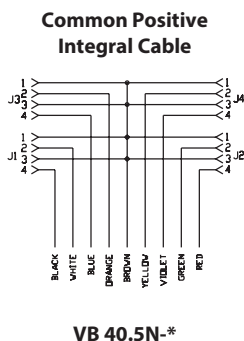

### Specifications

|                        |  |                      |  |
|------------------------|--|----------------------|--|
| <b>Housing:</b>        | Nylon  | <b>Temperature:</b>  | -40 °C to +90 °C (-40 °F to +194 °F)   |
| <b>Connectors:</b>     | Eurofast: Nylon or TPU                       | <b>Protection:</b>   | IEC IP67   |
| <b>Contacts:</b>       | Gold plated brass, machined from solid stock | <b>Accessories:</b>  | (2) VZ 3 closure caps and one VZ 1 label kit (8 labels) included                                       |
| <b>Thread Inserts:</b> | Nickel plated brass                          | <b>Cable Length:</b> | Standard length for junction boxes and Multifast® series quick disconnect cordsets is nominal 5 meters |
| <b>Cable:</b>          | See table                                    |                      |  |

### Dimensions

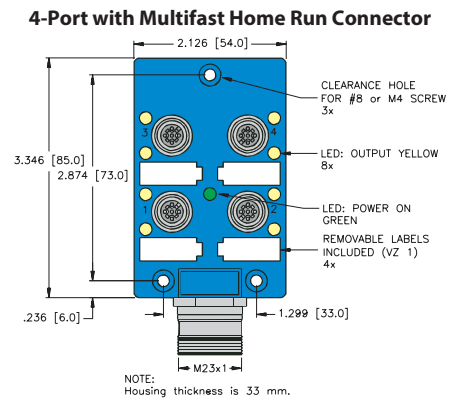
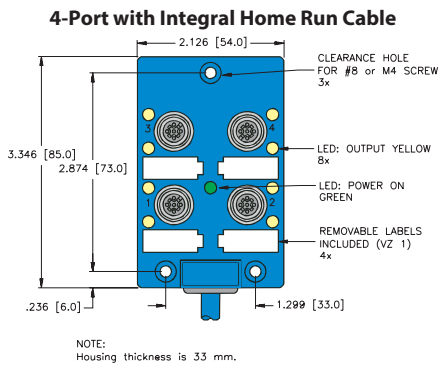

We reserve the right to make technical alterations without prior notice.

multibox®, eurofast®

#### Notes

- Removable labels included (Part number VZ 1).
- Clearance hole for #8 screw (3 places).
- Housings with integral cable: 23 mm thickness. Housings with quick disconnect: 33 mm thickness.

#### Pinout

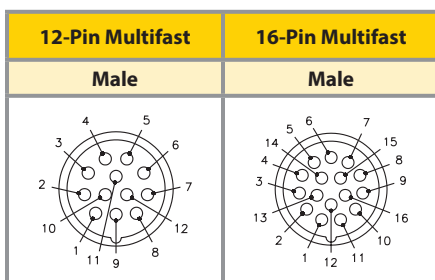

#### Female Pinout Diagram

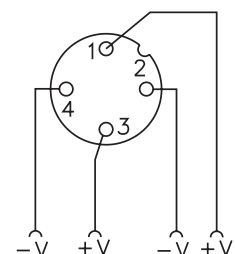

# Junction Box Connectivity Products

## Multibox® Eurofast® Terminal Chamber, 2 Signals per Port

- 4-Port, Plastic or Metal Housing
- Up to 16 A total
- Power Supply Isolation option
- Plug-in Terminal Cover with Spring Clamps or Screw Terminal



### 4-Port, 10-30 VDC, 2 Signals per Port, Isolated Power Supply Optional, Plastic Housing

#### Termination Style

| Application   | Specifications  | Pinout          |                     | Spring Clamp   | Screw Terminals |
|---|---|-----------------|---------------------|----------------|-----------------|
| 4-port J-box<br>2 signals per port<br>Jumper option for isolation between odd and even ports<br>Terminal chamber connection - spring clamp or screw terminals | 2 A/signal, 10 A total or 8 A per supply 5-pin Eurofast connector<br>2(green) power LED 2(yellow) signal per port LEDs cable diameter 5-12 mm | <u>Function</u> | <u>Terminal Pin</u> | 4MB12-5P4-K-FK | 4MB12-5P4-K-SK  |
|   |   | Port 1/Signal 1 | 1                   |                |                 |
|   |   | 2/1             | 2                   |                |                 |
|   |   | 3/1             | 3                   |                |                 |
|   |   | 4/1             | 4                   |                |                 |
|   |   | Port 1/Signal 2 | 9                   |                |                 |
|   |   | 2/2             | 10                  |                |                 |
|   |   | 3/2             | 11                  |                |                 |
|   |   | 4/2             | 12                  |                |                 |
|   |   | +V              | 17                  |                |                 |
|   |   | -V              | 18                  |                |                 |
|   |   | +V              | 19                  |                |                 |
|   |   | -V              | 20                  |                |                 |
| Ground  | PE  |                 |                     |                |                 |

### 4-Port, 10-30 VDC, 2 Signals per Port, Shielded Metal Housing

#### Termination Style

| Application  | Specifications  | Pinout          |                     | Spring Clamp | Screw Terminals |
|--|---|-----------------|---------------------|--------------|-----------------|
| 4-port J-box<br>2 signals per port<br>Termination chamber connection - spring clamp or screw terminals | 2 A/signal, 10 A total 5-pin Eurofast connector 1(green) power LED cable diameter 9-14 mm | <u>Function</u> | <u>Terminal Pin</u> | ----         | 4MB12-5P1-MS-SK |
|  |   | Port 1/Signal 1 | 1                   |              |                 |
|  |   | 2/1             | 2                   |              |                 |
|  |   | 3/1             | 3                   |              |                 |
|  |   | 4/1             | 4                   |              |                 |
|  |   | Port 1/Signal 2 | 9                   |              |                 |
|  |   | 2/2             | 10                  |              |                 |
|  |   | 3/2             | 11                  |              |                 |
|  |   | 4/2             | 12                  |              |                 |
|  |   | +V              | 17                  |              |                 |
|  |   | -V              | 18                  |              |                 |
|  |   | +V              | 19                  |              |                 |
|  |   | -V              | 20                  |              |                 |
| Ground   | PE  |                 |                     |              |                 |

We reserve the right to make technical alterations without prior notice.

## Functional Wiring Diagrams

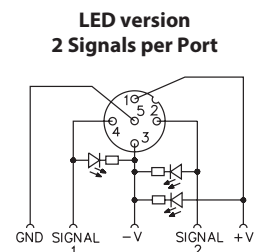
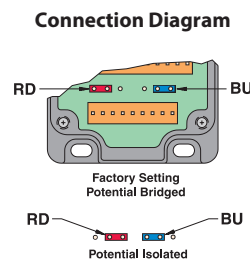
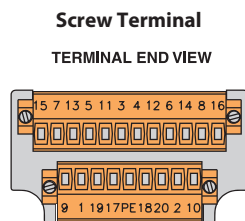
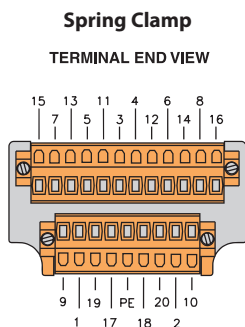

Multibox® Eurofast® Terminal Chamber, 2 Signals per Port

**Specifications**

|                              |  |                            |   |
|------------------------------|--|----------------------------|---|
| <b>Housing:</b>              | PBT Black Plastic                          | <b>Temperature:</b>        | -20 °C to +90 °C (-4 °F to +194 °F)                         |
| <b>Connectors:</b>           | Eurofast: PBT/black                        | <b>Protection:</b>         | IEC IP68  |
| <b>Contacts:</b>             | Gold plated brass                          | <b>Accessories:</b>        | (2) TC-CC closure caps and labels included                  |
| <b>Thread Inserts:</b>       | Nickel plated brass                        | <b>Termination Method:</b> | Field wireable, Spring Clamp or Screw Terminal. 16 AWG max. |
| <b>Cable Gland &amp; OD:</b> | PG 13.5, accepts cable diameter 5 to 12 mm |                            |   |
| <b>Recommended Splitter:</b> | YB2-FSM 4.5-2 FKM 4.5                      |                            |   |

**Dimensions**

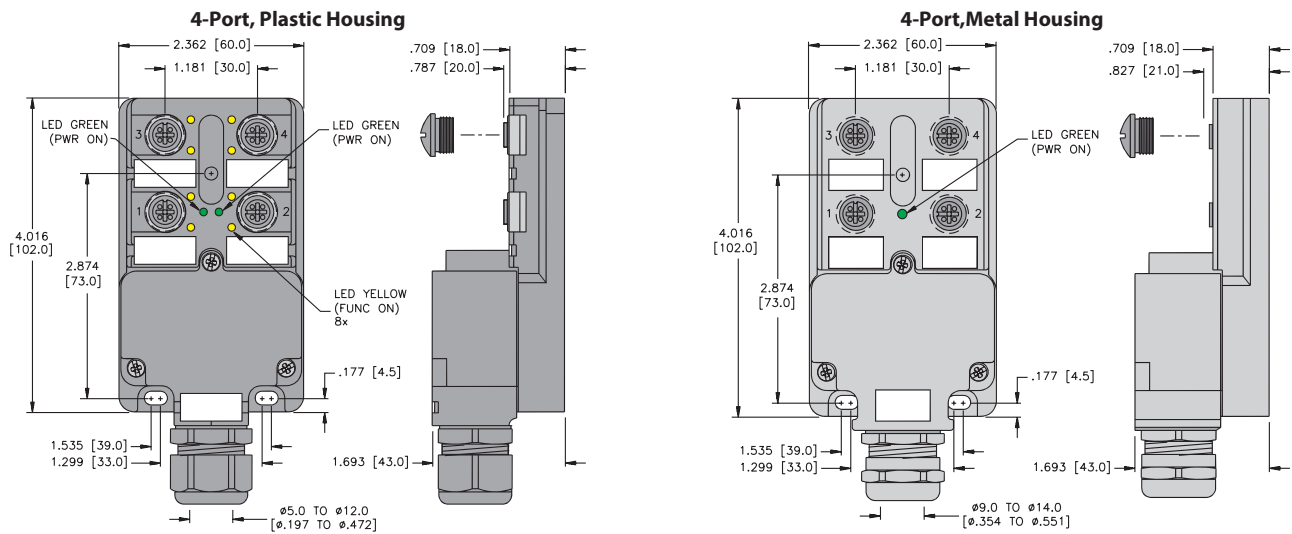

We reserve the right to make technical alterations without prior notice.

multibox®, eurofast®

**Pinout**

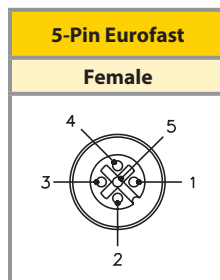

# Junction Box Connectivity Products

## Multibox® Eurofast® Terminal Chamber, 2 Signals per Port

- 8-Port Plastic or Metal Housing
- Up to 16 A total
- Power Supply Isolation option
- Plug-in Terminal Cover with Spring Clamps or Screw Terminal



### 8-Port, 10-30 VDC, 2 Signals per Port, Isolated Power Supply Optional, Plastic

### Termination Style

| Application  | Specifications   | Pinout          |              |          |              | Spring Clamp   | Screw Terminals |
|--|--|-----------------|--------------|----------|--------------|----------------|-----------------|
|  |  | Function        | Terminal Pin | Function | Terminal Pin |                |                 |
| 8-port J-box<br>2 signals per port,<br>Jumper option for<br>isolation between<br>odd and even<br>ports Terminal<br>chamber<br>connection - spring<br>clamp or screw<br>terminals | 2 A/signal, 10 A total or<br>8 A per supply<br>5-pin Eurofast connector<br>2 (green) power LED<br>2 (yellow) signal per port<br>LEDs cable diameter<br>6-12 mm | Port 1/Signal 1 | 1            | 4/2      | 12           | 8MB12-5P4-K-FK | 8MB12-5P4-K-SK  |
|  |  | 2/1             | 2            | 5/2      | 13           |                |                 |
|  |  | 3/1             | 3            | 6/2      | 14           |                |                 |
|  |  | 4/1             | 4            | 7/2      | 15           |                |                 |
|  |  | 5/1             | 5            | 8/2      | 16           |                |                 |
|  |  | 6/1             | 6            | +V       | 17           |                |                 |
|  |  | 7/1             | 7            | -V       | 18           |                |                 |
|  |  | 8/1             | 8            | +V       | 19           |                |                 |
|  |  | Port 1/Signal 2 | 9            | -V       | 20           |                |                 |
|  |  | 2/2             | 10           | Ground   | PE           |                |                 |
|  |  | 3/2             | 11           |          |              |                |                 |

### 8-Port, 10-30 VDC, 2 Signals per Port, Shielded Metal

### Termination Style

| Application   | Specifications  | Pinout          |              |          |              | Spring Clamp    | Screw Terminals |
|---|---|-----------------|--------------|----------|--------------|-----------------|-----------------|
|   |   | Function        | Terminal Pin | Function | Terminal Pin |                 |                 |
| 8-port J-box<br>2 signals per port<br>Termination<br>chamber<br>connection - spring<br>clamp or screw<br>terminal | 2 A/signal, 10 A total<br>5-pin Eurofast connector<br>1 (green) power LED<br>cable diameter 9-14 mm | Port 1/Signal 1 | 1            | 4/2      | 12           | 8MB12-5P1-MS-FK | 8MB12-5P1-MS-SK |
|   |   | 2/1             | 2            | 5/2      | 13           |                 |                 |
|   |   | 3/1             | 3            | 6/2      | 14           |                 |                 |
|   |   | 4/1             | 4            | 7/2      | 15           |                 |                 |
|   |   | 5/1             | 5            | 8/2      | 16           |                 |                 |
|   |   | 6/1             | 6            | +V       | 17           |                 |                 |
|   |   | 7/1             | 7            | -V       | 18           |                 |                 |
|   |   | 8/1             | 8            | +V       | 19           |                 |                 |
|   |   | Port 1/Signal 2 | 9            | -V       | 20           |                 |                 |
|   |   | 2/2             | 10           | Ground   | PE           |                 |                 |
|   |   | 3/2             | 11           |          |              |                 |                 |

We reserve the right to make technical alterations without prior notice.

## Functional Wiring Diagrams

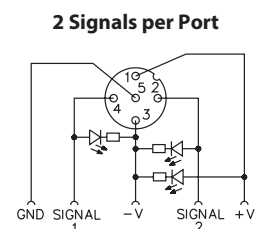
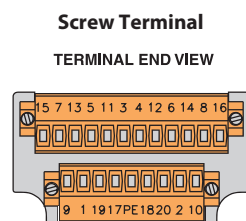
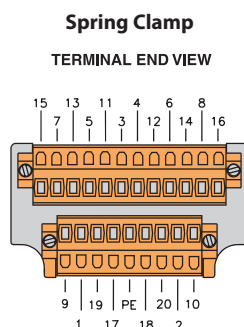

Multibox® Eurofast® Terminal Chamber, 2 Signals per Port

**Specifications**

|                              |  |                            |   |
|------------------------------|--|----------------------------|---|
| <b>Housing:</b>              | Die Cast Zinc, Nickel plated             | <b>Temperature:</b>        | -20 °C to +90 °C (-4 °F to +194 °F)                           |
| <b>Connectors:</b>           | Eurofast: PBT/black                      | <b>Protection:</b>         | IEC IP68  |
| <b>Contacts:</b>             | Gold plated brass                        | <b>Accessories:</b>        | Includes (2) TC-CC closure caps and labels                    |
| <b>Thread Inserts:</b>       | Nickel plated brass                      | <b>Termination Method:</b> | Field wireable, spring clamps or screw terminals. 16 AWG max. |
| <b>Cable Gland &amp; OD:</b> | PG 13.5, accepts cable diameter 10-14 mm |                            |   |
| <b>Recommended Splitter:</b> | YB2-FSM 4.5-2 FKM 4.5                    |                            |   |

**Dimensions**

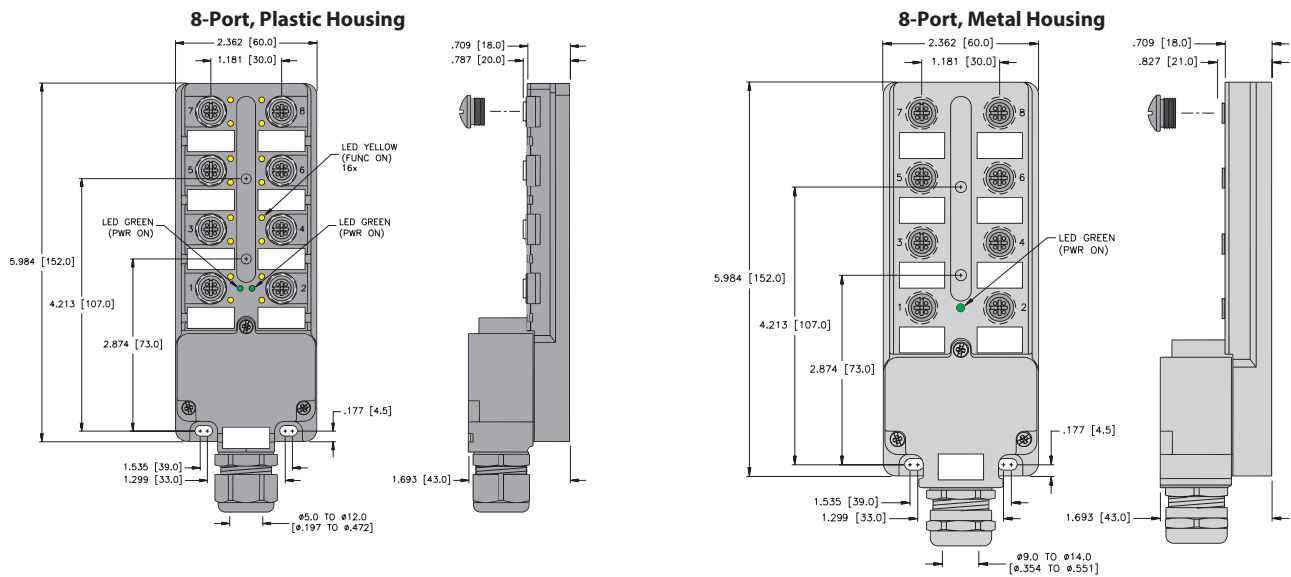

We reserve the right to make technical alterations without prior notice.

multibox®, eurofast®

**Pinout**

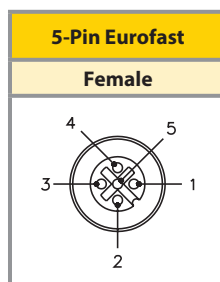

# Junction Box Connectivity Products

## Multibox® Eurofast® Junction Boxes, 4-Port, Metal

- Single Input/Output per Port
- Metal Housing with Side Connectors
- For DC Sensors and Actuators
- M23 Quick Disconnect, Minifast® Connector, or Integral Home Run Cable
- Available with or without LEDs



### 4-Port, 1 Signal per Port, 10-48 VDC

| Application   | Specifications   | Pinout  |   |   |  | Spring Clamp  | Screw Terminals    |
|---|--|---|---|---|--|---------------|--------------------|
| 4-port J-box<br>1 signal per port<br>Metal box Integral<br>cable          | 4 A/port, 10 A total<br>Yellow<br>PVC cable 7x18 AWG foil<br>shield and 20 AWG drain                     | <u>Function</u><br>+V<br>-V<br>Ground                     | <u>Color</u><br>BN<br>BU<br>GN / YE                                     | <u>Function</u><br>Port 1<br>Port 2<br>Port 3<br>Port 4 | <u>Color</u><br>WH<br>GN<br>YE<br>GY                       | VBM 40-*      | VBM 40-P7X5-*      |
| 4-port J-box<br>1 signal per port<br>Metal box<br>Multifast®<br>connector | 4 A/port, 8 A total<br>12-pin<br>Multifast connector<br>7 conductors. Mates with<br>CKM 12-7-*           | <u>Function</u><br>+V<br>-V<br>Ground                     | <u>Pin / Color</u><br>1 / BN<br>3 / BU<br>12 / GN / YE                  | <u>Function</u><br>Port 1<br>Port 2<br>Port 3<br>Port 4 | <u>Pin / Color</u><br>4 / WH<br>6 / GN<br>7 / YE<br>8 / GY | VBM 40-CS12   | VBM 40-P7X5-CS12   |
| 4-port J-box<br>1 signal per port,<br>Metal box Minifast<br>connector     | 4 A/port, 7 A total<br>12-pin Minifast connector<br>7 conductors. Mates with<br>RKM 126-*M CSA Certified | <u>Function</u><br>+V<br>-V<br>Ground<br>Port 1<br>Port 2 | <u>Pin / Color</u><br>10 / RD<br>11 / WH<br>12 / BK<br>1 / OG<br>2 / BU | <u>Function</u><br>Port 3<br>Port 4                     | <u>Pin / Color</u><br>3 / WH/BK<br>4 / RD/BK               | VBM 40-RSF120 | VBM 40-P7X5-RSF120 |

We reserve the right to make technical alterations without prior notice.

### Functional Wiring Diagrams

(No LED Version)  
1 Signal per Port

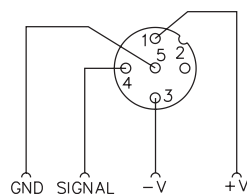

(PNP LED Version)  
1 Signal per Port

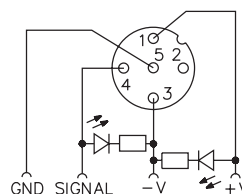



### Specifications

|                        |                         |                      |   |
|------------------------|-------------------------|----------------------|---|
| <b>Housing:</b>        | Die-cast aluminum alloy | <b>Temperature:</b>  | -40 °C to +90 °C (-40 °F to +194 °F)  |
| <b>Connectors:</b>     | Eurofast: Nylon or TPU  | <b>Protection:</b>   | IEC IP67  |
| <b>Contacts:</b>       | Gold plated brass       | <b>Accessories:</b>  | (2) VZ 3 closure caps included  |
| <b>Thread Inserts:</b> | Nickel plated brass     | <b>Cable Length:</b> | Standard length for junction boxes and Multifast® series quick disconnect cordsets is nominal 5 meters<br>Other lengths available by request. Consult factory |
| <b>Cable:</b>          | See table               |                      |   |

### Dimensions

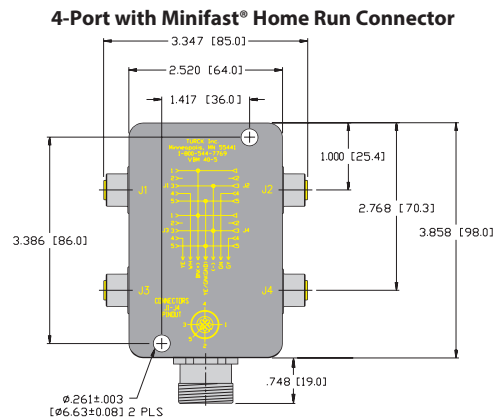
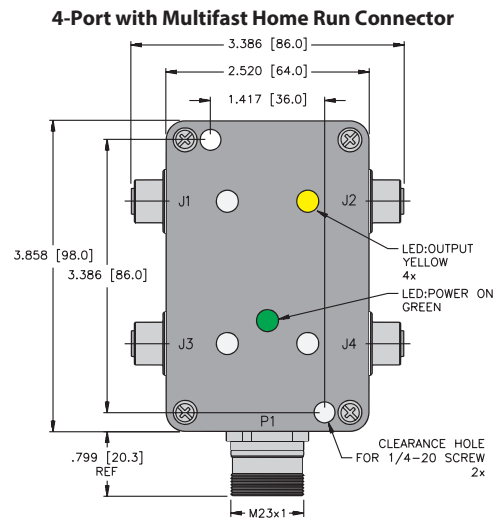
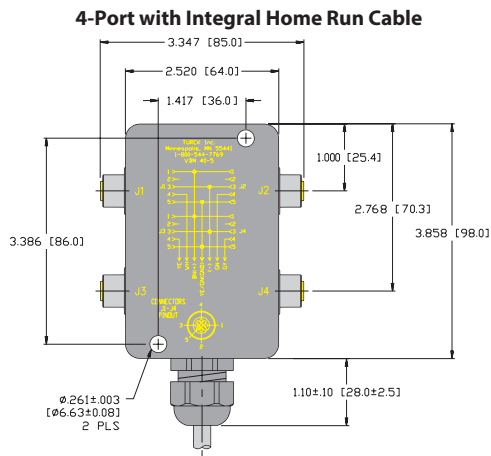

We reserve the right to make technical alterations without prior notice.

#### Notes

1. For mating CKM cordsets. See Multifast pages.
2. For mating RKM cordsets. See Minifast pages.

#### Pinout

| 5-Pin Eurofast | 12-Pin Multifast | 12-pin Minifast |
|----------------|------------------|-----------------|
| Female         | Male             | Male            |
|                |                  |                 |

multibox®, eurofast®

# Junction Box Connectivity Products

## Multibox® Eurofast® Junction Boxes, 8-Port, Metal

- Single Input/Output per Port
- Metal Housing with Side Connectors
- For DC Sensors and Actuators
- M23 Quick Disconnect, Minifast Connector, or Integral Home Run Cable
- Available with or without LEDs



### 8-Port, 1 Signal per Port, 10-48 VDC

| Application   | Specifications  | Pinout  |  |   |  | Spring Clamp  | Screw Terminals    |
|---|---|---|--|---|--|---------------|--------------------|
| 8-port J-box<br>1 signal per port<br>Metal box Integral<br>cable          | 4 A/port, 10 A total<br>Yellow PVC cable<br>11x18 AWG, foil shield and<br>20 AWG drain                  | <u>Function</u><br>+V<br>-V<br>Ground<br>Port 1<br>Port 2<br>Port 3 | <u>Color</u><br>BN<br>BU<br>GN / YE<br>WH<br>GN<br>YE                              | <u>Function</u><br>Port 4<br>Port 5<br>Port 6<br>Port 7<br>Port 8           | <u>Color</u><br>GY<br>PK<br>RD<br>BK<br>VT   | VBM 80-*      | VBM 80-P7X9-*      |
| 8-port J-box<br>1 signal per port<br>Metal box<br>Multifast®<br>connector | 4 A/port, 8 A total<br>12-pin Multifast connector<br>9 conductors. Mates with<br>CKM 12-11-*            | <u>Function</u><br>+V<br>-V<br>Ground<br>Port 1<br>Port 2<br>Port 3 | <u>Pin / Color</u><br>1 / BN<br>3 / BU<br>12 / GN/YE<br>4 / WH<br>5 / GN<br>6 / YE | <u>Function</u><br>Port 4<br>Port 5<br>Port 6<br>Port 7<br>Port 8           | <u>Pin / Color</u><br>7 / GY<br>8 / PK<br>9 / RD<br>10 / BK<br>11 / VT                           | VBM 80-CS12   | VBM 80-P7X9-CS12   |
| 8-port J-box<br>1 signal per port<br>Metal box Minifast<br>connector      | 4 A/port, 7 A total<br>12-pin Minifast connector<br>9 conductors. Mates with<br>RKM 126-* CSA Certified | <u>Function</u><br>+V<br>-V<br>Ground<br>Port 1<br>Port 2           | <u>Pin / Color</u><br>10 / RD<br>11 / WH<br>12 / BK<br>1 / OG<br>2 / BU            | <u>Function</u><br>Port 3<br>Port 4<br>Port 5<br>Port 6<br>Port 7<br>Port 8 | <u>Pin / Color</u><br>3 / WH/BK<br>4 / RD/BK<br>5 / GN/BK<br>6 / OG/BK<br>7 / BU/BK<br>8 / BK/WH | VBM 80-RSF120 | VBM 80-P7X9-RSF120 |

We reserve the right to make technical alterations without prior notice.

### Functional Wiring Diagrams

(No LED Version)  
1 Signal per Port

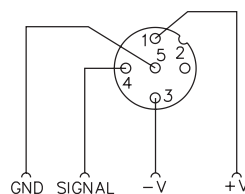

(PNP LED Version)  
1 Signal per Port

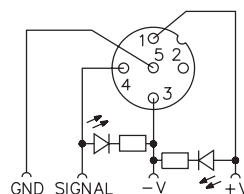

### Specifications

|                        |                         |                      |   |
|------------------------|-------------------------|----------------------|---|
| <b>Housing:</b>        | Die-cast aluminum alloy | <b>Temperature:</b>  | -40 °C to +90 °C (-40 °F to +194 °F)  |
| <b>Connectors:</b>     | Eurofast: Nylon or TPU  | <b>Protection:</b>   | IEC IP67  |
| <b>Contacts:</b>       | Gold plated brass       | <b>Accessories:</b>  | (2) VZ 3 closure caps included  |
| <b>Thread Inserts:</b> | Nickel plated brass     | <b>Cable Length:</b> | Standard length for junction boxes and Multifast® series quick disconnect cordsets is nominal 5 meters<br>Other lengths available by request. Consult factory |
| <b>Cable:</b>          | See table               |                      |   |

### Dimensions

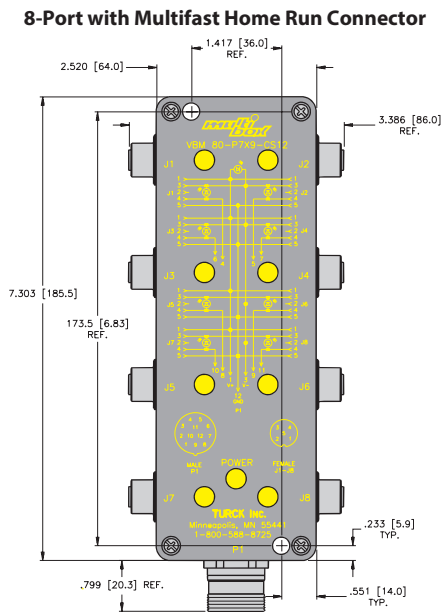
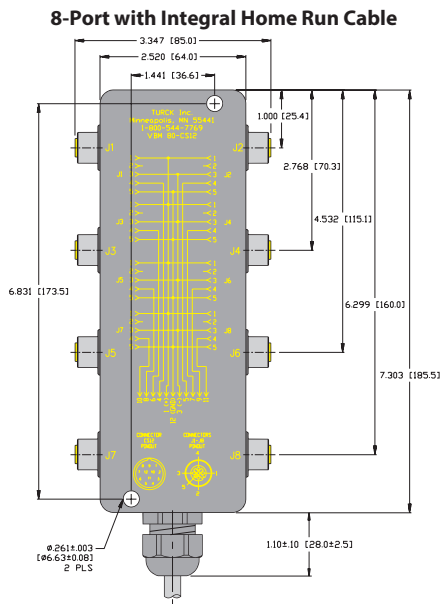

**8-Port with Minifast® Home Run Connector**

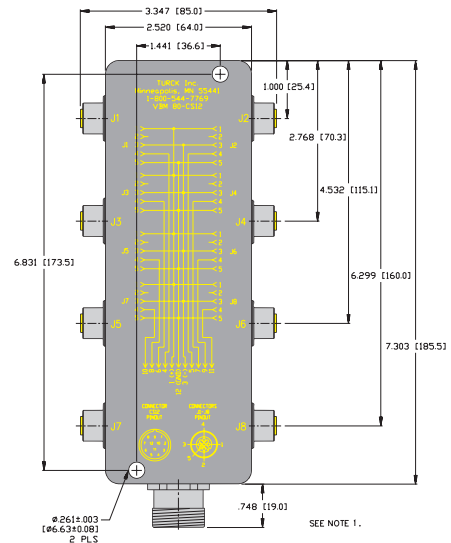

We reserve the right to make technical alterations without prior notice.

#### Notes

1. For mating CKM cordsets. See Multifast pages.
2. For mating RKM cordsets. See Minifast pages.

#### Pinout

| 5-Pin Eurofast | 12-Pin Multifast | 12-pin Minifast |
|----------------|------------------|-----------------|
| Female         | Male             | Male            |
|                |                  |                 |

multibox®, eurofast®

# Junction Box Connectivity Products

## Multibox® Eurofast® Junction Box, 16-Port

- Single Input/ Output per Port
- Rugged Plastic Housing with Flush Connectors
- Quick Disconnect
- Available with LEDs



### 16-Port, 1-Signal per Port, 10-48 VDC

| Application   | Specifications   | Pinout          |                    |                 |                    | PNP LED         |
|---|--|-----------------|--------------------|-----------------|--------------------|-----------------|
| 16-port J-box<br>1 signal per port<br>Multifast®<br>connector | 4 A/port, 8 A total<br>12-pin Multifast connector.<br>Mates with CKM 19-19-*.<br>CSA Certified | <u>Function</u> | <u>Pin / Color</u> | <u>Function</u> | <u>Pin / Color</u> | 16MB12-4P2-CS19 |
|   |  | +V              | 19 / BN            | Port 7          | 3 / GY             |                 |
|   |  | -V              | 6 / BU             | Port 8          | 14 / BN / GN       |                 |
|   |  | Ground          | 12 / GN / YE       | Port 9          | 17 / PK            |                 |
|   |  | Port 1          | 15 / WH            | Port 10         | 9 / WH / YE        |                 |
|   |  | Port 2          | 7 / GY / PK        | Port 11         | 2 / RD             |                 |
|   |  | Port 3          | 5 / GN             | Port 12         | 13 / YE / BN       |                 |
|   |  | Port 4          | 4 / RD / BU        | Port 13         | 11 / BK            |                 |
|   |  | Port 5          | 16 / YE            | Port 14         | 10 / WH / GY       |                 |
|   |  | Port 6          | 8 / WH / GN        | Port 15         | 1 / VT             |                 |
|   |  |                 |                    | Port 16         | 18 / GY / BN       |                 |

We reserve the right to make technical alterations without prior notice.

## Functional Wiring Diagrams

(PNP LED Version)  
1 Signal per Port

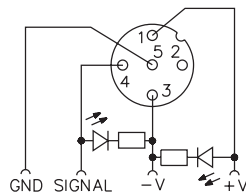

## Multibox® Eurofast® Junction Box, 16-Port

### Specifications

|                        |   |                      |   |
|------------------------|---|----------------------|---|
| <b>Housing:</b>        | Nylon                                     | <b>Temperature:</b>  | -30 °C to +80 °C (-22 °F to +176 °F)  |
| <b>Connectors:</b>     | Nylon/BK (1,1A-8,8A), Nitrile/Yellow (P1) | <b>Protection:</b>   | IEC IP67  |
| <b>Contacts:</b>       | Gold plated brass                         | <b>Accessories:</b>  | Includes (2) VZ 3 closure caps and a VZ 1 label kit (16 labels) included                    |
| <b>Thread Inserts:</b> | Nickel plated brass                       | <b>Cable Length:</b> | Standard length is nominal 5 meters. Other lengths available upon request - Consult factory |

### Dimensions

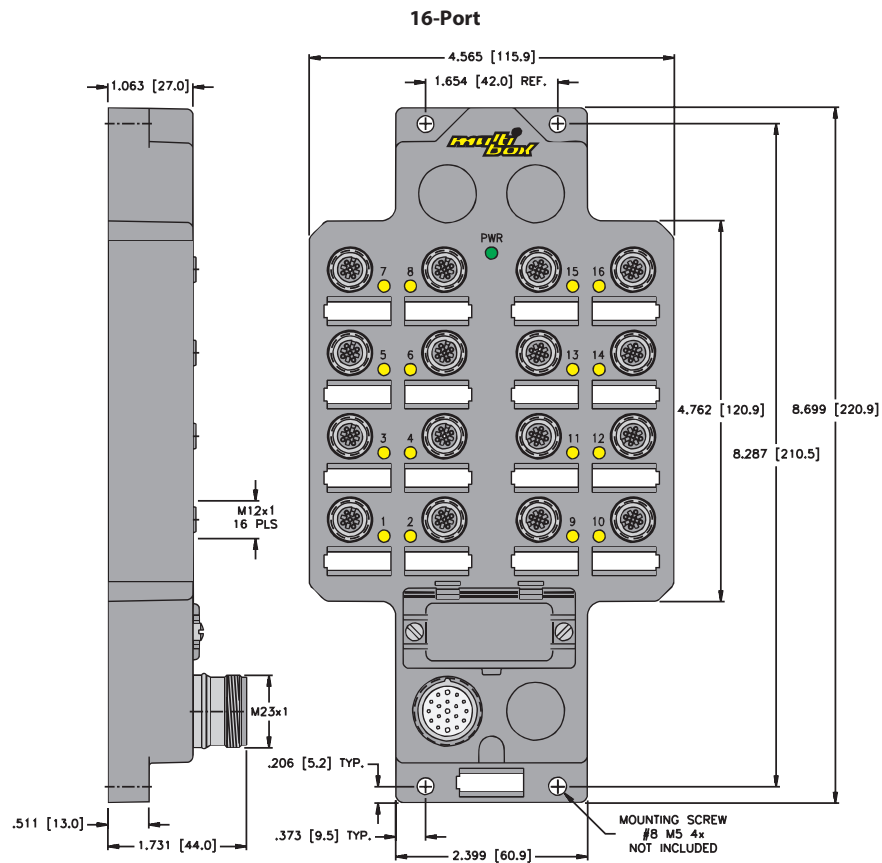

We reserve the right to make technical alterations without prior notice.

multibox®, eurofast®

### Pinout

| 5-Pin Eurofast | 19-pin Multifast® |
|----------------|-------------------|
| Female         | Male              |
|                |                   |

# Junction Box Connectivity Products

## Multibox® Eurofast® AC/DC Junction Box, 4-Port

- 4 Ports for connecting DC sensors
- Integrated DC power supply
- Solid-State AC output from DC sensors
- LED shows power supply function
- Home Run wiring matches standard AC style junction boxes for easy installation



### 4-Port, 85-132 VAC

| Application                                    | Specifications  | Pinout   | Part Number |           |              |        |       |             |        |        |              |        |              |        |              |        |              |        |                                 |
|--|---|--|-------------|-----------|--------------|--------|-------|-------------|--------|--------|--------------|--------|--------------|--------|--------------|--------|--------------|--------|---------------------------------|
| 4-port J-box for DC sensors in AC applications | 85 - 132 VAC input 24 VDC output to sensors 100 mA output per port<br>7-pin Minifast® connector. Mates with RKM 76-*M | <table border="1"> <thead> <tr> <th>Function</th> <th>Pin/Color</th> </tr> </thead> <tbody> <tr> <td>L1 AC Common</td> <td>3 / WH</td> </tr> <tr> <td>L2 AC</td> <td>1 / WH / BK</td> </tr> <tr> <td>Ground</td> <td>7 / GN</td> </tr> <tr> <td>J1 Load (L2)</td> <td>2 / BK</td> </tr> <tr> <td>J2 Load (L2)</td> <td>4 / RD</td> </tr> <tr> <td>J3 Load (L2)</td> <td>5 / OG</td> </tr> <tr> <td>J4 Load (L2)</td> <td>6 / BU</td> </tr> </tbody> </table> | Function    | Pin/Color | L1 AC Common | 3 / WH | L2 AC | 1 / WH / BK | Ground | 7 / GN | J1 Load (L2) | 2 / BK | J2 Load (L2) | 4 / RD | J3 Load (L2) | 5 / OG | J4 Load (L2) | 6 / BU | VBM-AC/DC/AC-RSM 70/ADAPTER BOX |
| Function                                       | Pin/Color   |  |             |           |              |        |       |             |        |        |              |        |              |        |              |        |              |        |                                 |
| L1 AC Common                                   | 3 / WH  |  |             |           |              |        |       |             |        |        |              |        |              |        |              |        |              |        |                                 |
| L2 AC  | 1 / WH / BK   |  |             |           |              |        |       |             |        |        |              |        |              |        |              |        |              |        |                                 |
| Ground   | 7 / GN  |  |             |           |              |        |       |             |        |        |              |        |              |        |              |        |              |        |                                 |
| J1 Load (L2)                                   | 2 / BK  |  |             |           |              |        |       |             |        |        |              |        |              |        |              |        |              |        |                                 |
| J2 Load (L2)                                   | 4 / RD  |  |             |           |              |        |       |             |        |        |              |        |              |        |              |        |              |        |                                 |
| J3 Load (L2)                                   | 5 / OG  |  |             |           |              |        |       |             |        |        |              |        |              |        |              |        |              |        |                                 |
| J4 Load (L2)                                   | 6 / BU  |  |             |           |              |        |       |             |        |        |              |        |              |        |              |        |              |        |                                 |

We reserve the right to make technical alterations without prior notice.

### Functional Wiring Diagrams

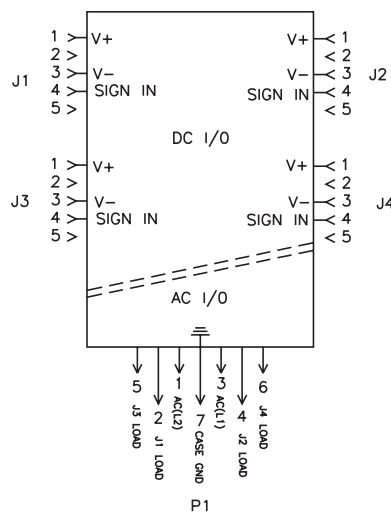

## Multibox® Eurofast® AC/DC Junction Box, 4-Port

### Specifications

|                         |  |                     |                                      |
|-------------------------|--|---------------------|--------------------------------------|
| <b>Housing:</b>         | Die cast aluminum alloy                | <b>Temperature:</b> | -30 °C to +70 °C (-22 °C to +158 °F) |
| <b>Contact Carrier:</b> | Eurofast: Nylon or TPU. Minifast®: TPU | <b>Protection:</b>  | IEC IP67                             |
| <b>Contacts:</b>        | Gold plated brass                      | <b>Accessories:</b> | VZ 3 Closure Caps (2 included)       |
| <b>Thread Inserts:</b>  | Nickel plated brass                    |                     |                                      |

### Dimensions

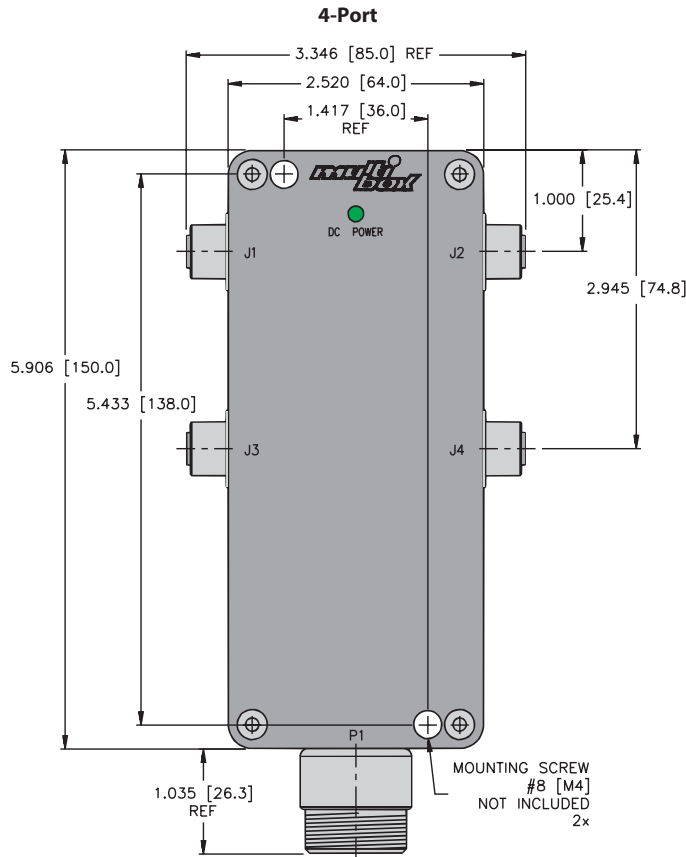

We reserve the right to make technical alterations without prior notice.

multibox®, eurofast®

### Pinout

| 5-Pin Eurofast | 7-pin Minifast® |
|----------------|-----------------|
| Female         | Male            |
|                |                 |

# Junction Box Connectivity Products

## Multibox® Picofast® Junction Boxes, 4-Port, 3-Pin

- Snap Lock or Threaded Connectors
- Available with or without LEDs
- M12 Quick Disconnect or Integral Home Run Cable



### 4-Port, Snap Lock, 10-48 VDC

| Application   | Specifications   | Pinout  | No LEDs         | PNP LED      |    |    |    |    |        |    |        |    |        |    |        |    |              |                  |
|---|--|---|-----------------|--------------|----|----|----|----|--------|----|--------|----|--------|----|--------|----|--------------|------------------|
| 4-port J-box Snap lock connectors Top Integral cable                    | 3 A/port, 3 A total<br>Black PVC<br>6x24 AWG   | <table border="0"> <tr> <td><u>Function</u></td> <td><u>Color</u></td> </tr> <tr> <td>+V</td> <td>BN</td> </tr> <tr> <td>-V</td> <td>BU</td> </tr> <tr> <td>Port 1</td> <td>WH</td> </tr> <tr> <td>Port 2</td> <td>GN</td> </tr> <tr> <td>Port 3</td> <td>YE</td> </tr> <tr> <td>Port 4</td> <td>GY</td> </tr> </table> | <u>Function</u> | <u>Color</u> | +V | BN | -V | BU | Port 1 | WH | Port 2 | GN | Port 3 | YE | Port 4 | GY | VB 403Z-*    | VB 403Z-PX5-*    |
| <u>Function</u>   | <u>Color</u>   |   |                 |              |    |    |    |    |        |    |        |    |        |    |        |    |              |                  |
| +V  | BN   |   |                 |              |    |    |    |    |        |    |        |    |        |    |        |    |              |                  |
| -V  | BU   |   |                 |              |    |    |    |    |        |    |        |    |        |    |        |    |              |                  |
| Port 1  | WH   |   |                 |              |    |    |    |    |        |    |        |    |        |    |        |    |              |                  |
| Port 2  | GN   |   |                 |              |    |    |    |    |        |    |        |    |        |    |        |    |              |                  |
| Port 3  | YE   |   |                 |              |    |    |    |    |        |    |        |    |        |    |        |    |              |                  |
| Port 4  | GY   |   |                 |              |    |    |    |    |        |    |        |    |        |    |        |    |              |                  |
| 4-port J-box 1 signal per port Snap lock connectors Side Integral cable | 3 A/port, 4 A total<br>Black PVC cable<br>6x24 AWG                                     | <table border="0"> <tr> <td><u>Function</u></td> <td><u>Color</u></td> </tr> <tr> <td>+V</td> <td>BN</td> </tr> <tr> <td>-V</td> <td>BU</td> </tr> <tr> <td>Port 1</td> <td>WH</td> </tr> <tr> <td>Port 2</td> <td>GN</td> </tr> <tr> <td>Port 3</td> <td>YE</td> </tr> <tr> <td>Port 4</td> <td>GY</td> </tr> </table> | <u>Function</u> | <u>Color</u> | +V | BN | -V | BU | Port 1 | WH | Port 2 | GN | Port 3 | YE | Port 4 | GY | VB 403Z-*C   | VB 403Z-PX5-*C   |
| <u>Function</u>   | <u>Color</u>   |   |                 |              |    |    |    |    |        |    |        |    |        |    |        |    |              |                  |
| +V  | BN   |   |                 |              |    |    |    |    |        |    |        |    |        |    |        |    |              |                  |
| -V  | BU   |   |                 |              |    |    |    |    |        |    |        |    |        |    |        |    |              |                  |
| Port 1  | WH   |   |                 |              |    |    |    |    |        |    |        |    |        |    |        |    |              |                  |
| Port 2  | GN   |   |                 |              |    |    |    |    |        |    |        |    |        |    |        |    |              |                  |
| Port 3  | YE   |   |                 |              |    |    |    |    |        |    |        |    |        |    |        |    |              |                  |
| Port 4  | GY   |   |                 |              |    |    |    |    |        |    |        |    |        |    |        |    |              |                  |
| 4-port J-box Snap lock connectors Eurofast® connector                   | 3 A/port, 3 A total<br>8-pin Eurofast connector<br>6 conductors. Mates with RKC 8.6T-* | <table border="0"> <tr> <td><u>Function</u></td> <td><u>Pin</u></td> </tr> <tr> <td>+V</td> <td>5</td> </tr> <tr> <td>-V</td> <td>7</td> </tr> <tr> <td>Port 1</td> <td>1</td> </tr> <tr> <td>Port 2</td> <td>2</td> </tr> <tr> <td>Port 3</td> <td>3</td> </tr> <tr> <td>Port 4</td> <td>4</td> </tr> </table>         | <u>Function</u> | <u>Pin</u>   | +V | 5  | -V | 7  | Port 1 | 1  | Port 2 | 2  | Port 3 | 3  | Port 4 | 4  | VB 403Z-FS 8 | VB 403Z-PX5-FS 8 |
| <u>Function</u>   | <u>Pin</u>   |   |                 |              |    |    |    |    |        |    |        |    |        |    |        |    |              |                  |
| +V  | 5  |   |                 |              |    |    |    |    |        |    |        |    |        |    |        |    |              |                  |
| -V  | 7  |   |                 |              |    |    |    |    |        |    |        |    |        |    |        |    |              |                  |
| Port 1  | 1  |   |                 |              |    |    |    |    |        |    |        |    |        |    |        |    |              |                  |
| Port 2  | 2  |   |                 |              |    |    |    |    |        |    |        |    |        |    |        |    |              |                  |
| Port 3  | 3  |   |                 |              |    |    |    |    |        |    |        |    |        |    |        |    |              |                  |
| Port 4  | 4  |   |                 |              |    |    |    |    |        |    |        |    |        |    |        |    |              |                  |

### 4-Port, Threaded, 10-48 VDC

| Application  | Specifications   | Pinout  | No LEDs         | PNP LED      |    |    |    |    |        |    |        |    |        |    |        |    |              |                  |
|--|--|---|-----------------|--------------|----|----|----|----|--------|----|--------|----|--------|----|--------|----|--------------|------------------|
| 4-port J-box Threaded connectors Top Integral connector                | 3 A/port, 3 A total<br>Black PVC<br>6x24 AWG   | <table border="0"> <tr> <td><u>Function</u></td> <td><u>Color</u></td> </tr> <tr> <td>+V</td> <td>BN</td> </tr> <tr> <td>-V</td> <td>BU</td> </tr> <tr> <td>Port 1</td> <td>WH</td> </tr> <tr> <td>Port 2</td> <td>GN</td> </tr> <tr> <td>Port 3</td> <td>YE</td> </tr> <tr> <td>Port 4</td> <td>GY</td> </tr> </table> | <u>Function</u> | <u>Color</u> | +V | BN | -V | BU | Port 1 | WH | Port 2 | GN | Port 3 | YE | Port 4 | GY | VB 403M-*    | VB 403M-PX5-*    |
| <u>Function</u>  | <u>Color</u>   |   |                 |              |    |    |    |    |        |    |        |    |        |    |        |    |              |                  |
| +V   | BN   |   |                 |              |    |    |    |    |        |    |        |    |        |    |        |    |              |                  |
| -V   | BU   |   |                 |              |    |    |    |    |        |    |        |    |        |    |        |    |              |                  |
| Port 1   | WH   |   |                 |              |    |    |    |    |        |    |        |    |        |    |        |    |              |                  |
| Port 2   | GN   |   |                 |              |    |    |    |    |        |    |        |    |        |    |        |    |              |                  |
| Port 3   | YE   |   |                 |              |    |    |    |    |        |    |        |    |        |    |        |    |              |                  |
| Port 4   | GY   |   |                 |              |    |    |    |    |        |    |        |    |        |    |        |    |              |                  |
| 4-port J-box 1 signal per port Threaded conductors Side Integral cable | 3 A/port, 4 A total<br>Black PVC cable<br>6x24 AWG                                     | <table border="0"> <tr> <td><u>Function</u></td> <td><u>Color</u></td> </tr> <tr> <td>+V</td> <td>BN</td> </tr> <tr> <td>-V</td> <td>BU</td> </tr> <tr> <td>Port 1</td> <td>WH</td> </tr> <tr> <td>Port 2</td> <td>GN</td> </tr> <tr> <td>Port 3</td> <td>YE</td> </tr> <tr> <td>Port 4</td> <td>GY</td> </tr> </table> | <u>Function</u> | <u>Color</u> | +V | BN | -V | BU | Port 1 | WH | Port 2 | GN | Port 3 | YE | Port 4 | GY | VB 403M-*C   | VB 403M-PX5-*C   |
| <u>Function</u>  | <u>Color</u>   |   |                 |              |    |    |    |    |        |    |        |    |        |    |        |    |              |                  |
| +V   | BN   |   |                 |              |    |    |    |    |        |    |        |    |        |    |        |    |              |                  |
| -V   | BU   |   |                 |              |    |    |    |    |        |    |        |    |        |    |        |    |              |                  |
| Port 1   | WH   |   |                 |              |    |    |    |    |        |    |        |    |        |    |        |    |              |                  |
| Port 2   | GN   |   |                 |              |    |    |    |    |        |    |        |    |        |    |        |    |              |                  |
| Port 3   | YE   |   |                 |              |    |    |    |    |        |    |        |    |        |    |        |    |              |                  |
| Port 4   | GY   |   |                 |              |    |    |    |    |        |    |        |    |        |    |        |    |              |                  |
| 4-port J-box Threaded connectors Eurofast connector                    | 3 A/port, 3 A total<br>8-pin Eurofast connector<br>6 conductors. Mates with RKC 8.6T-* | <table border="0"> <tr> <td><u>Function</u></td> <td><u>Pin</u></td> </tr> <tr> <td>+V</td> <td>5</td> </tr> <tr> <td>-V</td> <td>7</td> </tr> <tr> <td>Port 1</td> <td>1</td> </tr> <tr> <td>Port 2</td> <td>2</td> </tr> <tr> <td>Port 3</td> <td>3</td> </tr> <tr> <td>Port 4</td> <td>4</td> </tr> </table>         | <u>Function</u> | <u>Pin</u>   | +V | 5  | -V | 7  | Port 1 | 1  | Port 2 | 2  | Port 3 | 3  | Port 4 | 4  | VB 403M-FS 8 | VB 403M-PX5-FS 8 |
| <u>Function</u>  | <u>Pin</u>   |   |                 |              |    |    |    |    |        |    |        |    |        |    |        |    |              |                  |
| +V   | 5  |   |                 |              |    |    |    |    |        |    |        |    |        |    |        |    |              |                  |
| -V   | 7  |   |                 |              |    |    |    |    |        |    |        |    |        |    |        |    |              |                  |
| Port 1   | 1  |   |                 |              |    |    |    |    |        |    |        |    |        |    |        |    |              |                  |
| Port 2   | 2  |   |                 |              |    |    |    |    |        |    |        |    |        |    |        |    |              |                  |
| Port 3   | 3  |   |                 |              |    |    |    |    |        |    |        |    |        |    |        |    |              |                  |
| Port 4   | 4  |   |                 |              |    |    |    |    |        |    |        |    |        |    |        |    |              |                  |

We reserve the right to make technical alterations without prior notice.

### Functional Wiring Diagrams

No LED Version

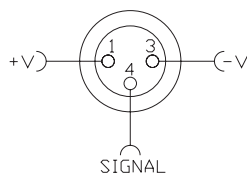

LED Version

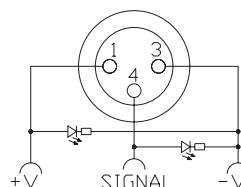



## Multibox® Picofast® Junction Boxes, 4-Port, 3-Pin

### Specifications

|   |  |
|---|--|
| <b>Housing:</b> Nylon   | <b>Temperature:</b> -30 °C to +80 °C (-22 °F to +176 °F)   |
| <b>Connectors:</b> TPU (Picofast); nylon or TPU (Eurofast®); PETP (M16) | <b>Protection:</b> IEC IP67  |
| <b>Contacts:</b> Gold plated brass                                      | <b>Accessories:</b> KS 5/10 labels, 2 pieces PSG-CC (snap lock) or PSGM-CC (threaded) included                   |
| <b>Thread Inserts:</b> Nickel plated brass                              | <b>Cable Length:</b> Standard length is nominal 5 meters<br>Other lengths available by request - Consult factory |
| <b>Cable:</b> See table   |  |

### Dimensions

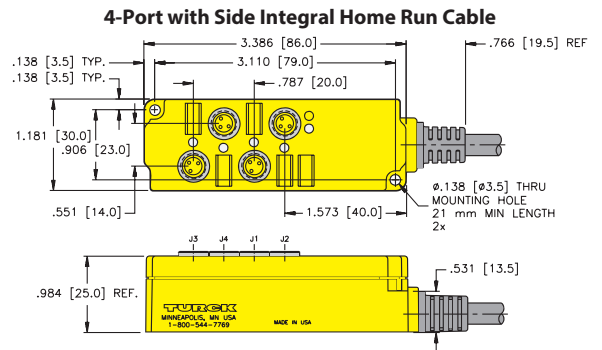
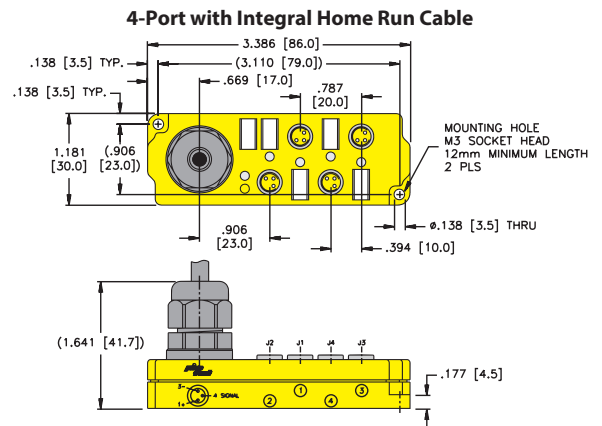
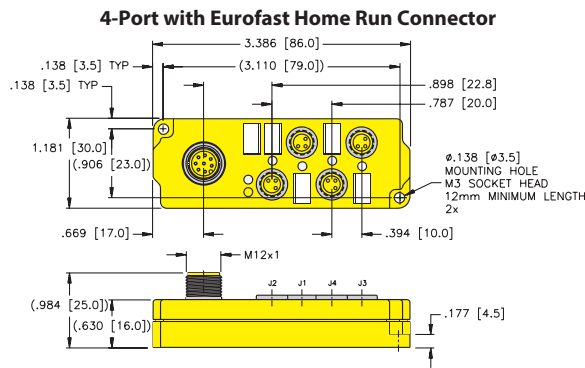

We reserve the right to make technical alterations without prior notice.

multibox®, picofast®

### Pinout

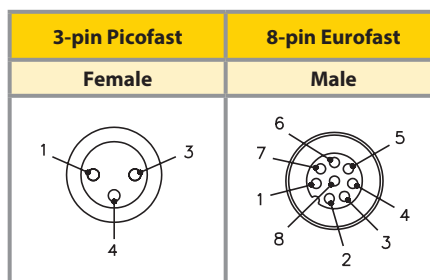

# Junction Box Connectivity Products

## Multibox® Picofast® Junction Boxes, 8-Port, 3-Pin

- Snap Lock or Threaded Connectors
- Available with or without LEDs
- M16 Quick Disconnect or Integral Home Run Cable



### 8-Port, Snap Lock, 10-48 VDC

| Application  | Specifications   | Pinout  |  |   |  | No LEDs      | PNP LED          |
|--|--|---|--|---|--|--------------|------------------|
| 8-port J-box<br>Snap lock connectors<br>Top Integral cable                       | 3 A/port, 3 A total<br>Black PVC cable 10x24 AWG   | <u>Function</u><br>+V<br>-V<br>Port 1<br>Port 2<br>Port 3 | <u>Color</u><br>BN<br>BU<br>WH<br>GN<br>YE                 | <u>Function</u><br>Port 4<br>Port 5<br>Port 6<br>Port 7<br>Port 8 | <u>Color</u><br>GY<br>PK<br>RD<br>BK<br>VT                 | VB 803Z-*    | VB 803Z-PX9-*    |
| 8-port J-box<br>1 signal per port<br>Snap lock connectors<br>Side Integral cable | 3 A/port, 4 A total<br>Black PVC cable 10x24 AWG   |   |  |   |  | VB 803Z-*C   | VB 803Z-PX9*C    |
| 8-port J-box,<br>Snap lock connectors<br>M16 connector                           | 3 A/port, 3 A total<br>14 pin M16 connector<br>10 conductors. Mates<br>with BKM 14-836-* | <u>Function</u><br>+V<br>-V<br>Port 1<br>Port 2<br>Port 3 | <u>Pin / Color</u><br>M/BN<br>U/BU<br>P/WH<br>E/GN<br>O/YE | <u>Function</u><br>Port 4<br>Port 5<br>Port 6<br>Port 7<br>Port 8 | <u>Pin / Color</u><br>C/GY<br>N/PK<br>R/RD<br>G/BK<br>S/VT | VB 803Z-BS14 | VB 803Z-PX9-BS14 |

### 8-Port, Threaded, 10-48 VDC

| Application   | Specifications   | Pinout  |  |   |  | No LEDs      | PNP LED          |
|---|--|---|--|---|--|--------------|------------------|
| 8-port J-box<br>Threaded connectors<br>Top Integral cable                       | 3 A/port, 3 A total<br>Black PVC cable<br>10x24 AWG                                      | <u>Function</u><br>+V<br>-V<br>Port 1<br>Port 2<br>Port 3 | <u>Color</u><br>BN<br>BU<br>WH<br>GN<br>YE                 | <u>Function</u><br>Port 4<br>Port 5<br>Port 6<br>Port 7<br>Port 8 | <u>Color</u><br>GY<br>PK<br>RD<br>BK<br>VT                 | VB 803M-*    | VB 803M-PX9-*    |
| 8-port J-box<br>1 signal per port<br>Threaded connectors<br>Side Integral cable | 3 A/port, 4 A total<br>Black PVC cable<br>10x24 AWG                                      |   |  |   |  | VB 803M-*C   | VB 803M-PX9-*C   |
| 8-port J-box,<br>Threaded connectors<br>M16 connector                           | 3 A/port, 3 A total<br>14 pin M16 connector<br>10 conductors. Mates<br>with BKM 14-836-* | <u>Function</u><br>+V<br>-V<br>Port 1<br>Port 2<br>Port 3 | <u>Pin / Color</u><br>M/BN<br>U/BU<br>P/WH<br>E/GN<br>O/YE | <u>Function</u><br>Port 4<br>Port 5<br>Port 6<br>Port 7<br>Port 8 | <u>Pin / Color</u><br>C/GY<br>N/PK<br>R/RD<br>G/BK<br>S/VT | VB 803M-BS14 | VB 803M-PX9-BS14 |

We reserve the right to make technical alterations without prior notice.

### Functional Wiring Diagrams

No LED Version

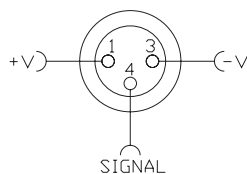

LED Version

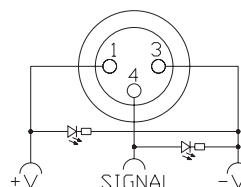

### Specifications

|                        |  |                      |   |
|------------------------|--|----------------------|---|
| <b>Housing:</b>        | Nylon  | <b>Temperature:</b>  | -30 °C to +80 °C (-22 °F to +176 °F)  |
| <b>Connectors:</b>     | TPU (Picofast); nylon or TPU (Eurofast®); PETP (M16) | <b>Protection:</b>   | IEC IP 67   |
| <b>Contacts:</b>       | Gold plated brass                                    | <b>Accessories:</b>  | KS 5/10 labels, 2 pieces PSG-CC (snap lock) or PSGM-CC (threaded) included  |
| <b>Thread Inserts:</b> | Nickel plated brass                                  | <b>Cable Length:</b> | Standard length for junction boxes and M16 quick disconnect cordsets is nominal 5 meters<br>Other lengths available by request. Consult factory |
| <b>Cable:</b>          | See table  |                      |   |

### Dimensions

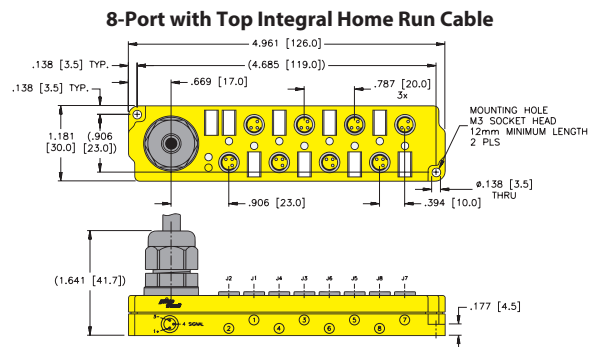
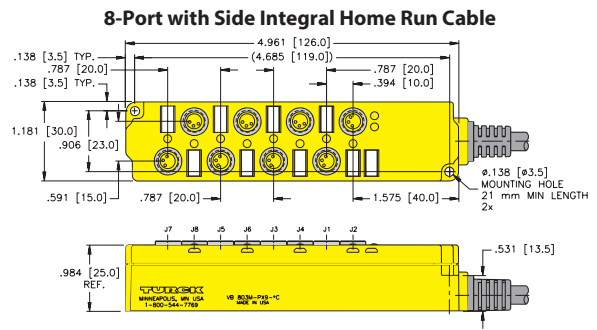
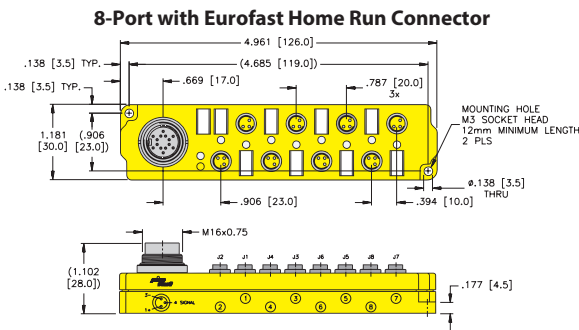

We reserve the right to make technical alterations without prior notice.

multibox®, picofast®

### Pinout

| 3-pin Picofast | 14-pin Versafast™ |
|----------------|-------------------|
| Female         | Male              |
|                |                   |

# Junction Box Connectivity Products

## Multibox® Picofast® Junction Boxes, 4-Port, 4-pin

- Dual Input/Output per Port
- Snap Lock or Threaded Connectors
- M16 Quick Disconnect or Integral Home Run Cable



### 4-Port, 4-pin, Snap Lock, 10-48 VDC

| Application   | Specifications   | Pinout          |                    |                 |                    | No LEDs      |
|---|--|-----------------|--------------------|-----------------|--------------------|--------------|
| 4-port J-box<br>2 signals per port<br>Snap lock connectors<br>Top integral cable  | 3 A/port, 4 A total<br>Black PVC cable   | <u>Function</u> | <u>Color</u>       | <u>Function</u> | <u>Color</u>       | VB 404Z-*    |
| 4-port J-box<br>2 signals per port<br>Snap lock connectors<br>Side integral cable |  | Port 1/2        | RD                 | Port 4/2        | BK                 |              |
| 4-port J-box<br>2 signals per port<br>Snap lock connectors<br>Side integral cable | 10x24 AWG foil shield<br>and 26 AWG drain  | Port 1/4        | PK                 | Port 4/4        | VT                 | VB 404Z-*C   |
| 4-port J-box<br>2 signals per port<br>Snap lock connectors<br>M16 connector       | 2 A/port, 3 A total<br>w/1 power pair<br>6 A total w/dual power<br>14-pin M16 connector<br>10/12 conductors<br>Mates with BKM 14-917-* | <u>Function</u> | <u>Pin / Color</u> | <u>Function</u> | <u>Pin / Color</u> | VB 404Z-BS14 |
|   | +V   | A/RD/BU         | Port 2/2           | O/YE            |                    |              |
|   | -V   | L/GY/PK         | Port 2/4           | C/GY            |                    |              |
|   | +V   | M/BN            | Port 3/2           | E/GN            |                    |              |
|   | -V   | U/BU            | Port 3/4           | P/WH            |                    |              |
|   | Port 1/2   | R/RD            | Port 4/2           | G/BK            |                    |              |
|   | Port 1/4   | N/PK            | Port 4/4           | S/VT            |                    |              |

### 4-Port, 4-pin, Threaded, 10-48 VDC

| Application  | Specifications  | Pinout          |                    |                 |                    | No LEDs      |
|--|---|-----------------|--------------------|-----------------|--------------------|--------------|
| 4-port J-box<br>2 signals per port<br>Threaded connectors<br>Top integral cable  | 3 A/port, 4 A total<br>Black PVC cable  | <u>Function</u> | <u>Color</u>       | <u>Function</u> | <u>Color</u>       | VB 404M-*    |
| 4-port J-box<br>2 signals per port<br>Threaded connectors<br>Side integral cable |   | Port 1/2        | RD                 | Port 3/2        | WH                 |              |
| 4-port J-box<br>2 signals per port<br>Threaded connectors<br>Side integral cable | 10x24 AWG foil shield<br>and 26 AWG drain   | Port 1/4        | PK                 | Port 4/2        | BK                 | VB 404M-*C   |
| 4-port J-box<br>2 signals per port<br>Threaded connectors<br>M16 connector       | 2 A/port<br>3 A total w/1 power pair<br>6 A total w/dual power<br>14-pin M16 connector<br>10/12 conductors<br>Mates with BKM 14-917-* | <u>Function</u> | <u>Pin / Color</u> | <u>Function</u> | <u>Pin / Color</u> | VB 404M-BS14 |
|  | +V  | A/RD/BU         | Port 2/2           | O/YE            |                    |              |
|  | -V  | L/GY/PK         | Port 2/4           | C/GY            |                    |              |
|  | +V  | M/BN            | Port 3/2           | E/GN            |                    |              |
|  | -V  | U/BU            | Port 3/4           | P/WH            |                    |              |
|  | Port 1/4  | R/RD            | Port 4/2           | G/BK            |                    |              |
|  | Port 1/2  | N/PK            | Port 4/4           | S/VT            |                    |              |

\* Cable length in meters.

We reserve the right to make technical alterations without prior notice.

### Functional Wiring Diagrams

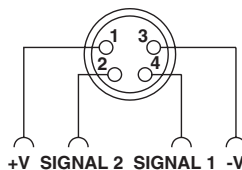

### Specifications

|                        |                                  |                              |  |
|------------------------|----------------------------------|------------------------------|--|
| <b>Housing:</b>        | Nylon                            | <b>Temperature:</b>          | -30 °C to +80 °C (-22 °F to +176 °F)                                       |
| <b>Connectors:</b>     | TPU or nylon (J1-J4) or Nylon P1 | <b>Protection:</b>           | IEC IP67   |
| <b>Contacts:</b>       | Gold plated brass                | <b>Accessories:</b>          | KS 5/10 labels, 2 pieces PSG-CC (snap lock) or PSGM-CC (threaded) included |
| <b>Thread Inserts:</b> | Nickel plated brass              | <b>Cable Length:</b>         | Standard length is nominal 5 meters  |
| <b>Cable:</b>          | See table                        | <b>Recommended Splitter:</b> | YP2-MFS 4/2MFK 3, for threaded version only                                |

### Dimensions

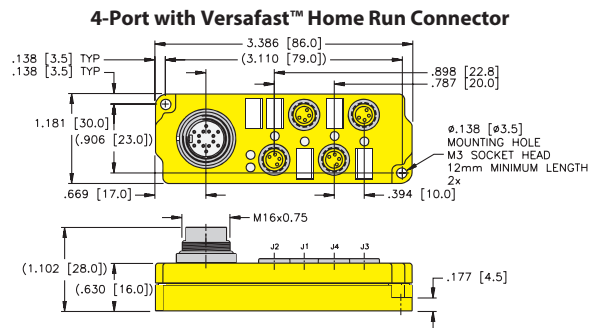
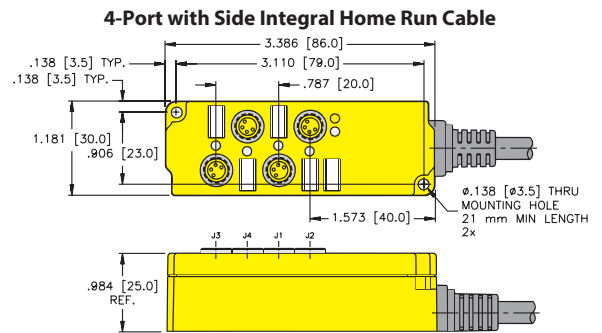
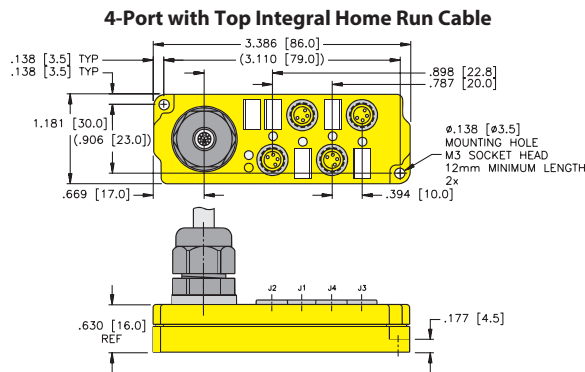

We reserve the right to make technical alterations without prior notice.

multibox®, picofast®

### Pinout

| 4-pin Picofast | 14-pin Versafast |
|----------------|------------------|
| Female         | Male             |
|                |                  |

# Junction Box Connectivity Products

## Multibox® Picofast® Junction Boxes, 8-Port, 4-pin

- Dual Input/Output per Port
- Snap Lock or Threaded Connectors
- M16 Quick Disconnect or Integral Home Run Cable



### 4-Port, 4-pin, Snap Lock, 10-48 VDC

| Application   | Specifications   | Pinout          |                    |                 |                    | No LEDs      |
|---|--|-----------------|--------------------|-----------------|--------------------|--------------|
| 8-port J-box<br>2 signals per port<br>Snap lock connectors<br>Top integral cable  | 3 A/port, 4 A total<br>Black PVC cable<br>10x24 AWG                                    | <u>Function</u> | <u>Color</u>       | <u>Function</u> | <u>Color</u>       | VB 804Z-*    |
| 8-port J-box<br>2 signals per port<br>Snap lock connectors<br>Side integral cable |  | - V             | BU                 | Port 4/4        | WH                 |              |
|   |  | +V              | BN                 | Port 5/2        | PK                 | VB 804Z-*    |
|   |  | Port 1/2        | RD                 | Port 5/4        | GY                 |              |
|   |  | Port 1/4        | OG                 | Port 6/2        | YE / BN            | VB 804Z-*    |
|   |  | Port 2/2        | VT                 | Port 6/4        | YE                 |              |
|   |  | Port 2/4        | RD / BI            | Port 7/2        | GY / PK            | VB 804Z-*    |
|   |  | Port 3/2        | GY / BN            | Port 7/4        | WH / GN            |              |
|   |  | Port 3/4        | TN                 | Port 8/2        | WH / YE            | VB 804Z-*    |
|   |  | Port 4/2        | BK                 | Port 8/4        | GN                 |              |
| 8-port J-box<br>2 signals per port<br>Snap lock connectors<br>M16 connector       | 3 A/port, 4 A total<br>19-pin M16 connector<br>18 conductor<br>Mates with BKM 19-995-* | <u>Function</u> | <u>Pin / Color</u> | <u>Function</u> | <u>Pin / Color</u> | VB 804Z-BS19 |
|   |  | +V              | L/BN               | Port 4/4        | P/WH               |              |
|   |  | - V             | A/BU               | Port 5/2        | G/PK               | VB 804Z-BS19 |
|   |  | Port 1/2        | R/RD               | Port 5/4        | S/GY               |              |
|   |  | Port 1/4        | M/OG               | Port 6/2        | K/YE/BN            | VB 804Z-BS19 |
|   |  | Port 2/2        | O/VT               | Port 6/4        | T/YE               |              |
|   |  | Port 2/4        | C/RD/BU            | Port 7/2        | B/GY/PK            | VB 804Z-BS19 |
|   |  | Port 3/2        | N/GY/BN            | Port 7/4        | D/WH/GN            |              |
|   |  | Port 3/4        | U/TN               | Port 8/2        | H/WH/YE            | VB 804Z-BS19 |
|   |  | Port 4/2        | E/BK               | Port 8/4        | I/GN               |              |

We reserve the right to make technical alterations without prior notice.

### 8-Port, 4-pin, Threaded, 10-48 VDC

| Application  | Specifications   | Pinout          |                    |                 |                    | No LEDs      |
|--|--|-----------------|--------------------|-----------------|--------------------|--------------|
| 8-port J-box<br>2 signals per port<br>Threaded connectors<br>Top integral cable  | 3 A/port, 4 A total<br>Black PVC cable<br>10x24 AWG                                    | <u>Function</u> | <u>Color</u>       | <u>Function</u> | <u>Color</u>       | VB 804M-*    |
| 8-port J-box<br>2 signals per port<br>Threaded connectors<br>Side integral cable |  | - V             | BU                 | Port 4/4        | WH                 |              |
|  |  | +V              | BN                 | Port 5/2        | PK                 | VB 804M-*    |
|  |  | Port 1/2        | RD                 | Port 5/4        | GY                 |              |
|  |  | Port 1/4        | OG                 | Port 6/2        | YE / BN            | VB 804M-*    |
|  |  | Port 2/2        | VT                 | Port 6/4        | YE                 |              |
|  |  | Port 2/4        | RD / BI            | Port 7/2        | GY / PK            | VB 804M-*    |
|  |  | Port 3/2        | GY / BN            | Port 7/4        | WH / GN            |              |
|  |  | Port 3/4        | TN                 | Port 8/2        | WH / YE            | VB 804M-*    |
|  |  | Port 4/2        | BK                 | Port 8/4        | GN                 |              |
| 8-port J-box<br>2 signals per port<br>Threaded connectors<br>M16 connector       | 3 A/port, 4 A total<br>19-pin M16 connector<br>18 conductor<br>Mates with BKM 19-995-* | <u>Function</u> | <u>Pin / Color</u> | <u>Function</u> | <u>Pin / Color</u> | VB 804M-BS19 |
|  |  | +V              | L/BN               | Port 4/4        | P/WH               |              |
|  |  | - V             | A/BU               | Port 5/2        | G/PK               | VB 804M-BS19 |
|  |  | Port 1/2        | R/RD               | Port 5/4        | S/GY               |              |
|  |  | Port 1/4        | M/OG               | Port 6/2        | K/YE/BN            | VB 804M-BS19 |
|  |  | Port 2/2        | O/VT               | Port 6/4        | T/YE               |              |
|  |  | Port 2/4        | C/RD/BU            | Port 7/2        | B/GY/PK            | VB 804M-BS19 |
|  |  | Port 3/2        | N/GY/BN            | Port 7/4        | D/WH/GN            |              |
|  |  | Port 3/4        | U/TN               | Port 8/2        | H/WH/YE            | VB 804M-BS19 |
|  |  | Port 4/2        | E/BK               | Port 8/4        | I/GN               |              |

### Functional Wiring Diagrams

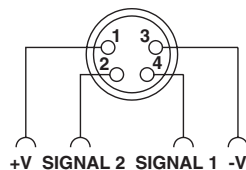

### Specifications

|                        |                                 |                              |  |
|------------------------|---------------------------------|------------------------------|--|
| <b>Housing:</b>        | Nylon                           | <b>Temperature:</b>          | -30 °C to +80 °C (-22 °F to +176 °F)                                       |
| <b>Connectors:</b>     | TPU or nylon (J1-8), Nylon (P1) | <b>Protection:</b>           | IEC IP67   |
| <b>Contacts:</b>       | Gold plated brass               | <b>Accessories:</b>          | KS 5/10 labels, 2 pieces PSG-CC (snap lock) or PSGM-CC (threaded) included |
| <b>Thread Inserts:</b> | Nickel plated brass             | <b>Cable Length:</b>         | Standard length is nominal 5 meters  |
| <b>Cable:</b>          | See table                       | <b>Recommended Splitter:</b> | YP2-MFS 4/2 MFK3, for threaded version only                                |

### Dimensions

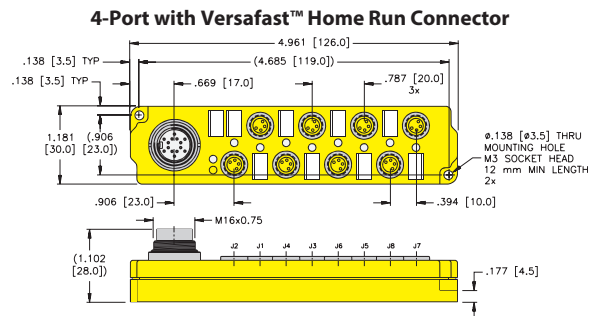
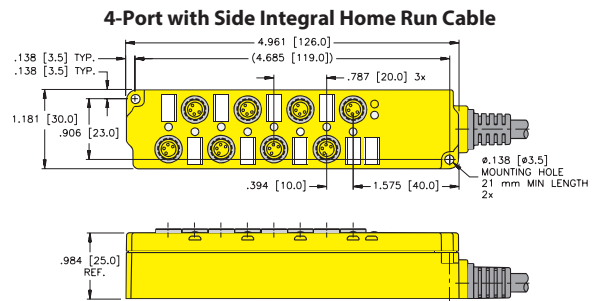
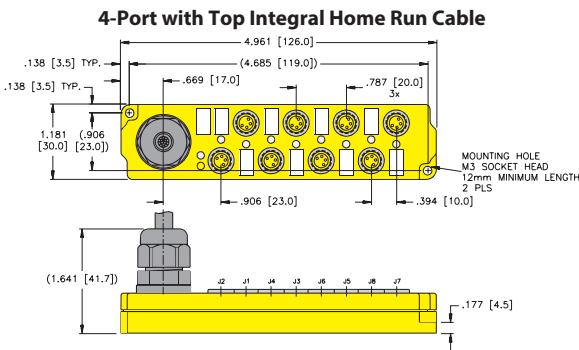

We reserve the right to make technical alterations without prior notice.

multibox®, picofast®

### Pinout

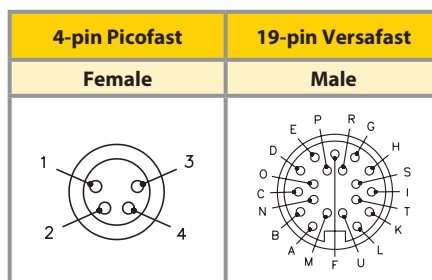

# Junction Box Connectivity Products

## Multibox® Picofast® Junction Boxes, 10-Port

- 10 Inputs/Outputs
- M16 Quick Disconnect or Integral Home Run Cable
- For Use with 3-pin Snap Lock Picofast Cordsets
- Available with or without LEDs

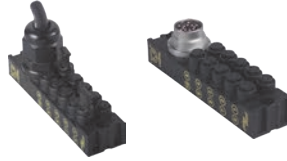

### 10-Port, J-box, Snap Lock, 48 VDC

| Application  | Specifications   | Pinout          |                    |                 |                    | No LEDs      | PNP LED           |
|--|--|-----------------|--------------------|-----------------|--------------------|--------------|-------------------|
| 10-port J-box<br>Standard wiring<br>Integral cable | 3 A/port, 3 A total<br>Black PVC cable<br>12x24 AWG<br>Foil shield and 26 AWG<br>drain                 | <u>Function</u> | <u>Color</u>       | <u>Function</u> | <u>Color</u>       | VB 1003-*    | VB 1003-PX10-*    |
|  |  | +V              | BN                 | Port 5          | TN                 |              |                   |
|  |  | -V              | BU                 | Port 6          | WH                 |              |                   |
|  |  | Port 1          | RD                 | Port 7          | GN                 |              |                   |
|  |  | Port 2          | BK                 | Port 8          | YE                 |              |                   |
| Port 3   | VT   | Port 9          | GY                 |                 |                    |              |                   |
| Port 4   | OG   | Port 10         | PK                 |                 |                    |              |                   |
| 10-port J-box<br>Standard wiring<br>M16 connector  | 3 A/port, 3 A total<br>14 pin connector<br>M16 threads. Mates with<br>BKM 14-755-*<br>or BKWM 14-755-* | <u>Function</u> | <u>Pin / Color</u> | <u>Function</u> | <u>Pin / Color</u> | VB 1003-BS14 | VB 1003-PX10-BS14 |
|  |  | +V              | M/BN               | Port 5          | N/TN               |              |                   |
|  |  | -V              | U/BU               | Port 6          | R/WH               |              |                   |
|  |  | Port 1          | P/RD               | Port 7          | G/GN               |              |                   |
|  |  | Port 2          | E/BK               | Port 8          | S/YE               |              |                   |
| Port 3   | O/VT   | Port 9          | J/GY               |                 |                    |              |                   |
| Port 4   | C/OG   | Port 10         | T/PK               |                 |                    |              |                   |

\* Length in meters.

We reserve the right to make technical alterations without prior notice.

### Functional Wiring Diagrams

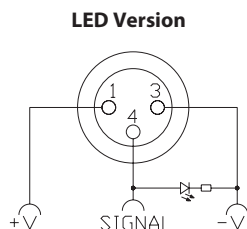
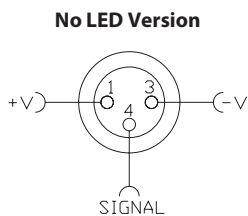

### Pinout

| 3-pin Picofast | 14-pin Versafast™ |
|----------------|-------------------|
| Female         | Male              |
|                |                   |



### Specifications

|                    |                   |                      |   |
|--------------------|-------------------|----------------------|---|
| <b>Housing:</b>    | Nylon             | <b>Temperature:</b>  | -30 °C to +80 °C (-22 °F to +176 °F)  |
| <b>Connectors:</b> | TPU or Nylon      | <b>Protection:</b>   | IEC IP67  |
| <b>Contacts:</b>   | Gold plated brass | <b>Accessories:</b>  | Closure cap, PSG-CC (optional - 2 included)   |
|                    |                   | <b>Cable Length:</b> | Standard length for junction boxes and M16 cordsets is nominal 5 meters<br>Other lengths available by request - Consult factory |

### Dimensions

10-Port with Integral Home Run Cable

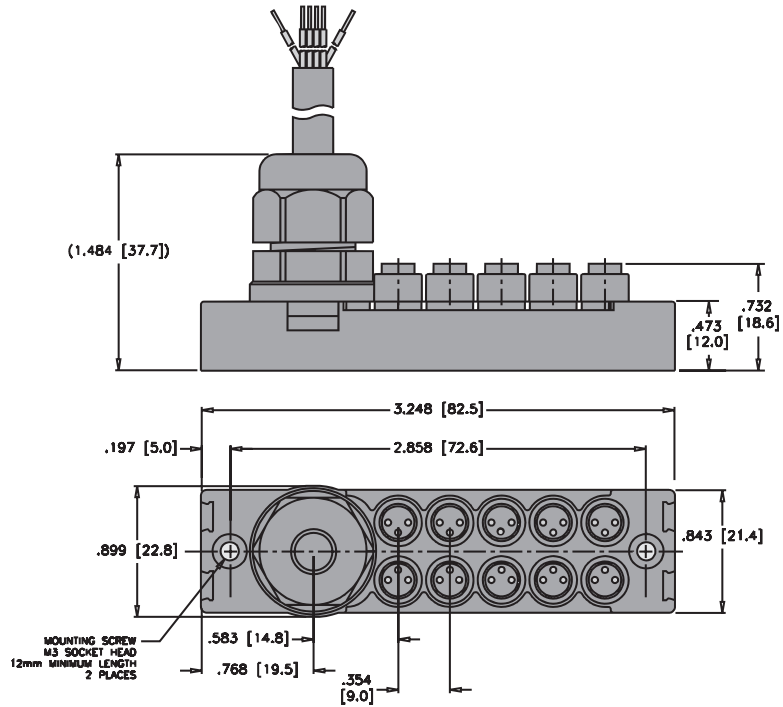

10-Port with M16 Home Run Connector

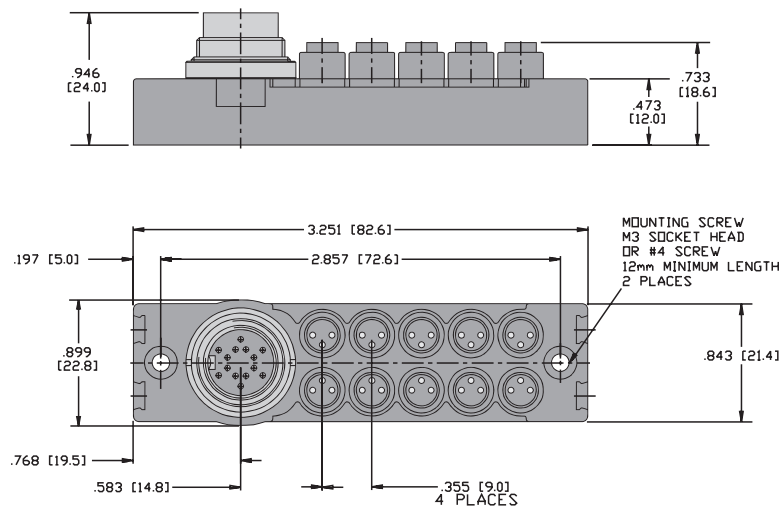

We reserve the right to make technical alterations without prior notice.

multibox®, picofast®

# Junction Box Connectivity Products

## Multibox® Minifast® Junction Boxes, 3-Pin

- 4, 6 and 8 Ports
- M23 Quick Disconnect, Minifast Connector or Integral Home Run Cable
- Simplifies Wiring Installations



### 4-Port, 250 VAC/300 VDC

| Application   | Specifications  | Pinout   |  |   |  | Part Number    |
|---|---|--|--|---|--|----------------|
| 4-port J-box<br>Standard wiring<br>Integral cable       | 4 A/port, 9 A total<br>PVC cable, black, 6x18<br>AWG, foil shield and<br>20 AWG drain         | <u>Function</u><br>Common (L1)<br>Ground<br>J1 Load (L2) | <u>Color</u><br>WH<br>GN<br>RD                   | <u>Function</u><br>J2 Load (L2)<br>J3 Load (L2)<br>J4 Load (L2) | <u>Color</u><br>OG<br>BK<br>BU                   | 4 RKF 30-*M    |
| 4-port J-box<br>Standard wiring<br>Multifast® connector | 4 A/port, 7 A total<br>12-pin Multifast connector,<br>6 conductors. Mates with<br>CKRM 12-6-* | <u>Function</u><br>Common (L1)<br>Ground<br>J1 Load (L2) | <u>Pin / Color</u><br>5 / WH<br>7 / GN<br>6 / RD | <u>Function</u><br>J2 Load (L2)<br>J3 Load (L2)<br>J4 Load (L2) | <u>Pin / Color</u><br>1 / OG<br>4 / BK<br>2 / BU | 4 RKF 30-CS12  |
| 4-port J-box<br>Standard wiring<br>Minifast connector   | 4 A/port, 6 A total<br>6-pin Minifast connector,<br>6 conductors. Mates with<br>RKM 61-*M     | <u>Function</u><br>Common (L1)<br>Ground<br>J1 Load (L2) | <u>Pin / Color</u><br>1 / WH<br>3 / GN<br>2 / RD | <u>Function</u><br>J2 Load (L2)<br>J3 Load (L2)<br>J4 Load (L2) | <u>Pin / Color</u><br>4 / OG<br>5 / BK<br>6 / BU | 4 RKF 30-B1161 |

### 6-Port, 250 VAC/300 VDC

| Application  | Specifications  | Pinout   |  |   |  | Part Number   |
|--|---|--|--|---|--|---------------|
| 6-port J-box<br>Standard wiring<br>Integral cable      | 4 A/port, 9 A total<br>PVC cable, black, 8x18<br>AWG, foil shield and<br>20 AWG drain         | <u>Function</u><br>Common (L1)<br>Ground<br>J1 Load (L2)<br>J2 Load (L2) | <u>Color</u><br>WH<br>GN<br>RD<br>OG                       | <u>Function</u><br>J3 Load (L2)<br>J4 Load (L2)<br>J5 Load (L2)<br>J6 Load (L2) | <u>Color</u><br>BK<br>BU<br>YE<br>BN                       | 6 RKF 30-*M   |
| 6-port J-box<br>Standard wiring Multifast<br>connector | 4 A/port, 7 A total<br>12-pin Multifast connector,<br>8 conductors. Mates with<br>CKRM 12-8-* | <u>Function</u><br>Common (L1)<br>Ground<br>J1 Load (L2)<br>J2 Load (L2) | <u>Pin / Color</u><br>5 / WH<br>7 / GN<br>6 / RD<br>1 / OG | <u>Function</u><br>J3 Load (L2)<br>J4 Load (L2)<br>J5 Load (L2)<br>J6 Load (L2) | <u>Pin / Color</u><br>4 / BK<br>2 / BU<br>3 / YE<br>8 / BN | 6 RKF 30-CS12 |

### 8-Port, 250 VAC/300 VDC

| Application  | Specifications  | Pinout   |  |   |   | Part Number   |
|--|---|--|--|---|---|---------------|
| 8-port J-box<br>Standard wiring<br>Integral cable      | 4 A/port, 9 A total<br>PVC cable, black, 10x18<br>AWG, foil shield and 20<br>AWG drain          | <u>Function</u><br>Common (L1)<br>Ground<br>J1 Load (L2)<br>J2 Load (L2)<br>J3 Load (L2) | <u>Color</u><br>WH<br>GN<br>RD<br>VT<br>BK                           | <u>Function</u><br>J4 Load (L2)<br>J5 Load (L2)<br>J6 Load (L2)<br>J7 Load (L2)<br>J8 Load (L2) | <u>Color</u><br>BU<br>GY<br>YE<br>OG<br>BN                            | 8 RKF 30-*M   |
| 8-port J-box<br>Standard wiring Multifast<br>connector | 4 A/port, 7 A total<br>12-pin Multifast connector,<br>10 conductors. Mates with<br>CKRM 12-10-* | <u>Function</u><br>Common (L1)<br>Ground<br>J1 Load (L2)<br>J2 Load (L2)<br>J3 Load (L2) | <u>Pin / Color</u><br>5 / WH<br>7 / GN<br>6 / RD<br>1 / VT<br>4 / BK | <u>Function</u><br>J4 Load (L2)<br>J5 Load (L2)<br>J6 Load (L2)<br>J7 Load (L2)<br>J8 Load (L2) | <u>Pin / Color</u><br>2 / BU<br>3 / GY<br>8 / YE<br>9 / OG<br>10 / BN | 8 RKF 30-CS12 |

\* Length in meters.

We reserve the right to make technical alterations without prior notice.

### Specifications

|                    |  |                          |   |
|--------------------|--|--------------------------|---|
| <b>Housing:</b>    | Die cast aluminum alloy                                | <b>Temperature:</b>      | -40 °C to +90 °C (-40 °F to +194 °F)  |
| <b>Connectors:</b> | Nickel plated brass, oil resistant TPU contact carrier | <b>Protection Class:</b> | IEC IP67  |
| <b>Contacts:</b>   | Gold plated brass                                      | <b>Cable Length:</b>     | Standard cable length is 6 meters. Other lengths available by request - consult factory |
| <b>Cable:</b>      | See table for specifications                           |                          |   |

### Dimensions

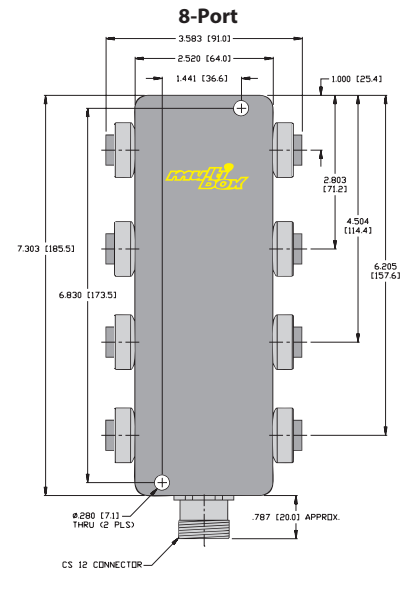
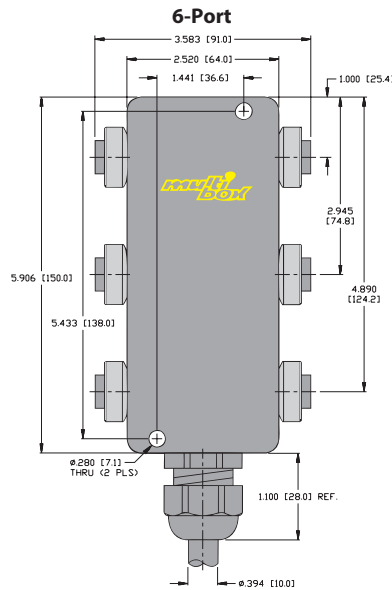
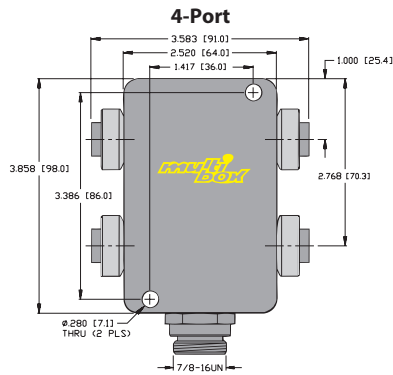

We reserve the right to make technical alterations without prior notice.

multibox®, minifast®

#### Notes

Clearance holes for 1/4-20 screws (2 places).  
All housings are 34 mm in height.

#### Pinout

| 3-pin Minifast | 6-pin Minifast | 12-pin Multifast® |
|----------------|----------------|-------------------|
| Female         | Male           | Male              |
|                |                |                   |

#### Wiring Diagrams

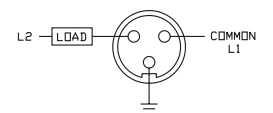

Load (L2) is individual output. Common (L1) and Ground are wired parallel internally.

# Junction Box Connectivity Products

## Multibox® Minifast® Junction Boxes, 3-pin

- 6 and 8 Ports
- Quick Disconnect Minifast Connector
- Simplifies Wiring Installations



### 6-Port, 250 VAC / 300 VDC

| Application  | Specifications           | Pinout          |                    |                 |                    | Part Number    |
|--|--------------------------|-----------------|--------------------|-----------------|--------------------|----------------|
| 6-port J-box<br>Standard wiring,<br>Minifast connector | 4 A/port                 | <u>Function</u> | <u>Pin / Color</u> | <u>Function</u> | <u>Pin / Color</u> | 6 RKF 30-RSF80 |
|  | 8 A total                | Common (L1)     | 5 / WH             | J3 Load (L2)    | 4 / BK             |                |
|  | 8-pin Minifast connector | Ground          | 7 / GN             | J4 Load (L2)    | 2 / BU             |                |
|  | 8 conductors. Mates with | J1 Load (L2)    | 6 / RD             | J5 Load (L2)    | 3 / WH / BK        |                |
|  | RKM 86-*M                | J2 Load (L2)    | 1 / OG             | J6 Load (L2)    | 8 / RD / BK        |                |

### 8-Port, 250 VAC / 300 VDC

| Application  | Specifications            | Pinout          |                    |                 |                    | Part Number     |
|--|---------------------------|-----------------|--------------------|-----------------|--------------------|-----------------|
| 8-port J-box<br>Standard wiring,<br>Minifast connector | 4 A/port                  | <u>Function</u> | <u>Pin / Color</u> | <u>Function</u> | <u>Pin / Color</u> | 8 RKF 30-RSF100 |
|  | 7 A total                 | Common (L1)     | 10 / WH            | J4 Load (L2)    | 2 / BU             |                 |
|  | 10-pin Minifast connector | Ground          | 8 / GN             | J5 Load (L2)    | 3 / WH / BK        |                 |
|  | 10 conductors. Mates with | J1 Load (L2)    | 7 / RD             | J6 Load (L2)    | 4 / RD / BK        |                 |
|  | RKM 106-*M                | J2 Load (L2)    | 1 / OG             | J7 Load (L2)    | 5 / GN / BK        |                 |
|  |                           | J3 Load (L2)    | 9 / BK             | J8 Load (L2)    | 6 / OG / BK        |                 |

We reserve the right to make technical alterations without prior notice.

## Functional Wiring Diagrams

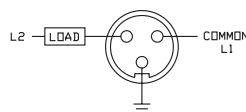

### Specifications

|                    |  |                     |                                      |
|--------------------|--|---------------------|--------------------------------------|
| <b>Housing:</b>    | Die cast aluminum alloy                                | <b>Temperature:</b> | -30 °C to +80 °C (-22 °F to +176 °F) |
| <b>Connectors:</b> | Nickel plated brass, oil resistant TPU contact carrier | <b>Protection:</b>  | IEC IP67                             |
| <b>Contacts:</b>   | Gold plated brass                                      |                     |                                      |

### Dimensions

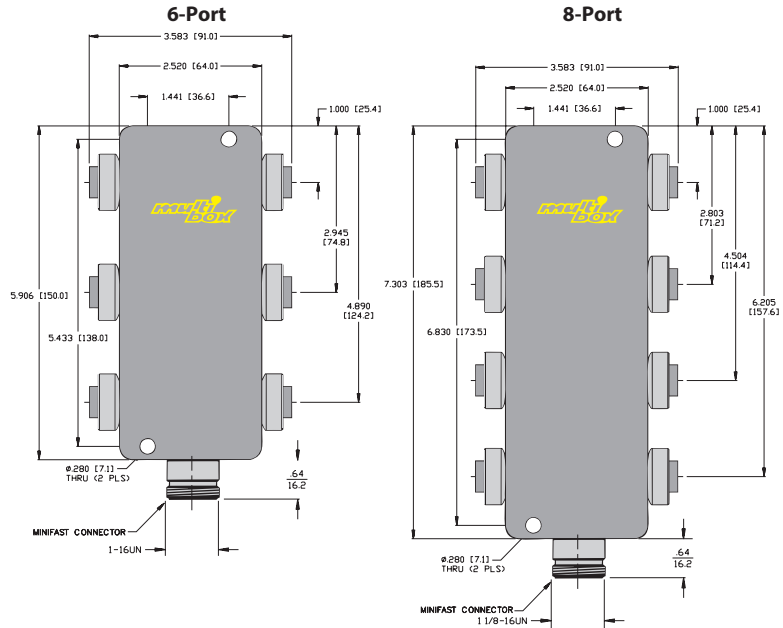

We reserve the right to make technical alterations without prior notice.

multibox®, minifast®

#### Notes

Clearance holes for 1/4-20 screws (2 places).  
All housings are 34 mm in height.

#### Pinout

| 3-pin Minifast | 8-pin Minifast | 10-pin Minifast |
|----------------|----------------|-----------------|
| Female         | Male           | Male            |
|                |                |                 |

# Junction Box Connectivity Products

## Multibox® Minifast® Junction Boxes with LEDs, 3-pin

- 4 and 8 Ports
- M23 Quick Disconnect or Integral Home Run Cable
- Simplifies Wiring Installations
- LEDs for Power and Signal



### 4-Port, 40-120 VAC

| Application  | Specifications  | Pinout   |   |   |  | Part Number      |
|--|---|--|---|---|--|------------------|
| 4 port J-box<br>Standard wiring<br>Integral cable      | 4 A/port, 9 A total<br>PVC cable, black,<br>7x18 AWG, foil shield<br>and 20 AWG drain         | <u>Function</u><br>Common (L1)<br>LED Power (L2)<br>Ground<br>J1 Load (L2) | <u>Color</u><br>WH<br>WH / BK<br>GN<br>RD                     | <u>Function</u><br>J2 Load (L2)<br>J3 Load (L2)<br>J4 Load (L2) | <u>Color</u><br>OG<br>BK<br>BU                   | 4 RKF 30-X5-*M   |
| 4 port J-box<br>Standard wiring<br>Multifast connector | 4 A/port, 7 A total<br>12-pin Multifast<br>connector, 7 conductors.<br>Mates with CKBM 12-7-* | <u>Function</u><br>Common (L1)<br>LED Power (L2)<br>Ground<br>J1 Load (L2) | <u>Pin / Color</u><br>3 / WH<br>1 / WH/BK<br>7 / GN<br>4 / RD | <u>Function</u><br>J2 Load (L2)<br>J3 Load (L2)<br>J4 Load (L2) | <u>Pin / Color</u><br>5 / OG<br>2 / BK<br>6 / BU | 4 RKF 30-X5-CS12 |

### 8-Port, 40-120 VAC

| Application   | Specifications   | Pinout   |  |   |  | Part Number      |
|---|--|--|--|---|--|------------------|
| 8 port J-box<br>Standard wiring<br>Integral cable       | 4 A/port, 9 A total<br>PVC cable, black,<br>11x18 AWG, foil shield<br>and 20 AWG drain             | <u>Function</u><br>Common (L1)<br>LED Power (L2)<br>Ground<br>J1 Load (L2)<br>J2 Load (L2)<br>J3 Load (L2) | <u>Color</u><br>WH<br>BU / BK<br>GN<br>RD<br>OG<br>BK                                | <u>Function</u><br>J4 Load (L2)<br>J5 Load (L2)<br>J6 Load (L2)<br>J7 Load (L2)<br>J8 Load (L2) | <u>Color</u><br>BU<br>WH / BK<br>RD / BK<br>GN / BK<br>OG / BK                           | 8 RKF 30-X9-*M   |
| 8 port J-box,<br>Standard wiring<br>Multifast connector | 4 A/port, 7 A total<br>12-pin Multifast<br>connector, 11<br>conductors. Mates with<br>CKBM 12-11-* | <u>Function</u><br>Common (L1)<br>LED Power (L2)<br>Ground<br>J1 Load (L2)<br>J2 Load (L2)<br>J3 Load (L2) | <u>Pin / Color</u><br>11 / WH<br>7 / BU/BK<br>9 / GN<br>10 / RD<br>1 / OG<br>12 / BK | <u>Function</u><br>J4 Load (L2)<br>J5 Load (L2)<br>J6 Load (L2)<br>J7 Load (L2)<br>J8 Load (L2) | <u>Pin / Color</u><br>2 / BU<br>3 / WH / BK<br>4 / RD / BK<br>5 / GN / BK<br>6 / OG / BK | 8 RKF 30-X9-CS12 |

\* Length in meters.

We reserve the right to make technical alterations without prior notice.

### Functional Wiring Diagrams

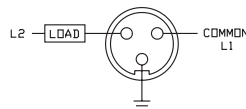

### Specifications

|                    |  |                          |   |
|--------------------|--|--------------------------|---|
| <b>Housing:</b>    | Die cast aluminum alloy                                | <b>Temperature:</b>      | -30 °C to +80 °C (-22 °F to +176 °F)  |
| <b>Connectors:</b> | Nickel plated brass, oil resistant TPU contact carrier | <b>Protection Class:</b> | IEC IP67  |
| <b>Contacts:</b>   | Gold plated brass                                      | <b>Cable Length:</b>     | Standard cable length is 6 meters. Other lengths available by request - consult factory |
| <b>Cable:</b>      | See table for specifications                           |                          |   |

### Dimensions

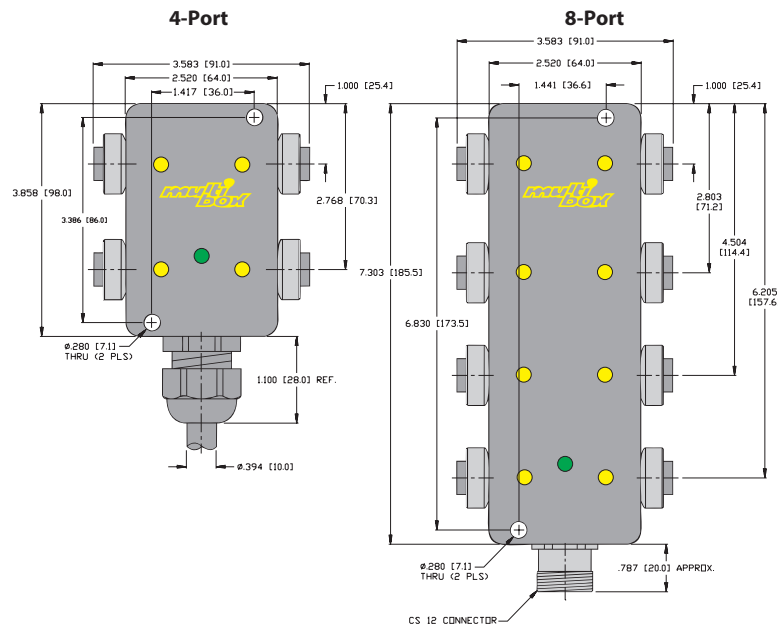

We reserve the right to make technical alterations without prior notice.

multibox®, minifast®

#### Notes

- Clearance holes for 1/4-20 screws (2 places).
- All housings are 34 mm in height.
- Green LED = Power on (center position)
- Yellow LED = Signal (outer position).

#### Pinout

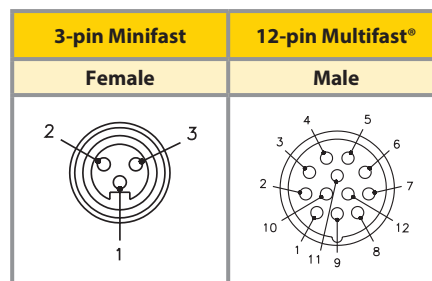

# Junction Box Connectivity Products

## Multibox® Minifast® Junction Boxes with LEDs, 3-pin

- 4 and 8 Ports
- Quick Disconnect Minifast Connector
- Simplifies Wiring Installations
- LEDs for Power and Signal



### 4-Port, 40-120 VAC

| Application  | Specifications                        | Pinout          |              |                 |              | Part Number       |
|--|---------------------------------------|-----------------|--------------|-----------------|--------------|-------------------|
| 4-port J-box<br>Standard wiring,<br>Minifast connector | 4 A/port                              | <u>Function</u> | <u>Color</u> | <u>Function</u> | <u>Color</u> | 4 RKF 30-X5-RSF70 |
|  | 8 A total                             | Common (L1)     | 3 / WH       | J2 Load (L2)    | 5 / OG       |                   |
|  | 7-pin Minifast connector              | LED Pwr (L2)    | 1 / WH / BK  | J3 Load (L2)    | 2 / BK       |                   |
|  | 7 conductors. Mates with<br>RKM 76-*M | Ground          | 7 / GN       | J4 Load (L2)    | 6 / BU       |                   |
|  |                                       | J1 Load (L2)    | 4 / RD       |                 |              |                   |

### 8-Port, 40-120 VAC

| Application  | Specifications                          | Pinout          |              |                 |              | Part Number        |
|--|---|-----------------|--------------|-----------------|--------------|--------------------|
| 8-port J-box<br>Standard wiring,<br>Minifast connector | 4 A/port                                | <u>Function</u> | <u>Color</u> | <u>Function</u> | <u>Color</u> | 8 RKF 30-X9-RSF120 |
|  | 7 A total                               | Common (L1)     | 11 / WH      | J4 Load (L2)    | 2 / BU       |                    |
|  | 12-pin Minifast connector               | LED Pwr (L27)   | 1 / BU / BK  | J5 Load (L2)    | 3 / WH / BK  |                    |
|  | 11 conductors. Mates with<br>RKM 126-*M | Ground          | 9 / GN       | J6 Load (L2)    | 4 / RD / BK  |                    |
|  |   | J1 Load (L2)    | 10 / RD      | J7 Load (L2)    | 5 / GN / BK  |                    |
|  |   | J2 Load (L2)    | 1 / OG       | J8 Load (L2)    | 6 / OG / BK  |                    |
|  |   | J3 Load (L2)    | 12 / BK      |                 |              |                    |

We reserve the right to make technical alterations without prior notice.

## Functional Wiring Diagrams

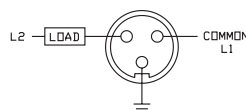



## Multibox® Minifast® Junction Boxes with LEDs, 3-pin

### Specifications

|                    |  |                     |                                      |
|--------------------|--|---------------------|--------------------------------------|
| <b>Housing:</b>    | Die cast aluminum alloy                                | <b>Temperature:</b> | -30 °C to +80 °C (-22 °F to +176 °F) |
| <b>Connectors:</b> | Nickel plated brass, oil resistant TPU contact carrier | <b>Protection:</b>  | IEC IP67                             |
| <b>Contacts:</b>   | Gold plated brass                                      |                     |                                      |

### Dimensions

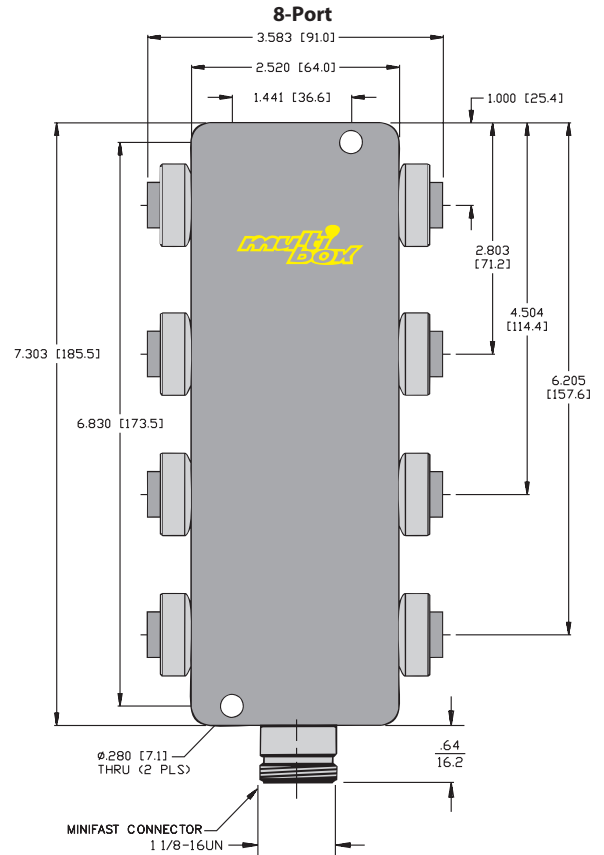
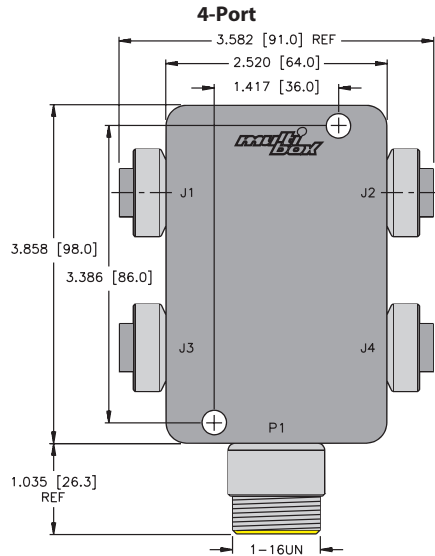

We reserve the right to make technical alterations without prior notice.

multibox®, minifast®

#### Notes

Clearance holes for 1/4-20 screws (2 places).  
All housings are 34 mm in height.

#### Pinout

| 3-pin Minifast | 7-pin Minifast | 12-pin Minifast |
|----------------|----------------|-----------------|
| Female         | Male           | Male            |
|                |                |                 |

# Junction Box Connectivity Products

## Multibox® Minifast® Junction Boxes, 4-pin

- 4, 6 and 8 Ports
- Integral Home Run Cable
- Simplifies Wiring Installations



### 4-Port, 250 VAC/300 VDC

| Application  | Specifications  | Pinout   |                                |  |                                | Part Number |
|--|---|--|--------------------------------|--|--------------------------------|-------------|
| 4-port J-box,<br>4-pin connectors,<br>Integral cable | 4 A/port, 9 A total<br>PVC cable, black,<br>6x18 AWG, foil shield<br>and 20 AWG drain | <u>Function</u><br>Common +V<br>Ground -V<br>J1 Load | <u>Color</u><br>WH<br>GN<br>RD | <u>Function</u><br>J2 Load<br>J3 Load<br>J4 Load | <u>Color</u><br>OG<br>BK<br>BU | 4 RKF 40-*M |

### 6-Port, 250 VAC/300 VDC

| Application  | Specifications  | Pinout  |                                      |   |                                      | Part Number |
|--|---|---|--------------------------------------|---|--------------------------------------|-------------|
| 6-port J-box,<br>4-pin connectors,<br>Integral cable | 4 A/port, 9 A total<br>PVC cable, black,<br>8x18 AWG, foil shield<br>and 20 AWG drain | <u>Function</u><br>Common +V<br>Ground -V<br>J1 Load<br>J2 Load | <u>Color</u><br>WH<br>GN<br>RD<br>OG | <u>Function</u><br>J3 Load<br>J4 Load<br>J5 Load<br>J6 Load | <u>Color</u><br>BK<br>BU<br>YE<br>BN | 6 RKF 40-*M |

### 8-Port, 250 VAC/300 VDC

| Application  | Specifications   | Pinout   |  |  |  | Part Number |
|--|--|--|--|--|--|-------------|
| 8-port J-box,<br>4-pin connectors,<br>Integral cable | 4 A/port, 9 A total<br>PVC cable, black,<br>10x18 AWG, foil shield<br>and 20 AWG drain | <u>Function</u><br>Common +V<br>Ground -V<br>J1 Load<br>J2 Load<br>J3 Load | <u>Color</u><br>WH<br>GN<br>RD<br>VT<br>BK | <u>Function</u><br>J4 Load<br>J5 Load<br>J6 Load<br>J7 Load<br>J8 Load | <u>Color</u><br>BU<br>GY<br>YE<br>OG<br>BN | 8 RKF 40-*M |

We reserve the right to make technical alterations without prior notice.

### Functional Wiring Diagrams

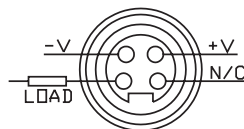

Power (pin 1 and pin 3) are wired parallel internally.  
Load (pin 4) is individual output. Pin 2 is not used.

### Specifications

|                    |  |                          |   |
|--------------------|--|--------------------------|---|
| <b>Housing:</b>    | Die cast aluminum alloy                                | <b>Temperature:</b>      | -30 °C to +80 °C (-22 °F to +176 °F)  |
| <b>Connectors:</b> | Nickel plated brass, oil resistant TPU contact carrier | <b>Protection Class:</b> | IEC IP67  |
| <b>Contacts:</b>   | Gold plated brass                                      | <b>Cable Length:</b>     | Standard cable length is 6 meters. Other lengths available by request - consult factory |
| <b>Cable:</b>      | See table for specifications                           |                          |   |

### Dimensions

We reserve the right to make technical alterations without prior notice.

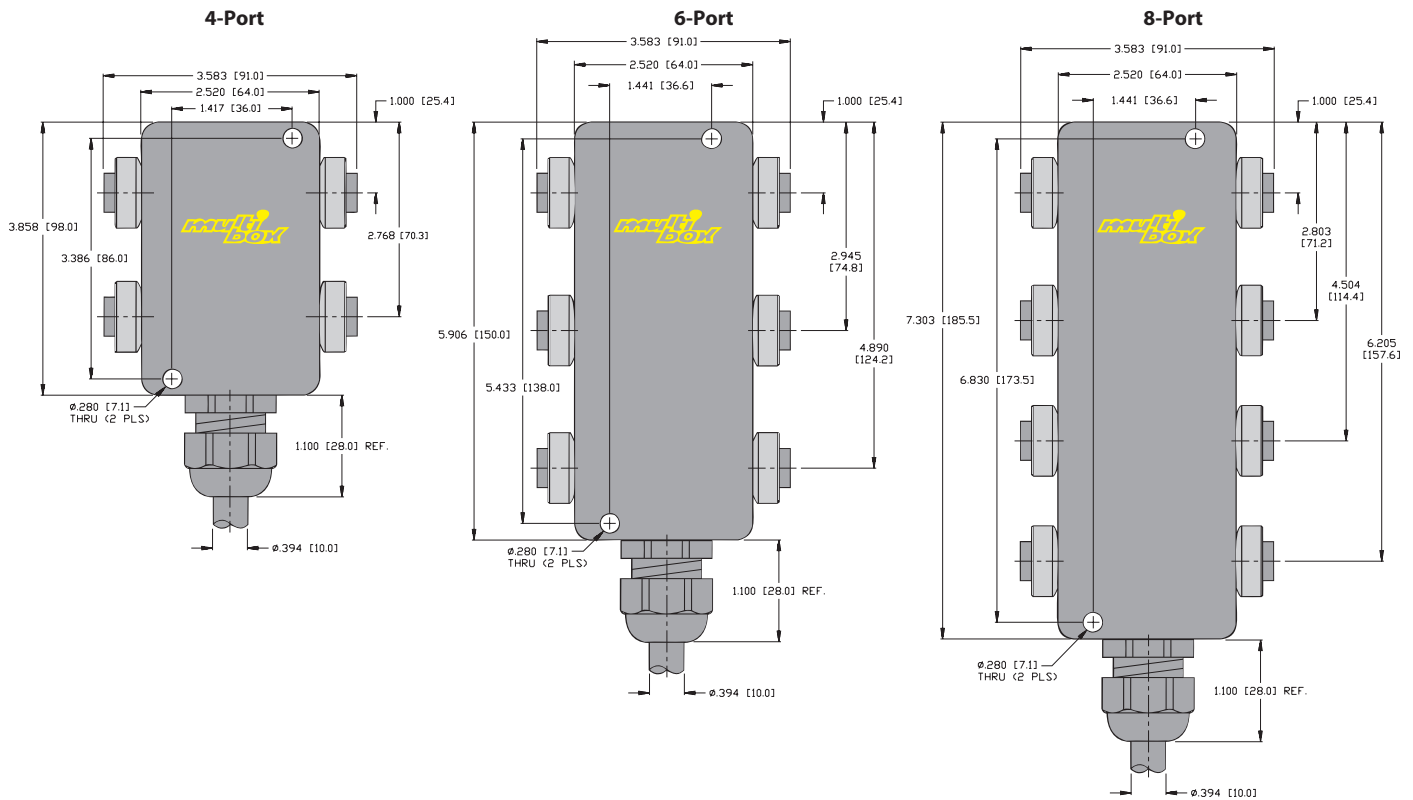

multibox®, minifast®

#### Notes

Clearance holes for 1/4-20 screws (2 places).  
All housings are 34 mm in height.

#### Pinout

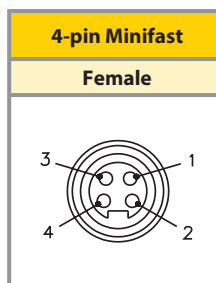

# Junction Box Connectivity Products

## Multibox® Minifast® Junction Boxes, 4-pin

- 4, 6 and 8 Ports
- Quick Disconnect Minifast Connector
- Simplifies Wiring Installations



### 4-Port, 250 VAC / 300 VDC

| Application   | Specifications   | Pinout   |  |  |  | Part Number     |
|---|--|--|--|--|--|-----------------|
| 4-port J-box<br>4-pin connectors,<br>Minifast connector | 4 A/port<br>8 A total<br>6-pin Minifast connector<br>6 conductors. Mates with<br>RKM 66-*M | <u>Function</u><br>Common +V<br>Ground -V<br>J1 Load | <u>Pin/Color</u><br>1 / WH<br>3 / GN<br>2 / RD | <u>Function</u><br>J2 Load<br>J3 Load<br>J4 Load | <u>Pin/Color</u><br>4 / OG<br>5 / BK<br>6 / BU | 4 RKF 40-RSF6B6 |

### 6-Port, 250 VAC / 300 VDC

| Application   | Specifications   | Pinout  |  |   |  | Part Number    |
|---|--|---|--|---|--|----------------|
| 6-port J-box<br>4-pin connectors,<br>Minifast connector | 4 A/port<br>8 A total<br>8-pin Minifast connector<br>8 conductors. Mates with<br>RKM 86-*M | <u>Function</u><br>Common +V<br>Ground -V<br>J1 Load<br>J2 Load | <u>Pin/Color</u><br>5 / WH<br>7 / GN<br>6 / RD<br>1 / OG | <u>Function</u><br>J3 Load<br>J4 Load<br>J5 Load<br>J6 Load | <u>Pin/Color</u><br>4 / BK<br>2 / BU<br>3 / WH / BK<br>8 / RD / BK | 6 RKF 40-RSF80 |

### 8-Port, 250 VAC / 300 VDC

| Application   | Specifications  | Pinout   |   |   |  | Part Number     |
|---|---|--|---|---|--|-----------------|
| 8-port J-box<br>4-pin connectors,<br>Minifast connector | 4 A/port<br>7 A total<br>10-pin Minifast connector<br>10 conductors. Mates with<br>RKM 106-*M | <u>Function</u><br>Common +V<br>Ground -V<br>J1 Load<br>J2 Load<br>J3 Load | <u>Pin/Color</u><br>10 / WH<br>8 / GN<br>7 / RD<br>1 / OG<br>9 / BK | <u>Function</u><br>J4 Load (L2)<br>J5 Load (L2)<br>J6 Load (L2)<br>J7 Load (L2)<br>J8 Load (L2) | <u>Pin/Color</u><br>2 / BU<br>3 / WH / BK<br>4 / RD / BK<br>5 / GN / BK<br>6 / OG / BK | 8 RKF 40-RSF100 |

We reserve the right to make technical alterations without prior notice.

## Functional Wiring Diagrams



Power (pin 1 and pin 3) are wired parallel internally.  
Load (pin 4) is individual output. Pin 2 is not used.

### Specifications

|                    |  |                     |                                      |
|--------------------|--|---------------------|--------------------------------------|
| <b>Housing:</b>    | Die cast aluminum alloy                                | <b>Temperature:</b> | -30 °C to +80 °C (-22 °F to +176 °F) |
| <b>Connectors:</b> | Nickel plated brass, oil resistant TPU contact carrier | <b>Protection:</b>  | IEC IP67                             |
| <b>Contacts:</b>   | Gold plated brass                                      |                     |                                      |

### Dimensions

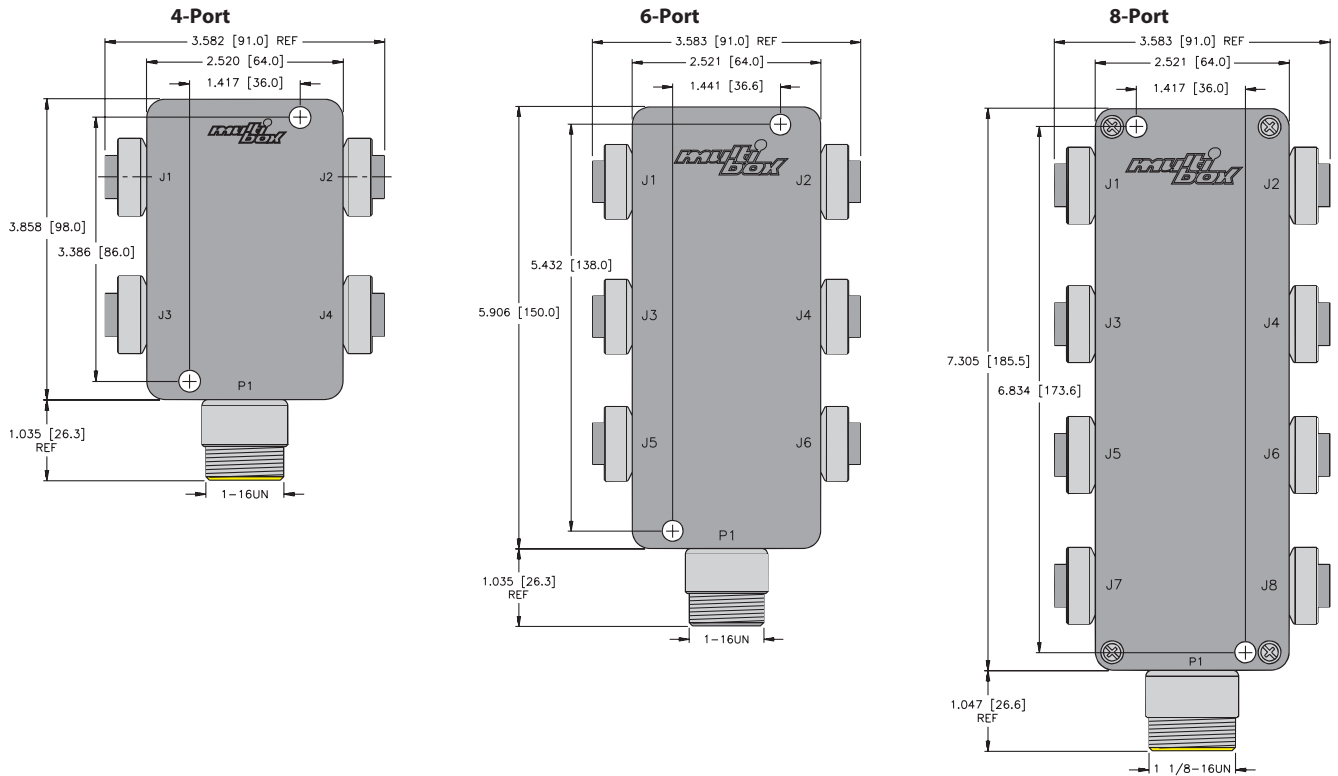

We reserve the right to make technical alterations without prior notice.

multibox®, minifast®

#### Notes

Clearance holes for 1/4-20 screws (2 places).  
All housings are 34 mm in height.

#### Pinout

| 4-pin Minifast | 6-pin Minifast | 8-pin Minifast | 10-pin Minifast |
|----------------|----------------|----------------|-----------------|
| Female         | Male           | Male           | Male            |
|                |                |                |                 |

# Junction Box Connectivity Products

## Multibox® Minifast® Junction Boxes, Series Wired

- 4, 6 and 8 Ports
- Minifast Quick Disconnect or Integral Home Run Cable
- Simplifies Wiring Installations
- Series Wired for Logic Wiring and or NOR Junction



### 4-Port, 250 VAC/300 VDC

| Application  | Specifications   | Pinout  |  | Part Number     |
|--|--|---|--|-----------------|
| 4 port J-box<br>Series wired<br>Integral cable     | 4 A/port, 4 A total<br>PVC cable, yellow, 3/16 AWG                                     | <u>Function</u><br>Common (L1)<br>Ground<br>Load (L2) | <u>Color</u><br>WH<br>GN<br>BK                 | 4 RKF 301-*M    |
| 4 port J-box<br>Series wired<br>Minifast connector | 4 A/port, 4 A total<br>3-pin Minifast connector,<br>3 conductors. Mates with RKM 36-*M | <u>Function</u><br>Common (L1)<br>Ground<br>Load (L2) | <u>Pin/Color</u><br>3 / WH<br>1 / GN<br>2 / BK | 4 RKF 301-B1131 |

### 6-Port, 250 VAC/300 VDC

| Application  | Specifications   | Pinout  |  | Part Number     |
|--|--|---|--|-----------------|
| 6 port J-box<br>Series wired<br>Integral cable     | 4 A/port, 4 A total<br>PVC cable, yellow, 3/16 AWG                                     | <u>Function</u><br>Common (L1)<br>Ground<br>Load (L2) | <u>Color</u><br>WH<br>GN<br>BK                 | 6 RKF 301-*M    |
| 6 port J-box<br>Series wired<br>Minifast connector | 4 A/port, 4 A total<br>3-pin Minifast connector,<br>3 conductors. Mates with RKM 36-*M | <u>Function</u><br>Common (L1)<br>Ground<br>Load (L2) | <u>Pin/Color</u><br>3 / WH<br>1 / GN<br>2 / BK | 6 RKF 301-B1131 |

### 8-Port, 250 VAC/300 VDC

| Application  | Specifications   | Pinout  |  | Part Number     |
|--|--|---|--|-----------------|
| 8 port J-box<br>Series wired<br>Integral cable     | 4 A/port, 4 A total<br>PVC cable, yellow, 3x16 AWG                                     | <u>Function</u><br>Common (L1)<br>Ground<br>Load (L2) | <u>Color</u><br>WH<br>GN<br>BK                 | 8 RKF 301-*M    |
| 8 port J-box<br>Series wired<br>Minifast connector | 4 A/port, 4 A total<br>3-pin Minifast connector,<br>3 conductors. Mates with RKM 36-*M | <u>Function</u><br>Common (L1)<br>Ground<br>Load (L2) | <u>Pin/Color</u><br>3 / WH<br>1 / GN<br>2 / BK | 8 RKF 301-B1131 |

We reserve the right to make technical alterations without prior notice.

| Housing Style | Part Number       | Features                             | Pinout |
|---------------|-------------------|--------------------------------------|--------|
|               | <b>RSM 30-J23</b> | Jumper plug for use on unused inputs |        |

### Functional Wiring Diagrams

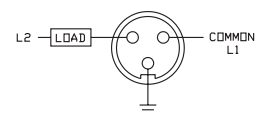

### Specifications

|                    |  |                      |   |
|--------------------|--|----------------------|---|
| <b>Housing:</b>    | Die cast aluminum alloy                                | <b>Temperature:</b>  | -30 °C to +80 °C (-22 °F to +176 °F)  |
| <b>Connectors:</b> | Nickel plated brass, oil resistant TPU contact carrier | <b>Protection:</b>   | IEC IP67  |
| <b>Contacts:</b>   | Gold plated brass                                      | <b>Cable Length:</b> | Standard cable length is 6 meters. Other lengths available by request - consult factory |
| <b>Cable:</b>      | See table for specifications                           |                      |   |

### Dimensions

We reserve the right to make technical alterations without prior notice.

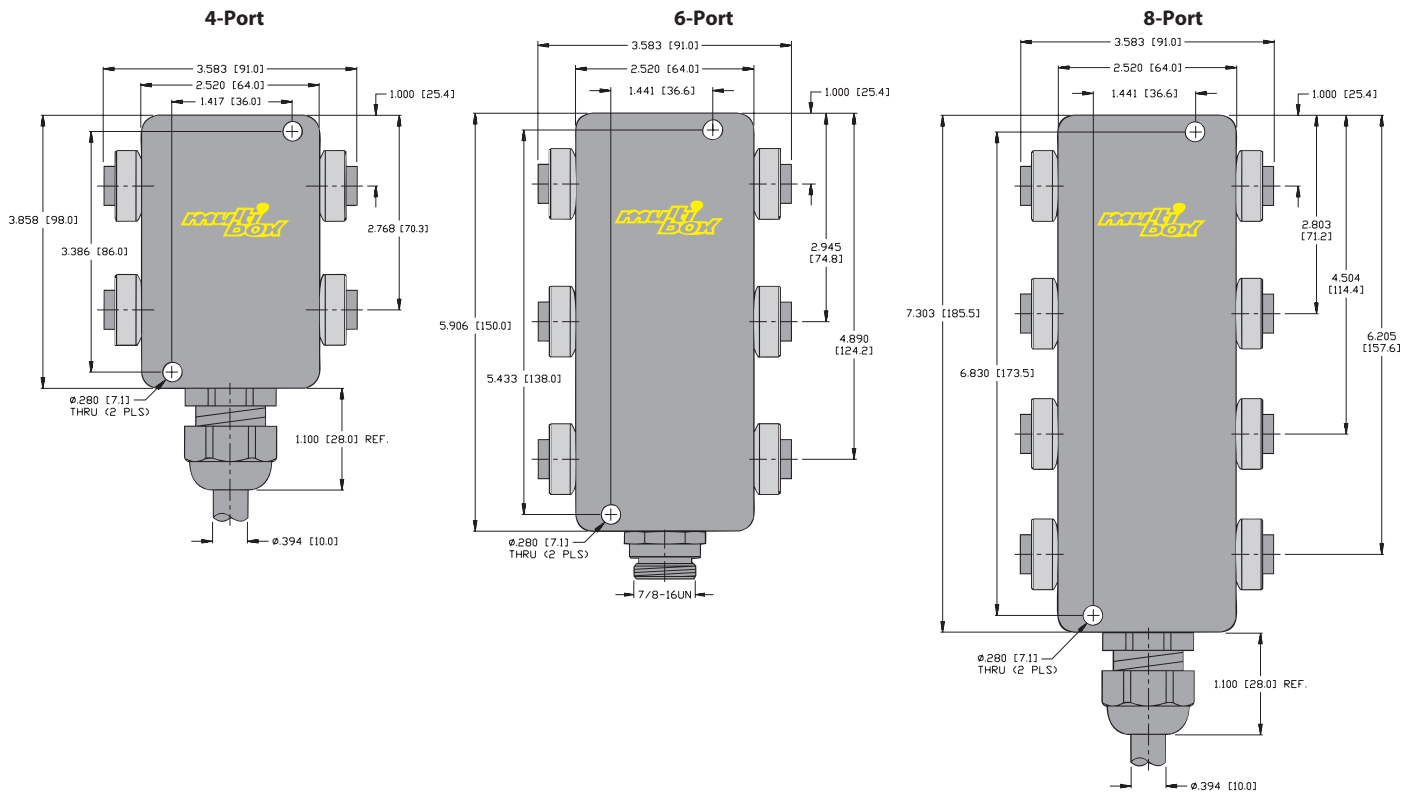

multibox®, minifast®

#### Notes

Clearance holes for 1/4-20 screws (2 places).  
 All housings are 34 mm in height.

#### Pinout

| 3-pin Minifast |      |
|----------------|------|
| Female         | Male |
|                |      |

# Junction Box Connectivity Products

## Multibox® Microfast® Junction Boxes

- 4, 6 and 8 Ports
- For AC Sensors
- M23 Quick Disconnect, Minifast® Connector or Integral Home Run Cable
- Simplifies Wiring Installations



### 4-Port, 250 VAC / 300 VDC

| Application  | Specifications  | Pinout   |  |   |  | Part Number   |
|--|---|--|--|---|--|---------------|
| 4-port J-box<br>Standard wiring<br>Integral cable        | 4 A/port, 9 A total<br>PVC cable, black, 6x18 AWG,<br>foil shield and 20 AWG drain            | <u>Function</u><br>Common (L1)<br>Ground<br>J1 Load (L2) | <u>Color</u><br>WH<br>GN<br>RD                 | <u>Function</u><br>J2 Load (L2)<br>J3 Load (L2)<br>J4 Load (L2) | <u>Color</u><br>OG<br>BK<br>BU                 | VBKB 40-*     |
| 4-port J-box<br>Standard wiring,<br>Multifast® connector | 4 A/port, 7 A total<br>12-pin Multifast connector,<br>6 conductors. Mates with<br>CKRM 12-6-* | <u>Function</u><br>Common (L1)<br>Ground<br>J1 Load (L2) | <u>Pin/Color</u><br>5 / WH<br>7 / GN<br>6 / RD | <u>Function</u><br>J2 Load (L2)<br>J3 Load (L2)<br>J4 Load (L2) | <u>Pin/Color</u><br>1 / OG<br>4 / BK<br>2 / BU | VBKB 40-CS12  |
| 4-port J-box<br>Standard wiring<br>Minifast connector    | 4 A/port, 9 A total<br>6-pin Minifast connector,<br>6 conductors. Mates with<br>RKM 66-*M     | <u>Function</u><br>Common (L1)<br>Ground<br>J1 Load (L2) | <u>Pin/Color</u><br>1 / WH<br>3 / GN<br>2 / RD | <u>Function</u><br>J2 Load (L2)<br>J3 Load (L2)<br>J4 Load (L2) | <u>Pin/Color</u><br>4 / OG<br>5 / BK<br>6 / BU | VBKB 40-B1161 |

### 6-Port, 250 VAC / 300 VDC

| Application  | Specifications  | Pinout   |  |   |  | Part Number  |
|--|---|--|--|---|--|--------------|
| 6-port J-box<br>Standard wiring<br>Integral cable      | 4 A/port, 9 A total<br>PVC cable, black, 8x18 AWG,<br>foil shield and 20 AWG drain            | <u>Function</u><br>Common (L1)<br>Ground<br>J1 Load (L2)<br>J2 Load (L2) | <u>Color</u><br>WH<br>GN<br>RD<br>OG                     | <u>Function</u><br>J3 Load (L2)<br>J4 Load (L2)<br>J5 Load (L2)<br>J6 Load (L2) | <u>Color</u><br>BK<br>BU<br>YE<br>BN                     | VBKB 60-*    |
| 6-port J-box<br>Standard wiring<br>Multifast connector | 4 A/port, 7 A total<br>12-pin Multifast connector,<br>8 conductors. Mates with<br>CKRM 12-8-* | <u>Function</u><br>Common (L1)<br>Ground<br>J1 Load (L2)<br>J2 Load (L2) | <u>Pin/Color</u><br>5 / WH<br>7 / GN<br>6 / RD<br>1 / OG | <u>Function</u><br>J3 Load (L2)<br>J4 Load (L2)<br>J5 Load (L2)<br>J6 Load (L2) | <u>Pin/Color</u><br>4 / BK<br>2 / BU<br>3 / YE<br>8 / BN | VBKB 60-CS12 |

### 8-Port, 250 VAC / 300 VDC

| Application  | Specifications  | Pinout   |  |   |   | Part Number  |
|--|---|--|--|---|---|--------------|
| 8-port J-box<br>Standard wiring,<br>Integral cable     | 4 A/port, 9 A total<br>PVC cable, black, 10x18 AWG,<br>foil shield and 20 AWG drain             | <u>Function</u><br>Common (L1)<br>Ground<br>J1 Load (L2)<br>J2 Load (L2)<br>J3 Load (L2) | <u>Color</u><br>WH<br>GN<br>RD<br>VT<br>BK                         | <u>Function</u><br>J4 Load (L2)<br>J5 Load (L2)<br>J6 Load (L2)<br>J7 Load (L2)<br>J8 Load (L2) | <u>Color</u><br>BU<br>GY<br>YE<br>OG<br>BN                          | VBKB 80-*    |
| 8-port J-box<br>Standard wiring<br>Multifast connector | 4 A/port, 7 A total<br>12-pin Multifast connector,<br>10 conductors. Mates with<br>CKRM 12-10-* | <u>Function</u><br>Common (L1)<br>Ground<br>J1 Load (L2)<br>J2 Load (L2)<br>J3 Load (L2) | <u>Pin/Color</u><br>5 / WH<br>7 / GN<br>6 / RD<br>1 / VT<br>4 / BK | <u>Function</u><br>J4 Load (L2)<br>J5 Load (L2)<br>J6 Load (L2)<br>J7 Load (L2)<br>J8 Load (L2) | <u>Pin/Color</u><br>2 / BU<br>3 / GY<br>8 / YE<br>9 / OG<br>10 / BN | VBKB 80-CS12 |

\* Length in meters.

We reserve the right to make technical alterations without prior notice.



## Multibox® Microfast® Junction Boxes

### Specifications

|                        |                     |                      |   |
|------------------------|---------------------|----------------------|---|
| <b>Housing:</b>        | Nylon               | <b>Temperature:</b>  | -30 °C to +80 °C (-22 °F to +176 °F)  |
| <b>Connectors:</b>     | Nylon (Microfast)   | <b>Protection:</b>   | IEC IP67  |
| <b>Contacts:</b>       | Gold plated brass   | <b>Cable Length:</b> | Standard cable length is nominal 5 meters. Other lengths available by request - consult factory |
| <b>Thread Inserts:</b> | Nickel plated brass | <b>Accessories:</b>  | (2) SB-CC closure caps and a VZ1 label kit included   |
| <b>Cable:</b>          | See table           |                      |   |

### Dimensions

We reserve the right to make technical alterations without prior notice.

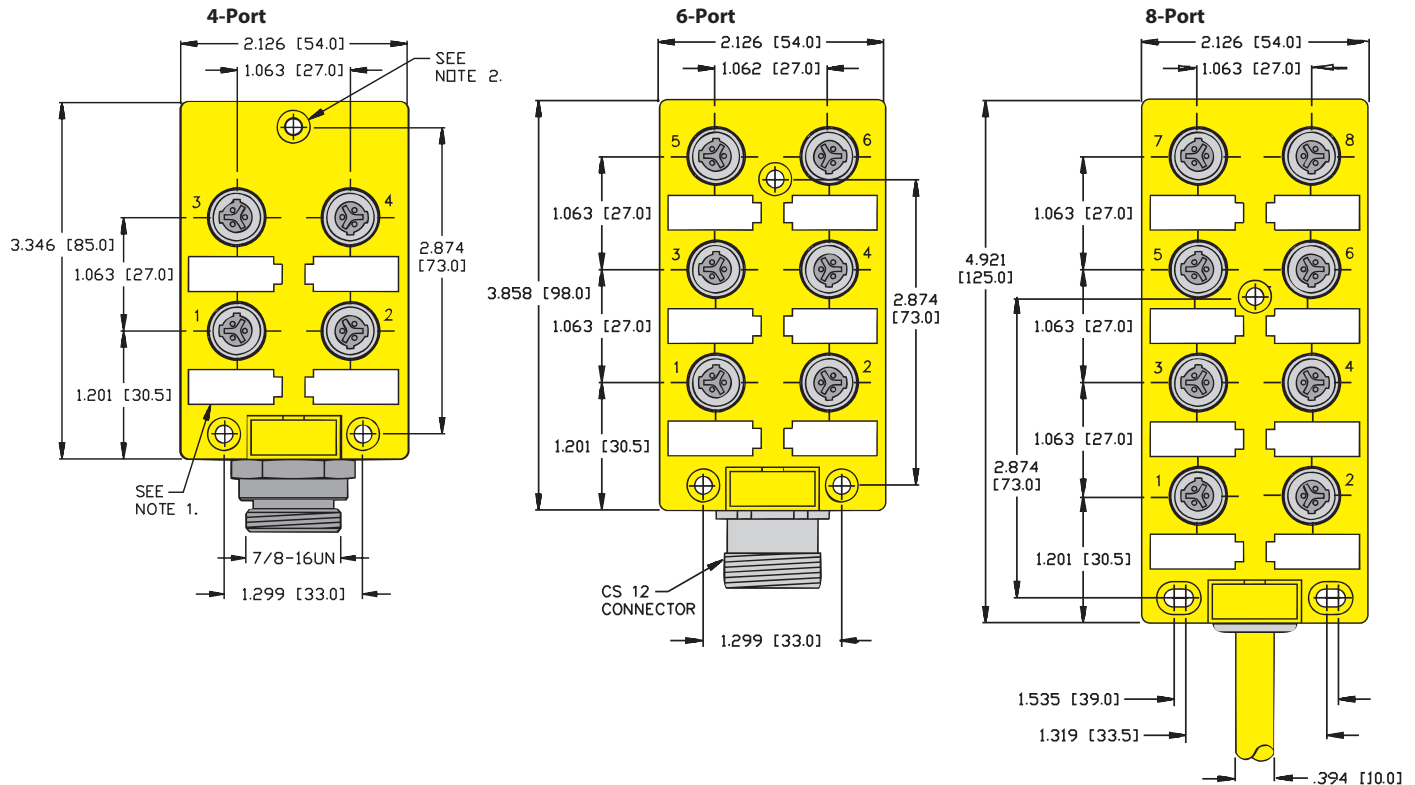

multibox®, microfast®

#### Notes

- Removable labels included.
- Clearance holes for #8 screws (3 places).
- Housings with integral cable: 23 mm in thickness.
- Housings with quick disconnect: 33 mm thickness.

#### Pinout

| 3-pin Microfast | 6-pin Minifast® | 12-pin Multifast® |
|-----------------|-----------------|-------------------|
| Female          | Male            | Male              |
|                 |                 |                   |

#### Functional Wiring Diagrams



# Junction Box Connectivity Products

## Multibox® Microfast® Junction Boxes with LEDs

- 4 and 8 Ports
- For AC Sensors
- Simplifies Wiring Installations
- M23 Quick Disconnect or Integral Home Run Cable
- LEDs for Power and Signal



### 4-Port, 40-120 VAC

| Application   | Specifications  | Pinout          |                  |                 |                  | Part Number      |
|---|---|-----------------|------------------|-----------------|------------------|------------------|
| 4 port J-box<br>Standard wiring<br>Integral cable       | 4 A/port, 9 A total<br>PVC cable, black, 7x18 AWG,<br>foil shield and 20 AWG drain            | <u>Function</u> | <u>Color</u>     | <u>Function</u> | <u>Color</u>     | VBKB 40-X5-*     |
|   |   | Common (L1)     | WH               | J2 Load (L2)    | OG               |                  |
|   |   | LED Power (L2)  | WH / BK          | J3 Load (L2)    | BK               |                  |
|   |   | Ground          | GN               | J4 Load (L2)    | BU               |                  |
|   |   | J1 Load (L2)    | RD               |                 |                  |                  |
| 4 port J-box<br>Standard wiring<br>Multifast® connector | 4 A/port, 7 A total<br>12-pin Multifast connector,<br>7 conductors. Mates with<br>CKBM 12-7-* | <u>Function</u> | <u>Pin/Color</u> | <u>Function</u> | <u>Pin/Color</u> | VBKB 40-X5-CS12v |
|   |   | Common (L1)     | 3 / WH           | J2 Load (L2)    | 5 / OG           |                  |
|   |   | LED Power (L2)  | 1 / WH/BK        | J3 Load (L2)    | 2 / BK           |                  |
|   |   | Ground          | 7 / GN           | J4 Load (L2)    | 6 / BU           |                  |
|   |   | J1 Load (L2)    | 4 / RD           |                 |                  |                  |

### 8-Port, 40-120 VAC

| Application  | Specifications  | Pinout          |                  |                 |                  | Part Number     |
|--|---|-----------------|------------------|-----------------|------------------|-----------------|
| 8 port J-box<br>Standard wiring<br>Integral cable      | 4 A/port, 9 A total<br>PVC cable, black, 11x18 AWG,<br>foil shield and 20 AWG drain             | <u>Function</u> | <u>Color</u>     | <u>Function</u> | <u>Color</u>     | VBKB 80-X9-*    |
|  |   | Common (L1)     | WH               | J4 Load (L2)    | BU               |                 |
|  |   | LED Power (L2)  | BU / BK          | J5 Load (L2)    | WH / BK          |                 |
|  |   | Ground          | GN               | J6 Load (L2)    | RD / BK          |                 |
|  |   | J1 Load (L2)    | RD               | J7 Load (L2)    | GN / BK          |                 |
|  |   | J2 Load (L2)    | OG               | J8 Load (L2)    | OG / BK          |                 |
| 8 port J-box<br>Standard wiring<br>Multifast connector | 4 A/port, 7 A total<br>12-pin Multifast connector,<br>11 conductors. Mates with<br>CKBM 12-11-* | <u>Function</u> | <u>Pin/Color</u> | <u>Function</u> | <u>Pin/Color</u> | VBKB 80-X9-CS12 |
|  |   | Common (L1)     | 11 / WH          | J4 Load (L2)    | 2 / BU           |                 |
|  |   | LED Power (L2)  | 7 / BU/BK        | J5 Load (L2)    | 3 / WH / BK      |                 |
|  |   | Ground          | 9 / GN           | J6 Load (L2)    | 4 / RD / BK      |                 |
|  |   | J1 Load (L2)    | 10 / RD          | J7 Load (L2)    | 5 / GN / BK      |                 |
|  |   | J2 Load (L2)    | 1 / OG           | J8 Load (L2)    | 6 / OG / BK      |                 |
|  |   | J3 Load (L2)    | 12 / BK          |                 |                  |                 |
|  |   |                 |                  |                 |                  |                 |

We reserve the right to make technical alterations without prior notice.

### Functional Wiring Diagrams

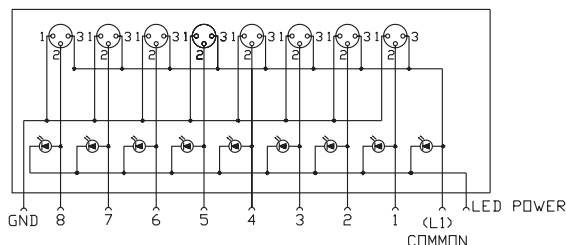
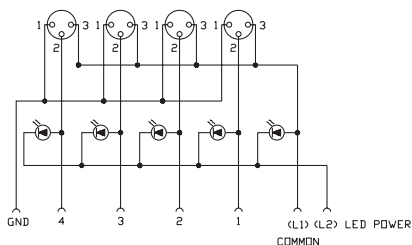

## Multibox® Microfast® Junction Boxes with LEDs

### Specifications

|                        |                     |                      |   |
|------------------------|---------------------|----------------------|---|
| <b>Housing:</b>        | Nylon               | <b>Temperature:</b>  | -30 °C to +80 °C (-22 °F to +176 °F)  |
| <b>Connectors:</b>     | Nylon (Microfast)   | <b>Protection:</b>   | IEC IP67  |
| <b>Contacts:</b>       | Gold plated brass   | <b>Cable Length:</b> | Standard cable length is nominal 5 meters. Other lengths available by request - consult factory |
| <b>Thread Inserts:</b> | Nickel plated brass | <b>Accessories:</b>  | (2) SB-CC closure caps and a VZ1 label kit included   |
| <b>Cable:</b>          | See table           |                      |   |

### Dimensions

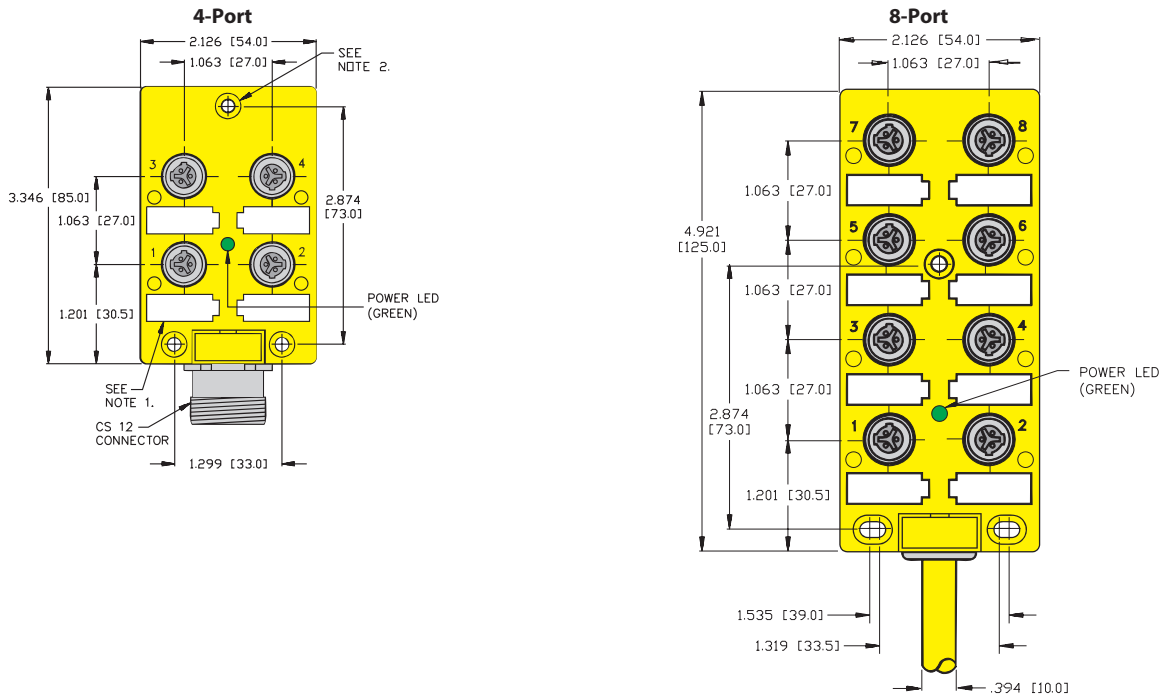

We reserve the right to make technical alterations without prior notice.

multibox®, microfast®

#### Notes

- Removable labels included.
- Clearance holes for #8 screws (3 places).
- Housings with integral cable: 23 mm in thickness.
- Housings with quick disconnect: 33 mm thickness.
- Green LED = Power on (center position).
- Yellow LED = Signal (outer position).

#### Pinout

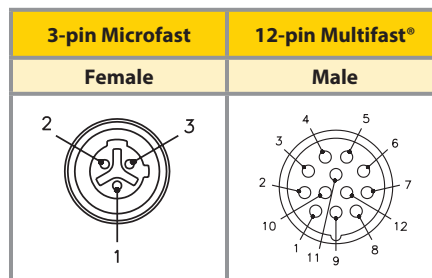

# Junction Box Connectivity Products

## Accessories

| Drawing | Part Number    | Features   |
|---------|----------------|--|
|         | <b>RKF-MC</b>  | Nickel plated brass, 7/8-16 UN threads, No lanyard, nitrile gasket, mates to male cordsets, receptacles, or junction box   |
|         | <b>RKFV-MC</b> | Stainless Steel, 7/8-16 UN threads, No lanyard, nitrile gasket, mates to male cordsets, receptacles, or junction box       |
|         | <b>RSF-MC</b>  | Nickel plated brass, 7/8-16 UN threads, No lanyard, nitrile gasket, mates to female cordsets, receptacles, or junction box |
|         | <b>RSFV-MC</b> | Stainless Steel, 7/8-16 UN threads, No lanyard, nitrile gasket, mates to female cordsets, receptacles, or junction box     |
|         | <b>RSFK-MC</b> | Nylon 7/8-16 UN threads, No lanyard, nitrile gasket, mates to female cordsets, receptacles, or junction box                |
|         | <b>VZ 1</b>    | Nylon, 8 white labels, 8x20 mm each, snap-in labels for Eurofast® and Microfast® junction boxes, valve plugs               |
|         | <b>VZ 12</b>   | Nylon, 40 white labels, 9x20 mm each, snap-in labels for Eurofast junction boxes, valve plugs                              |

We reserve the right to make technical alterations without prior notice.

| Drawing | Part Number       | Features   | Pinout |
|---------|-------------------|--|--------|
|         | <b>RSM 30-J23</b> | Minifast®, 7/8-16 UN thread, 300 V 80 °C, jumper plug for use on unused inputs for series wired junction boxes |        |

|                         |            |
|-------------------------|------------|
| <b>Part Number Keys</b> | <b>T3</b>  |
| <b>Cordsets</b>         | <b>T4</b>  |
| <b>Splitters</b>        | <b>T40</b> |
| <b>Field Wireables</b>  | <b>T42</b> |

## Features

- Environmentally protected electrical junction for use with hydraulic and pneumatic solenoid valves
- Available in A, B, I and C designs
- Options for wiring with LED, MOV or diode
- Provides rapid change out

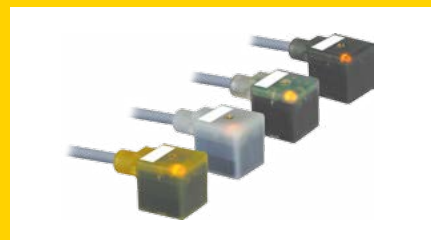

# Valve Plug Connectivity

## Valve Connector Products

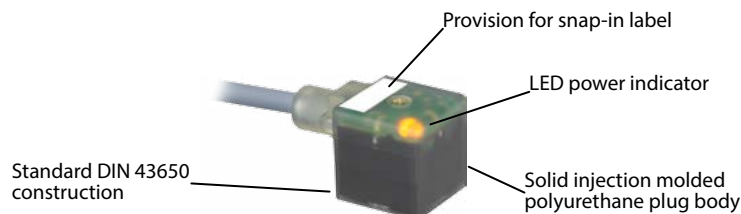

### Cable Styles

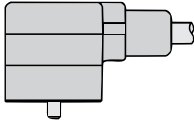
|   |  |            |
|---|--|------------|
|  | <b>Type "A" (18 mm)</b><br>Straight Wired, Indicator LED, Indicator LED and MOV, Indicator LED and Diode - DC  | <b>T4</b>  |
|   | <b>Type "A" (18 mm)</b> 3 Conductors + Ground<br>Straight Wired, Indicator LED, Indicator LED and MOV          | <b>T10</b> |
|   | <b>Type "B" (10 mm)</b><br>Straight Wired, Indicator LED, Indicator LED and MOV, Indicator LED and Diode - DC  | <b>T14</b> |
|   | <b>Type "I" (11 mm)</b><br>Straight Wired, Indicator LED, Indicator LED and MOV, Indicator LED and Diode - DC  | <b>T20</b> |
|   | <b>Type "C" (8 mm)</b><br>Straight Wired, Indicator LED, Indicator LED and MOV, Indicator LED and Diode - DC   | <b>T26</b> |
|   | <b>Type "C" (9.4 mm)</b><br>Straight Wired, Indicator LED, Indicator LED and MOV, Indicator LED and Diode - DC | <b>T32</b> |

### Extension Styles

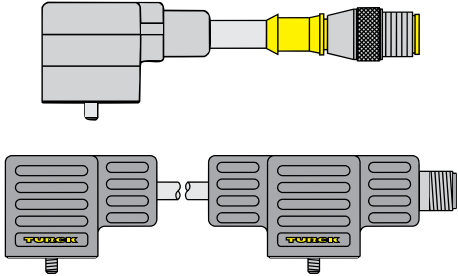
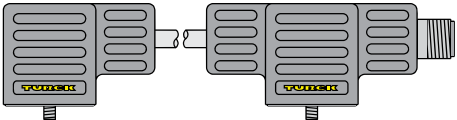
|  |  |            |
|--|--|------------|
| <br> | <b>Type "A" (18 mm)</b> with Eurofast®, Picofast®, Minifast® and Microfast® Connectors | <b>T6</b>  |
|  | <b>Type "A" (18 mm)</b> 3 Conductors + Ground with Eurofast Connector                  | <b>T12</b> |
|  | <b>Type "B" (10 mm)</b> with Eurofast, Picofast, Minifast and Microfast Connectors     | <b>T16</b> |
|  | <b>Type "I" (11 mm)</b> with Eurofast, Picofast, Minifast and Microfast Connectors     | <b>T22</b> |
|  | <b>Type "C" (8 mm)</b> with Eurofast, Picofast, Minifast and Microfast Connectors      | <b>T28</b> |
|  | <b>Type "C" (9.4 mm)</b> with Eurofast, Minifast and Microfast Connectors              | <b>T34</b> |
| Double Ended Valve Connectors - Consult factory for availability   |  |            |

### Integral Connector Styles

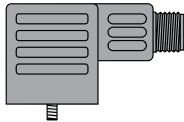
|   |  |            |
|---|--|------------|
|  | <b>Type "A" (18 mm)</b> with Eurofast and Picofast Connectors        | <b>T38</b> |
|   | <b>Type "B" (10 mm)</b> and Type "I" (11 mm) with Picofast Connector | <b>T38</b> |

### 2 Branch Molded Junctions with Valve Plugs

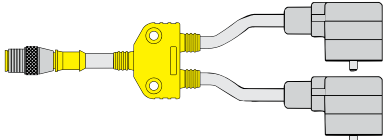
|   |                                    |            |
|---|------------------------------------|------------|
|  | <b>Types "A", "B", "I" and "C"</b> | <b>T40</b> |
|---|------------------------------------|------------|

### Field Wireable Styles

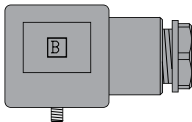
|   |                                    |            |
|---|------------------------------------|------------|
|  | <b>Types "A", "B", "I" and "C"</b> | <b>T42</b> |
|---|------------------------------------|------------|

We reserve the right to make technical alterations without prior notice.

## DIN 43650 Valve Cordset Part Number Key

Part Number Keys are to assist in IDENTIFICATION ONLY. Consult factory for catalog items not identified.

V A S    22 - F 653 - \*M    /S..

### DIN 43650 Valve Cordset

- T = cable exit on ground side
- V = cable exit opposite ground side
- H = cable exit opposite ground side on top of plug

### Housing Style

- A = type "A" (27.5 x 27.5 mm) 18 mm contact spacing
- B = type "B" (21.5 x 28 mm) 10 mm contact spacing
- I = type "I" (21.5 x 28 mm) 11 mm contact spacing
- C8 = type "C" (16 x 16 mm) 8 mm contact spacing
- C9 = type "C" (16 x 16 mm) 9.4 mm contact spacing

### Housing Color

- G = Translucent grey
- S = Translucent black
- Y = Translucent yellow
- (blank) = Clear

### Designator for Receptacle

- 2 = 2 conductors, 1 ground
- 21 = 2 conductors, ground not connected
- 22 = 2 conductors, 1 ground, ground contacts parallel wired
- 3 = 3 conductors, 1 ground
- 4 = 3 conductors, 1 ground, additional wire for dual LED

### Varieties

- /S .. = consult factory, special
- /S810 = Longer mounting screw

### Insertion Point of Extension Cable Second Prefix\*

- \* Valve connector listed first, other connector second
- Example: **VAS 22-F653-1M-RS 5.3T**

### Connection Type / Length in Meters

- (blank) = field wireable
- FS 5.3 = integrated M12 Eurofast® connector
- V1131 = integrated M8 Picofast® connector

### Number of Wires / AWG / Color Codes

- |                               |                                 |
|-------------------------------|---------------------------------|
| (blank) = adapter             | 644 = 4x18 AWG BN, BU, BK, WH   |
| W = field wireable connector  | 653 = 3x18 AWG BK, BK, GN/YE    |
| 544 = 4x18 AWG BN, WH, BK, BU | 654 = 3x18 AWG BN, BU, BK       |
| 587 = 3x24 AWG BN, BU, BK     | 658 = 3x18 AWG RD/BK, RD/WH, GN |
| 580 = 4x18 AWG BN, WH, BK, BU | 669 = 3x18 AWG BK, BK, GN/YE    |
| 642 = 3x24 AWG BN, BU, BK     |                                 |

### Wiring

- A = straight through . . . . 0-220 VAC/DC
- B = yellow LED . . . . . 24-48 VAC/DC
- C = yellow LED . . . . . 110-220 VAC/DC
- D = yellow LED/MOV. . . . 24-48 VAC/DC
- E = yellow LED/MOV. . . . 110-220 VAC/DC
- F = yellow LED/Diode . . . 24-48 VDC
- K = two color LED for change over to switch . . . . 24 VDC
- L = yellow LED . . . . . 24 VAC/DC
- M = yellow LED . . . . . 48 VAC/DC
- N = yellow LED . . . . . 110 VAC/DC
- P = yellow LED/MOV. . . . 24 VAC/DC
- R = yellow LED/MOV. . . . 48 VAC/DC
- red = switch open position
- green = switch closed position

# Valve Plug Connectivity

## Valve Connectors, Type "A" (18 mm)

- Available with PVC and TPU Jackets
- 18 and 24 AWG
- 2 Conductors + Ground, Ground Contacts Parallel Wired

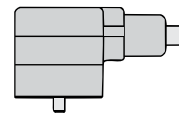

### "A" Style Valve Connectors, Standard Color Code

Type A

| Application       | Cable Specs   | Pinout                            | Voltage VAC/DC | Straight Wired | Indicator LED  | Indicator LED and MOV** | Indicator LED and Diode - DC only |
|-------------------|---|-----------------------------------|----------------|----------------|----------------|-------------------------|-----------------------------------|
| Standard duty PVC | 3/18 AWG, Grey PVC<br>105 °C<br>6.2 mm OD<br>Black Body | 1. BK 1<br>2. BK 2<br>Gnd - GN/YE | 0-220          | VAS 22-A653-*M | ----           | ----                    | ----                              |
|                   |   |                                   | 24-48          | ----           | VAS 22-B653-*M | VAS 22-D653-*M          | VAS 22-F653-*M                    |
|                   |   |                                   | 110-220        | ----           | VAS 22-C653-*M | VAS 22-E653-*M          | ----                              |
| Standard duty TPU | 3/18 AWG, Grey TPU<br>90 °C<br>6.0 mm OD<br>Black Body  | 1. BK 1<br>2. BK 2<br>Gnd - GN/YE | 0-220          | VAS 22-A669-*M | ----           | ----                    | ----                              |
|                   |   |                                   | 24-48          | ----           | VAS 22-B669-*M | VAS 22-D669-*M          | VAS 22-F669-*M                    |
|                   |   |                                   | 110-220        | ----           | VAS 22-C669-*M | VAS 22-E669-*M          | ----                              |

### "A" Style Valve Connectors, IEC Color Code

| Application        | Cable Specs   | Pinout                     | Voltage VAC/DC | Straight Wired | Indicator LED  | Indicator LED and MOV** | Indicator LED and Diode - DC only |
|--------------------|---|----------------------------|----------------|----------------|----------------|-------------------------|-----------------------------------|
| Small diameter PVC | 3/24 AWG, Yellow PVC<br>105 °C<br>4.4 mm OD<br>Black Body | 1. BN<br>2. BU<br>Gnd - BK | 0-220          | VAS 22-A642-*M | ----           | ----                    | ----                              |
|                    |   |                            | 24-48          | ----           | VAS 22-B642-*M | VAS 22-D642-*M          | VAS 22-F642-*M                    |
|                    |   |                            | 110-220        | ----           | VAS 22-C642-*M | VAS 22-E642-*M          | ----                              |
| Small diameter TPU | 3/24 AWG, Black TPU<br>90 °C<br>4.2 mm OD<br>Black Body   | 1. BN<br>2. BU<br>Gnd - BK | 0-220          | VAS 22-A587-*M | ----           | ----                    | ----                              |
|                    |   |                            | 24-48          | ----           | VAS 22-B587-*M | VAS 22-D587-*M          | VAS 22-F587-*M                    |
|                    |   |                            | 110-220        | ----           | VAS 22-C587-*M | VAS 22-E587-*M          | ----                              |

\* Length in meters.

We reserve the right to make technical alterations without prior notice.

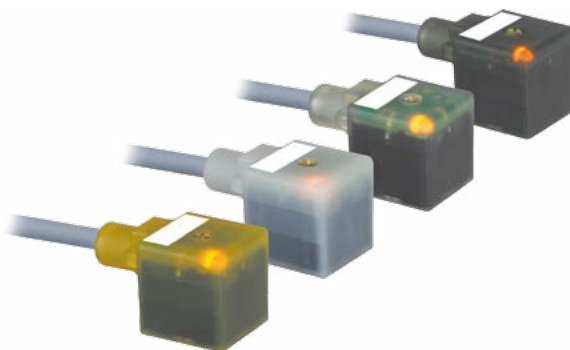



## Valve Connectors, Type "A" (18 mm)

### Specifications

- Connectors:** Oil resistant polyurethane body material, Nylon contact carrier.
- Contacts:** Silver plated copper alloy.
- Cable:** See table.
- Cable Length:** Standard cable lengths are nominal 2, 5 and 10 meters. Other lengths available by request - consult factory.
- Protection Class:** NEMA 1, 3, 4, 6P and IEC IP 67 when connected and secured.

**Options:** Grey connector body available (special order), change part number VAS .. or VAY .. to VAG ..  
For other combinations or options, consult factory.

### Dimensions

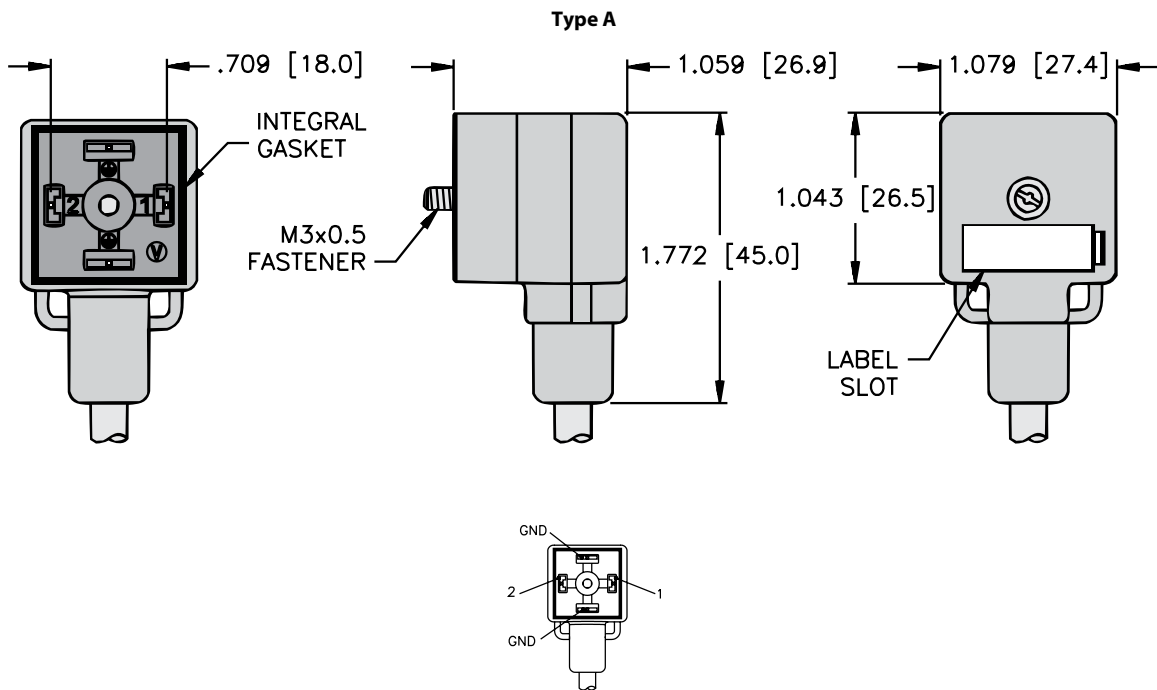

We reserve the right to make technical alterations without prior notice.

### Wiring Diagrams

| Straight Wired (A) | Indicator LED (B,C) | Indicator LED and MOV (D,E) | Indicator LED and Diode - DC (F) |
|--------------------|---------------------|-----------------------------|----------------------------------|
|                    |                     |                             |                                  |

# Valve Plug Connectivity

## Valve Connectors, Type "A" (18 mm) Extensions

- Eurofast® and Picofast® Connectors
- Wired for Use with Junction Box
- 2 Conductors + Ground, (Eurofast), Ground Contacts Parallel Wired

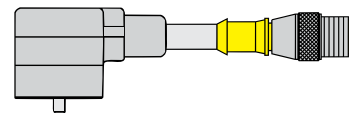

### "A" Style Valve Connectors, Eurofast Extension

Eurofast Extension

| Application       | Cable Specs                                 | Voltage VAC/DC | Straight Wired         | Indicator LED          | Indicator LED and MOV  | Indicator LED and Diode - DC only |
|-------------------|---|----------------|------------------------|------------------------|------------------------|-----------------------------------|
| Standard duty PVC | 3/18 AWG<br>Grey PVC<br>105 °C<br>6.2 mm OD | 0-220          | VAS 22-A653-*M-RS 5.3T | ----                   | ----                   | ----                              |
|                   |   | 24-48          | ----                   | VAS 22-B653-*M-RS 5.3T | VAS 22-D653-*M-RS 5.3T | VAS 22-F653-*M-RS 5.3T            |
|                   |   | 110-220        | ----                   | VAS 22-C653-*M-RS 5.3T | VAS 22-E653-*M-RS 5.3T | ----                              |
| Standard duty TPU | 3/18 AWG<br>Grey TPU<br>90 °C<br>6.0 mm OD  | 0-220          | VAS 22-A669-*M-RS 5.3T | ----                   | ----                   | ----                              |
|                   |   | 24-48          | ----                   | VAS 22-B669-*M-RS 5.3T | VAS 22-D669-*M-RS 5.3T | VAS 22-F669-*M-RS 5.3T            |
|                   |   | 110-220        | ----                   | VAS 22-C669-*M-RS 5.3T | VAS 22-E669-*M-RS 5.3T | ----                              |

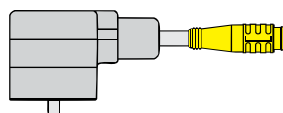

Picofast Snap Extension

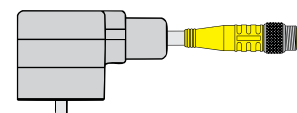

Picofast Threaded Extension

### "A" Style Valve Connectors, Picofast Extension

| Application                   | Cable Specs                                   | Voltage VAC/DC | Straight Wired        | Indicator LED         | Indicator LED and MOV | Indicator LED and Diode - DC only |
|-------------------------------|---|----------------|-----------------------|-----------------------|-----------------------|-----------------------------------|
| Small diameter, PVC Snap lock | 3/24 AWG<br>Yellow PVC<br>105 °C<br>4.4 mm OD | 0-125          | VAS 22-A642-*M-PSG 3  | ----                  | ----                  | ----                              |
|                               |   | 24-48          | ----                  | VAS 22-B642-*M-PSG 3  | VAS 22-D642-*M-PSG 3  | VAS 22-F642-*M-PSG 3              |
|                               |   | 110-220        | ----                  | ----                  | ----                  | ----                              |
| Small diameter, TPU Snap lock | 3/24 AWG<br>Black TPU<br>90 °C<br>4.2 mm OD   | 0-125          | VAS 22-A587-*M-PSG 3  | ----                  | ----                  | ----                              |
|                               |   | 24-48          | ----                  | VAS 22-B587-*M-PSG 3  | VAS 22-D587-*M-PSG 3  | VAS 22-F587-*M-PSG 3              |
|                               |   | 110-220        | ----                  | ----                  | ----                  | ----                              |
| Small diameter, PVC Threaded  | 3/24 AWG<br>Yellow PVC<br>105 °C<br>4.4 mm OD | 0-125          | VAS 22-A642-*M-PSG 3M | ----                  | ----                  | ----                              |
|                               |   | 24-48          | ----                  | VAS 22-B642-*M-PSG 3M | VAS 22-D642-*M-PSG 3M | VAS 22-F642-*M-PSG 3M             |
|                               |   | 110-220        | ----                  | ----                  | ----                  | ----                              |
| Small diameter, TPU Threaded  | 3/24 AWG<br>Black TPU<br>90 °C<br>4.2 mm OD   | 0-125          | VAS 22-A587-*M-PSG 3M | ----                  | ----                  | ----                              |
|                               |   | 24-48          | ----                  | VAS 22-B587-*M-PSG 3M | VAS 22-D587-*M-PSG 3M | VAS 22-F587-*M-PSG 3M             |
|                               |   | 110-220        | ----                  | ----                  | ----                  | ----                              |

\* Length in meters.

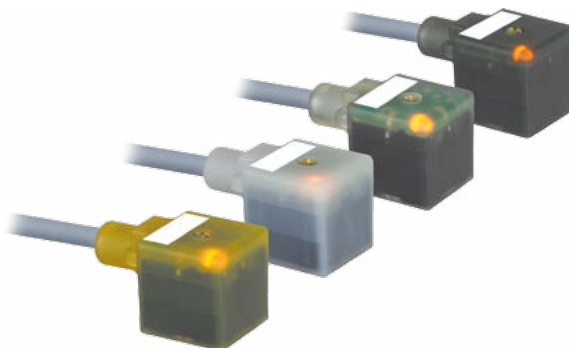

We reserve the right to make technical alterations without prior notice.

Type "A" (18 mm) Valve Connector to Eurofast® Extension

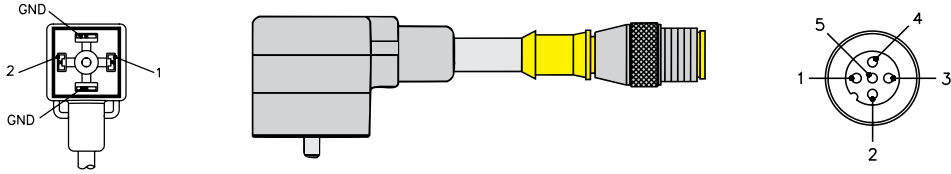

Wiring Diagrams

| Straight Wired (A) | Indicator LED (B, C) | Indicator LED and MOV (D, E) | Indicator LED and Diode - DC (F) |
|--------------------|----------------------|------------------------------|----------------------------------|
|                    |                      |                              |                                  |

We reserve the right to make technical alterations without prior notice.

Type "A" (18 mm) Valve Connector to Eurofast Extension

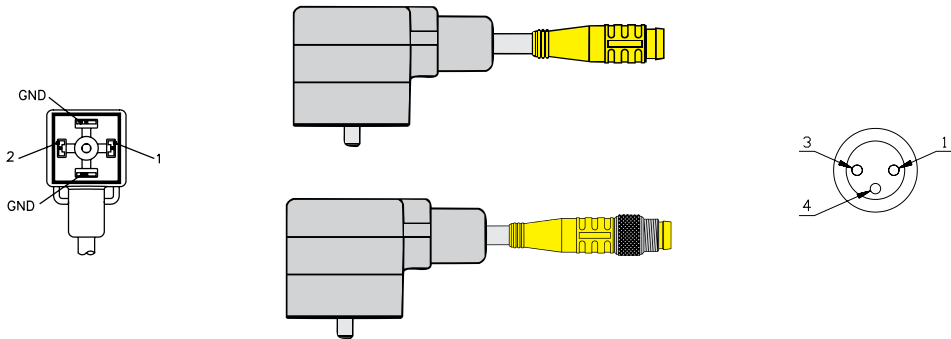

Wiring Diagrams

| Straight Wired (A) | Indicator LED (B, C) | Indicator LED and MOV (D, E) | Indicator LED and Diode - DC (F) |
|--------------------|----------------------|------------------------------|----------------------------------|
|                    |                      |                              |                                  |

Valve Plug

# Valve Plug Connectivity

## Valve Connectors, Type "A" (18 mm) Extensions

- Minifast® and Microfast® Connectors
- Available with PVC and TPU Jackets
- 18 AWG
- 2 Conductors + Ground, Ground Contacts Parallel Wired

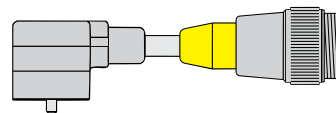

### "A" Style Valve Connectors, Minifast Extension

#### Minifast Extension

| Application       | Cable Specs   | Voltage VAC/DC | Straight Wired        | Indicator LED         | Indicator LED and MOV** |
|-------------------|---|----------------|-----------------------|-----------------------|-------------------------|
| Standard duty PVC | 3/18 AWG, Grey PVC<br>105 °C<br>6.2 mm OD<br>Black Body | 0-220          | VAS 22-A653-*M-RSM 30 | ----                  | ----                    |
|                   |   | 24-48          | ----                  | VAS 22-B653-*M-RSM 30 | VAS 22-D653-*M-RSM 30   |
|                   |   | 110-220        | ----                  | VAS 22-C653-*M-RSM 30 | VAS 22-E653-*M-RSM 30   |
| Standard duty TPU | 3/18 AWG, Grey TPU<br>90 °C<br>6.2 mm OD<br>Black Body  | 0-220          | VAS 22-A669-*M-RSM 30 | ----                  | ----                    |
|                   |   | 24-48          | ----                  | VAS 22-B669-*M-RSM 30 | VAS 22-D669-*M-RSM 30   |
|                   |   | 110-220        | ----                  | VAS 22-C669-*M-RSM 30 | VAS 22-E669-*M-RSM 30   |

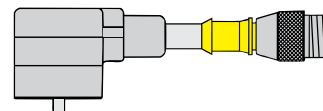

### "A" Style Valve Connectors, Microfast Extension

#### Microfast Extension

| Application       | Cable Specs   | Voltage VAC/DC | Straight Wired       | Indicator LED        | Indicator LED and MOV** |
|-------------------|---|----------------|----------------------|----------------------|-------------------------|
| Standard duty PVC | 3/18 AWG, Grey PVC<br>105 °C<br>6.2 mm OD<br>Black Body | 0-220          | VAS 22-A653-*M-SB 3T | ----                 | ----                    |
|                   |   | 24-48          | ----                 | VAS 22-B653-*M-SB 3T | VAS 22-D653-*M-SB 3T    |
|                   |   | 110-220        | ----                 | VAS 22-C653-*M-SB 3T | VAS 22-E653-*M-SB 3T    |
| Standard duty TPU | 3/18 AWG, Grey TPU<br>90 °C<br>6.0 mm OD<br>Black Body  | 0-220          | VAS 22-A669-*M-SB 3T | ----                 | ----                    |
|                   |   | 24-48          | ----                 | VAS 22-B669-*M-SB 3T | VAS 22-D669-*M-SB 3T    |
|                   |   | 110-220        | ----                 | VAS 22-C669-*M-SB 3T | VAS 22-E669-*M-SB 3T    |

\* Length in meters.

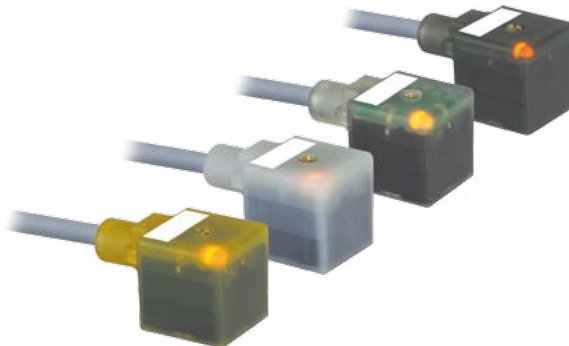

We reserve the right to make technical alterations without prior notice.

Type "A" (18 mm) Valve Connector to Minifast® Extension

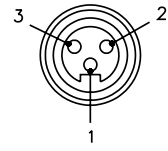
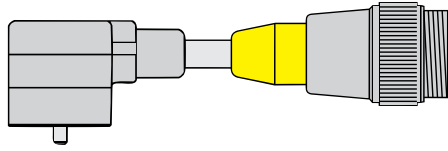
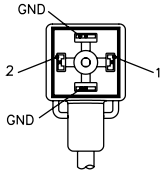

Wiring Diagrams

| Straight Wired (A) | Indicator LED (B, C) | Indicator LED and MOV (D, E) |
|--------------------|----------------------|------------------------------|
|                    |                      |                              |

We reserve the right to make technical alterations without prior notice.

Type "A" (18 mm) Valve Connector to Microfast® Extension

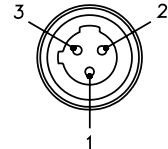
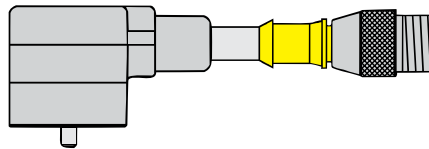
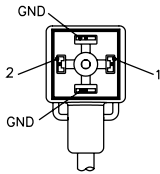

Wiring Diagrams

| Straight Wired (A) | Indicator LED (B, C) | Indicator LED and MOV (D, E) |
|--------------------|----------------------|------------------------------|
|                    |                      |                              |

Valve Plug

# Valve Plug Connectivity

## Valve Connectors Type "A" (18 mm), 3 Conductors + Ground

- Available with PVC and TPU Jackets
- 18 and 24 AWG
- 3 Conductors + Ground

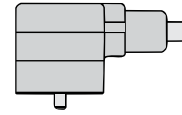

### "A" Style Valve Connectors, IEC Color Code

Type A

| Application       | Cable Specs                                | Pinout                              | Voltage VAC/DC            | Straight Wired                | Indicator LED                          | Indicator LED and MOV**                |
|-------------------|--|-------------------------------------|---------------------------|-------------------------------|--|--|
| Standard duty PVC | 4/18 AWG, Grey PVC<br>105 °C<br>6.7 mm OD  | 1. BN<br>2. BU<br>3. WH<br>Gnd - BK | 0-220<br>24-48<br>110-220 | VAS 3-A580-*M<br>----<br>---- | ----<br>VAS 3-B580-*M<br>VAS 3-C580-*M | ----<br>VAS 3-D580-*M<br>VAS 3-E580-*M |
| Standard duty TPU | 4/18 AWG, Yellow TPU<br>90 °C<br>7.2 mm OD | 1. BN<br>2. BU<br>3. WH<br>Gnd - BK | 0-220<br>24-48<br>110-220 | VAS 3-A544-*M<br>----<br>---- | ----<br>VAS 3-B544-*M<br>VAS 3-C544-*M | ----<br>VAS 3-D544-*M<br>VAS 3-E544-*M |

\* Length in meters.

We reserve the right to make technical alterations without prior notice.

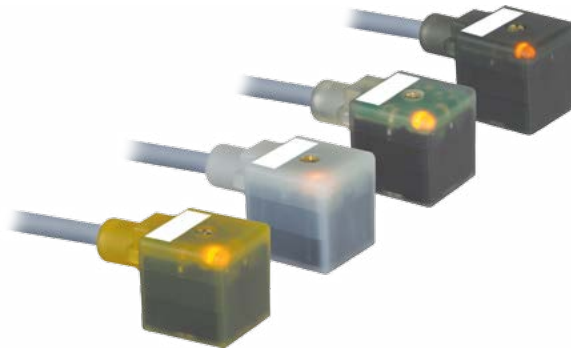

## Valve Connectors Type "A" (18 mm), 3 Conductors + Ground

### Specifications

- Connectors:** Oil resistant polyurethane body material, Nylon contact carrier.
- Contacts:** Silver plated copper alloy.
- Cable:** See table.
- Cable Length:** Standard cable lengths are nominal 2, 5 and 10 meters. Other lengths available by request - consult factory.
- Protection Class:** NEMA 1, 3, 4, 6P and IEC IP 67 when connected and secured.

**Options:** Grey connector body available (special order), change part number VAS .. or VAY .. to VAG ..  
For other combinations or options, consult factory.

### Dimensions

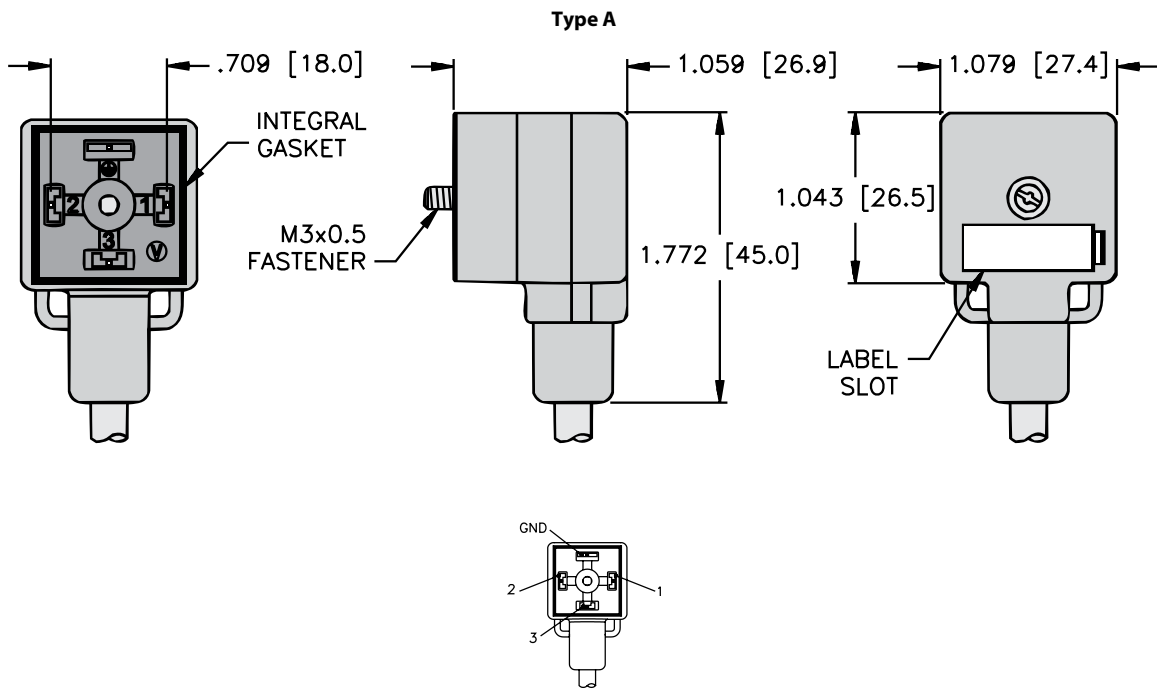

We reserve the right to make technical alterations without prior notice.

### Wiring Diagrams

| Straight Wired (A) | Indicator LED (B, C) | Indicator LED and MOV (D, E) |
|--------------------|----------------------|------------------------------|
|                    |                      |                              |

# Valve Plug Connectivity

## Valve Connectors, Type "A" (18 mm) Extensions

- Eurofast® Connectors
- Available with PVC and TPU Jackets
- 18 AWG
- 3 Conductors + Ground

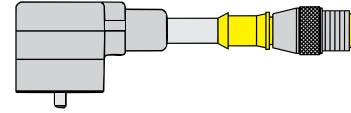

### "A" Style Valve Connectors, Eurofast Extension

#### Eurofast Extension

| Application       | Cable Specs             | Voltage VAC/DC | Straight Wired          | Indicator LED           | Indicator LED and MOV** |
|-------------------|-------------------------|----------------|-------------------------|-------------------------|-------------------------|
| Standard duty PVC | 4/18 AWG, Grey PVC      | 0-220          | VAS 3-A580-*M-RSC 5.42T | ----                    | ----                    |
|                   | 105 °C                  | 24-48          | ----                    | VAS 3-B580-*M-RSC 5.42T | VAS 3-D580-*M-RSC 5.42T |
|                   | 6.7 mm OD<br>Black Body | 110-220        | ----                    | VAS 3-C580-*M-RSC 5.42T | VAS 3-E580-*M-RSC 5.42T |
| Standard duty TPU | 4/18 AWG, Yellow TPU    | 0-220          | VAS 3-A544-*M-RSC 5.42T | ----                    | ----                    |
|                   | 90 °C                   | 24-48          | ----                    | VAS 3-B544-*M-RSC 5.42T | VAS 3-D544-*M-RSC 5.42T |
|                   | 7.2 mm OD<br>Black Body | 110-220        | ----                    | VAS 3-C544-*M-RSC 5.42T | VAS 3-E544-*M-RSC 5.42T |

\* Length in meters.

We reserve the right to make technical alterations without prior notice.

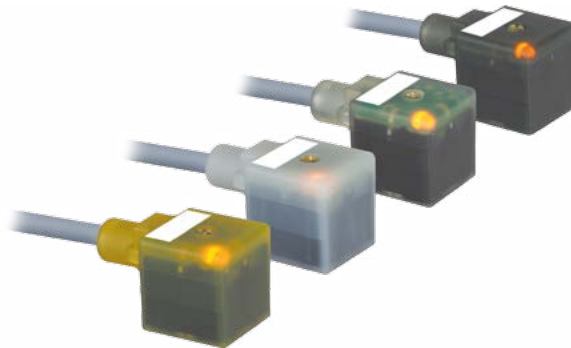



### Type "A" (18 mm) Valve Connector to Eurofast® Extension

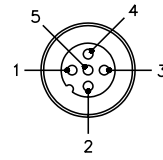
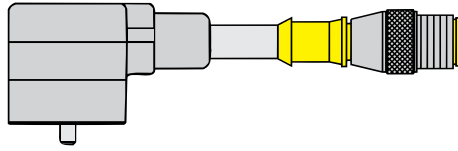
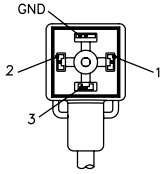

### Wiring Diagrams

| Straight Wired (A)  | Indicator LED (B, C)  | Indicator LED and MOV (D, E)  |
|---|---|---|
| <p>1 ————— 2</p> <p>2 ————— 3</p> <p>3 ————— 4</p> <p>GND ————— 5</p> | <p>Diagram showing the wiring for an indicator LED (YE) connected to terminals 1, 2, 3, 4, and 5 (GND).</p> | <p>Diagram showing the wiring for an indicator LED (YE) and MOV connected to terminals 1, 2, 3, 4, and 5 (GND).</p> |

We reserve the right to make technical alterations without prior notice.

# Valve Plug Connectivity

## Valve Connectors, Type "B" (10 mm)

- Available with PVC and TPU Jackets
- 18 and 24 AWG
- 2 Conductors + Ground

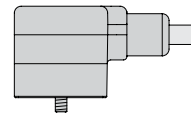

### "B" Style Valve Connectors, Standard Color Code

Type B

| Application       | Cable Specs   | Pinout                            | Voltage VAC/DC | Straight Wired | Indicator LED | Indicator LED and MOV** | Indicator LED and Diode - DC only |
|-------------------|---|-----------------------------------|----------------|----------------|---------------|-------------------------|-----------------------------------|
| Standard duty PVC | 3/18 AWG, Grey PVC<br>105 °C<br>6.2 mm OD<br>Black Body | 1. BK 1<br>2. BK 2<br>Gnd - GN/YE | 0-220          | VBS 2-A653-*M  | ----          | ----                    | ----                              |
|                   |   |                                   | 24-48          | ----           | VBS 2-B653-*M | VBS 2-D653-*M           | VBS 2-F653-*M                     |
|                   |   |                                   | 110-220        | ----           | VBS 2-C653-*M | VBS 2-E653-*M           | ----                              |
| Standard duty TPU | 3/18 AWG, Grey TPU<br>90 °C<br>6.0 mm OD<br>Black Body  | 1. BK 1<br>2. BK 2<br>Gnd - GN/YE | 0-220          | VBS 2-A669-*M  | ----          | ----                    | ----                              |
|                   |   |                                   | 24-48          | ----           | VBS 2-B669-*M | VBS 2-D669-*M           | VBS 2-F669-*M                     |
|                   |   |                                   | 110-220        | ----           | VBS 2-C669-*M | VBS 2-E669-*M           | ----                              |

### "B" Style Valve Connectors, IEC Color Code

| Application        | Cable Specs   | Pinout                     | Voltage VAC/DC | Straight Wired | Indicator LED | Indicator LED and MOV** | Indicator LED and Diode - DC only |
|--------------------|---|----------------------------|----------------|----------------|---------------|-------------------------|-----------------------------------|
| Small diameter PVC | 3/24 AWG, Yellow PVC<br>105 °C<br>4.4 mm OD<br>Black Body | 1. BN<br>2. BU<br>Gnd - BK | 0-220          | VBS 2-A642-*M  | ----          | ----                    | ----                              |
|                    |   |                            | 24-48          | ----           | VBS 2-B642-*M | VBS 2-D642-*M           | VBS 2-F642-*M                     |
|                    |   |                            | 110-220        | ----           | VBS 2-C642-*M | VBS 2-E642-*M           | ----                              |
| Small diameter TPU | 3/24 AWG, Black TPU<br>90 °C<br>4.2 mm OD<br>Black Body   | 1. BN<br>2. BU<br>Gnd - BK | 0-220          | VBS 2-A587-*M  | ----          | ----                    | ----                              |
|                    |   |                            | 24-48          | ----           | VBS 2-B587-*M | VBS 2-D587-*M           | VBS 2-F587-*M                     |
|                    |   |                            | 110-220        | ----           | VBS 2-C587-*M | VBS 2-E587-*M           | ----                              |

\* Length in meters.

We reserve the right to make technical alterations without prior notice.

### Specifications

- Connectors:** Oil resistant polyurethane body material, Nylon contact carrier.
- Contacts:** Silver plated copper alloy.
- Cable:** See table.
- Cable Length:** Standard cable lengths are nominal 2, 5 and 10 meters. Other lengths available by request - consult factory.
- Protection Class:** NEMA 1, 3, 4, 6P and IEC IP 67 when connected and secured.

**Options:** Grey connector body available (special order), change part number VBS .. or VBY .. to VBG ..  
 To have cable exit on the same side as the ground pin, change part number from VBS .. to TBS ..  
 For other combinations or options, consult factory.

### Dimensions

Type B

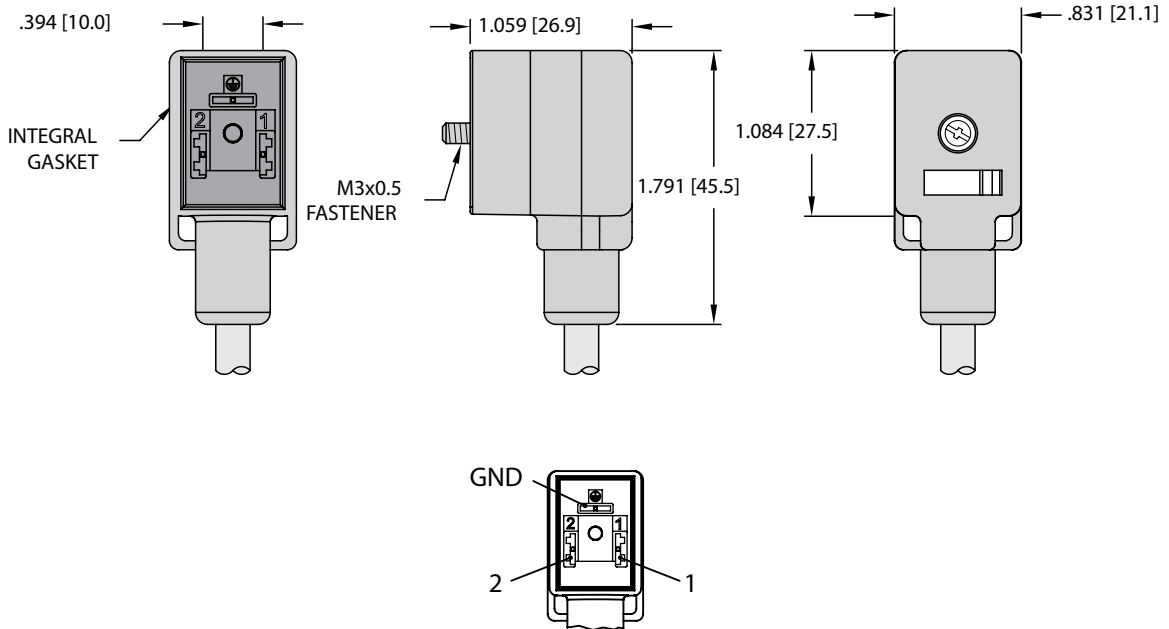

We reserve the right to make technical alterations without prior notice.

Valve Plug

### Wiring Diagrams

| Straight Wired (A) | Indicator LED (B, C) | Indicator LED and MOV (D, E) | Indicator LED and Diode - DC (F) |
|--------------------|----------------------|------------------------------|----------------------------------|
|                    |                      |                              |                                  |

# Valve Plug Connectivity

## Valve Connectors, Type "B" (10 mm) Extensions

- Available with PVC, TPU and Jackets
- 18 and 24 AWG
- 2 Conductors + Ground, Ground Contacts Parallel Wired

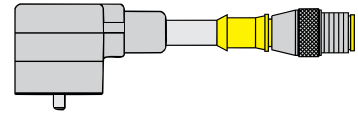

### "B" Style Valve Connectors, Eurofast® Extension

Eurofast Extension

| Application       | Cable Specs                                 | Voltage VAC/DC | Straight Wired        | Indicator LED         | Indicator LED and MOV | Indicator LED and Diode - DC only |
|-------------------|---|----------------|-----------------------|-----------------------|-----------------------|-----------------------------------|
| Standard duty PVC | 3/18 AWG<br>Grey PVC<br>105 °C<br>6.2 mm OD | 0-220          | VBS 2-A653-*M-RS 5.3T | ----                  | ----                  | ----                              |
|                   |   | 24-48          | ----                  | VBS 2-B653-*M-RS 5.3T | VBS 2-D653-*M-RS 5.3T | VBS 2-F653-*M-RS 5.3T             |
|                   |   | 110-220        | ----                  | VBS 2-C653-*M-RS 5.3T | VBS 2-E653-*M-RS 5.3T | ----                              |
| Standard duty TPU | 3/18 AWG<br>Grey TPU<br>90 °C<br>6.0 mm OD  | 0-220          | VBS 2-A669-*M-RS 5.3T | ----                  | ----                  | ----                              |
|                   |   | 24-48          | ----                  | VBS 2-B669-*M-RS 5.3T | VBS 2-D669-*M-RS 5.3T | VBS 2-F669-*M-RS 5.3T             |
|                   |   | 110-220        | ----                  | VBS 2-C669-*M-RS 5.3T | VBS 2-E669-*M-RS 5.3T | ----                              |

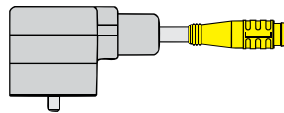

Picofast Snap Extension

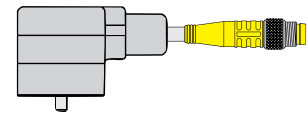

Picofast Threaded Extension

### "B" Style Valve Connectors, Picofast® Extension

| Application                   | Cable Specs                                   | Voltage VAC/DC | Straight Wired       | Indicator LED        | Indicator LED and MOV | Indicator LED and Diode - DC only |
|-------------------------------|---|----------------|----------------------|----------------------|-----------------------|-----------------------------------|
| Small diameter, PVC Snap lock | 3/24 AWG<br>Yellow PVC<br>105 °C<br>4.4 mm OD | 0-125          | VBS 2-A642-*M-PSG 3  | ----                 | ----                  | ----                              |
|                               |   | 24-48          | ----                 | VBS 2-B642-*M-PSG 3  | VBS 2-D642-*M-PSG 3   | VBS 2-F642-*M-PSG 3               |
|                               |   | 110-220        | ----                 | ----                 | ----                  | ----                              |
| Small diameter, TPU Snap lock | 3/24 AWG<br>Black TPU<br>90 °C<br>4.2 mm OD   | 0-125          | VBS 2-A587-*M-PSG 3  | ----                 | ----                  | ----                              |
|                               |   | 24-48          | ----                 | VBS 2-B587-*M-PSG 3  | VBS 2-D587-*M-PSG 3   | VBS 2-F587-*M-PSG 3               |
|                               |   | 110-220        | ----                 | ----                 | ----                  | ----                              |
| Small diameter, PVC Threaded  | 3/24 AWG<br>Yellow PVC<br>105 °C<br>4.4 mm OD | 0-125          | VBS 2-A642-*M-PSG 3M | ----                 | ----                  | ----                              |
|                               |   | 24-48          | ----                 | VBS 2-B642-*M-PSG 3M | VBS 2-D642-*M-PSG 3M  | VBS 2-F642-*M-PSG 3M              |
|                               |   | 110-220        | ----                 | ----                 | ----                  | ----                              |
| Small diameter, TPU Threaded  | 3/24 AWG<br>Black TPU<br>90 °C<br>4.2 mm OD   | 0-125          | VBS 2-A587-*M-PSG 3M | ----                 | ----                  | ----                              |
|                               |   | 24-48          | ----                 | VBS 2-B587-*M-PSG 3M | VBS 2-D587-*M-PSG 3M  | VBS 2-F587-*M-PSG 3M              |
|                               |   | 110-220        | ----                 | ----                 | ----                  | ----                              |

\* Length in meters.

We reserve the right to make technical alterations without prior notice.

Type "B" (10 mm) Valve Connector to Eurofast® Extension

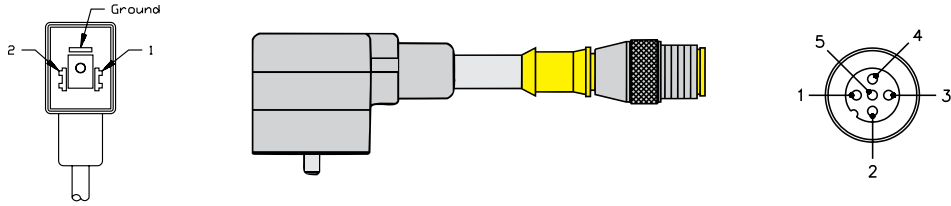

Wiring Diagrams

| Straight Wired (A)                       | Indicator LED (B, C) | Indicator LED and MOV (D, E) | Indicator LED and Diode - DC (F) |
|--|----------------------|------------------------------|----------------------------------|
| <p>1 → 4</p> <p>2 → 3</p> <p>GND → 5</p> |                      |                              | <p>DC ONLY</p>                   |

Type "B" (10 mm) Valve Connector to Picofast® Extension

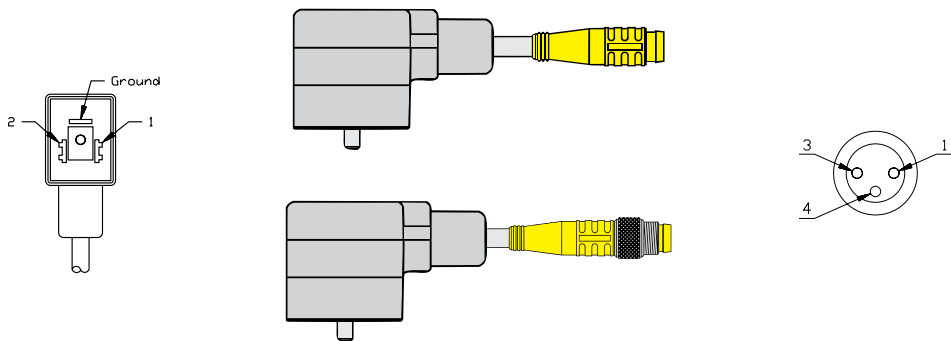

Wiring Diagrams

| Straight Wired (A)                        | Indicator LED (B, C) | Indicator LED and MOV (D, E) | Indicator LED and Diode - DC (F) |
|---|----------------------|------------------------------|----------------------------------|
| <p>1 → 4</p> <p>2 → 3</p> <p>GND → NC</p> |                      |                              | <p>DC ONLY</p>                   |

# Valve Plug Connectivity

## Valve Connectors, Type "B" (10 mm) Extensions

- Minifast® and Microfast® Connectors
- 18 AWG
- 2 Conductors + Ground

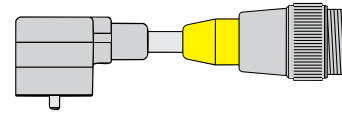

### "B" Style Valve Connectors, Minifast Extension

#### Minifast Extension

| Application       | Cable Specs   | Voltage VAC/DC | Straight Wired       | Indicator LED        | Indicator LED and MOV** |
|-------------------|---|----------------|----------------------|----------------------|-------------------------|
| Standard duty PVC | 3/18 AWG, Grey PVC<br>105 °C<br>6.2 mm OD<br>Black Body | 0-220          | VBS 2-A653-*M-RSM 30 | ----                 | ----                    |
|                   |   | 24-48          | ----                 | VBS 2-B653-*M-RSM 30 | VBS 2-D653-*M-RSM 30    |
|                   |   | 110-220        | ----                 | VBS 2-C653-*M-RSM 30 | VBS 2-E653-*M-RSM 30    |
| Standard duty TPU | 3/18 AWG, Grey TPU<br>90 °C<br>6.0 mm OD<br>Black Body  | 0-220          | VBS 2-A669-*M-RSM 30 | ----                 | ----                    |
|                   |   | 24-48          | ----                 | VBS 2-B669-*M-RSM 30 | VBS 2-D669-*M-RSM 30    |
|                   |   | 110-220        | ----                 | VBS 2-C669-*M-RSM 30 | VBS 2-E669-*M-RSM 30    |

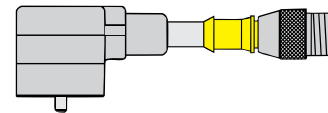

### "B" Style Valve Connectors, Microfast Extension

#### Microfast Extension

| Application       | Cable Specs   | Voltage VAC/DC | Straight Wired      | Indicator LED       | Indicator LED and MOV** |
|-------------------|---|----------------|---------------------|---------------------|-------------------------|
| Standard duty PVC | 3/18 AWG, Grey PVC<br>105 °C<br>6.2 mm OD<br>Black Body | 0-220          | VBS 2-A653-*M-SB 3T | ----                | ----                    |
|                   |   | 24-48          | ----                | VBS 2-B653-*M-SB 3T | VBS 2-D653-*M-SB 3T     |
|                   |   | 110-220        | ----                | VBS 2-C653-*M-SB 3T | VBS 2-E653-*M-SB 3T     |
| Standard duty TPU | 3/18 AWG, Grey TPU<br>90 °C<br>6.0 mm OD<br>Black Body  | 0-220          | VBS 2-A669-*M-SB 3T | ----                | ----                    |
|                   |   | 24-48          | ----                | VBS 2-B669-*M-SB 3T | VBS 2-D669-*M-SB 3T     |
|                   |   | 110-220        | ----                | VBS 2-C669-*M-SB 3T | VBS 2-E669-*M-SB 3T     |

\* Length in meters.

We reserve the right to make technical alterations without prior notice.

Type "B" (10 mm) Valve Connector to Minifast® Extension

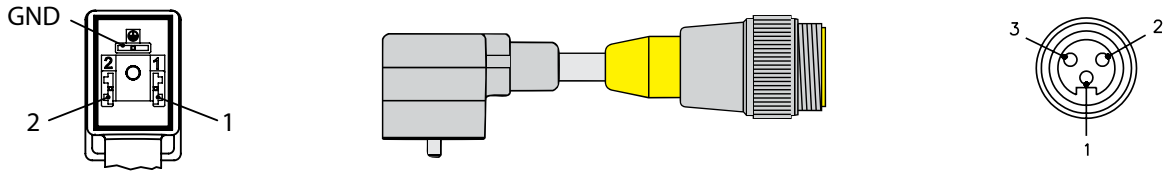

Wiring Diagrams

| Straight Wired (A)   | Indicator LED (B, C) | Indicator LED and MOV (D, E) |
|--|----------------------|------------------------------|
| <p>1 ) —————&gt; 2</p> <p>2 ) —————&gt; 3</p> <p>GND ) —————&gt; 1</p> |                      |                              |

Type "B" (10 mm) Valve Connector to Microfast® Extension

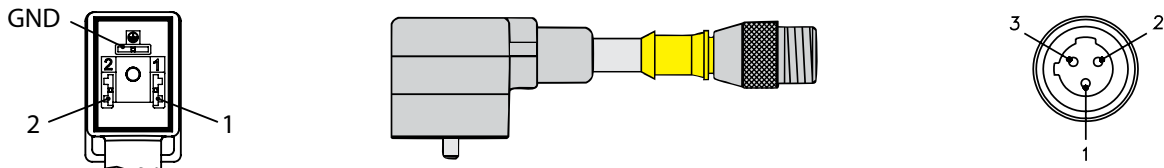

Wiring Diagrams

| Straight Wired (A)   | Indicator LED (B, C) | Indicator LED and MOV (D, E) |
|--|----------------------|------------------------------|
| <p>1 ) —————&gt; 2</p> <p>2 ) —————&gt; 3</p> <p>GND ) —————&gt; 1</p> |                      |                              |

# Valve Plug Connectivity

## Valve Connectors, Type "I" (11 mm)

- Available with PVC and TPU Jackets
- 18 and 24 AWG
- 2 Conductors + Ground

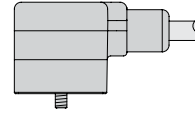

### "I" Style Valve Connectors, Standard Color Code

Type I

| Application       | Cable Specs   | Pinout                            | Voltage VAC/DC | Straight Wired | Indicator LED | Indicator LED and MOV** | Indicator LED and Diode - DC only |
|-------------------|---|-----------------------------------|----------------|----------------|---------------|-------------------------|-----------------------------------|
| Standard duty PVC | 3/18 AWG, Grey PVC<br>105 °C<br>6.2 mm OD<br>Black Body | 1. BK 1<br>2. BK 2<br>Gnd - GN/YE | 0-220          | VIS 2-A653-*M  | ----          | ----                    | ----                              |
|                   |   |                                   | 24-48          | ----           | VIS 2-B653-*M | VIS 2-D653-*M           | VIS 2-F653-*M                     |
|                   |   |                                   | 110-220        | ----           | VIS 2-C653-*M | VIS 2-E653-*M           | ----                              |
| Standard duty TPU | 3/18 AWG, Grey TPU<br>90 °C<br>6.0 mm OD<br>Black Body  | 1. BK 1<br>2. BK 2<br>Gnd - GN/YE | 0-220          | VIS 2-A669-*M  | ----          | ----                    | ----                              |
|                   |   |                                   | 24-48          | ----           | VIS 2-B669-*M | VIS 2-D669-*M           | VIS 2-F669-*M                     |
|                   |   |                                   | 110-220        | ----           | VIS 2-C669-*M | VIS 2-E669-*M           | ----                              |

### "I" Style Valve Connectors, IEC Color Code

| Application        | Cable Specs   | Pinout                     | Voltage VAC/DC | Straight Wired | Indicator LED | Indicator LED and MOV** | Indicator LED and Diode - DC only |
|--------------------|---|----------------------------|----------------|----------------|---------------|-------------------------|-----------------------------------|
| Small diameter PVC | 3/24 AWG, Yellow PVC<br>105 °C<br>4.4 mm OD<br>Black Body | 1. BN<br>2. BU<br>Gnd - BK | 0-220          | VIS 2-A642-*M  | ----          | ----                    | ----                              |
|                    |   |                            | 24-48          | ----           | VIS 2-B642-*M | VIS 2-D642-*M           | VIS 2-F642-*M                     |
|                    |   |                            | 110-220        | ----           | VIS 2-C642-*M | VIS 2-E642-*M           | ----                              |
| Small diameter TPU | 3/24 AWG, Black TPU<br>90 °C<br>4.2 mm OD<br>Black Body   | 1. BN<br>2. BU<br>Gnd - BK | 0-220          | VIS 2-A587-*M  | ----          | ----                    | ----                              |
|                    |   |                            | 24-48          | ----           | VIS 2-B587-*M | VIS 2-D587-*M           | VIS 2-F587-*M                     |
|                    |   |                            | 110-220        | ----           | VIS 2-C587-*M | VIS 2-E587-*M           | ----                              |

\* Length in meters.

We reserve the right to make technical alterations without prior notice.



### Specifications

- Connectors:** Oil resistant polyurethane body material, Nylon contact carrier.
- Contacts:** Silver plated copper alloy.
- Cable:** See table.
- Cable Length:** Standard cable lengths are nominal 2, 5 and 10 meters. Other lengths available by request - consult factory.
- Protection Class:** NEMA 1, 3, 4, 6P and IEC IP 67 when connected and secured.

**Options:** Grey connector body available (special order), change part number VIS .. or VIY .. to VIG ..  
 To have cable exit on the same side as the ground pin, change part number from VIS .. to TIS ..  
 For other combinations or options, consult factory.

### Dimensions

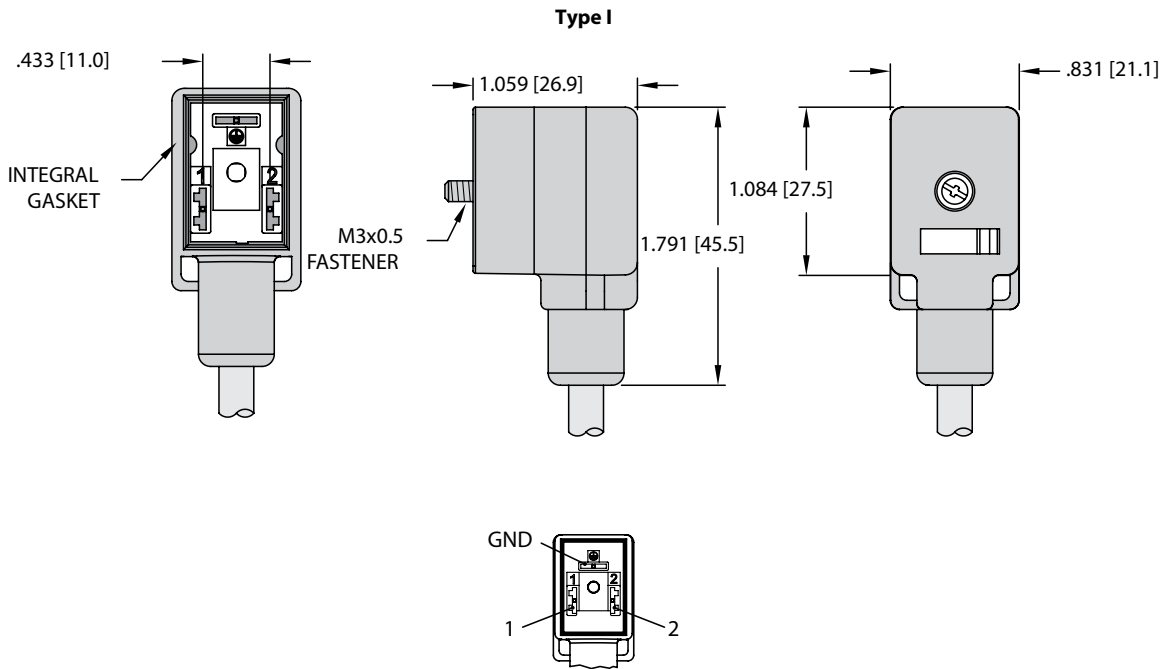

We reserve the right to make technical alterations without prior notice.

Valve Plug

### Wiring Diagrams

| Straight Wired (A)  | Indicator LED (B, C)  | Indicator LED and MOV (D, E)   | Indicator LED and Diode - DC (F)  |
|---|---|--|---|
| <p>Diagram A shows a straight-wired configuration with three terminals: 1, 2, and GND. Terminal 1 is connected to terminal 2, and terminal 2 is connected to GND.</p> | <p>Diagram B shows an LED circuit. Terminal 1 is connected to one terminal of a diode bridge. Terminal 2 is connected to the other terminal of the diode bridge. GND is connected to the common terminal of the diode bridge. An LED (YE) is connected in series with a resistor between the bridge output and GND.</p> | <p>Diagram D shows an LED and MOV circuit. Terminal 1 is connected to one terminal of a diode bridge. Terminal 2 is connected to the other terminal of the diode bridge. GND is connected to the common terminal of the diode bridge. An LED (YE) and a MOV are connected in series between the bridge output and GND.</p> | <p>Diagram F shows an LED and diode circuit for DC. Terminal 1 is connected to one terminal of a diode bridge. Terminal 2 is connected to the other terminal of the diode bridge. GND is connected to the common terminal of the diode bridge. An LED (YE) and a diode are connected in series between the bridge output and GND.</p> |

# Valve Plug Connectivity

## Valve Connectors, Type "I" (11 mm) Extensions

- Eurofast® and Picofast® Connectors
- Wired for use with Junction Box
- 2 Conductors + Ground

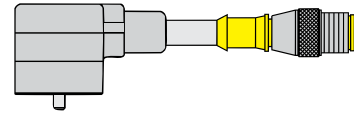

### "I" Style Valve Connectors, Eurofast Extension

Eurofast Extension

| Application       | Cable Specs                                 | Voltage VAC/DC | Straight Wired        | Indicator LED         | Indicator LED and MOV | Indicator LED and Diode - DC only |
|-------------------|---|----------------|-----------------------|-----------------------|-----------------------|-----------------------------------|
| Standard duty PVC | 3/18 AWG<br>Grey PVC<br>105 °C<br>6.2 mm OD | 0-220          | VIS 2-A653-*M-RS 5.3T | ----                  | ----                  | ----                              |
|                   |   | 24-48          | ----                  | VIS 2-B653-*M-RS 5.3T | VIS 2-D653-*M-RS 5.3T | VIS 2-F653-*M-RS 5.3T             |
|                   |   | 110-220        | ----                  | VIS 2-C653-*M-RS 5.3T | VIS 2-E653-*M-RS 5.3T | ----                              |
| Standard duty TPU | 3/18 AWG<br>Grey TPU<br>90 °C<br>6.0 mm OD  | 0-220          | VIS 2-A669-*M-RS 5.3T | ----                  | ----                  | ----                              |
|                   |   | 24-48          | ----                  | VIS 2-B669-*M-RS 5.3T | VIS 2-D669-*M-RS 5.3T | VIS 2-F669-*M-RS 5.3T             |
|                   |   | 110-220        | ----                  | VIS 2-C669-*M-RS 5.3T | VIS 2-E669-*M-RS 5.3T | ----                              |

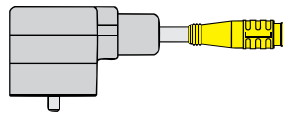

Picofast Snap Extension

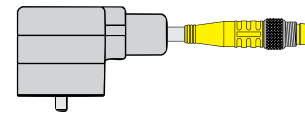

Picofast Threaded Extension

### "I" Style Valve Connectors, Picofast Extension

| Application                   | Cable Specs                                   | Voltage VAC/DC | Straight Wired       | Indicator LED        | Indicator LED and MOV | Indicator LED and Diode - DC only |
|-------------------------------|---|----------------|----------------------|----------------------|-----------------------|-----------------------------------|
| Small diameter, PVC Snap lock | 3/24 AWG<br>Yellow PVC<br>105 °C<br>4.4 mm OD | 0-125          | VIS 2-A642-*M-PSG 3  | ----                 | ----                  | ----                              |
|                               |   | 24-48          | ----                 | VIS 2-B642-*M-PSG 3  | VIS 2-D642-*M-PSG 3   | VIS 2-F642-*M-PSG 3               |
|                               |   | 110-220        | ----                 | ----                 | ----                  | ----                              |
| Small diameter, TPU Snap lock | 3/24 AWG<br>Black TPU<br>90 °C<br>4.2 mm OD   | 0-125          | VIS 2-A587-*M-PSG 3  | ----                 | ----                  | ----                              |
|                               |   | 24-48          | ----                 | VIS 2-B587-*M-PSG 3  | VIS 2-D587-*M-PSG 3   | VIS 2-F587-*M-PSG 3               |
|                               |   | 110-220        | ----                 | ----                 | ----                  | ----                              |
| Small diameter, PVC Threaded  | 3/24 AWG<br>Yellow PVC<br>105 °C<br>4.4 mm OD | 0-125          | VIS 2-A642-*M-PSG 3M | ----                 | ----                  | ----                              |
|                               |   | 24-48          | ----                 | VIS 2-B642-*M-PSG 3M | VIS 2-D642-*M-PSG 3M  | VIS 2-F642-*M-PSG 3M              |
|                               |   | 110-220        | ----                 | ----                 | ----                  | ----                              |
| Small diameter, TPU Threaded  | 3/24 AWG<br>Black TPU<br>90 °C<br>4.2 mm OD   | 0-125          | VIS 2-A587-*M-PSG 3M | ----                 | ----                  | ----                              |
|                               |   | 24-48          | ----                 | VIS 2-B587-*M-PSG 3M | VIS 2-D587-*M-PSG 3M  | VIS 2-F587-*M-PSG 3M              |
|                               |   | 110-220        | ----                 | ----                 | ----                  | ----                              |

\* Length in meters.

We reserve the right to make technical alterations without prior notice.

Type "I" (11 mm) Valve Connector to Eurofast® Extension

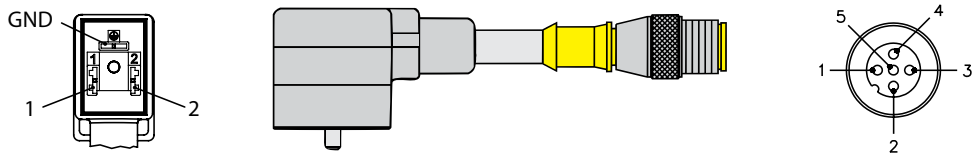

Wiring Diagrams

| Straight Wired (A)                       | Indicator LED (B, C) | Indicator LED and MOV (D, E) | Indicator LED and Diode - DC (F) |
|--|----------------------|------------------------------|----------------------------------|
| <p>1 → 4</p> <p>2 → 3</p> <p>GND → 5</p> |                      |                              | <p>DC ONLY</p>                   |

Type "I" (11 mm) Valve Connector to Picofast® Extension

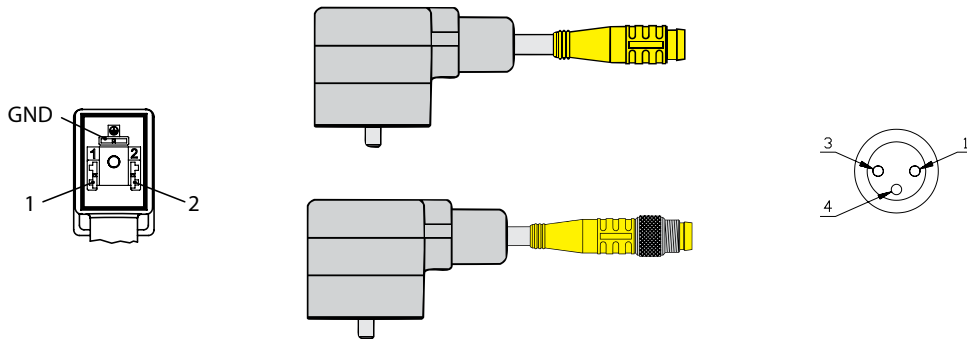

Wiring Diagrams

| Straight Wired (A)                        | Indicator LED (B, C) | Indicator LED and MOV (D, E) | Indicator LED and Diode - DC (F) |
|---|----------------------|------------------------------|----------------------------------|
| <p>1 → 4</p> <p>2 → 3</p> <p>GND → NC</p> |                      |                              | <p>DC ONLY</p>                   |

# Valve Plug Connectivity

## Valve Connectors, Type "I" (11 mm) Extensions

- Minifast® and Microfast® Connectors
- Available with PVC and TPU
- 18 AWG
- 2 Conductors + Ground (Eurofast)

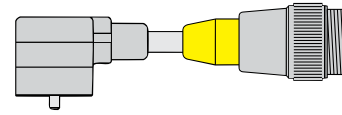

### "I" Style Valve Connectors, Minifast Extension

#### Minifast Extension

| Application       | Cable Specs             | Voltage VAC/DC | Straight Wired       | Indicator LED        | Indicator LED and MOV** |
|-------------------|-------------------------|----------------|----------------------|----------------------|-------------------------|
| Standard duty PVC | 3/18 AWG, Grey PVC      | 0-220          | VIS 2-A653-*M-RSM 30 | ----                 | ----                    |
|                   | 105 °C                  | 24-48          | ----                 | VIS 2-B653-*M-RSM 30 | VIS 2-D653-*M-RSM 30    |
|                   | 6.2 mm OD<br>Black Body | 110-220        | ----                 | VIS 2-C653-*M-RSM 30 | VIS 2-E653-*M-RSM 30    |
| Standard duty TPU | 3/18 AWG, Grey TPU      | 0-220          | VIS 2-A669-*M-RSM 30 | ----                 | ----                    |
|                   | 90 °C                   | 24-48          | ----                 | VIS 2-B669-*M-RSM 30 | VIS 2-D669-*M-RSM 30    |
|                   | 6.0 mm OD<br>Black Body | 110-220        | ----                 | VIS 2-C669-*M-RSM 30 | VIS 2-E669-*M-RSM 30    |

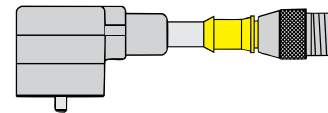

### "I" Style Valve Connectors, Microfast Extension

#### Microfast Extension

| Application       | Cable Specs             | Voltage VAC/DC | Straight Wired      | Indicator LED       | Indicator LED and MOV** |
|-------------------|-------------------------|----------------|---------------------|---------------------|-------------------------|
| Standard duty PVC | 3/18 AWG, Grey PVC      | 0-220          | VIS 2-A653-*M-SB 3T | ----                | ----                    |
|                   | 105 °C                  | 24-48          | ----                | VIS 2-B653-*M-SB 3T | VIS 2-D653-*M-SB 3T     |
|                   | 6.2 mm OD<br>Black Body | 110-220        | ----                | VIS 2-C653-*M-SB 3T | VIS 2-E653-*M-SB 3T     |
| Standard duty TPU | 3/18 AWG, Grey TPU      | 0-220          | VIS 2-A669-*M-SB 3T | ----                | ----                    |
|                   | 90 °C                   | 24-48          | ----                | VIS 2-B669-*M-SB 3T | VIS 2-D669-*M-SB 3T     |
|                   | 6.0 mm OD<br>Black Body | 110-220        | ----                | VIS 2-C669-*M-SB 3T | VIS 2-E669-*M-SB 3T     |

\* Length in meters.

We reserve the right to make technical alterations without prior notice.

Type "I" (11 mm) Valve Connector to Minifast® Extension

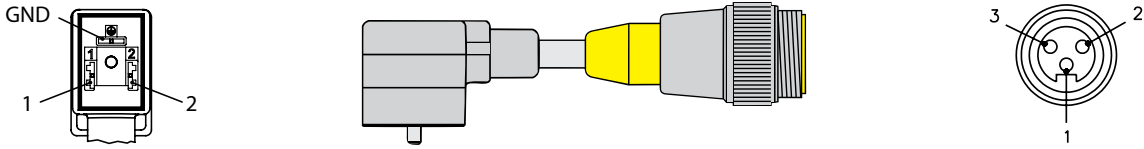

Wiring Diagrams

| Straight Wired (A)   | Indicator LED (B, C) | Indicator LED and MOV (D, E) |
|--|----------------------|------------------------------|
| <p>1 ) —————&gt; 2</p> <p>2 ) —————&gt; 3</p> <p>GND ) —————&gt; 1</p> |                      |                              |

Type "I" (11 mm) Valve Connector to Microfast® Extension

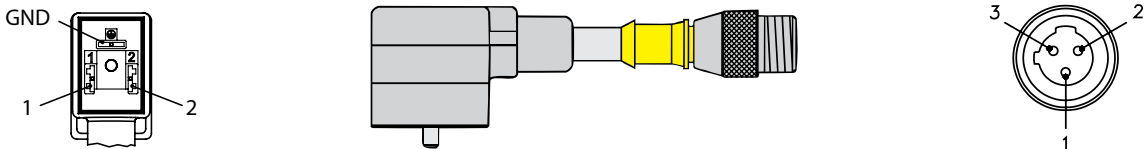

Wiring Diagrams

| Straight Wired (A)   | Indicator LED (B, C) | Indicator LED and MOV (D, E) |
|--|----------------------|------------------------------|
| <p>1 ) —————&gt; 2</p> <p>2 ) —————&gt; 3</p> <p>GND ) —————&gt; 1</p> |                      |                              |

# Valve Plug Connectivity

## Valve Connectors, Type "C" (8 mm)

- Available with PVC and TPU Jackets
- 18 and 24 AWG
- 2 Conductor + Ground

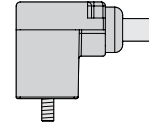

### "C" (8.0 mm) Style Valve Connectors, Standard Color Code

Type C

| Application          | Cable Specs   | Pinout                            | Voltage VAC/DC | Straight Wired | Indicator LED  | Indicator LED and Suppressor Diodes |
|----------------------|---|-----------------------------------|----------------|----------------|----------------|-------------------------------------|
| Standard duty<br>PVC | 3/18 AWG, Grey PVC<br>105 °C<br>6.2 mm OD<br>Black Body | 1. BK 1<br>2. BK 2<br>Gnd - GN/YE | 0-220          | TC8S 2-A653-*M | ----           | ----                                |
|                      |   |                                   | 24             | ----           | TC8S 2-L653-*M | TC8S 2-P653-*                       |
|                      |   |                                   | 48             | ----           | TC8S 2-M653-*M | ----                                |
|                      |   |                                   | 110            | ----           | TC8S 2-N653-*M | ----                                |
| Standard duty<br>TPU | 3/18 AWG, Grey TPU<br>90 °C<br>6.0 mm OD<br>Black Body  | 1. BK 1<br>2. BK 2<br>Gnd - GN/YE | 0-220          | TC8S 2-A669-*M | ----           | ----                                |
|                      |   |                                   | 24             | ----           | TC8S 2-L669-*M | TC8S 2-P669-*                       |
|                      |   |                                   | 48             | ----           | TC8S 2-M669-*M | ----                                |
|                      |   |                                   | 110            | ----           | TC8S 2-N669-*M | ----                                |

### "C" (8.0 mm) Style Valve Connectors, IEC Color Code

| Application           | Cable Specs   | Pinout                     | Voltage VAC/DC | Straight Wired | Indicator LED  | Indicator LED and Suppressor Diodes |
|-----------------------|---|----------------------------|----------------|----------------|----------------|-------------------------------------|
| Small diameter<br>PVC | 3/24 AWG, Yellow PVC<br>105 °C<br>4.4 mm OD<br>Black Body | 1. BN<br>2. BU<br>Gnd - BK | 0-220          | TC8S 2-A642-*M | ----           | ----                                |
|                       |   |                            | 24             | ----           | TC8S 2-L642-*M | TC8S 2-P642-*                       |
|                       |   |                            | 48             | ----           | TC8S 2-M642-*M | ----                                |
|                       |   |                            | 110            | ----           | TC8S 2-N642-*M | ----                                |
| Small diameter<br>TPU | 3/24 AWG, Black TPU<br>90 °C<br>4.2 mm OD<br>Black Body   | 1. BN<br>2. BU<br>Gnd - BK | 0-220          | TC8S 2-A587-*M | ----           | ----                                |
|                       |   |                            | 24             | ----           | TC8S 2-L587-*M | TC8S 2-P587-*                       |
|                       |   |                            | 48             | ----           | TC8S 2-M587-*M | ----                                |
|                       |   |                            | 110            | ----           | TC8S 2-N587-*M | ----                                |

\* Length in meters.

We reserve the right to make technical alterations without prior notice.

### Specifications

- Connectors:** Oil resistant polyurethane body material, Nylon contact carrier.
- Contacts:** Silver plated copper alloy.
- Cable:** See table.
- Cable Length:** Standard cable lengths are nominal 5 meters. Other lengths available by request - consult factory.
- Protection Class:** NEMA 1, 3, 4, 6P and IEC IP 67 when connected and secured.

**Options:** Grey connector body available (special order), change part number TC8S... To TC8G...  
For other combinations or options, consult factory.

### Dimensions

Type C (8 mm)

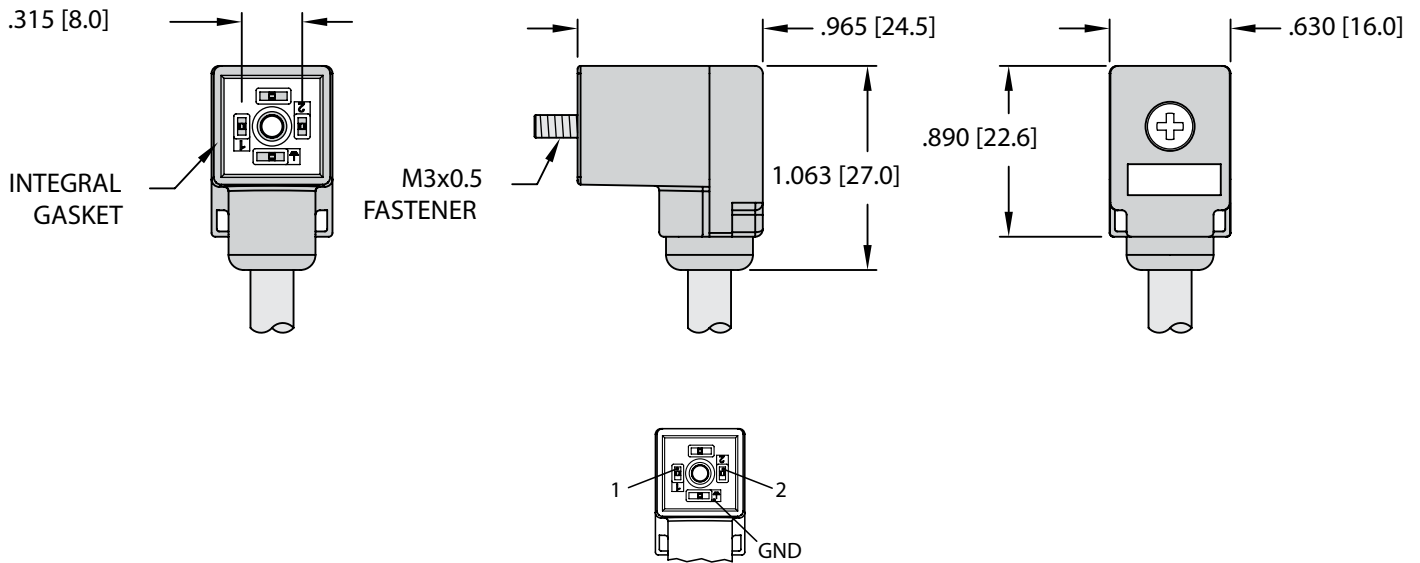

We reserve the right to make technical alterations without prior notice.

### Wiring Diagrams

| Straight Wired (A)                             | Indicator LED (L, M, N)                        | Indicator LED and Suppressor Diodes (P)        |
|--|--|--|
| <p>1 ) _____<br/>2 ) _____<br/>GND ) _____</p> | <p>1 ) _____<br/>2 ) _____<br/>GND ) _____</p> | <p>1 ) _____<br/>2 ) _____<br/>GND ) _____</p> |

# Valve Plug Connectivity

## Valve Connectors, Type "C" (8 mm) Extensions

- Available with PVC and TPU Jackets
- 18 and 24 AWG
- 2 Conductor + Ground (Eurofast®)

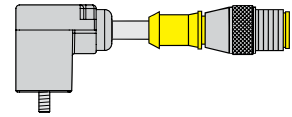

### "C" (8.0 mm) Style Valve Connectors, Eurofast Extension

Eurofast Extension

| Application       | Cable Specs        | Voltage VAC/DC | Straight Wired         | Indicator LED          | Indicator LED and Suppressor Diodes |
|-------------------|--------------------|----------------|------------------------|------------------------|-------------------------------------|
| Standard duty PVC | 3/18 AWG, Grey PVC | 0-220          | TC8S 2-A653-*M-RS 5.3T | ----                   | ----                                |
|                   | 105 °C             | 24             | ----                   | TC8S 2-L653-*M-RS 5.3T | TC8S 2-P653-*M-RS 5.3T              |
|                   | 6.2 mm OD          | 48             | ----                   | TC8S 2-M653-*M-RS 5.3T | ----                                |
|                   | Black Body         | 110            | ----                   | TC8S 2-N653-*M-RS 5.3T | ----                                |
| Standard duty TPU | 3/18 AWG, Grey TPU | 0-220          | TC8S 2-A669-*M-RS 5.3T | ----                   | ----                                |
|                   | 90 °C              | 24             | ----                   | TC8S 2-L669-*M-RS 5.3T | TC8S 2-P669-*M-RS 5.3T              |
|                   | 6.0 mm OD          | 48             | ----                   | TC8S 2-M669-*M-RS 5.3T | ----                                |
|                   | Black Body         | 110            | ----                   | TC8S 2-N669-*M-RS 5.3T | ----                                |

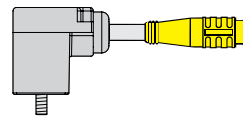

Picofast Snap Extension

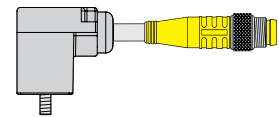

Picofast Threaded Extension

### "C" (8.0 mm) Style Valve Connectors, Picofast® Extension

| Application                   | Cable Specs | Voltage VAC/DC | Straight Wired        | Indicator LED         | Indicator LED and Suppressor Diodes |
|-------------------------------|-------------|----------------|-----------------------|-----------------------|-------------------------------------|
| Small diameter, PVC Snap Lock | 3/24 AWG    | 0-125          | TC8S 2-A642-*M-PSG 3  | ----                  | ----                                |
|                               | Yellow PVC  | 24             | ----                  | TC8S 2-L642-*M-PSG 3  | TC8S 2-P642-*M-PSG 3                |
|                               | 105 °C      | 48             | ----                  | TC8S 2-M642-*M-PSG 3  | ----                                |
| Small diameter, TPU Snap Lock | 3/24 AWG    | 0-125          | TC8S 2-A587-*M-PSG 3  | ----                  | ----                                |
|                               | Black TPU   | 24             | ----                  | TC8S 2-L587-*M-PSG 3  | TC8S 2-P587-*M-PSG 3                |
|                               | 90 °C       | 48             | ----                  | TC8S 2-M587-*M-PSG 3  | ----                                |
| Small diameter, PVC Threaded  | 3/24 AWG    | 0-125          | TC8S 2-A642-*M-PSG 3M | ----                  | ----                                |
|                               | Yellow PVC  | 24             | ----                  | TC8S 2-L642-*M-PSG 3M | TC8S 2-P642-*M-PSG 3M               |
|                               | 105 °C      | 48             | ----                  | TC8S 2-M642-*M-PSG 3M | ----                                |
| Small diameter, TPU Threaded  | 3/24 AWG    | 0-125          | TC8S 2-A587-*M-PSG 3M | ----                  | ----                                |
|                               | Black TPU   | 24             | ----                  | TC8S 2-L587-*M-PSG 3M | TC8S 2-P587-*M-PSG 3M               |
|                               | 90 °C       | 48             | ----                  | TC8S 2-M587-*M-PSG 3M | ----                                |

\* Length in meters.

We reserve the right to make technical alterations without prior notice.



**Type "C" (8 mm) Valve Connector to Eurofast® Extension**

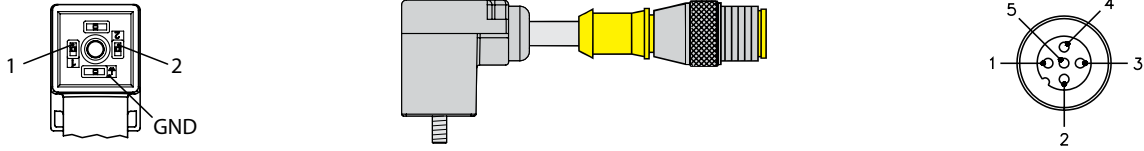

**Wiring Diagrams**

| Straight Wired (A)                       | Indicator LED (L, M, N) | Indicator LED and Suppressor Diodes (P) |
|--|-------------------------|---|
| <p>1 → 4</p> <p>2 → 3</p> <p>GND → 5</p> |                         |   |

**Type "C" (8 mm) Valve Connector to Picofast® Extension**

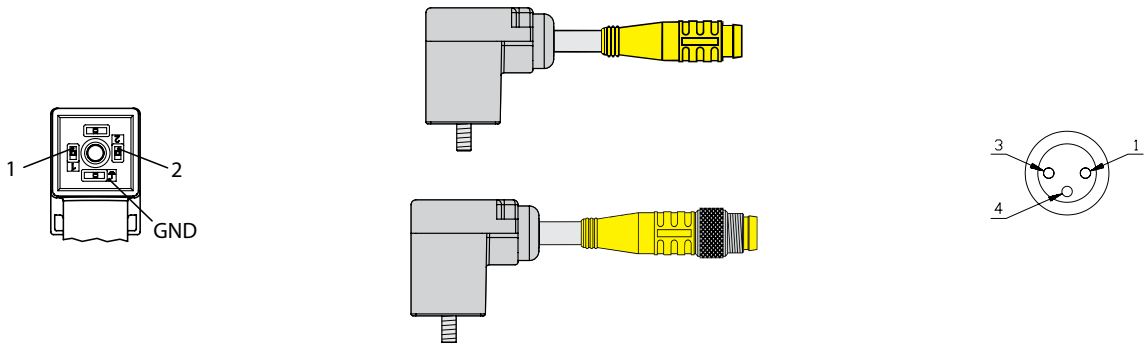

**Wiring Diagrams**

| Straight Wired (A)                        | Indicator LED (L, M) | Indicator LED and Suppressor Diodes (P) |
|---|----------------------|---|
| <p>1 → 4</p> <p>2 → 3</p> <p>GND → NC</p> |                      |   |

# Valve Plug Connectivity

## Valve Connectors, Type "C" (8 mm) Extensions

- Available with PVC and TPU Jackets
- 18 AWG
- 2 Conductor + Ground

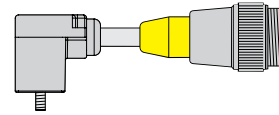

### "C" (8.0 mm) Style Valve Connectors, Minifast® Extension

Minifast Extension

| Application          | Cable Specs        | Voltage VAC/DC | Straight Wired        | Indicator LED         | Indicator LED and Suppressor Diodes |
|----------------------|--------------------|----------------|-----------------------|-----------------------|-------------------------------------|
| Standard duty<br>PVC | 3/18 AWG, Grey PVC | 0-220          | TC8S 2-A653-*M-RSM 30 | ----                  | ----                                |
|                      | 105 °C             | 24             | ----                  | TC8S 2-L653-*M-RSM 30 | TC8S 2-P653-*M-RSM 30               |
|                      | 6.2 mm OD          | 48             | ----                  | TC8S 2-M653-*M-RSM 30 | ----                                |
|                      | Black Body         | 110            | ----                  | TC8S 2-N653-*M-RSM 30 | ----                                |
| Standard duty<br>TPU | 3/18 AWG, Grey TPU | 0-220          | TC8S 2-A669-*M-RSM 30 | ----                  | ----                                |
|                      | 90 °C              | 24             | ----                  | TC8S 2-L669-*M-RSM 30 | TC8S 2-P669-*M-RSM 30               |
|                      | 6.0 mm OD          | 48             | ----                  | TC8S 2-M669-*M-RSM 30 | ----                                |
|                      | Black Body         | 110            | ----                  | TC8S 2-N669-*M-RSM 30 | ----                                |

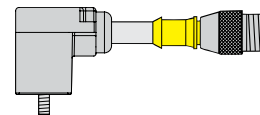

### "C" (8.0 mm) Style Valve Connectors, Microfast® Extension

Microfast Extension

| Application          | Cable Specs        | Voltage VAC/DC | Straight Wired       | Indicator LED        | Indicator LED and Suppressor Diodes |
|----------------------|--------------------|----------------|----------------------|----------------------|-------------------------------------|
| Standard duty<br>PVC | 3/18 AWG, Grey PVC | 0-220          | TC8S 2-A653-*M-SB 3T | ----                 | ----                                |
|                      | 105 °C             | 24             | ----                 | TC8S 2-L653-*M-SB 3T | TC8S 2-P653-*M-SB 3T                |
|                      | 6.2 mm OD          | 48             | ----                 | TC8S 2-M653-*M-SB 3T | ----                                |
|                      | Black Body         | 110            | ----                 | TC8S 2-N653-*M-SB 3T | ----                                |
| Standard duty<br>TPU | 3/18 AWG, Grey TPU | 0-220          | TC8S 2-A669-*M-SB 3T | ----                 | ----                                |
|                      | 90 °C              | 24             | ----                 | TC8S 2-L669-*M-SB 3T | TC8S 2-P669-*M-SB 3T                |
|                      | 6.0 mm OD          | 48             | ----                 | TC8S 2-M669-*M-SB 3T | ----                                |
|                      | Black Body         | 110            | ----                 | TC8S 2-N669-*M-SB 3T | ----                                |

\* Length in meters.

We reserve the right to make technical alterations without prior notice.

Type "C" (8 mm) Valve Connector to Minifast® Extension

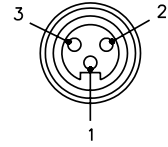
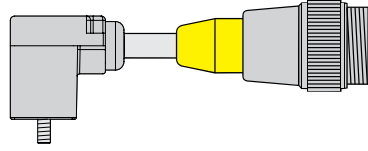
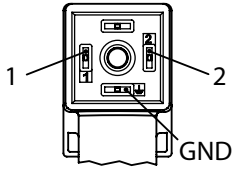

Wiring Diagrams

| Straight Wired (A)   | Indicator LED (L, M) | Indicator LED and Suppressor Diodes (P) |
|--|----------------------|---|
| <p>1 ) —————&gt; 2</p> <p>2 ) —————&gt; 3</p> <p>GND ) —————&gt; 1</p> |                      |   |

Type "C" (8 mm) Valve Connector Microfast® Extension

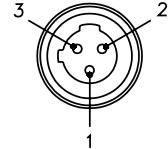
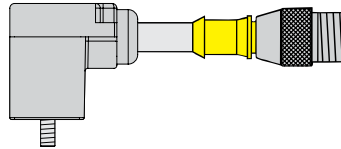
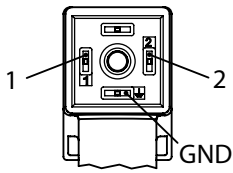

Wiring Diagrams

| Straight Wired (A)   | Indicator LED (L, M) | Indicator LED and Suppressor Diodes (P) |
|--|----------------------|---|
| <p>1 ) —————&gt; 2</p> <p>2 ) —————&gt; 3</p> <p>GND ) —————&gt; 1</p> |                      |   |

# Valve Plug Connectivity

## Valve Connectors, Type "C" (9.4 mm)

- Available with PVC and TPU Jackets
- 18 and 24 AWG
- 2 Conductor + Ground

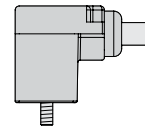

### "C" (9.4 mm) Style Valve Connectors, Standard Color Code

Type C

| Application          | Cable Specs        | Pinout                          | Voltage VAC/DC | Straight Wired | Indicator LED  | Indicator LED and Suppressor Diodes |
|----------------------|--------------------|---------------------------------|----------------|----------------|----------------|-------------------------------------|
| Standard duty<br>PVC | 3/18 AWG, Grey PVC | 1. BK 1<br>2. BK 2<br>Gnd-GN/YE | 0-220          | TC9S 2-A653-*M | ----           | ----                                |
|                      | 105 °C             |                                 | 24             | ----           | TC9S 2-L653-*M | TC9S 2-P653-*                       |
|                      | 6.2 mm OD          |                                 | 48             | ----           | TC9S 2-M653-*M | ----                                |
|                      | Black Body         |                                 | 110            | ----           | TC9S 2-N653-*M | ----                                |
| Standard duty<br>TPU | 3/18 AWG, Grey TPU | 1. BK 1<br>2. BK 2<br>Gnd-GN/YE | 0-220          | TC9S 2-A669-*M | ----           | ----                                |
|                      | 90 °C              |                                 | 24             | ----           | TC9S 2-L669-*M | TC9S 2-P669-*                       |
|                      | 6.0 mm OD          |                                 | 48             | ----           | TC9S 2-M669-*M | ----                                |
|                      | Black Body         |                                 | 110            | ----           | TC9S 2-N669-*M | ----                                |

### "C" (9.4 mm) Style Valve Connectors, IEC Color Code

| Application           | Cable Specs          | Pinout                     | Voltage VAC/DC | Straight Wired | Indicator LED  | Indicator LED and Suppressor Diodes |
|-----------------------|----------------------|----------------------------|----------------|----------------|----------------|-------------------------------------|
| Small diameter<br>PVC | 3/24 AWG, Yellow PVC | 1. BN<br>2. BU<br>Gnd - BK | 0-220          | TC9S 2-A642-*M | ----           | ----                                |
|                       | 105 °C               |                            | 24             | ----           | TC9S 2-L642-*M | TC9S 2-P642-*                       |
|                       | 4.4 mm OD            |                            | 48             | ----           | TC9S 2-M642-*M | ----                                |
|                       | Black Body           |                            | 110            | ----           | TC9S 2-N642-*M | ----                                |
| Small diameter<br>TPU | 3/24 AWG, Black TPU  | 1. BN<br>2. BU<br>Gnd - BK | 0-220          | TC9S 2-A587-*M | ----           | ----                                |
|                       | 90 °C                |                            | 24             | ----           | TC9S 2-L587-*M | TC9S 2-P587-*                       |
|                       | 4.2 mm OD            |                            | 48             | ----           | TC9S 2-M587-*M | ----                                |
|                       | Black Body           |                            | 110            | ----           | TC9S 2-N587-*M | ----                                |

\* Length in meters.

We reserve the right to make technical alterations without prior notice.

### Specifications

- Connectors:** Oil resistant polyurethane body material, Nylon contact carrier.
- Contacts:** Silver plated copper alloy.
- Cable:** See table.
- Cable Length:** Standard cable lengths are nominal 5 meters. Other lengths available by request - consult factory.
- Protection Class:** NEMA 1, 3, 4, 6P and IEC IP 67 when connected and secured.

**Options:** Grey connector body available (special order), change part number TC9S...to TC9G...  
For other combinations or options, consult factory.

### Dimensions

Type C (9.4 mm)

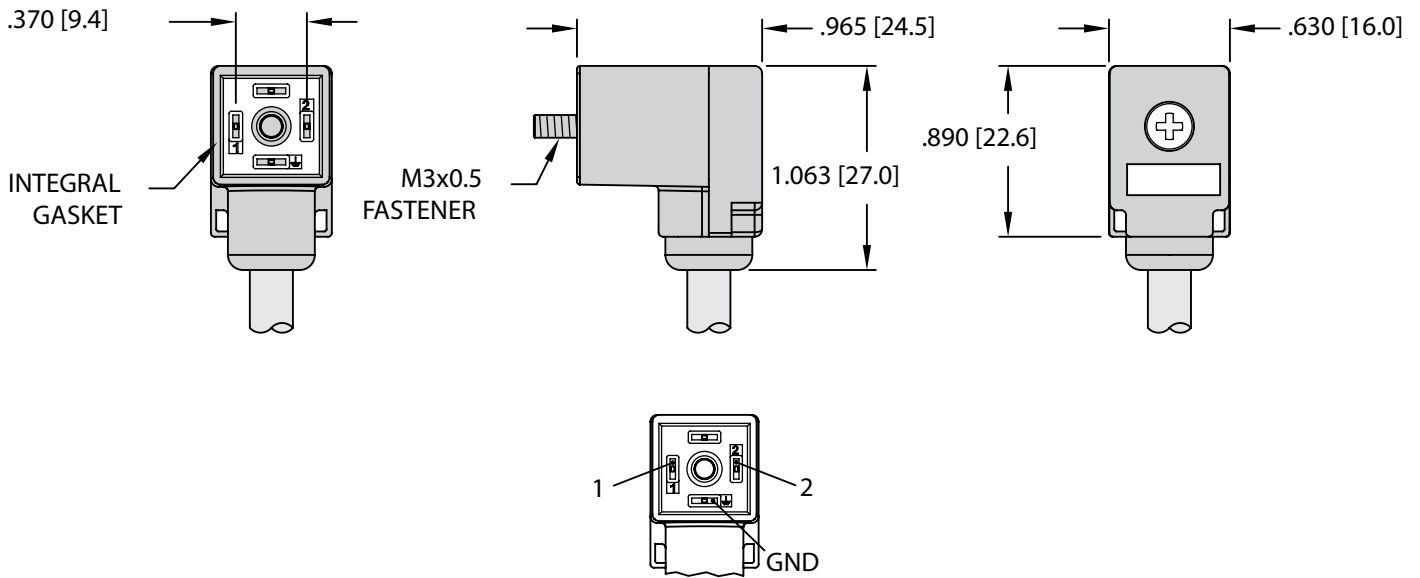

We reserve the right to make technical alterations without prior notice.

### Wiring Diagrams

| Straight Wired (A)                             | Indicator LED (L, M, N)                        | Indicator LED and Suppressor Diodes (P)        |
|--|--|--|
| <p>1 ) _____<br/>2 ) _____<br/>GND ) _____</p> | <p>1 ) _____<br/>2 ) _____<br/>GND ) _____</p> | <p>1 ) _____<br/>2 ) _____<br/>GND ) _____</p> |

# Valve Plug Connectivity

## Valve Connectors, Type "C" (9.4 mm) Extensions

- Available with PVC and TPU Jackets
- 2 Conductor + Ground (Eurofast®)

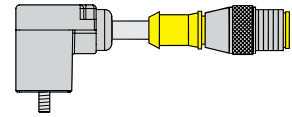

### "C" (9.4 mm) Style Valve Connectors, Eurofast Extension

#### Eurofast Extension

| Application       | Cable Specs        | Voltage VAC/DC | Straight Wired         | Indicator LED          | Indicator LED and Suppressor Diodes |
|-------------------|--------------------|----------------|------------------------|------------------------|-------------------------------------|
| Standard duty PVC | 3/18 AWG, Grey PVC | 0-220          | TC9S 2-A653-*M-RS 5.3T | ----                   | ----                                |
|                   | 105 °C             | 24             | ----                   | TC9S 2-L653-*M-RS 5.3T | TC9S 2-P653-*M-RS 5.3T              |
|                   | 6.2 mm OD          | 48             | ----                   | TC9S 2-M653-*M-RS 5.3T | ----                                |
|                   | Black Body         | 110            | ----                   | TC9S 2-N653-*M-RS 5.3T | ----                                |
| Standard duty TPU | 3/18 AWG, Grey TPU | 0-220          | TC9S 2-A669-*M-RS 5.3T | ----                   | ----                                |
|                   | 90 °C              | 24             | ----                   | TC9S 2-L669-*M-RS 5.3T | TC9S 2-P669-*M-RS 5.3T              |
|                   | 6.0 mm OD          | 48             | ----                   | TC9S 2-M669-*M-RS 5.3T | ----                                |
|                   | Black Body         | 110            | ----                   | TC9S 2-N669-*M-RS 5.3T | ----                                |

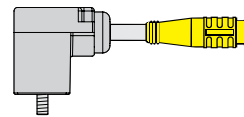

#### Picofast Snap Extension

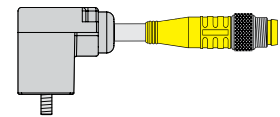

#### Picofast Threaded Extension

### "C" Style Valve Connectors, Picofast® Extension

| Application                   | Cable Specs         | Voltage VAC/DC | Straight Wired        | Indicator LED         | Indicator LED and Suppressor Diodes |
|-------------------------------|---------------------|----------------|-----------------------|-----------------------|-------------------------------------|
| Small diameter, PVC Snap lock | 3/24 AWG Yellow PVC | 0-125          | TC9S 2-A642-*M-PSG 3  | ----                  | ----                                |
|                               | 105 °C              | 24             | ----                  | TC9S 2-L642-*M-PSG 3  | TC9S 2-P642-*M-PSG 3                |
|                               | 4.4 mm OD           | 48             | ----                  | TC9S 2-M642-*M-PSG 3  | ----                                |
| Small diameter, TPU Snap lock | 3/24 AWG Black TPU  | 0-125          | TC9S 2-A587-*M-PSG 3  | ----                  | ----                                |
|                               | 90 °C               | 24             | ----                  | TC9S 2-L587-*M-PSG 3  | TC9S 2-P587-*M-PSG 3                |
|                               | 4.2 mm OD           | 48             | ----                  | TC9S 2-M587-*M-PSG 3  | ----                                |
| Small diameter, PVC Threaded  | 3/24 AWG Yellow PVC | 0-125          | TC9S 2-A642-*M-PSG 3M | ----                  | ----                                |
|                               | 105 °C              | 24             | ----                  | TC9S 2-L642-*M-PSG 3M | TC9S 2-P642-*M-PSG 3M               |
|                               | 4.4 mm OD           | 48             | ----                  | TC9S 2-M642-*M-PSG 3M | ----                                |
| Small diameter, TPU Threaded  | 3/24 AWG Black TPU  | 0-125          | TC9S 2-A587-*M-PSG 3M | ----                  | ----                                |
|                               | 90 °C               | 24             | ----                  | TC9S 2-L587-*M-PSG 3M | TC9S 2-P587-*M-PSG 3M               |
|                               | 4.2 mm OD           | 48             | ----                  | TC9S 2-M587-*M-PSG 3M | ----                                |

\* Length in meters.

We reserve the right to make technical alterations without prior notice.

Type "C" (9.4 mm) Valve Connector to Eurofast® Extension

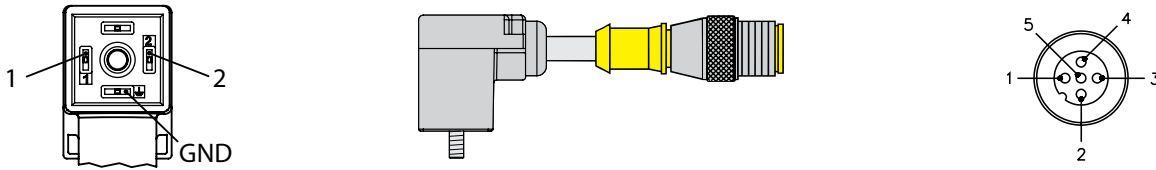

Wiring Diagrams

| Straight Wired (A)                       | Indicator LED (L, M, N) | Indicator LED and Suppressor Diodes (P) |
|--|-------------------------|---|
| <p>1 → 4</p> <p>2 → 3</p> <p>GND → 5</p> |                         |   |

Type "C" (9.4 mm) Valve Connector to Picofast® Extension

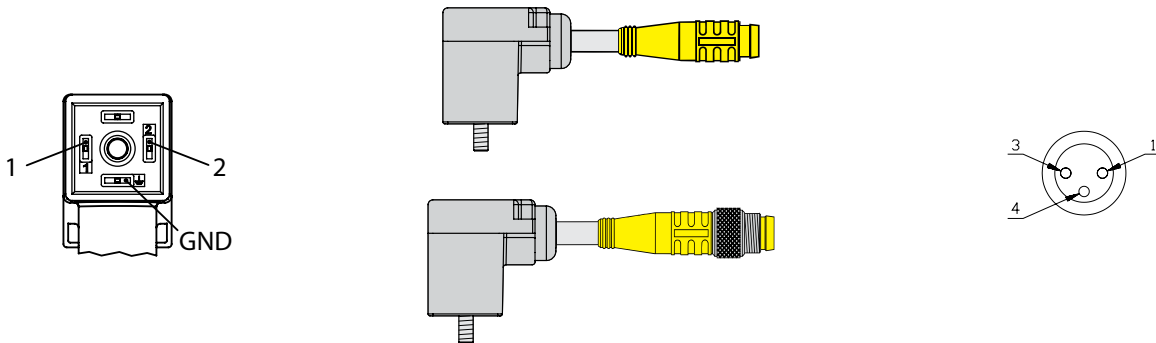

Wiring Diagrams

| Straight Wired (A)                        | Indicator LED (L, M) | Indicator LED and Suppressor Diodes (P) |
|---|----------------------|---|
| <p>1 → 4</p> <p>2 → 3</p> <p>GND → NC</p> |                      |   |

# Valve Plug Connectivity

## Valve Connectors, Type "C" (9.4 mm) Extensions

- Available with PVC and TPU Jackets
- 18 AWG
- 2 Conductor + Ground

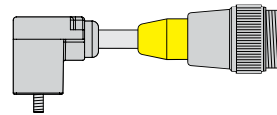

### "C" (9.4 mm) Style Valve Connectors, Minifast® Extension

Minifast Extension

| Application          | Cable Specs        | Voltage VAC/DC | Straight Wired        | Indicator LED         | Indicator LED and Suppressor Diodes |
|----------------------|--------------------|----------------|-----------------------|-----------------------|-------------------------------------|
| Standard duty<br>PVC | 3/18 AWG, Grey PVC | 0-220          | TC9S 2-A653-*M-RSM 30 | ----                  | ----                                |
|                      | 105 °C             | 24             | ----                  | TC9S 2-L653-*M-RSM 30 | TC9S 2-P653-*M-RSM 30               |
|                      | 6.2 mm OD          | 48             | ----                  | TC9S 2-M653-*M-RSM 30 | ----                                |
|                      | Black Body         | 110            | ----                  | TC9S 2-N653-*M-RSM 30 | ----                                |
| Standard duty<br>TPU | 3/18 AWG, Grey TPU | 0-220          | TC9S 2-A669-*M-RSM 30 | ----                  | ----                                |
|                      | 90 °C              | 24             | ----                  | TC9S 2-L669-*M-RSM 30 | TC9S 2-P669-*M-RSM 30               |
|                      | 6.0 mm OD          | 48             | ----                  | TC9S 2-M669-*M-RSM 30 | ----                                |
|                      | Black Body         | 110            | ----                  | TC9S 2-N669-*M-RSM 30 | ----                                |

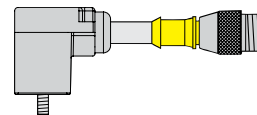

### "C" (9.4 mm) Style Valve Connectors, Microfast® Extension

Microfast Extension

| Application          | Cable Specs        | Voltage VAC/DC | Straight Wired       | Indicator LED        | Indicator LED and Suppressor Diodes |
|----------------------|--------------------|----------------|----------------------|----------------------|-------------------------------------|
| Standard duty<br>PVC | 3/18 AWG, Grey PVC | 0-220          | TC9S 2-A653-*M-SB 3T | ----                 | ----                                |
|                      | 105 °C             | 24             | ----                 | TC9S 2-L653-*M-SB 3T | TC9S 2-P653-*M-SB 3T                |
|                      | 6.2 mm OD          | 48             | ----                 | TC9S 2-M653-*M-SB 3T | ----                                |
|                      | Black Body         | 110            | ----                 | TC9S 2-N653-*M-SB 3T | ----                                |
| Standard duty<br>TPU | 3/18 AWG, Grey TPU | 0-220          | TC9S 2-A669-*M-SB 3T | ----                 | ----                                |
|                      | 90 °C              | 24             | ----                 | TC9S 2-L669-*M-SB 3T | TC9S 2-P669-*M-SB 3T                |
|                      | 6.0 mm OD          | 48             | ----                 | TC9S 2-M669-*M-SB 3T | ----                                |
|                      | Black Body         | 110            | ----                 | TC9S 2-N669-*M-SB 3T | ----                                |

\* Length in meters.

We reserve the right to make technical alterations without prior notice.



Type "C" (9.4 mm) Valve Connector to Minifast® Extension

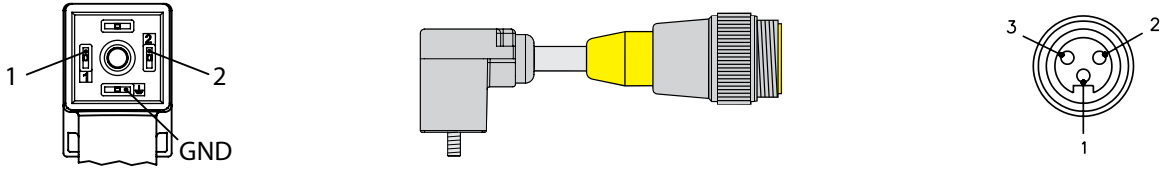

Wiring Diagrams

| Straight Wired (A)   | Indicator LED (L, M, N) | Indicator LED and Suppressor Diodes (P) |
|--|-------------------------|---|
| <p>1 ) —————&gt; 2</p> <p>2 ) —————&gt; 3</p> <p>GND ) —————&gt; 1</p> |                         |   |

Type "C" (9.4 mm) Valve Connector to Microfast® Extension

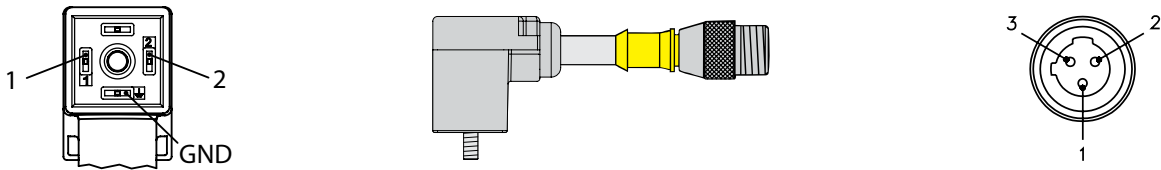

Wiring Diagrams

| Straight Wired (A)   | Indicator LED (L, M, N) | Indicator LED and Suppressor Diodes (P) |
|--|-------------------------|---|
| <p>1 ) —————&gt; 2</p> <p>2 ) —————&gt; 3</p> <p>GND ) —————&gt; 1</p> |                         |   |

# Valve Plug Connectivity

## Valve Connectors w/Integral Eurofast® or Picofast® Connector

- Integral Eurofast and Picofast Connectors
- Compact Size
- 2 Conductor + Ground (Eurofast)

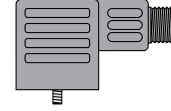

### “A” Style Valve Connectors, Integral Eurofast Connector

Eurofast

| Application   | Pinout | Voltage VAC/DC | Straight Wired          | Indicator LED | Indicator LED and MOV   |
|---|--------|----------------|-------------------------|---------------|-------------------------|
| “A” Style Connector with Integral Eurofast connector<br>2 Conductors, 1 Ground<br>Ground contacts<br>Parallel wired |        | 0-220<br>24-48 | VAS 22-A-FS 5.3<br>---- | ----<br>----  | ----<br>VAS 22-D-FS 5.3 |

\* Length in meters.



We reserve the right to make technical alterations without prior notice.

### Specifications

- Specifications:** Oil resistant polyurethane body material, Nylon valve plug contact carrier, TPU Eurofast contact carrier.
- Contacts:** Valve plug: silver plated copper alloy; Eurofast: gold plated brass.
- Temperature:** -30 °C to +80 °C (-22 °F to +176 °F).
- Protection Class:** NEMA 1, 3, 4, 6P and IEC IP 67 when connected and secured.

### Dimensions

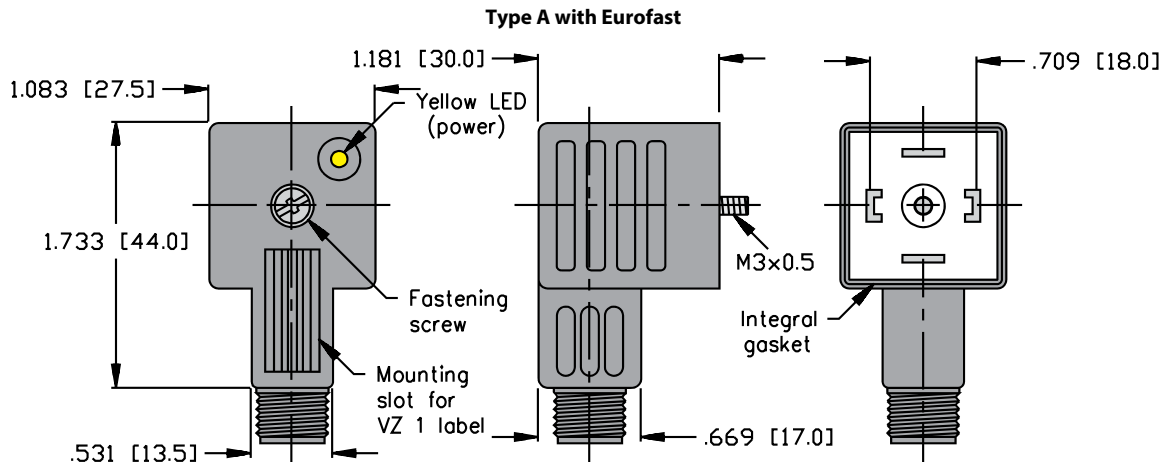

### Wiring Diagrams

| Straight Wired (A) | Indicator LED (L, M, N) | Indicator LED and Suppressor Diodes (P) |
|--------------------|-------------------------|---|
|                    |                         |   |

We reserve the right to make technical alterations without prior notice.

Valve Plug

# Valve Plug Connectivity

## Eurofast® 2 Branch Splitters with Valve Plugs

- Combine 2 Valve Plugs into 1 Eurofast
- For Use w/Eurofast J-boxes w/2 Signals/Port
- Available with All Valve Plug Styles (A, B, I and C)

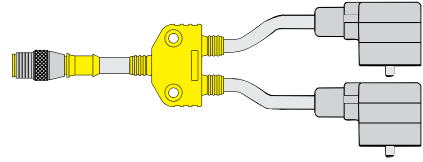

### 4-wire Series-Wired VB2

| Application   | Specifications  | Wiring Diagram   | Part Number                    |
|---|---|------------------|--------------------------------|
| Combine 2 valve plugs into 1 cable. For use with 2 signal / port junction boxes.<br>"A" style (18 mm) valve plugs.  | 220 VAC/DC<br>4.0 A<br>RS 4.5T = Grey PVC,<br>5.3 mm OD, 4/22 AWG<br>Valve plug = Grey PVC, 6.2 mm OD<br>3/18 AWG | <b>Diagram A</b> | VB2-RS 4.5T-*/2VAS 22-A653-*/* |
| Combine 2 valve plugs into 1 cable. For use with 2 signal / port junction boxes.<br>"B" style (10 mm) valve plugs.  | 220 VAC/DC<br>4.0 A<br>RS 4.5T = Grey PVC<br>5.3 mm OD, 4/22 AWG<br>Valve plug = Grey PVC, 6.2 mm OD<br>3/18 AWG  | <b>Diagram A</b> | VB2-RS 4.5T-*/2VBS 2-A653-*/*  |
| Combine 2 valve plugs into 1 cable. For use with 2 signal / port junction boxes.<br>"I" style (11 mm) valve plugs.  | 220 VAC/DC<br>4.0 A<br>RS 4.5T = Grey PVC,<br>5.3 mm OD, 4/22 AWG<br>Valve plug = Grey PVC, 6.2 mm OD<br>3/18 AWG | <b>Diagram A</b> | VB2-RS 4.5T-*/2VIS 2-A653-*/*  |
| Combine 2 valve plugs into 1 cable. For use with 2 signal / port junction boxes.<br>"C" style (8 mm) valve plugs.   | 220 VAC/DC<br>4.0 A<br>RS 4.5T = Grey PVC,<br>5.3 mm OD, 4/22 AWG<br>Valve plug = Grey PVC, 6.2 mm OD<br>3/18 AWG | <b>Diagram A</b> | VB2-RS 4.5T-*/2TC8S 2-A653-*/* |
| Combine 2 valve plugs into 1 cable. For use with 2 signal / port junction boxes.<br>"C" style (9.4 mm) valve plugs. | 220 VAC/DC<br>4.0 A<br>RS 4.5T = Grey PVC,<br>5.3 mm OD, 4/22 AWG<br>Valve plug = Grey PVC, 6.2 mm OD<br>3/18 AWG | <b>Diagram A</b> | VB2-RS 4.5T-*/2TC9S 2-A653-*/* |

We reserve the right to make technical alterations without prior notice.

\* Length in meters.

### Diagram A

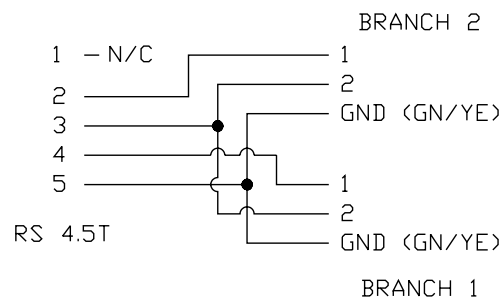

### Specifications

|                       |   |                       |   |
|-----------------------|---|-----------------------|---|
| <b>Junction Body:</b> | Oil resistant Yellow polyurethane.                                      | <b>Coupling Nuts:</b> | Nickel plated brass.  |
| <b>Connector:</b>     | Oil resistant polyurethane body material, Nylon or TPU contact carrier. | <b>Cable:</b>         | See table.  |
| <b>Contacts:</b>      | Gold plated brass (Eurofast). Silver plated copper alloy (V*fast).      | <b>Temperature:</b>   | -40 °C to +105 °C (-40 °F to +221 °F) - all PVC cable; -40 °C to +90 °C (-40 °F to +194 °F) - with TPU cable. |
|                       |   | <b>Protection:</b>    | NEMA 1, 3, 4, 6P and IEC IP 68.   |

- Cable Length:** Trunk - nominal 1 meter. Branches - nominal 0.3 meters. Other lengths available by request - consult factory.
- Cable Options:** Other jackets available by request - consult factory.
- Valve Options:** Available w/LED or LED+mov, consult factory.
- Eurofast® Options:** Stainless steel coupling nut add "V" to part number (RS .. to RSV ..). Nylon coupling nut add "K" to part number (RS .. to RSK ..). Right angle connectors, change part number (RS .. to WS..).

### Dimensions

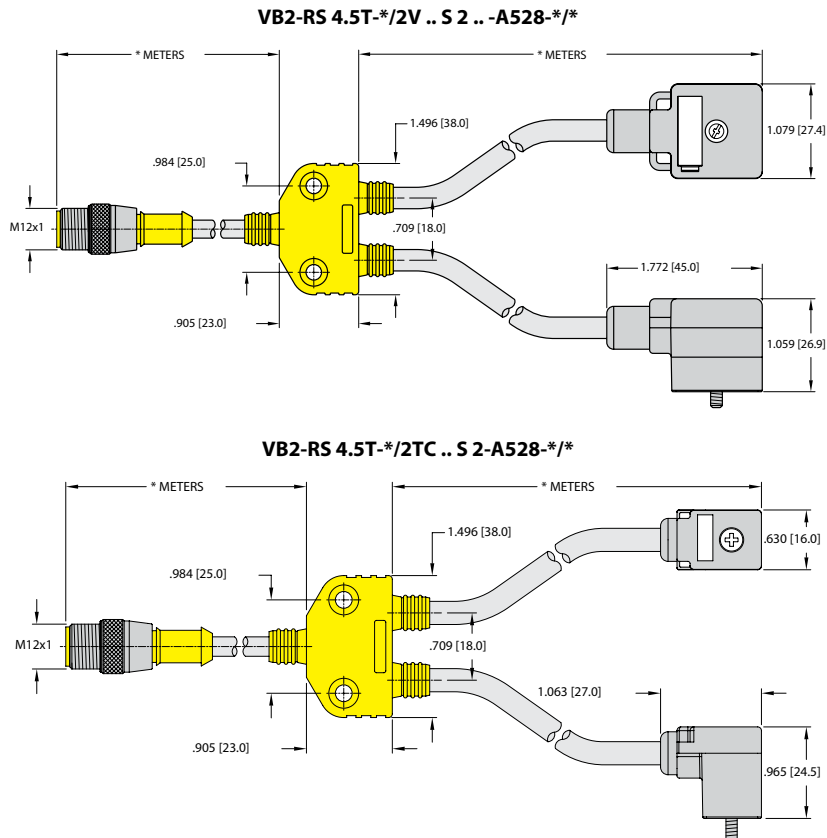

### Pinout

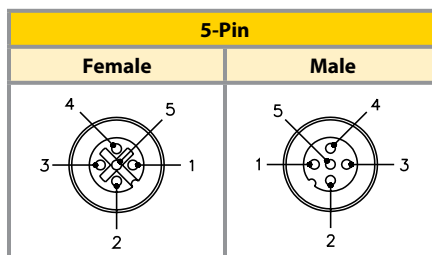

We reserve the right to make technical alterations without prior notice.

Valve Plug

# Valve Plug Connectivity

## Valve Connectors, Field Wireables

- Convert Hard Wiring Into Quick Disconnect
- Facilitate Field Replacements

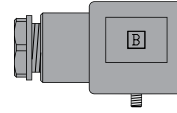

### "A" Style Valve Connector

| Application               | Specifications     | Straight Wired |
|---------------------------|--------------------|----------------|
| "A" Style Valve Connector | 0-220 VAC/DC, 10 A | VAS 3-AW       |

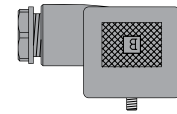

### "B" Style Valve Connector

| Application               | Specifications     | Straight Wired |
|---------------------------|--------------------|----------------|
| "B" Style Valve Connector | 0-220 VAC/DC, 10 A | VBS 2-AW       |

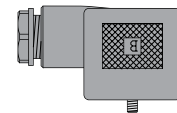

### "I" Style Valve Connector

| Application               | Specifications     | Straight Wired |
|---------------------------|--------------------|----------------|
| "I" Style Valve Connector | 0-220 VAC/DC, 10 A | VIS 2-AW       |

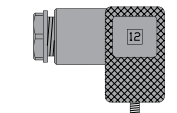

### "C" (8 mm) Style Valve Connector

| Application                      | Specifications     | Straight Wired |
|----------------------------------|--------------------|----------------|
| "C" (8 mm) Style Valve Connector | 0-220 VAC/DC, 10 A | TC8S 2-AW      |

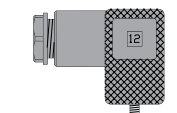

### "C" (9.4 mm) Style Valve Connector

| Application                        | Specifications     | Straight Wired |
|------------------------------------|--------------------|----------------|
| "C" (9.4 mm) Style Valve Connector | 0-220 VAC/DC, 10 A | TC9S 2-AW      |

We reserve the right to make technical alterations without prior notice.

### Specifications

|                    |  |                          |   |
|--------------------|--|--------------------------|---|
| <b>Housing:</b>    | Nylon, black.                          | <b>Cable Gland:</b>      | PG 9 accepts cable diameter 6-8 mm. PG 7 accepts cable diameter 4-6 mm. |
| <b>Connectors:</b> | Nylon, black.                          | <b>Temperature:</b>      | -25 °C to +90 °C (-13 °F to +194 °F).                                   |
| <b>Gasket:</b>     | Nitrile.                               | <b>Protection Class:</b> | NEMA 4, 6P and IEC IP 65.   |
| <b>Contacts:</b>   | Nickel plated brass                    |                          |   |
| <b>Terminals:</b>  | Screw terminals, conductors to 14 AWG. |                          |   |

### Dimensions

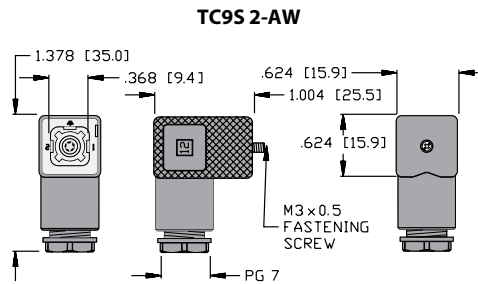
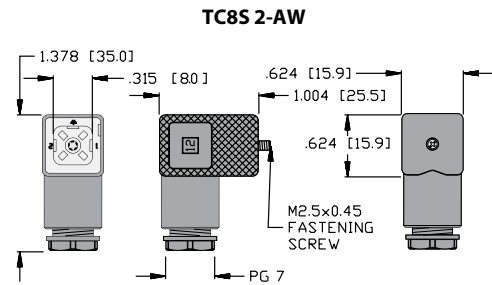
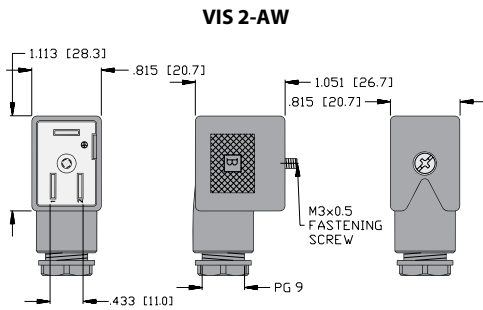
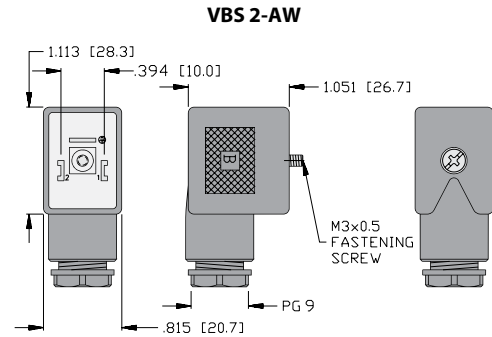
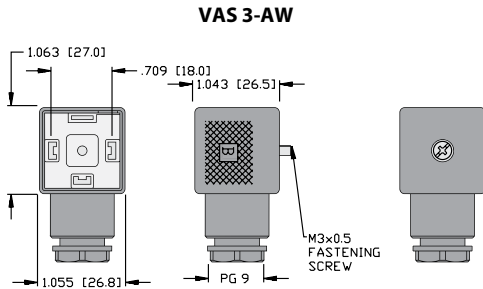

We reserve the right to make technical alterations without prior notice.





|                           |           |
|---------------------------|-----------|
| <b>Cable Glands</b>       | <b>U2</b> |
| <b>Strain Relief</b>      | <b>U5</b> |
| <b>Snap-In Labels</b>     | <b>U5</b> |
| <b>Lock Nuts</b>          | <b>U6</b> |
| <b>Torque Wrench</b>      | <b>U7</b> |
| <b>Protective Sleeves</b> | <b>U8</b> |

**Features**

- NPT and PG thread cable glands in nylon or metal materials
- Locknuts in multiple thread sizes for receptacle mounting
- M12/M8 torque tool
- Fiberglass and silicone sleeving
- Customizable labels



### Liquid Tight Nylon Strain Relief Cable Glands

#### Communication Rate/Cycle Time

Whenever a metal strain relief cable gland is used, this Nylon Strain Relief Cable Gland can be substituted to save you money without sacrificing performance. Typical applications are: Control cabinets, car washes, hot tubs, instrumentation, carpet cleaning machines, food processing equipment, underground for direct burial, and underwater to 300 ft. (150 PSIG).



#### Pull-out Resistance - Protection

Flexible, overlapping clamping splines prevent the form seal from being pulled out of the fitting and offers protection for the cable.

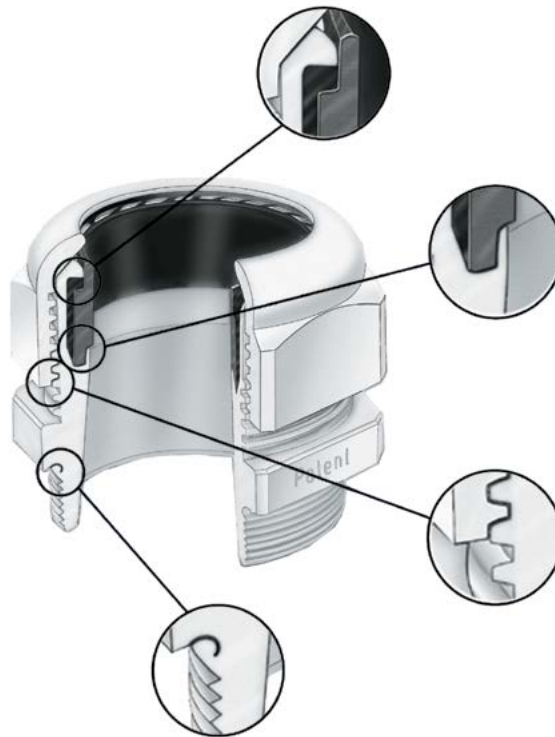

#### Dependable

Exceeds NEMA 4x and 6 specifications (UL tested). For submersion applications, use an O-Ring or Seal Ring between body and housing. Either tap the housing or secure in panel hole with Locking Nut.

#### Non-Corrosive

The Nylon strain relief cable glands are resistant to salt water, weak acids, weak alkalis, alcohol, esters, ketones, ether, gasoline, mineral, animal and vegetable oil.

#### Submersible

The patented recess and high performance seal guarantees NEMA 4x and 6 (IP 68) at 150 PSIG (10 BAR).

#### Rugged Construction

The rugged lead screw results in a dependable transmission of force between nut and body.

#### Liquid Tight

The concentric seal ridge and molded groove for an optional O-Ring results in a liquid tight seal between body and housing.



#### EMI/RFI Proof-Grounded

- Termination of the braided shield
- Strip cable jacket and braiding to different lengths
- For small diameter cables, fold the braided shield back over the cable jacket
- Insert cable into fitting until it reaches contact point
- Tighten dome nut

PG/NPT Threads - Nylon/Straight

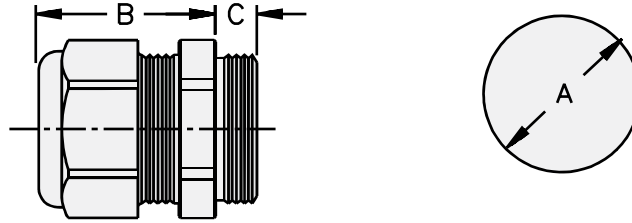

| Part Number              | Cable Range | Thread Type | Clearance Hole (A) | Body Length (B) | Thread Length (C) |
|--------------------------|-------------|-------------|--------------------|-----------------|-------------------|
| CG-PG7STRT-NYLON 3-6.5MM | 3 to 6.5 mm | PG7         | 12.5 mm            | 20 mm           | 8 mm              |
| CG-PG9STRT-NYLON 4-8MM   | 4 to 8 mm   | PG9         | 15.2 mm            | 22 mm           | 8 mm              |
| CG-PG11STRT-NYLON 5-10MM | 5 to 10 mm  | PG11        | 18.5 mm            | 24 mm           | 8 mm              |
| CG-3/8STRT-NYLON 2-6MM   | 2 to 6 mm   | 3/8" NPT    | 17.2 mm            | 22 mm           | 15 mm             |
| CG-1/2STRT-NYLON 5-9MM   | 5 to 9 mm   | 1/2" NPT    | 21.1 mm            | 27 mm           | 13 mm             |
| CG-1/2STRT-NYLON 10-14MM | 10 to 14 mm | 1/2" NPT    | 21.1 mm            | 28 mm           | 13 mm             |
| CG-3/4STRT-NYLON 9-16MM  | 9 to 16 mm  | 3/4" NPT    | 26.7 mm            | 30 mm           | 13 mm             |

We reserve the right to make technical alterations without prior notice.

PG/NPT Threads - Metal/Straight

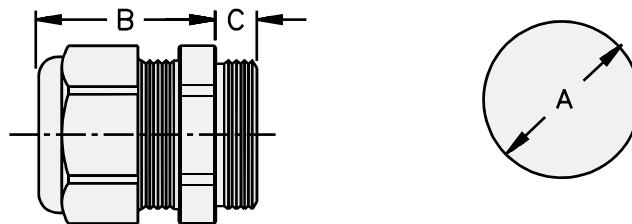

| Part Number              | Cable Range | Thread Type | Clearance Hole (A) | Body Length (B) | Thread Length (C) |
|--------------------------|-------------|-------------|--------------------|-----------------|-------------------|
| CG-PG7STRT-METAL 3-6.5MM | 3 to 6.5 mm | PG7         | 12.5 mm            | 19 mm           | 5 mm              |
| CG-PG9STRT-METAL 4-8MM   | 4 to 8 mm   | PG9         | 15.2 mm            | 21 mm           | 6 mm              |
| CG-PG11STRT-METAL 5-10MM | 5 to 10 mm  | PG11        | 18.5 mm            | 22 mm           | 6 mm              |
| CG-3/8STRT-METAL 4-8MM   | 4 to 8 mm   | 3/8" NPT    | 17.2 mm            | 21 mm           | 15 mm             |
| CG-1/2STRT-METAL 6-12MM  | 6 to 12 mm  | 1/2" NPT    | 21.1 mm            | 24 mm           | 13 mm             |
| CG-3/4STRT-METAL 13-18MM | 13 to 18 mm | 3/4" NPT    | 26.7 mm            | 25 mm           | 13 mm             |

Accessories

# Connectivity Products

## SHIELDED - PG/NPT Threads - Metal/Straight

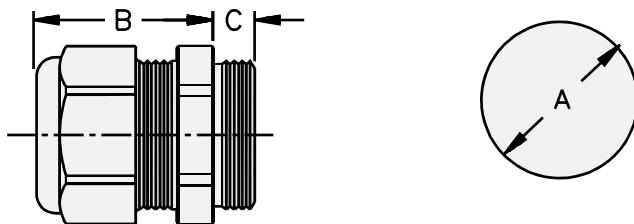

| Part Number               | Cable Range | Thread Type | Clearance Hole (A) | Body Length (B) | Thread Length (C) |
|---------------------------|-------------|-------------|--------------------|-----------------|-------------------|
| CG-3/8STRT-SHLDMTL 4-8MM  | 4 to 8 mm   | 3/8" NPT    | 17.2 mm            | 20 mm           | 15 mm             |
| CG-1/2STRT-SHLDMTL 6-12MM | 6 to 12 mm  | 1/2" NPT    | 21.1 mm            | 22 mm           | 13 mm             |
| CG-3/4STRT-SHLDMTL 9-16MM | 9 to 16 mm  | 3/4" NPT    | 26.7 mm            | 29 mm           | 13 mm             |

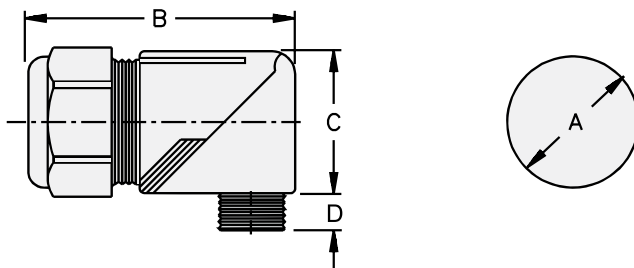

## PG/NPT Threads - Nylon/Right Angle



| Part Number               | Cable Range | Thread Type | Clearance Hole (A) | Body Length (B) | Height (C) | Thread Length (D) |
|---------------------------|-------------|-------------|--------------------|-----------------|------------|-------------------|
| CG-PG9ANGLE-NYLON 4-8MM   | 4 to 8 mm   | PG 9        | 15.2 mm            | 45 mm           | 23 mm      | 8 mm              |
| CG-3/8ANGLE-NYLON 4-8MM   | 4 to 8 mm   | 3/8" NPT    | 17.2 mm            | 45 mm           | 23 mm      | 15 mm             |
| CG-1/2ANGLE-NYLON 5-9MM   | 5 to 9 mm   | 1/2" NPT    | 21.1 mm            | 57 mm           | 30.5 mm    | 13 mm             |
| CG-1/2ANGLE-NYLON 10-14MM | 10 to 14 mm | 1/2" NPT    | 21.1 mm            | 65 mm           | 32.5 mm    | 13 mm             |
| CG-3/4ANGLE-NYLON 9-16MM  | 9 to 16 mm  | 3/4" NPT    | 26.7 mm            | 73 mm           | 40 mm      | 13 mm             |

We reserve the right to make technical alterations without prior notice.

Strain Relief Cord Grips

| Part Number       | Specifications  | Application             | Drawing   |
|-------------------|---|-------------------------|---|
| <b>SRF-PG11</b>   | Nylon<br>PG 11 threads<br>Accepts cable diameter .200-.394"<br>IP 68<br>-30 °C to +100 °C   | Strain relief cord grip |  |
| <b>SRF-PG13.5</b> | Nylon<br>PG 13.5 threads<br>Accepts cable diameter .236-.472"<br>IP 68<br>-30 °C to +100 °C | Strain relief cord grip |  |

Snap-in Labels

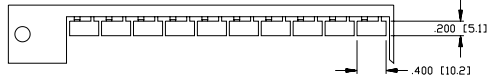
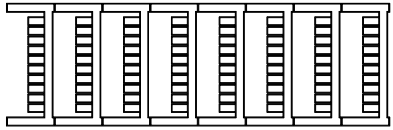
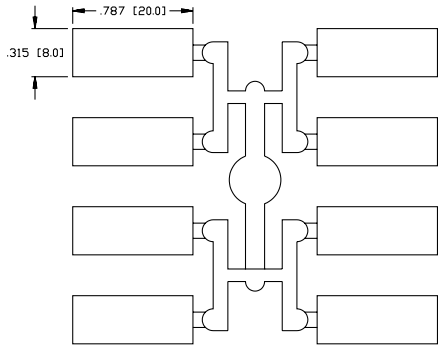
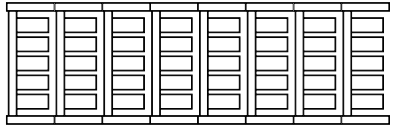
| Part Number  | Specifications                                      | Application   | Drawing   |
|--|---|---|---|
| <b>KS 5/10 (10/Labels)</b>                                     | 10 white labels<br>5x10 mm each                     | Snap-in labels for VBRS and VBRK splitters and Eurofast® to Picofast® adapters and junction boxes |   |
| <b>Custom printed labels (Consult factory for part number)</b> | 1 sheet minimum<br>80 white labels,<br>5x10 mm each |   |  |
| <b>VZ 1 (8/labels)</b>   | 8 white labels<br>8x20 mm each<br>Nylon             | Snap-in labels for Eurofast and Microfast® junction boxes, V*fast®                                |  |
| <b>Custom printed labels (Consult factory for part number)</b> | 1 sheet minimum<br>40 white labels,<br>8x20 mm each |   |  |

We reserve the right to make technical alterations without prior notice.

Accessories

# Connectivity Products



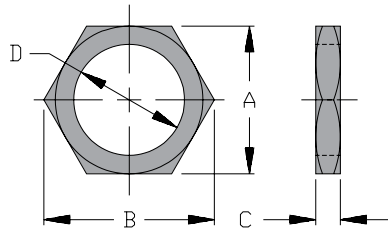

## Lock Nuts

| Part Number                          | Specifications                                      | Application  | A                | B                | C               | D       |
|--------------------------------------|---|--|------------------|------------------|-----------------|---------|
| <b>LOCKNUT-PG 9 Metal (5/Bag)</b>    | Nickel plated brass<br>PG 9 threads<br>5 per bag    | Lock nut Eurofast®<br>receptacles                            | 0.71"<br>18.0 mm | 0.79"<br>20.0 mm | 0.11"<br>2.8 mm | PG 9    |
| <b>LOCKNUT-PG 13.5 Metal (5/Bag)</b> | Nickel plated brass<br>PG 13.5 threads<br>5 per bag | Lock nut Eurofast<br>receptacles                             | 0.90"<br>23.0 mm | 1.00"<br>25.5 mm | 0.12"<br>3.0 mm | PG 13.5 |
| <b>LOCKNUT 1/4-18 (10/Bag)</b>       | Nickel plated brass<br>1/4-18 threads<br>10 per bag | Lock nut Eurofast<br>and Microfast®<br>receptacles           | 0.69"<br>17.5 mm | 0.79"<br>20.0 mm | 0.16"<br>4.0 mm | 1/4-18  |
| <b>LOCKNUT 1/2-14 Hex (10/Bag)</b>   | Die-cast Zinc<br>½-14 threads<br>10 per bag         | Lock nut Minifast®,<br>Eurofast and<br>Microfast receptacles | 0.94"<br>24.0 mm | 1.1"<br>27.5 mm  | 0.16"<br>4.0 mm | 1/2-14  |



We reserve the right to make technical alterations without prior notice.

Torque Wrench

| Picture  | Part Number  | Specifications  |
|--|--|---|
| <p data-bbox="386 296 440 317">Base</p>  <p data-bbox="334 638 492 659">Torque Adjuster</p>  <p data-bbox="367 968 459 989">M8 Insert</p>  <p data-bbox="362 1289 464 1310">M12 Insert</p>  | <p data-bbox="691 926 1040 947">SCREWTY M8/M12 TORQUE WRENCH</p> | <p data-bbox="1118 827 1487 873">For tightening and loosening of Eurofast® and Picofast® connectors</p> <p data-bbox="1118 911 1328 961"><b>M8 Torque:</b><br/>Recommended: 0.5 Nm</p> <p data-bbox="1118 999 1328 1050"><b>M12 Torque:</b><br/>Recommended: 0.8 Nm</p> |

We reserve the right to make technical alterations without prior notice.

Accessories



# Connectivity Products

## Braided Fiberglass Sleeving Viton Coated (Bulk)



| Part Number  | Specifications  | Application                                  | Features   |
|--|---|--|--|
| <b>FFV 1/4INCH BLACK 50 FOOT ROLL</b> <sup>†</sup><br><b>FFV 1/4INCH BLACK (10/BAG-6IN)</b> <sup>†</sup>     | Viton (fluoroelastomer) coated, braided fiberglass, black<br>1/4" diameter -70 °C to +220 °C<br>NEMA TF-1   | Protective sleeving for insulation of cable. | Excellent chemical and solvent resistance, coating offers improved flexibility and protection throughout a wide operating temperature range. |
| <b>FFV 3/8INCH BLACK 50 FOOT ROLL</b> <sup>†</sup><br><b>FFV 3/8INCH BLACK (10/BAG-6IN)</b> <sup>†</sup>     | Viton (fluoroelastomer) coated, braided fiberglass, black<br>3/8" diameter -70 °C to +220 °C<br>NEMA TF-1   |  |  |
| <b>FFV 1/2INCH BLACK 50 FOOT ROLL</b> <sup>†</sup><br><b>FFV 1/2INCH BLACK (10/BAG-6IN)</b> <sup>†</sup>     | Viton (fluoroelastomer) coated, braided fiberglass, black<br>1/2" diameter -70 °C to +220 °C<br>NEMA TF-1   |  |  |
| <b>FFV 5/8INCH BLACK 50 FOOT ROLL</b> <sup>†</sup><br><b>FFV 5/8INCH BLACK (10/BAG-6IN)</b> <sup>†</sup>     | Viton (fluoroelastomer) coated, braided fiberglass, black<br>5/8" diameter -70 °C to +220 °C<br>NEMA TF-1   |  |  |
| <b>FFV 1INCH BLACK 50 FOOT ROLL</b> <sup>†</sup><br><b>FFV 1INCH BLACK (10/BAG-6IN)</b> <sup>†</sup>         | Viton (fluoroelastomer) coated, braided fiberglass, black<br>1" diameter -70 °C to +220 °C<br>NEMA TF-1     |  |  |
| <b>FFV 1 1/2INCH BLACK 50 FOOT ROLL</b> <sup>†</sup><br><b>FFV 1 1/2INCH BLACK (10/BAG-6IN)</b> <sup>†</sup> | Viton (fluoroelastomer) coated, braided fiberglass, black<br>1 1/2" diameter -70 °C to +220 °C<br>NEMA TF-1 |  |  |

We reserve the right to make technical alterations without prior notice.

## Braided Fiberglass Sleeving Acryl-Coated (Bulk)

| Part Number  | Specifications  | Application                                  | Features                                   |
|--|---|--|--|
| <b>FF 3/4INCH BLACK (10/BAG)</b> <sup>†</sup><br><b>FF 3/4INCH BLACK 50 FOOT ROLL</b> <sup>†</sup> | Acryl-coated braided fiberglass<br>3/4" diameter -70 °C to +240 °C<br>NEMA TF-1 | Protective sleeving for insulation of cable. | Excellent chemical and solvent resistance. |
| <b>FF 1/2INCH BLACK (10/BAG)</b> <sup>†</sup><br><b>FF 1/2INCH BLACK 50 FOOT ROLL</b> <sup>†</sup> | Acryl-coated braided fiberglass<br>1/2" diameter -70 °C to +240 °C<br>NEMA TF-1 |  |  |

<sup>†</sup> Sleeving part numbers only; cordset not included.



Expandable Silicone Rubber Coated, Fiberglass Sleeving (Bulk)



| Part Number   | Specifications  | Application  | Features   |
|---|---|--|--|
| <b>FFFS WHT ID 3/8-INCH-30M<sup>†</sup></b><br><b>FFFS WHT ID 3/8-INCH (10/BAG-6IN)<sup>†</sup></b> | Fiberglass braid, silicone rubber coating, white 3/8" diameter, -55 °C to +200 °C NEMA TF-1 | Expandable silicone coated fiberglass sleeving for protection of cable and coupling nut. | "Heat shrink" like fit with abrasion, moisture, cut-through chemical and weld slag resistance. |
| <b>FFFS WHT ID 5/8-INCH-30M<sup>†</sup></b><br><b>FFFS WHT ID 5/8-INCH (10/BAG-6IN)<sup>†</sup></b> | Fiberglass braid, silicone rubber coating, white 5/8" diameter, -55 °C to +200 °C NEMA TF-1 |  |  |
| <b>FFFS BLK ID 3/4-INCH-30M<sup>†</sup></b><br><b>FFFS BLK ID 3/4-INCH (10/BAG-6IN)<sup>†</sup></b> | Fiberglass braid, silicone rubber coating, black 3/4" diameter, -55 °C to +200 °C NEMA TF-1 |  |  |
| <b>FFFS BLK ID 1-INCH-30M<sup>†</sup></b><br><b>FFFS BLK ID 1-INCH (10/BAG-6IN)<sup>†</sup></b>     | Fiberglass braid, silicone rubber coating, black 1" diameter, -55 °C to +200 °C NEMA TF-1   |  |  |

<sup>†</sup> Sleeving part numbers only; cordset not included.

We reserve the right to make technical alterations without prior notice.

Silicone Tubing (\*Bulk)



| Part Number   | Specifications                                       | Application                                | Features                        |
|---|--|--|---------------------------------|
| <b>ST ID 1/4-INCH-30M<sup>†</sup></b><br><b>ST ID 1/4-INCH (10/BAG-6IN)<sup>†</sup></b> | Silicone rubber tubing, translucent 1/4" diameter UL | Protective tubing for insulation of cable. | Excellent weld slag resistance. |
| <b>ST ID 3/8-INCH-30M<sup>†</sup></b><br><b>ST ID 3/8-INCH (10/BAG-6IN)<sup>†</sup></b> | Silicone rubber tubing, translucent 3/8" diameter UL |  |                                 |
| <b>ST ID 3/8-INCH-30M<sup>†</sup></b><br><b>ST ID 3/8-INCH (10/BAG-6IN)<sup>†</sup></b> | Silicone rubber tubing, translucent 1/2" diameter UL |  |                                 |
| <b>ST ID 3/4-INCH-30M<sup>†</sup></b><br><b>ST ID 3/4-INCH (10/BAG-6IN)<sup>†</sup></b> | Silicone rubber tubing, translucent 3/4" diameter UL |  |                                 |

Add "/S1077" to end of part number to get silicone tubing assembled to pigtail or extension cordsets up to 4 meters (Picofast®, Eurofast®, Microfast® and Minifast®; 0.5 meter min. on extensions).

<sup>†</sup> Sleeving part numbers only; cordset not included.

Accessories

# Connectivity Products

## Weld Shield Sleeve - Hook and Loop Closure



| Part Number            | Specifications   | Application                                | Features  |
|------------------------|--|--|---|
| <b>FFW 1INC 2FOOT</b>  | Plain weave fiberglass, neoprene coated, black<br>1" Bundle OD, 3.25" circumference<br>4" Sleeve Width Flat, Tested to ISO 6945<br>-40 °C to +204 °C Temperature Resistance        | Applicable sleeve for protection of cable. | Sleeve offers excellent resistance to abrasion, water, most chemicals, heat, sparks, and flame in a wide operating temperature range, while being lightweight, tough and highly flexible. |
| <b>FFW 2INC 2FOOT</b>  | Plain weave fiberglass, neoprene coated, black<br>2" Bundle OD, 6" circumference<br>7.75" Sleeve Width Flat, Tested to ISO 6945<br>-40 °C to +204 °C Temperature Resistance        |  |   |
| <b>FFW 3INC 2FOOT*</b> | Plain weave fiberglass, neoprene coated, black<br>3" Bundle OD, 9.4" circumference<br>11" Sleeve Width Flat, Tested to ISO 6945<br>-40 °C to +204 °C Temperature Resistance        |  |   |
| <b>FFW 4INC 2FOOT*</b> | Plain weave fiberglass, neoprene coated, black<br>4" Bundle OD, 12.5" circumference<br>14" Sleeve Width Flat, Tested to ISO 6945<br>-40 °C to +204 °C Temperature Resistance       |  |   |
| <b>FFW 5INC 2FOOT</b>  | Plain weave fiberglass, neoprene coated, black<br>5" Bundle OD, 15.75" circumference<br>17.25" Sleeve Width Flat, Tested to ISO 6945<br>-40 °C to +204 °C Temperature Resistance   |  |   |
| <b>FFW 6INC 2FOOT</b>  | Plain weave fiberglass, neoprene coated, black<br>6" Bundle OD, 18.8" circumference<br>20.375" Sleeve Width Flat, Tested to ISO 6945<br>-40 °C to +204 °C Temperature Resistance   |  |   |
| <b>FFW 7INC 2FOOT</b>  | Plain weave fiberglass, neoprene coated, black<br>7" Bundle OD, 22" circumference<br>23.5" Sleeve Width Flat, Tested to ISO 6945<br>-40 °C to +204 °C Temperature Resistance       |  |   |
| <b>FFW 8INC 2FOOT</b>  | Plain weave fiberglass, neoprene coated, black<br>8" Bundle OD, 25.125" circumference<br>26.625" Sleeve Width Flat, Tested to ISO 6945<br>-40 °C to +204 °C Temperature Resistance |  |   |

We reserve the right to make technical alterations without prior notice.

\* 25 foot spool also available.

## Weld Seal Tape



| Part Number            | Specifications  | Application   | Features  |
|------------------------|---|---|---|
| <b>FST 1IN 12YARDS</b> | Silicone rubber, Clear 1" width,<br>12 yard length, -40 °C to +204 °C | Applicable clear tape protecting open areas between silicone tubing and mold. | Tape offers excellent resistance to water, most chemicals, heat, sparks, and flame in a wide operating temperature range, while being lightweight, and highly flexible. |

|                                      |            |
|--------------------------------------|------------|
| <b>Part Number Keys</b>              | <b>V2</b>  |
| <b>2-Branch Compact</b>              | <b>V6</b>  |
| <b>2-Branch Standard</b>             | <b>V10</b> |
| <b>M12 to M8 2-Branch</b>            | <b>V20</b> |
| <b>M12 to Valve Plug 2-Branch</b>    | <b>V22</b> |
| <b>4-Branch Standard</b>             | <b>V24</b> |
| <b>2-Branch M8 Compact</b>           | <b>V36</b> |
| <b>4-Branch M8</b>                   | <b>V44</b> |
| <b>M12 to M8 Adapters</b>            | <b>V48</b> |
| <b>M12 2-Branch Molded Splitters</b> | <b>V50</b> |

**Features**

- Multiple body styles
- M12 and M8 connectors
- 2 and 4 branch products
- LED options
- Integral connectors or cables
- Standard, parallel and series wired



# Splitters

## 2-Branch Splitter Part Number Key

Part Number Keys are to assist in IDENTIFICATION ONLY. Consult factory for catalog items not identified.

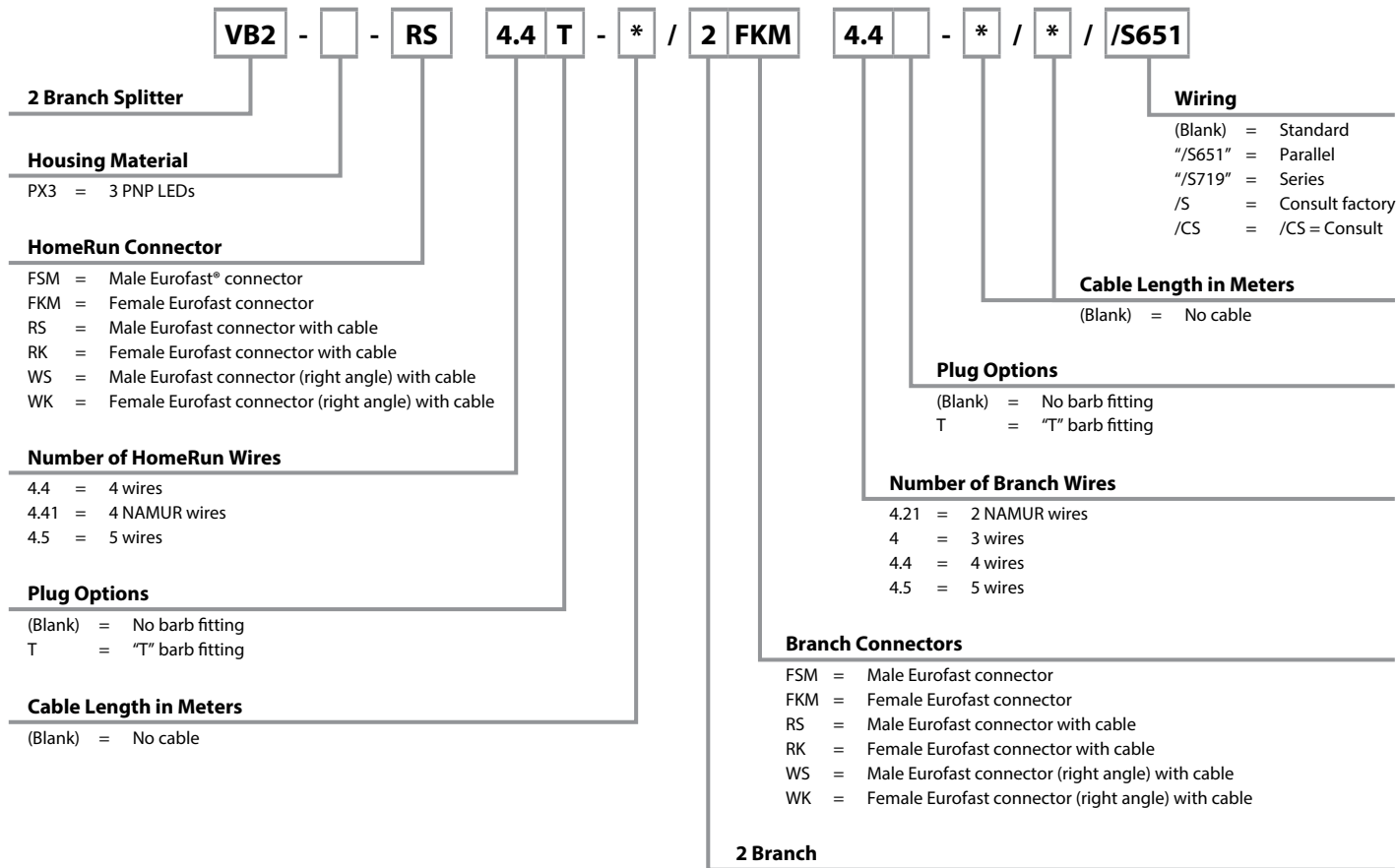

## 3 and 4 Branch Splitter Part Number Key

Part Number Keys are to assist in IDENTIFICATION ONLY. Consult factory for catalog items not identified.

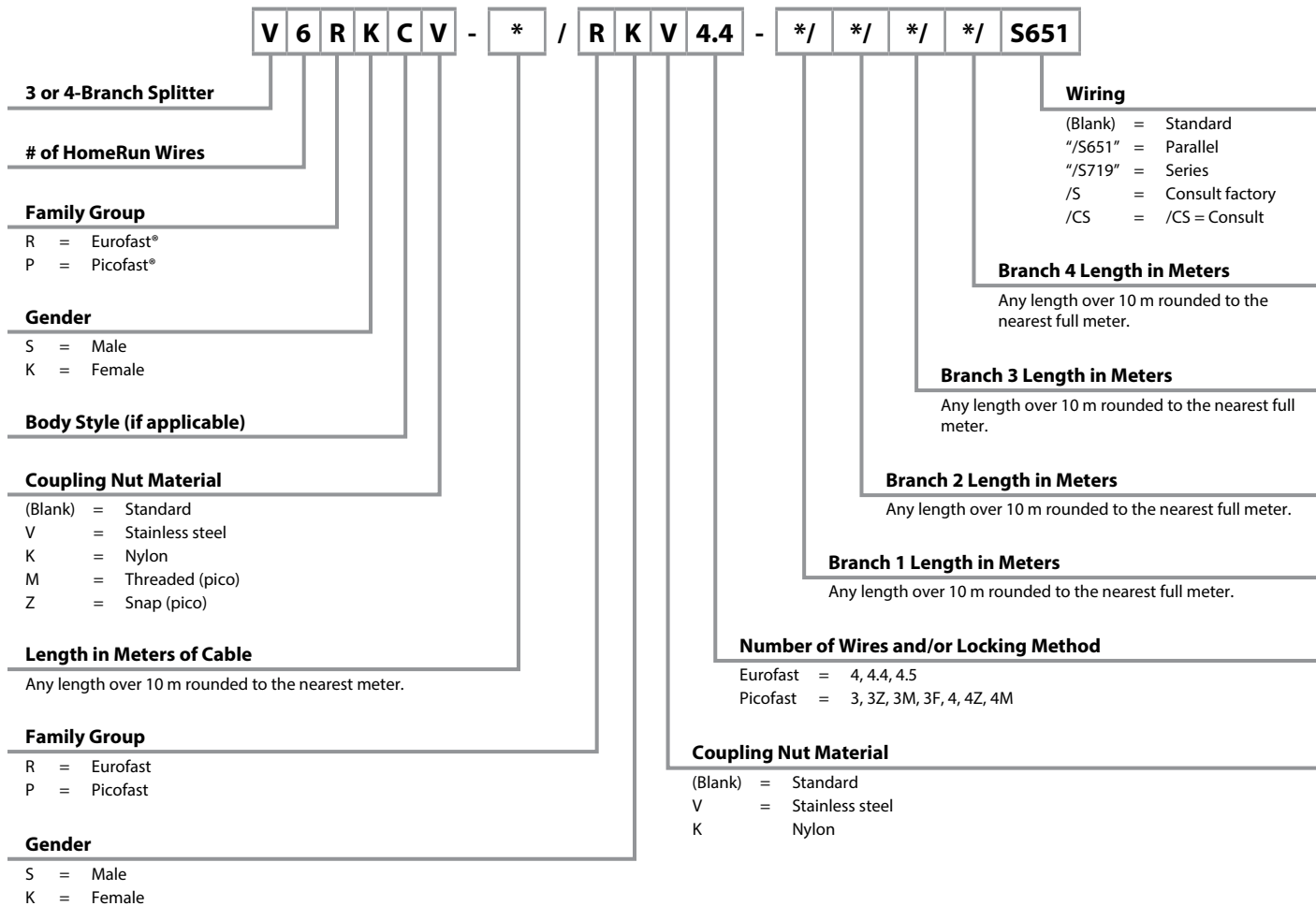

# Splitters

## 2-Branch Compact Splitter Part Number Key

Part Number Keys are to assist in IDENTIFICATION ONLY. Consult factory for catalog items not identified.

YBZ2 - [ ] - FSM 4.5 / 2 FK 4.5 - \* / \* / /S651

### Compact 2-Branch Splitter

YBZ2 = M12 Eurofast®  
 YP2 = M8 Picofast®

### Housing Material

PX3 = 3 PNP LEDs  
 PX2 = 2 PNP LEDs

### HomeRun Connector

FSM = Male Eurofast  
 PSG = Male Picofast with cable  
 RS = Male Eurofast with cable  
 MFS = Male Picofast

### Number of HomeRun Wires

4.4 = 4 wires  
 4.5 = 5 wires  
 4M = 4 wires  
 3M = 3 wires  
 6M = 6 wires

### 2 Branch

### Wiring

(Blank) = Standard  
 "/S651" = Parallel

### Cable Length in Meters

(Blank) = No cable

### Plug Options

(Blank) = No barb fitting  
 T = "T" barb fitting (M12 Eurofast)

### Number of Branch Wires

4.5 = 5 wires  
 3M = 3 wires  
 4 = 3 wires  
 4.4 = 4.4 wires  
 4M = 4 wires

### Branch Connectors

FK = Female Eurofast connector  
 PKG = Female Picofast connector with cable  
 RK = Female Eurofast connector with cable  
 MFK = Female Picofast connector  
 PSG = Male Picofast connector with cable

## 2-Branch (VBRS/K) Splitter Part Number Key

Part Number Keys are to assist in IDENTIFICATION ONLY. Consult factory for catalog items not identified.

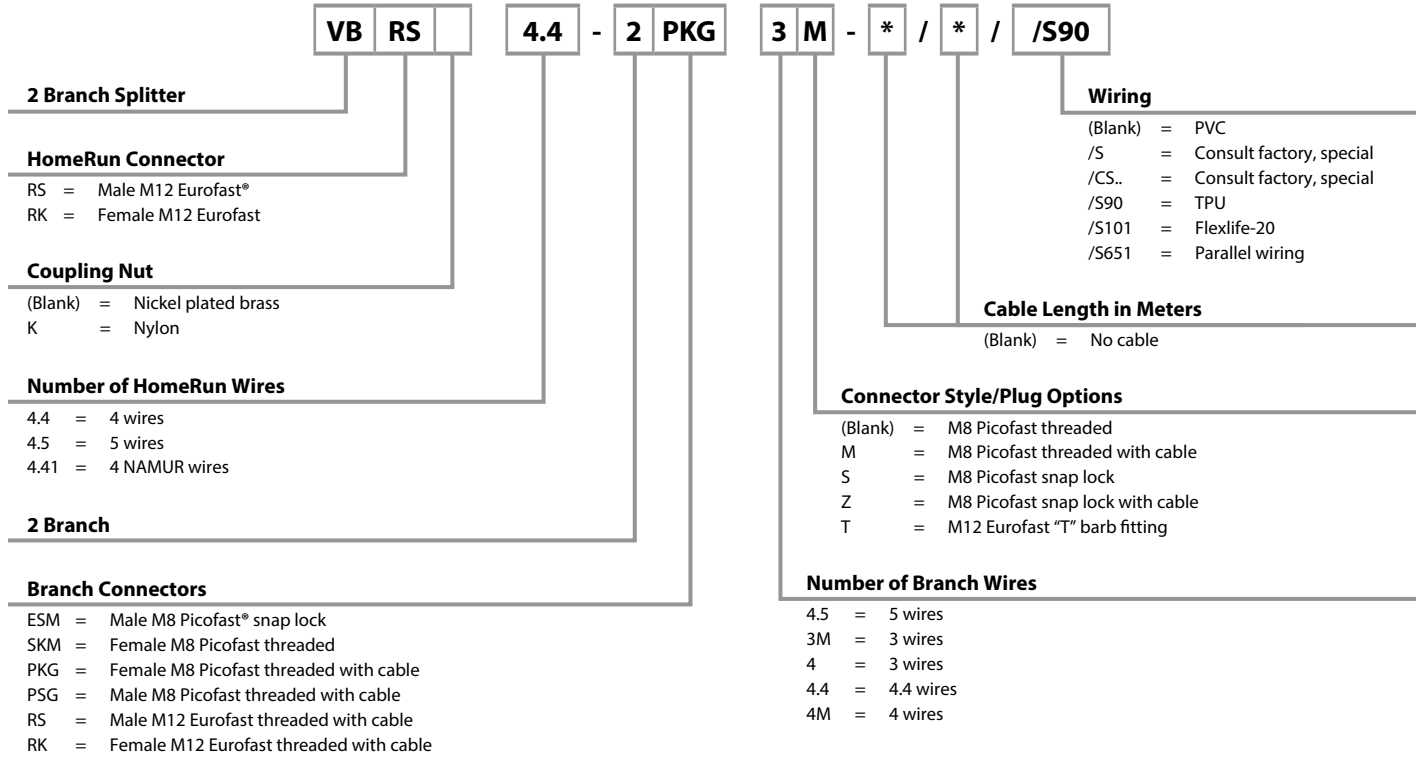

# Splitters

## M12 Eurofast® 2-Branch Compact Splitters Eurofast Trunk Connector

- Combine two Sensors into one Cable
- For use on cylinders and other Dual-Input applications
- Tough TPU Construction



| Housing | Part Number                         | Features  | Wiring Diagram  |
|---------|-------------------------------------|---|-----------------|
|         | <b>YBZ2-FSM4.4/2FK4</b>             | 250 V, 4 A, 2 Eurofast branches, 3-wire & 1 Eurofast trunk, 4-wire  | Standard        |
|         | <b>YBZ2-FSM4.4/2FK4.4/S651</b>      | 250 V, 4 A, 2 Eurofast branches, 4-wire & 1 Eurofast trunk, 4-wire  | Parallel 4-wire |
|         | <b>YBZ2-FSM4.5/2FK4.5/S651</b>      | 250 V, 4 A, 2 Eurofast branches, 5-wire & 1 Eurofast trunk, 5-wire  | Parallel 5-wire |
|         | <b>YBZ2-PX3-FSM4.4/2FK4</b>         | 10-30 VDC, 4 A, 2 Eurofast branches, 3-wire & 1 Eurofast trunk, 4-wire  | LED             |
|         | <b>YBZ2-FSM4.4/2RK4T-*/*</b>        | 250 V, 4 A, RK 4T = Grey PVC, 5.1 mm OD, 3x20 AWG, 2 Eurofast branches, 3-wire & 1 Eurofast trunk, 4-wire     | Standard        |
|         | <b>YBZ2-FSM4.4/2RK4.4T-*/*/S651</b> | 250 V, 4 A, RK 4.4T = Grey PVC, 5.1 mm OD, 4x22 AWG, 2 Eurofast branches, 4-wire & 1 Eurofast trunk, 4-wire   | Parallel 4-wire |
|         | <b>YBZ2-FSM4.4/2PKG3M-*/*</b>       | 125 V, 4 A, PKG 3M = Yellow PVC, 4.4 mm OD, 3x24 AWG, 2 Picofast® branches, 3-wire & 1 Eurofast trunk, 4-wire | Standard        |

We reserve the right to make technical alterations without prior notice.

\* Length in meters.

### Wiring Diagrams

**Standard**

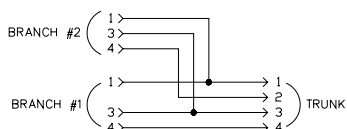

**Parallel, 4-wire**

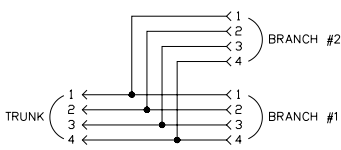

**Parallel, 5-wire**

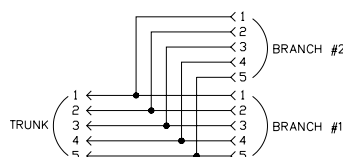

**LED**

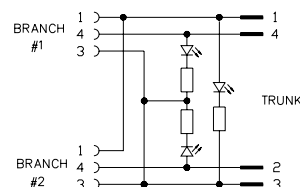



M12 Eurofast® 2-Branch Compact Splitters Eurofast Trunk Connector

Specifications

|                       |   |                       |                                       |
|-----------------------|---|-----------------------|---------------------------------------|
| <b>Junction Body:</b> | Oil resistant yellow TPU                                      | <b>Coupling Nuts:</b> | Nickel plated brass                   |
| <b>Connector:</b>     | Oil resistant TPU body material, Nylon or TPU contact carrier | <b>Cable:</b>         | See table                             |
| <b>Contacts:</b>      | Gold plated brass   | <b>Temperature:</b>   | -40 °C to +105 °C (-40 °F to +221 °F) |
|                       |   | <b>Protection:</b>    | NEMA 1, 3, 4, 6P and IEC IP68         |

**Cable Length:** Branches - nominal 0.3 meters. Other lengths available by request - consult factory.  
**Cable Options:** Standard cable jacket - grey/yellow PVC. TPU and other jackets available by request - consult factory.  
**Connector Options:** (for legs with cable) Stainless steel coupling nut add "V" to part number (PKG to PKGV, PSG to PSGV, RK to RKV).  
**Notes:** Mounting hole accepts #4 screw.

We reserve the right to make technical alterations without prior notice.

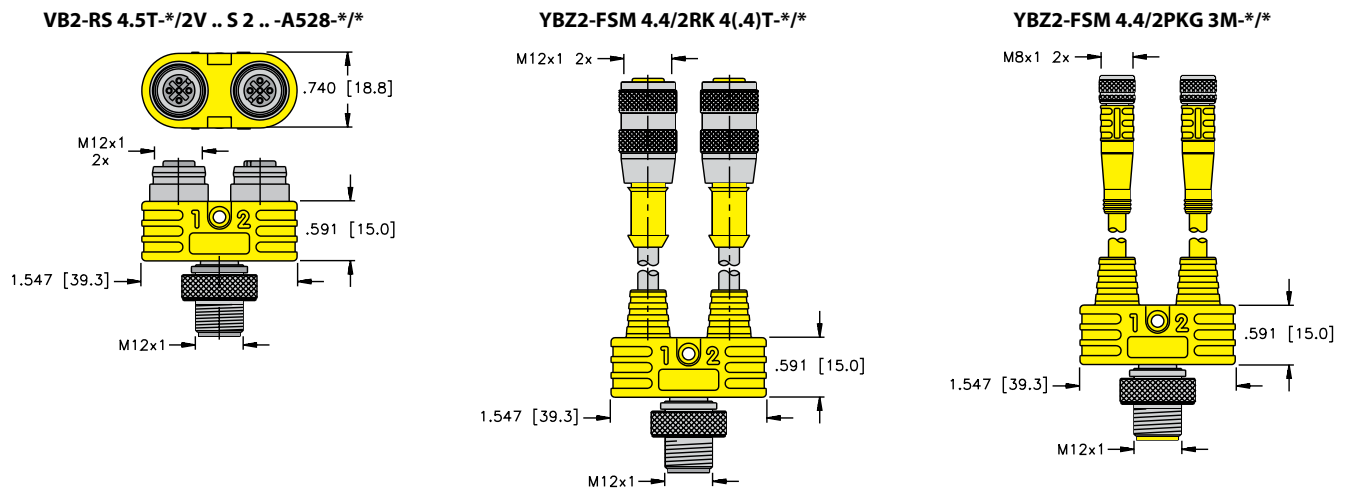

Pinouts

| 4-Pin Eurofast | 5-Pin Eurofast | 3-Pin Picofast® | 4-Pin Eurofast | 5-Pin Eurofast |
|----------------|----------------|-----------------|----------------|----------------|
| Female         |                |                 | Male           |                |
|                |                |                 |                |                |

# Splitters

## M12 Eurofast® 2-Branch Compact Splitters, Trunk and Branch Extensions

- Combine two sensors into one Cable
- For use on Cylinders and other Dual-Input applications
- Tough TPU Construction



| Housing | Part Number                           | Features  | Wiring Diagram  |
|---------|---------------------------------------|---|-----------------|
|         | <b>YBZ2-RS4.4T-*/2RK4T-*/*</b>        | 250 V, 4 A, RS 4.4T = Grey PVC, 5.1 mm OD, 4x22 AWG, RK 4T = Grey PVC, 5.1 mm OD, 3x20 AWG, 2 Eurofast branches, 3-wire & 1 Eurofast trunk, 4-wire      | Standard        |
|         | <b>YBZ2-RS4.4T-*/2RK4.4T-*/*/S651</b> | 250 V, 4 A, RS 4.4T & RK 4.4T = Grey PVC, 5.1 mm OD, 4x22 AWG, 2 Eurofast branches, 4-wire & 1 Eurofast trunk, 4-wire                                   | Parallel 4-wire |
|         | <b>YBZ2-RS4.5T-*/2RK4.5T-*/*/S651</b> | 250 V, 4 A, RK 4.5T & RS 4.5T = Grey PVC, 5.7 mm OD, 5x22 AWG, 2 Eurofast branches, 5-wire & 1 Eurofast trunk, 5-wire                                   | Parallel 5-wire |
|         | <b>YBZ2-PSG4M-*/2PKG3M-*/*</b>        | 125 V, 2 A, PSG 4M = Yellow PVC, 4.4 mm OD, 4x26 AWG, PKG 3M = Yellow PVC, 4.4 mm OD, 3x24 AWG, 2 Picofast® branches, 3-wire & 1 Picofast trunk, 4-wire | Standard        |
|         | <b>YBZ2-PSG3M-*/2PKG3M-*/*/S651</b>   | 125 V, 4 A, PSG 3M & PKG 3M = Yellow PVC, 4.4 mm OD, 3x24 AWG, 2 Picofast branches, 3-wire & 1 Picofast trunk, 3-wire                                   | Parallel 3-wire |
|         | <b>YBZ2-RS4.5T-*/2VAS22-A653-*/*</b>  | 220 V, 4 A, RS 4.5T = Grey PVC, 5.1 mm OD, 4x22 AWG, VAS22 = Grey PVC, 6.2 mm OD, 3x18 AWG, 2 valve branches, 3-wire & 1 Eurofast trunk, 4-wire         | Standard valve  |

\* Length in meters.

We reserve the right to make technical alterations without prior notice.

### Wiring Diagrams

**Standard**

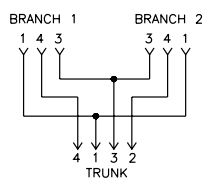

**Parallel, 3-wire**

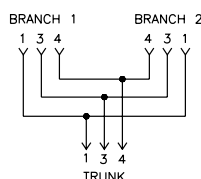

**Standard, valve**

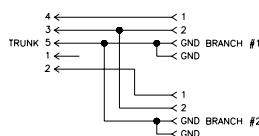

**Parallel, 4-wire**

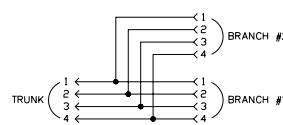

**Parallel, 5-wire**

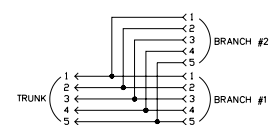

M12 Eurofast® 2-Branch Compact Splitters, Trunk and Branch Extensions

Specifications

|                       |   |                       |                                       |
|-----------------------|---|-----------------------|---------------------------------------|
| <b>Junction Body:</b> | Oil resistant yellow TPU                                      | <b>Coupling Nuts:</b> | Nickel plated brass                   |
| <b>Connector:</b>     | Oil resistant TPU body material, Nylon or TPU contact carrier | <b>Cable:</b>         | See table                             |
| <b>Contacts:</b>      | Gold plated brass   | <b>Temperature:</b>   | -40 °C to +105 °C (-40 °F to +221 °F) |
|                       |   | <b>Protection:</b>    | NEMA 1, 3, 4, 6P and IEC IP68         |

- Cable Length:** Branches - nominal 0.3 meters. Other lengths available by request - consult factory.
- Cable Options:** Standard cable jacket - grey/yellow PVC. TPU and other jackets available by request - consult factory.
- Connector Options:** (for legs with cable)  
Stainless steel coupling nut add "V" to part number (PKG to PKGV, PSG to PSGV, RK to RKV).
- Notes:** Mounting hole accepts #4 screw.

We reserve the right to make technical alterations without prior notice.

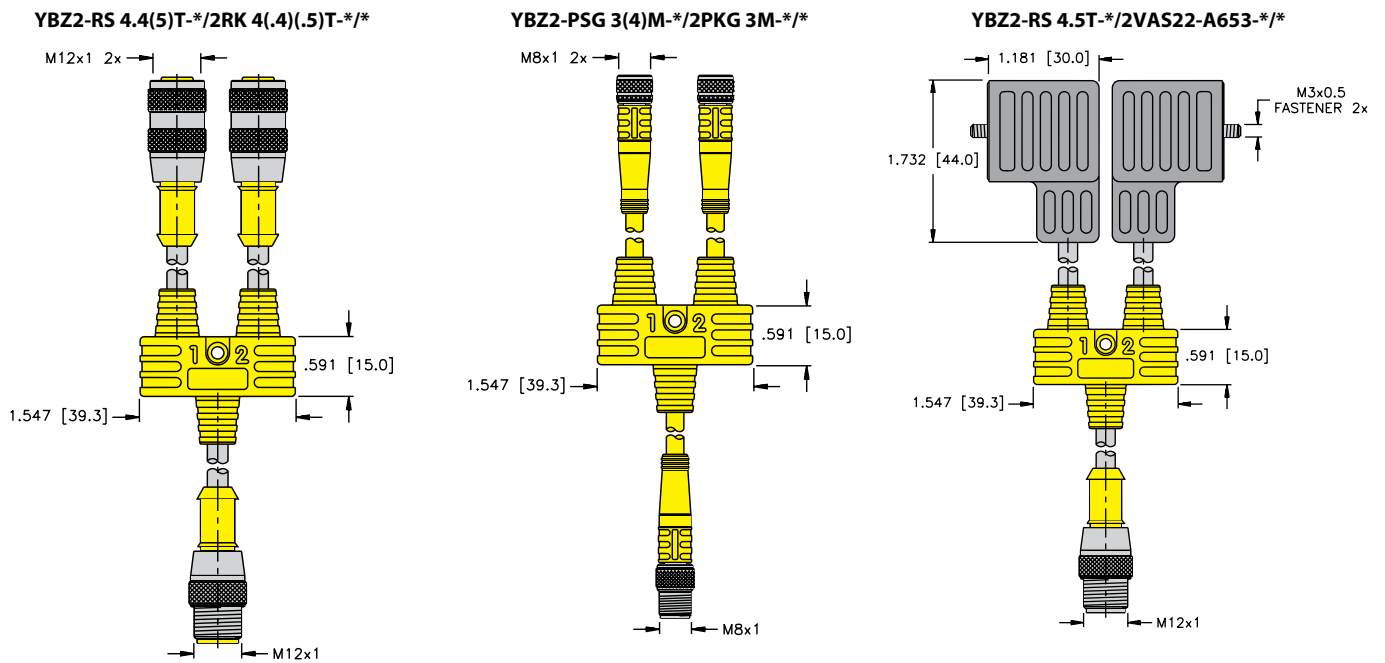

Pinouts

| 4-Pin Eurofast | 5-Pin Eurofast | 3-Pin Picofast® | 3-Pin Picofast | 4-Pin Picofast | 5-Pin Eurofast |
|----------------|----------------|-----------------|----------------|----------------|----------------|
| Female         |                |                 | Male           |                |                |
|                |                |                 |                |                |                |

# Splitters

## Eurofast® 2-Branch Splitters, Standard and LED Wiring

- Combine two Sensors into one Cable
- For use on Cylinders and other Dual-Input applications
- Tough TPU Construction
- For 3-wire DC Sensors or Switches



| Housing | Part Number                        | Features   | Wiring Diagram |
|---------|------------------------------------|--|----------------|
|         | <b>VB2-FSM 4.4/2FKM 4</b>          | 250 V, 4.0 A, combine two sensors into one cable   | Standard       |
|         | <b>VB2-RS 4.4T-*/2FKM 4</b>        | 250 V, 4.0 A, RS 4.4T = Grey PVC, 5.1 mm OD, 4x22 AWG, combine two sensors into one cable  |                |
|         | <b>VB2-FSM 4.4/2RK 4T-*/**</b>     | 250 V, 4.0 A, Grey PVC, 5.1 mm OD, RK 4T - 3x20 AWG, combine two sensors into one cable  |                |
|         | <b>VB2-RS 4.4T-*/2RK 4T-*/**</b>   | 250 V, 4.0 A, Grey PVC, 5.1 mm OD, RK 4T - 3x20 AWG, RS 4.4T - 4x22 AWG, combine two sensors into one cable                                      |                |
|         | <b>VB2P3-FSM 4.4/2FKM 4</b>        | 10-30 VDC, 4.0 A, combine two sensors into one cable; 3 LEDs, 2 signals, PNP, 1 power  | LED            |
|         | <b>VB2P3-RS 4.4T-*/2FKM 4</b>      | 10-30 VDC, 4.0 A, RS 4.4T = Grey PVC, 5.1 mm OD, 4x22 AWG, combine two sensors into one cable; 3 LEDs, 2 signals, PNP, 1 power                   |                |
|         | <b>VB2P3-FSM 4.4/2RK 4T-*/**</b>   | 10-30 VDC, 4.0 A, Grey PVC, 5.1 mm OD, RK 4T - 3x20 AWG, combine two sensors into one cable; 3 LEDs, 2 signals, PNP, 1 power                     |                |
|         | <b>VB2P3-RS 4.4T-*/2RK 4T-*/**</b> | 10-30 VDC, 4.0 A, Grey PVC, 5.1 mm OD, RK 4T - 3x20 AWG, RS 4.4T - 4x22 AWG, combine two sensors into one cable; 3 LEDs, 2 signals, PNP, 1 power |                |

We reserve the right to make technical alterations without prior notice.

### Wiring Diagrams

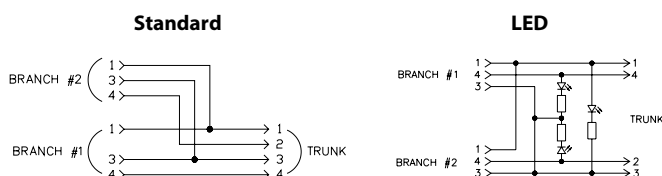

Eurofast® 2-Branch Splitters, Standard and LED Wiring

Specifications

**Junction Body:** Oil resistant yellow TPU (non-LED)  
Translucent black TPU (LED)

**Coupling Nuts:** Nickel plated brass

**Connector:** Oil resistant TPU body material, Nylon or TPU contact carrier

**Cable:** See table

**Contacts:** Gold plated brass

**Temperature:** -40 °C to +105 °C (-40 °F to +221 °F)

**Protection:** IEC IP67

**Cable Length:** Trunk - nominal 1 meter. Branches - nominal 0.3 meters. Other lengths available by request - consult factory.

**Cable Options:** Standard cable jacket - grey PVC. TPU and other jackets available by request - consult factory.

**Connector Options:** (for legs with cable)  
Stainless steel coupling nut add "V" to part number (RS to RSV, RK to RKV).  
Nylon coupling nut add "K" to part number (RS to RSK, RK to RKK).  
Right angle connectors, change part number (RS to WS, RK to WK).

**Notes:** Mounting hole accepts #8 screw.

VB2-RS 4.4T-\*/2RK 4T-\*/\*  
VB2-PX3-RS 4.4T/2RK 4T-\*/\*

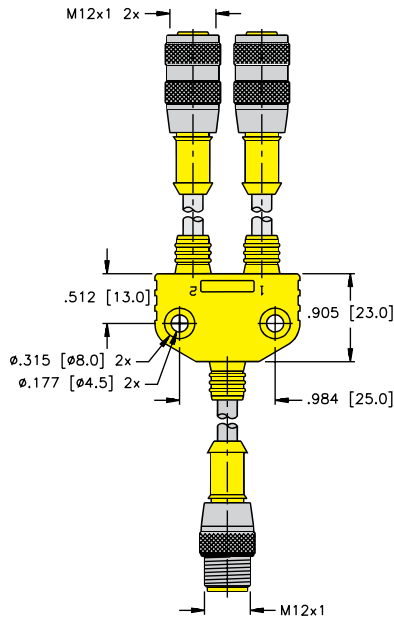

VB2-RS 4.4T-\*/2FKM 4  
VB2-PX3-RS 4.4T-\*/2FKM 4

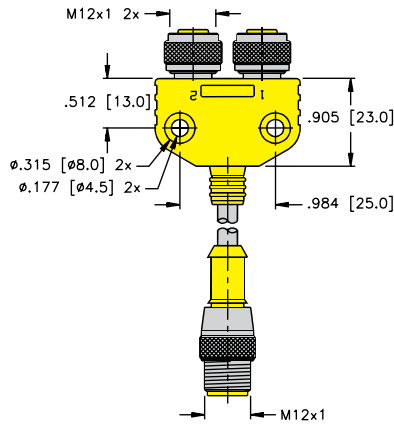

VB2-FSM 4.4/2RK 4T-\*/\*  
VB2-PX3-FSM 4.4/2RK 4T-\*/\*

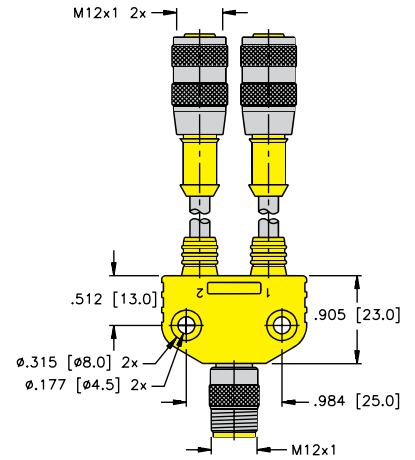

VB2-FSM 4.4/2FKM 4  
VB2-PX3-FSM 4.4/2FKM 4

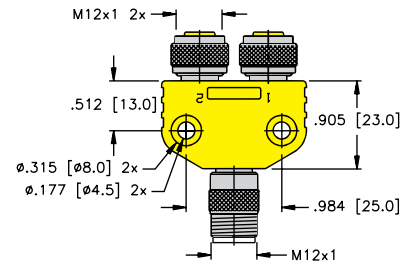

We reserve the right to make technical alterations without prior notice.

Pinouts

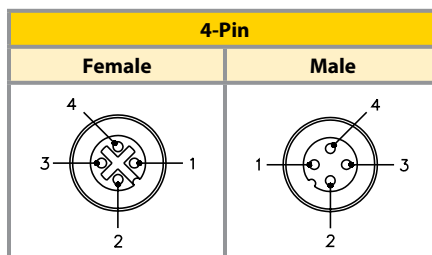

# Splitters

## M12 Eurofast® 2-Branch Splitters, Parallel Wiring, Shielded Option

- For use on Photoelectric Controls, Power Distribution, and other Dual-Input applications
- Tough TPU Construction



| Housing | Part Number                          | Features   | Wiring Diagram     |
|---------|--------------------------------------|--|--------------------|
|         | <b>VB2-FSM 4.4/2FKM 4.4/S651</b>     | 250 V, 4.0 A, parallel wired, 4 conductor  | Parallel           |
|         | <b>VB2-RS 4.4T-*/2FKM 4.4/S651</b>   | 250 V, 4.0 A, RS 4.4T = Grey PVC, 5.1 mm OD, 4x22 AWG, parallel wired, 4 conductor | Parallel           |
|         | <b>VB2-FSM 4.4/2RK 4.4T-*/S651</b>   | 250 V, 4.0 A, RK 4.4T = Grey PVC, 5.1 mm OD, 4x22 AWG, parallel wired, 4 conductor | Parallel           |
|         | <b>VB2-RS 4.4T-*/2RK 4.4T-*/S651</b> | 250 V, 4.0 A, Grey PVC, 5.1 mm OD, 4x22 AWG, parallel wired, 4 conductor           | Parallel           |
|         | <b>VB2-FSM 4.5/2FKM 4.5/S651</b>     | 250 V, 4.0 A, parallel wired, 5 conductor  | Parallel           |
|         | <b>VB2-FSMS 4.5/2FKMS 4.5/S651</b>   | 250 V, 4.0 A, parallel wired, Shielded, 5 conductor                                | Parallel, Shielded |
|         | <b>VB2-RS 4.5T-*/2FKM 4.5/S651</b>   | 250 V, 4.0 A, RS 4.5T = Grey PVC, 5.7 mm OD, 5x22 AWG, parallel wired, 5 conductor | Parallel           |
|         | <b>VB2-FSM 4.5/2RK 4.5T-*/S651</b>   | 250 V, 4.0 A, RK 4.5T = Grey PVC, 5.7 mm OD, 5x22 AWG, parallel wired, 5 conductor | Parallel           |
|         | <b>VB2-RS 4.5T-*/2RK 4.5T-*/S651</b> | 250 V, 4.0 A, Grey PVC, 5.7 mm OD, 5x22 AWG, parallel wired, 5 conductor           | Parallel           |
|         | <b>VB2-FKMS 4.5/2FSMS 4.5/S651</b>   | 250 V, 4.0 A, parallel wired, shielded, 5 conductor                                | Parallel, Shielded |

We reserve the right to make technical alterations without prior notice.

### Wiring Diagrams

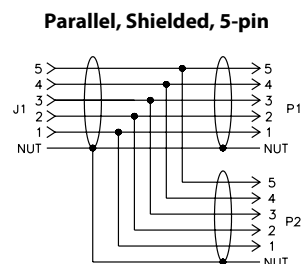
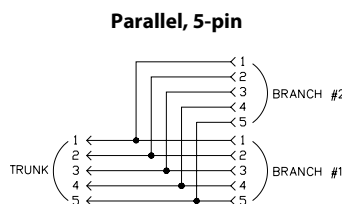
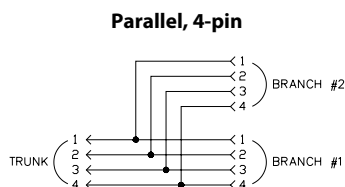

M12 Eurofast® 2-Branch Splitters, Parallel Wiring, Shielded Option

Specifications

|                       |   |                       |                                       |
|-----------------------|---|-----------------------|---------------------------------------|
| <b>Junction Body:</b> | Oil resistant yellow TPU                                      | <b>Coupling Nuts:</b> | Nickel plated brass                   |
| <b>Connector:</b>     | Oil resistant TPU body material, Nylon or TPU contact carrier | <b>Cable:</b>         | See table                             |
| <b>Contacts:</b>      | Gold plated brass   | <b>Temperature:</b>   | -40 °C to +105 °C (-40 °F to +221 °F) |
|                       |   | <b>Protection:</b>    | IEC IP67, IEC IP60 (shielded)         |

**Cable Length:** Trunk - nominal 1 meter. Branches - nominal 0.3 meters. Other lengths available by request - consult factory.

**Cable Options:** Standard cable jacket - grey PVC. TPU and other jackets available by request - consult factory.

**Connector Options:** (for legs with cable)

Stainless steel coupling nut add "V" to part number (RS to RSV, RK to RKV).

Nylon coupling nut add "K" to part number (RS to RSK, RK to RKK).

Right angle connectors, change part number (RS to WS, RK to WK).

**Notes:** Mounting holes accept #8 screw.

We reserve the right to make technical alterations without prior notice.

VB2-RS 4.4(5)T-\*/2RK 4.4(5)T-\*/S651

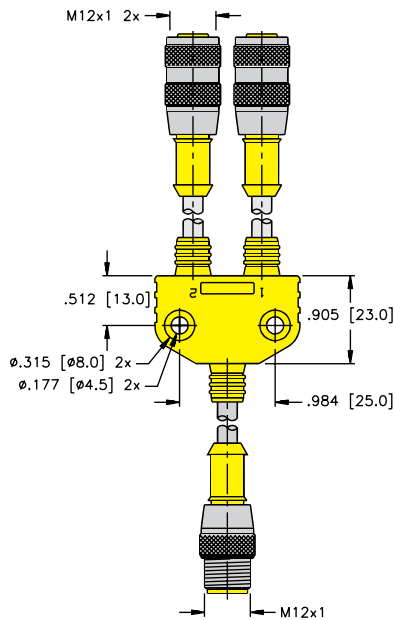

VB2-FSM 4.4(5)/2RK 4.4(5)T-\*/S651

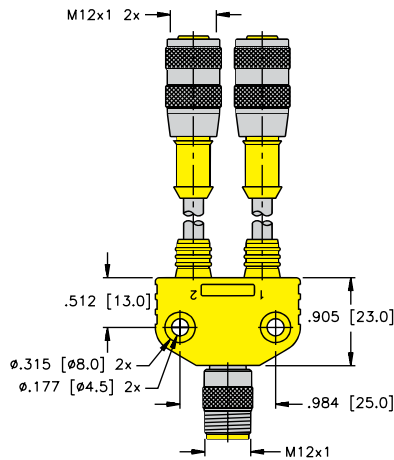

VB2-RS 4.4(5)T-\*/2FKM 4.4(5)/S651

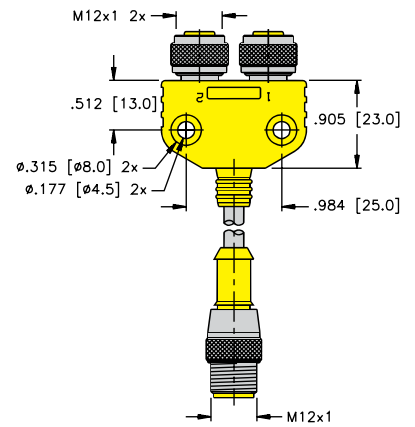

VB2-FSM(S) 4.4(5)/2FKM(S) 4.4(5)/S651

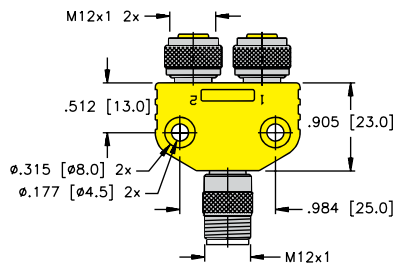

VB2-FKMS 4.5/2FSMS 4.5/S651

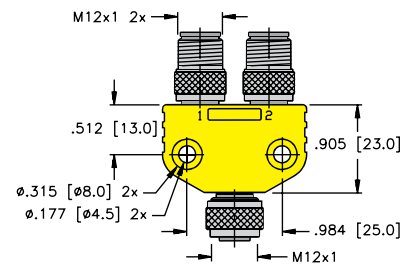

Pinout

| 4-Pin  | 5-Pin | 4-Pin | 5-Pin |
|--------|-------|-------|-------|
| Female |       | Male  |       |
|        |       |       |       |

# Splitters

## M12 Eurofast® 2-Branch Splitters, Series Wiring

- Combine two Sensors into one Cable
- Series Wired
- Tough TPU Construction
- For 3-wire DC Sensors or Switches



| Housing | Part Number                          | Features   | Wiring Diagram |
|---------|--------------------------------------|--|----------------|
|         | <b>VB2-FSM 4.4/2FKM 4/S719</b>       | 250 V, 4.0 A, series wired for AND function (PNP signals)  | Series         |
|         | <b>VB2-RS 4.4T-*/2FKM 4/S719</b>     | 250 V, 4.0 A, RS 4.4T = Grey PVC, 5.1 mm OD, 4x22 AWG, series wired for AND function (PNP signals)                   |                |
|         | <b>VB2-FSM 4.4/2RK 4T-*/*/S719</b>   | 250 V, 4.0 A, RK 4T = Grey PVC, 5.1 mm OD, 3x20 AWG, series wired for AND function (PNP signals)                     |                |
|         | <b>VB2-RS 4.4T-*/2RK 4T-*/*/S719</b> | 250 V, 4.0 A, Grey PVC, 5.1 mm OD, RK 4T - 3x20 AWG, RS 4.4T - 4x22 AWG, series wired for AND function (PNP signals) |                |

\* Length in meters.

We reserve the right to make technical alterations without prior notice.

### Wiring Diagrams

#### Series

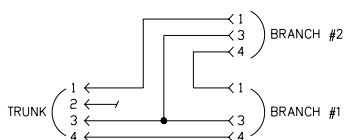



M12 Eurofast® 2-Branch Splitters, Series Wiring

Specifications

|                       |   |                       |                                       |
|-----------------------|---|-----------------------|---------------------------------------|
| <b>Junction Body:</b> | Oil resistant yellow TPU                                      | <b>Coupling Nuts:</b> | Nickel plated brass                   |
| <b>Connector:</b>     | Oil resistant TPU body material, Nylon or TPU contact carrier | <b>Cable:</b>         | See table                             |
| <b>Contacts:</b>      | Gold plated brass   | <b>Temperature:</b>   | -40 °C to +105 °C (-40 °F to +221 °F) |
|                       |   | <b>Protection:</b>    | IEC IP67                              |

**Cable Length:** Trunk - nominal 1 meter. Branches - nominal 0.3 meters. Other lengths available by request - consult factory.

**Cable Options:** Standard cable jacket - grey PVC. TPU and other jackets available by request - consult factory.

**Connector Options:** (for legs with cable)

Stainless steel coupling nut add "V" to part number (RS to RSV, RK to RKV).

Nylon coupling nut add "K" to part number (RS to RSK, RK to RKK).

Right angle connectors, change part number (RS to WS, RK to WK).

**Notes:** Mounting holes accept #8 screw.

VB2-RS 4.4T-\*/2RK 4T-\*/S719

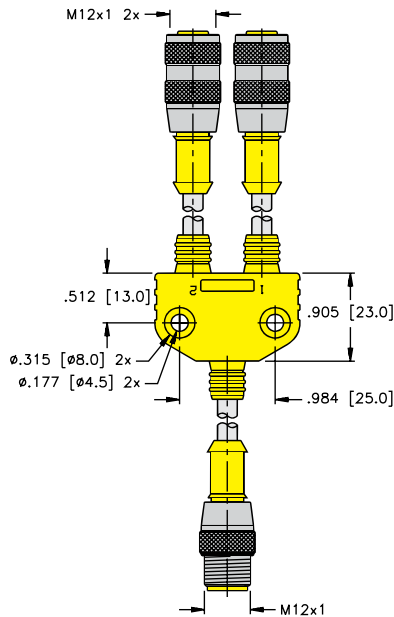

VB2-FSM 4.4/2RK 4T-\*/S719

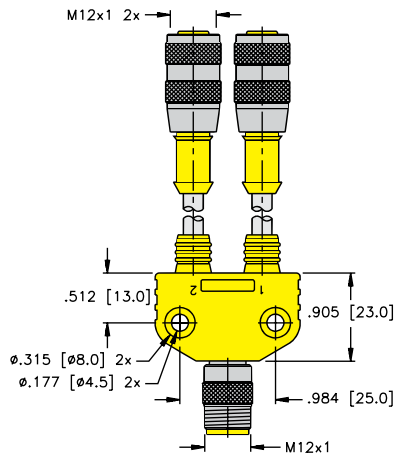

VB2-RS 4.4T-\*/2FKM 4/S719

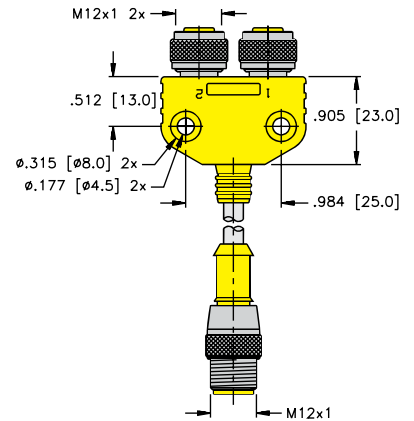

VB2-FSM 4.4/2FKM 4/S719

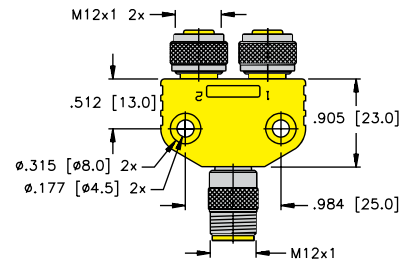

We reserve the right to make technical alterations without prior notice.

Pinouts

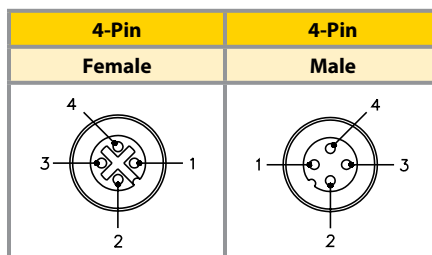

# Splitters

## M12 Eurofast® 2-Branch Splitters, NAMUR Wiring

- Combine two NAMUR Sensors into one Cable
- Tough TPU Construction
- For use with NAMUR Junction Boxes



| Housing | Part Number                        | Features  | Wiring Diagram |
|---------|------------------------------------|---|----------------|
|         | <b>VB2-FSM 4.41/2FKM 4.21</b>      | 250 V, 4.0 A, combine two NAMUR sensors into one cable  | NAMUR          |
|         | <b>VB2-RS 4.41T-*/2FKM 4.21</b>    | 250 V, 4.0 A, RS 4.41T = Blue PVC, 5.1 mm OD, 4x22 AWG, combine two NAMUR sensors into one cable                      |                |
|         | <b>VB2-FSM 4.41/2RK 4.21T-*/</b>   | 250 V, 4.0 A, RK 4.21T = Blue PVC, 5.1 mm OD, 2x20 AWG, combine two NAMUR sensors into one cable                      |                |
|         | <b>VB2-RS 4.41T-*/2RK 4.21T-*/</b> | 250 V, 4.0 A, Blue PVC, 5.1 mm OD, RK 4.21T – 2x20 AWG, RS 4.41T – 4x22 AWG, combine two NAMUR sensors into one cable |                |

\* Length in meters.

We reserve the right to make technical alterations without prior notice.

### Namur Wiring Diagram

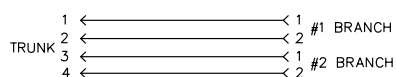

M12 Eurofast® 2-Branch Splitters, NAMUR Wiring

Specifications

|                       |   |                       |                                       |
|-----------------------|---|-----------------------|---------------------------------------|
| <b>Junction Body:</b> | Oil resistant yellow TPU                                      | <b>Coupling Nuts:</b> | Nickel plated brass                   |
| <b>Connector:</b>     | Oil resistant TPU body material, Nylon or TPU contact carrier | <b>Cable:</b>         | See table                             |
| <b>Contacts:</b>      | Gold plated brass   | <b>Temperature:</b>   | -40 °C to +105 °C (-40 °F to +221 °F) |
|                       |   | <b>Protection:</b>    | IEC IP67                              |

**Cable Length:** Trunk - nominal 1 meter. Branches - nominal 0.3 meters. Other lengths available by request - consult factory.

**Connector Options:** (for legs with cable)  
 Stainless steel coupling nut add "V" to part number (RS to RSV, RK to RKV).  
 Nylon coupling nut add "K" to part number (RS to RSK, RK to RKK).  
 Right angle connectors, change part number (RS to WS, RK to WK).

**Notes:** Mounting holes accept #8 screw.

We reserve the right to make technical alterations without prior notice.

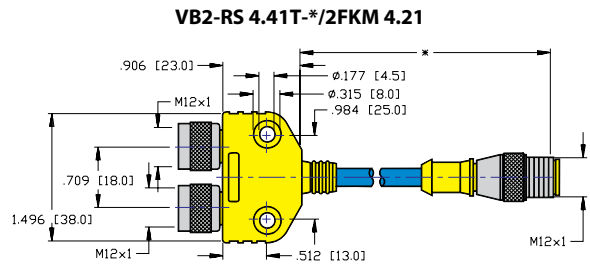
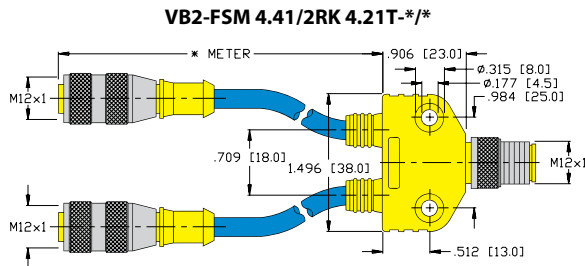
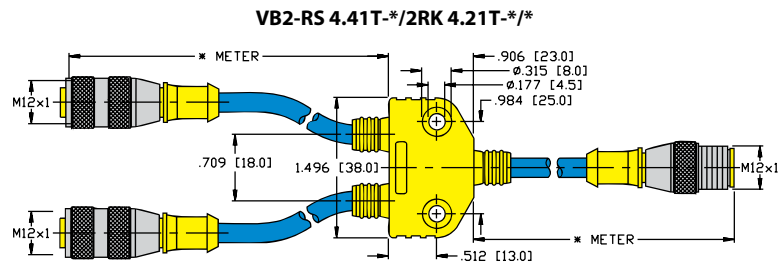
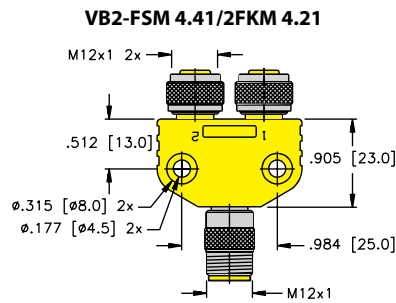

Pinouts

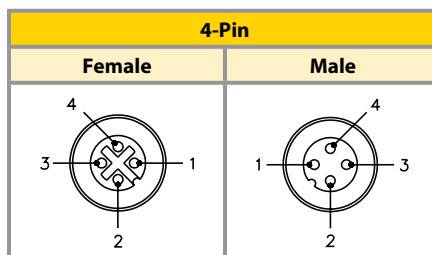

# Splitters

## M12 Eurofast® 2-Branch Splitters, NAMUR Wiring

- Combine two NAMUR Sensors into one Cable
- Eurofast Connection features Anti-Vibration Coupling Nut (main leg only)
- Tough TPU Body resists Oil and Abrasion
- Compact size saves space



| Housing | Part Number              | Features   | Wiring Diagram |
|---------|--------------------------|--|----------------|
|         | VBRS 4.41-2RK 4.21T-*/** | 250 V, 4.0 A, 2x20 AWG, Blue PVC, 5.1 mm OD, combine two NAMUR sensors into one cable. Connects directly to Eurofast junction box. | NAMUR          |

\* Length in meters.  
To add mounting hole, add /S857 to the end of the part number.

We reserve the right to make technical alterations without prior notice.

### Namur Wiring Diagram

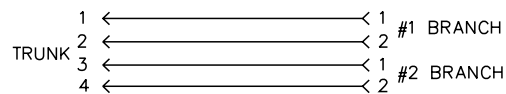

## M12 Eurofast® 2-Branch Splitters, NAMUR Wiring

### Specifications

|                       |   |                     |                                       |
|-----------------------|---|---------------------|---------------------------------------|
| <b>Junction Body:</b> | Oil resistant yellow TPU                                      | <b>Cable:</b>       | See table                             |
| <b>Connector:</b>     | Oil resistant TPU body material, Nylon or TPU contact carrier | <b>Temperature:</b> | -40 °C to +105 °C (-40 °F to +221 °F) |
| <b>Contacts:</b>      | Gold plated brass, machined from solid stock                  | <b>Protection:</b>  | NEMA 1, 3, 4, 6P and IEC IP67         |
| <b>Coupling Nuts:</b> | Nickel plated brass   | <b>Accessories:</b> | KS 5/10 labels 2 of each included     |

**Cable Length:** Branches - nominal 0.3 meters. Other lengths available by request - consult factory.

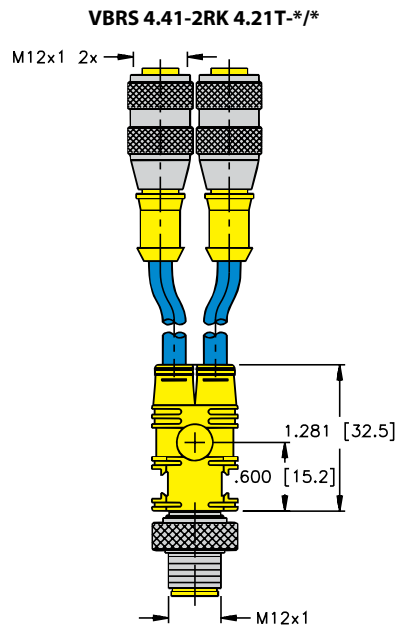

We reserve the right to make technical alterations without prior notice.

### Pinouts

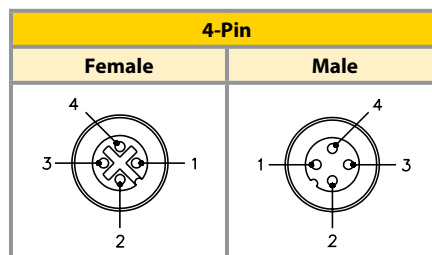

# Splitters

## M12 Eurofast® and M8 Picofast® 2-Branch Molded Splitters

- Combine two Picofast or Eurofast Connections into one Eurofast Receptacle
- Eurofast Connection features Anti-vibration Coupling Nut (main leg only)
- Compact size saves space
- Tough TPU Body resists Oil and Abrasion



| Housing | Part Number                  | Features   | Wiring Diagram |
|---------|------------------------------|--|----------------|
|         | <b>VBRK 4.4-2ESM 3S</b>      | 60 VAC/75 VDC, 4.0 A, for sensors with complementary outputs, splits signals. Branches have snap lock  | Diagram A      |
|         | <b>VBRS 4.4-2SKM 3</b>       | 60 VAC/75 VDC, 4.0 A, combine two sensors into one cable. Connects directly to Eurofast junction box. Branches have threaded coupling nut                                  | Diagram B      |
|         | <b>VBRS 4.4-2PKG 3M-*/**</b> | 60 VAC/75 VDC, 4.0 A, 3x24 AWG, Yellow PVC, 4.4 mm OD, combine two sensors into one cable. Connects directly to Eurofast junction box. Branches have threaded coupling nut | Diagram B      |
|         | <b>VBRS 4.4-2PKG 3Z-*/**</b> | 60 VAC/75 VDC, 4.0 A, 3x24 AWG, Yellow PVC, 4.4 mm OD, combine two sensors into one cable. Connects directly to Eurofast junction box. Branches have snap lock             | Diagram B      |
|         | <b>VBRS 4.4-2RK 4T-*/**</b>  | 250 V, 4.0 A, 3x20 AWG, Grey PVC, 5.1 mm OD, combine two sensors into one cable. Connects directly to Eurofast junction box  | Diagram B      |

\* Length in meters.  
To add mounting hole, add /S857 to the end of the part number.

We reserve the right to make technical alterations without prior notice.

### Wiring Diagrams

Diagram A

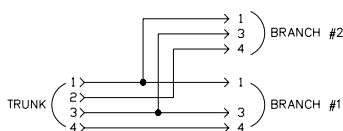
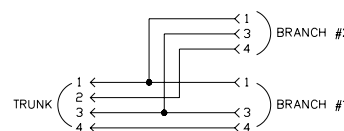

Diagram B



M12 Eurofast® and M8 Picofast® 2-Branch Molded Splitters

Specifications

|                       |   |                     |                                       |
|-----------------------|---|---------------------|---------------------------------------|
| <b>Junction Body:</b> | Oil resistant yellow TPU                                      | <b>Cable:</b>       | See table                             |
| <b>Connector:</b>     | Oil resistant TPU body material, Nylon or TPU contact carrier | <b>Temperature:</b> | -40 °C to +105 °C (-40 °F to +221 °F) |
| <b>Contacts:</b>      | Gold plated brass   | <b>Protection:</b>  | NEMA 1, 3, 4, 6P and IEC IP67         |
| <b>Coupling Nuts:</b> | Nickel plated brass. POM locking sleeve                       | <b>Accessories:</b> | KS 5/10 labels included               |

**Cable Length:** Branches - nominal 0.3 meters. Other lengths available by request - consult factory.

We reserve the right to make technical alterations without prior notice.

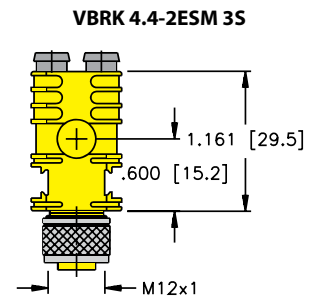
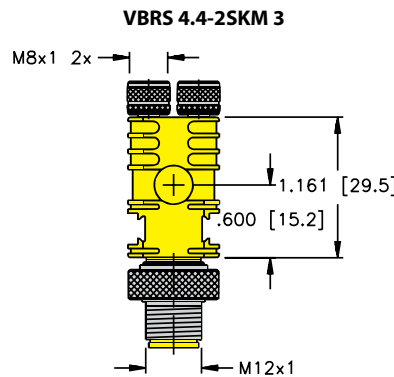
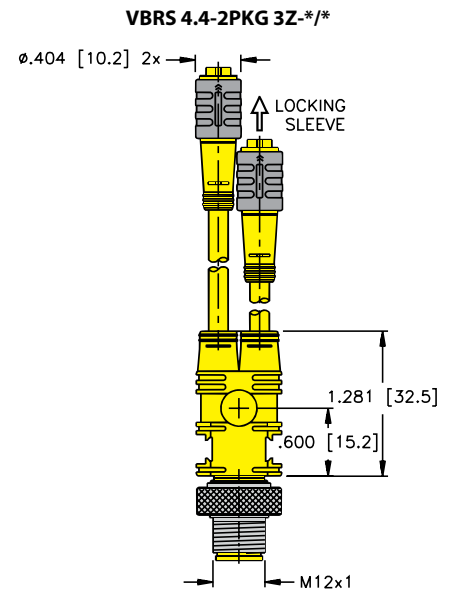
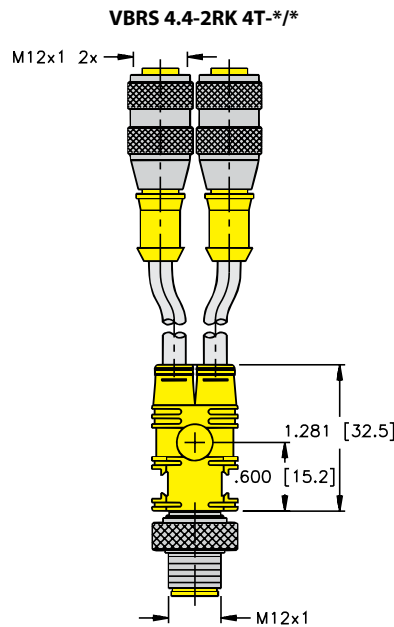
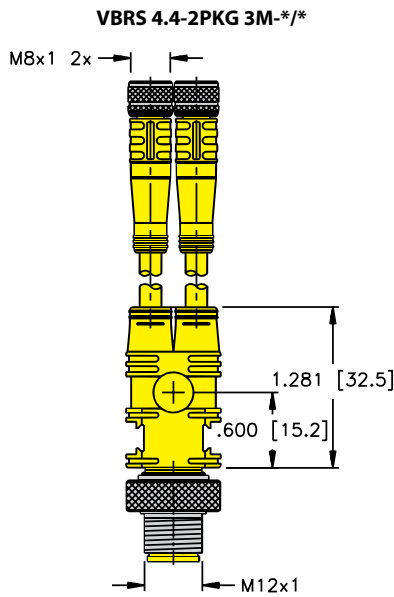

Pinout

| 3-Pin Picofast | 4-Pin Eurofast | 3-Pin Picofast | 4-Pin Eurofast |
|----------------|----------------|----------------|----------------|
| Female         |                | Male           |                |
|                |                |                |                |

# Splitters

## M12 Eurofast® 2-Branch Splitters with Valve Plugs

- Combine two Valve Plugs into one Eurofast
- For use with Eurofast J-boxes with 2 Signals Port
- Available with all Valve Plug styles (A, B, I and C)



| Part Number                           | Features   | Wiring Diagram |
|---------------------------------------|--|----------------|
| <b>VB2-RS 4.5T-*/2VAS 22-A528-*/*</b> | 220 V, 4.0 A, RS 4.5T = Grey PVC, 5.1 mm OD, 4x22 AWG, Valve plug = Grey PVC, 5.1 mm OD 3x20 AWG, combine two valve plugs into one cable. For use with 2 signal / port junction boxes. "A" style (18 mm) valve plugs.  | Diagram A      |
| <b>VB2-RS 4.5T-*/2VBS 2-A528-*/*</b>  | 220 V, 4.0 A, RS 4.5T = Grey PVC, 5.1 mm OD, 4x22 AWG, Valve plug = Grey PVC, 5.1 mm OD 3x20 AWG, combine two valve plugs into one cable. For use with 2 signal / port junction boxes. "B" style (10 mm) valve plugs.  |                |
| <b>VB2-RS 4.5T-*/2VIS 2-A528-*/*</b>  | 220 V, 4.0 A, RS 4.5T = Grey PVC, 5.1 mm OD, 4x22 AWG, Valve plug = Grey PVC, 5.1 mm OD 3x20 AWG, combine two valve plugs into one cable. For use with 2 signal / port junction boxes. "I" style (11 mm) valve plugs.  |                |
| <b>VB2-RS 4.5T-*/2TC8S 2-A528-*/*</b> | 220 V, 4.0 A, RS 4.5T = Grey PVC, 5.1 mm OD, 4x22 AWG, Valve plug = Grey PVC, 5.1 mm OD 3x20 AWG, combine two valve plugs into one cable. For use with 2 signal / port junction boxes. "C" style (8 mm) valve plugs.   |                |
| <b>VB2-RS 4.5T-*/2TC9S 2-A528-*/*</b> | 220 V, 4.0 A, RS 4.5T = Grey PVC, 5.1 mm OD, 4x22 AWG, Valve plug = Grey PVC, 5.1 mm OD 3x20 AWG, combine two valve plugs into one cable. For use with 2 signal / port junction boxes. "C" style (9.4 mm) valve plugs. |                |

\* Length in meters.

We reserve the right to make technical alterations without prior notice.

**Diagram A**

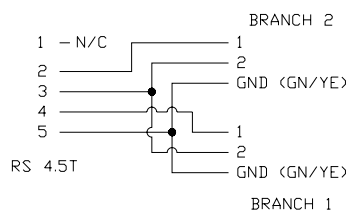



## M12 Eurofast® 2-Branch Splitters with Valve Plugs

### Specifications

|                       |   |                       |                                       |
|-----------------------|---|-----------------------|---------------------------------------|
| <b>Junction Body:</b> | Oil resistant yellow TPU  | <b>Coupling Nuts:</b> | Nickel plated brass                   |
| <b>Connector:</b>     | Oil resistant TPU body material, Nylon or TPU contact carrier         | <b>Cable:</b>         | See table                             |
| <b>Contacts:</b>      | Gold plated brass (Eurofast). Silver plated copper alloy (VALVE PLUG) | <b>Temperature:</b>   | -40 °C to +105 °C (-40 °F to +221 °F) |
|                       |   | <b>Protection:</b>    | IEC IP67                              |

- Cable Length:** Trunk - nominal 1 meter. Branches - nominal 0.3 meters. Other lengths available by request - consult factory.
- Cable Options:** Other jackets available by request - consult factory.
- Valve Options:** Available w/LED or LED+MOV, consult factory.
- Eurofast Options:** Stainless steel coupling nut add "V" to part number (RS .. to RSV ..). Nylon coupling nut add "K" to part number (RS .. to RSK ..). Right angle connectors, change part number (RS .. to WS..).

We reserve the right to make technical alterations without prior notice.

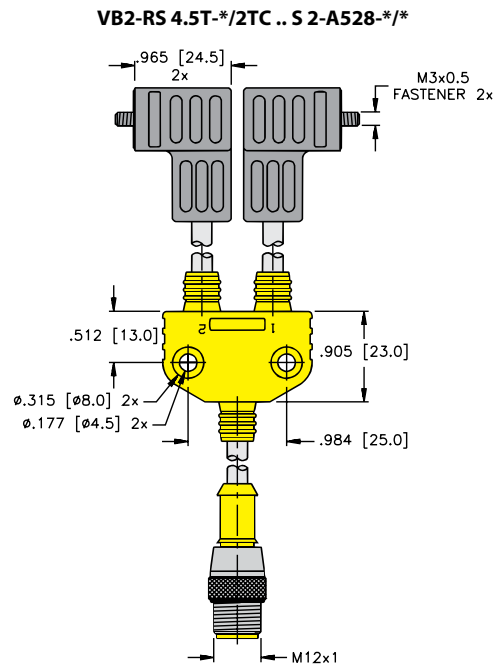
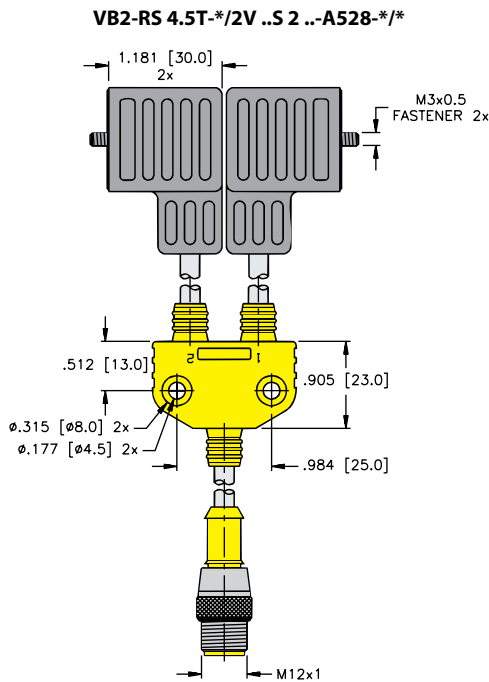

### Pinouts

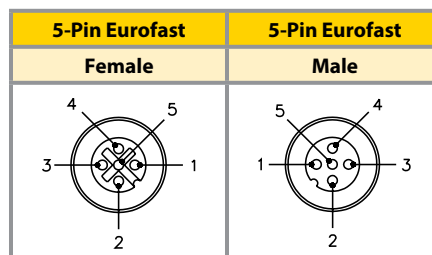

# Splitters

## M12 Eurofast® 4-Branch Splitters, Standard Wiring

- Combine four Sensors into one Cable
- Tough TPU Construction
- For 3-wire DC Sensors or Switches



| Housing | Part Number                         | Features  | Wiring Diagram  |
|---------|-------------------------------------|---|-----------------|
|         | <p><b>V6RSC-*/PKG3M-*/*/*/*</b></p> | <p>60 VAC/75 VDC, 2.0 A, RSC 6T = Grey PVC, 5.7 mm OD, 6x24 AWG, PKG = Yellow PVC, 4.4 mm OD, 3x24 AWG, combine four sensors into one cable</p> | <p>Standard</p> |

\* Length in meters.

We reserve the right to make technical alterations without prior notice.

### Wiring Diagram

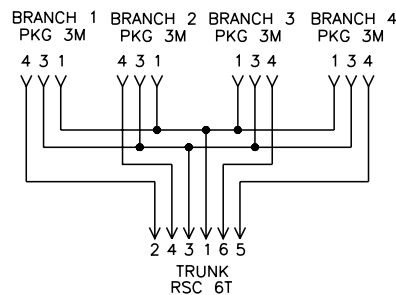

M12 Eurofast® 4-Branch Splitters, Standard Wiring

Specifications

|                       |   |                       |                                       |
|-----------------------|---|-----------------------|---------------------------------------|
| <b>Junction Body:</b> | Oil resistant yellow TPU                                      | <b>Coupling Nuts:</b> | Nickel plated brass                   |
| <b>Connector:</b>     | Oil resistant TPU body material, Nylon or TPU contact carrier | <b>Cable:</b>         | See table                             |
| <b>Contacts:</b>      | Gold plated brass   | <b>Temperature:</b>   | -40 °C to +105 °C (-40 °F to +221 °F) |
|                       |   | <b>Protection:</b>    | IEC IP67                              |

- Cable Length:** Trunk - nominal 1 meter. Branches - nominal 0.3 meters. Other lengths available by request - consult factory.
- Cable Options:** Standard cable jacket - grey PVC. TPU and other jackets available by request - consult factory.
- Connector Options:** (for legs with cable)  
Stainless steel coupling nut add "V" to part number (PKG to PKGV).
- Notes:** Mounting hole accepts #8 screw.

We reserve the right to make technical alterations without prior notice.

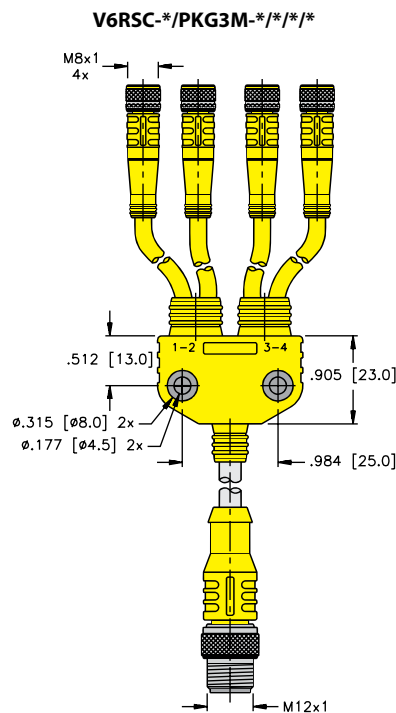

Pinouts

| 3-Pin  | 6-Pin |
|--------|-------|
| Female | Male  |
|        |       |

# Splitters

## M12 Eurofast® 4-Branch Splitters, Standard Wiring

- For use on Photoelectric Controls, Power Distribution and other Parallel-wired applications
- Tough TPU Construction



| Housing | Part Number                         | Features   | Wiring Diagram  |
|---------|-------------------------------------|--|-----------------|
|         | <p><b>V3RS-*/RK4-*/*/*/S651</b></p> | <p>60 VAC /75 VDC, 2.0 A, Yellow PVC, 4.4 mm OD, 3x24 AWG, parallel wired, 3 conductor</p> | <p>Parallel</p> |

\* Length in meters.

We reserve the right to make technical alterations without prior notice.

### Wiring Diagram

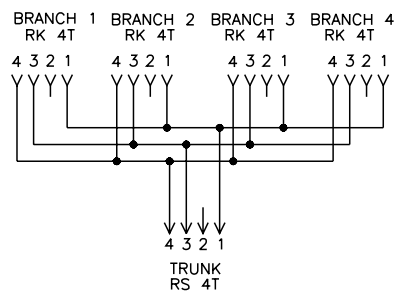

M12 Eurofast® 4-Branch Splitters, Standard Wiring

Specifications

|                       |   |                       |                                       |
|-----------------------|---|-----------------------|---------------------------------------|
| <b>Junction Body:</b> | Oil resistant yellow TPU                                      | <b>Coupling Nuts:</b> | Nickel plated brass                   |
| <b>Connector:</b>     | Oil resistant TPU body material, Nylon or TPU contact carrier | <b>Cable:</b>         | See table                             |
| <b>Contacts:</b>      | Gold plated brass   | <b>Temperature:</b>   | -40 °C to +105 °C (-40 °F to +221 °F) |
|                       |   | <b>Protection:</b>    | IEC IP67                              |

- Cable Length:** Trunk - nominal 1 meter. Branches - nominal 0.3 meters. Other lengths available by request - consult factory.
- Cable Options:** Standard cable jacket - grey PVC. TPU and other jackets available by request - consult factory.
- Connector Options:** (for legs with cable)  
 Stainless steel coupling nut add "V" to part number (RS to RSV, RK to RKV).  
 Nylon coupling nut add "K" to part number (RS to RSK, RK to RKK).  
 Right angle connectors, change part number (RS to WS, RK to WK).
- Notes:** Mounting holes accept #8 screw.

We reserve the right to make technical alterations without prior notice.

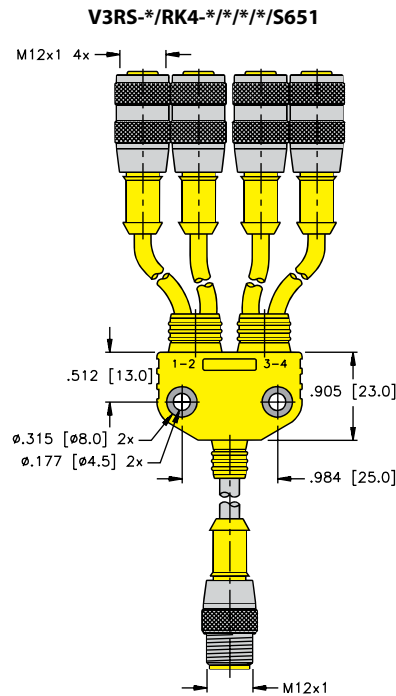

Pinouts

| 4-Pin  |      |
|--------|------|
| Female | Male |
|        |      |

# Splitters

## M12 Eurofast® 4-Branch Splitters, Parallel Wiring

- For use on Photoelectric Controls, Power Distribution and other Parallel-wired applications
- Tough TPU Construction



| Housing | Part Number                           | Features  | Wiring Diagram  |
|---------|---------------------------------------|---|-----------------|
|         | <p><b>V4RS-*/PKG4M-*/*/*/S651</b></p> | <p>125 VAC / VDC, 2.0 A, RS 4.4T = Grey PVC, 5.1 mm OD, 4x22 AWG, PKG 4M = Yellow PVC, 4.4 mm OD, 4x26 AWG, parallel wired, 4 conductor</p> | <p>Parallel</p> |

\* Length in meters.

We reserve the right to make technical alterations without prior notice.

### Wiring Diagram

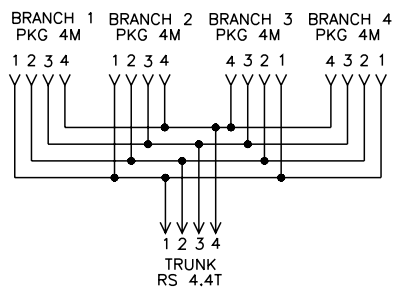

M12 Eurofast® 4-Branch Splitters, Parallel Wiring

Specifications

|                       |   |                       |                                       |
|-----------------------|---|-----------------------|---------------------------------------|
| <b>Junction Body:</b> | Oil resistant yellow TPU                                      | <b>Coupling Nuts:</b> | Nickel plated brass                   |
| <b>Connector:</b>     | Oil resistant TPU body material, Nylon or TPU contact carrier | <b>Cable:</b>         | See table                             |
| <b>Contacts:</b>      | Gold plated brass   | <b>Temperature:</b>   | -40 °C to +105 °C (-40 °F to +221 °F) |
|                       |   | <b>Protection:</b>    | IEC IP67                              |

- Cable Length:** Trunk - nominal 1 meter. Branches - nominal 0.3 meters. Other lengths available by request - consult factory.
- Cable Options:** Standard cable jacket - grey PVC. TPU and other jackets available by request - consult factory.
- Connector Options:** (for legs with cable)  
 Stainless steel coupling nut add "V" to part number (PSG to PSGV, PKG to PKGV).  
 Right angle connectors, change part number (RS to WS, RK to WK).
- Notes:** Mounting holes accept #8 screw.

We reserve the right to make technical alterations without prior notice.

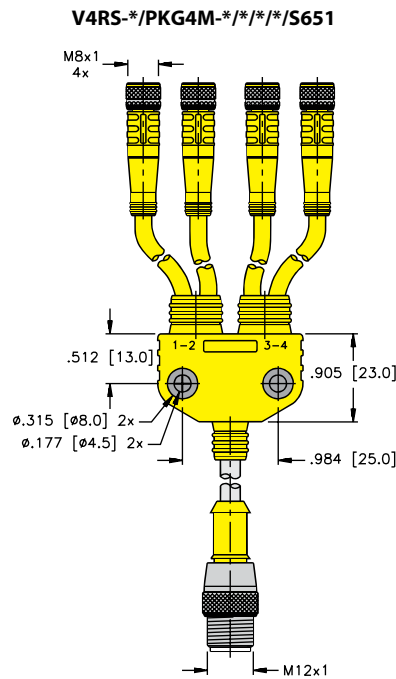

Pinouts

| 4-Pin  |      |
|--------|------|
| Female | Male |
|        |      |

# Splitters

## M12 Eurofast® 4-Branch Splitters, Parallel Wiring

- For use on Photoelectric Controls, Power Distribution and other Parallel-wired applications
- Tough TPU Construction



| Housing | Part Number                            | Features  | Wiring Diagram  |
|---------|--|---|-----------------|
|         | <p><b>V4FSM/RK4.4-*/*/*/*/S651</b></p> | <p>250 V, 2.0 A, RK 4.4T = Yellow PVC, 4.4 mm OD, 4x26 AWG, parallel wired, 4 conductor</p> | <p>Parallel</p> |

\* Length in meters.

We reserve the right to make technical alterations without prior notice.

### Wiring Diagram

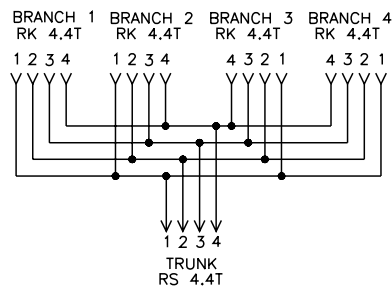



M12 Eurofast® 4-Branch Splitters, Parallel Wiring

Specifications

|                       |   |                       |                                       |
|-----------------------|---|-----------------------|---------------------------------------|
| <b>Junction Body:</b> | Oil resistant yellow TPU                                      | <b>Coupling Nuts:</b> | Nickel plated brass                   |
| <b>Connector:</b>     | Oil resistant TPU body material, Nylon or TPU contact carrier | <b>Cable:</b>         | See table                             |
| <b>Contacts:</b>      | Gold plated brass   | <b>Temperature:</b>   | -40 °C to +105 °C (-40 °F to +221 °F) |
|                       |   | <b>Protection:</b>    | IEC IP67                              |

**Cable Length:** Trunk - nominal 1 meter. Branches - nominal 0.3 meters. Other lengths available by request - consult factory.

**Cable Options:** Standard cable jacket - grey PVC. TPU and other jackets available by request - consult factory.

**Connector Options:** (for legs with cable)  
 Stainless steel coupling nut add "V" to part number (RS to RSV, RK to RKV).  
 Nylon coupling nut add "K" to part number (RS to RSK, RK to RKK).  
 Right angle connectors, change part number (RS to WS, RK to WK).

**Notes:** Mounting holes accept #8 screw.

V4FSM/RK4.4-\*/\*/\*/S651

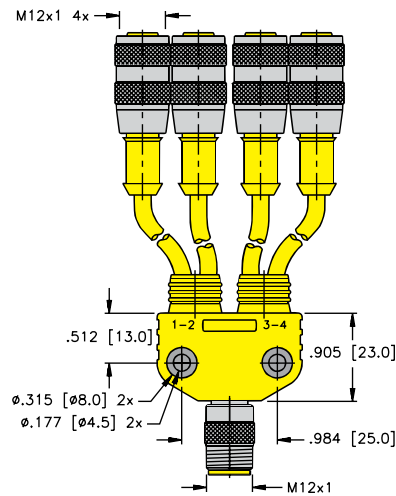

We reserve the right to make technical alterations without prior notice.

Pinouts

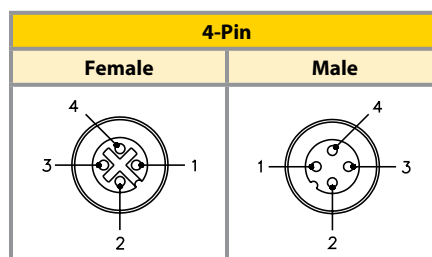

# Splitters

## M12 Eurofast® 4-Branch Splitters, Parallel Wiring

- For use on Photoelectric Controls, Power Distribution and other Parallel-wired applications
- Tough TPU Construction



| Housing | Part Number                             | Features   | Wiring Diagram  |
|---------|---|--|-----------------|
|         | <p><b>V4RS-*/RK4.4-*/**/**/S651</b></p> | <p>250 V, 2.0 A, RS 4.4T = Grey PVC, 5.1 mm OD, 4x22 AWG, RK 4.4T = Yellow PVC, 4.4 mm OD, 4x26 AWG, parallel wired, 4 conductor</p> | <p>Parallel</p> |

\* Length in meters.

We reserve the right to make technical alterations without prior notice.

### Wiring Diagram

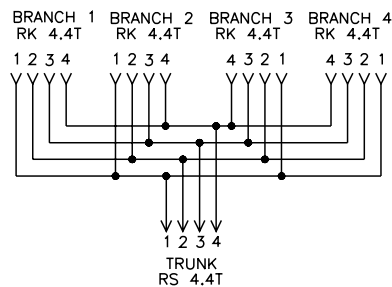

M12 Eurofast® 4-Branch Splitters, Parallel Wiring

Specifications

|                       |   |                       |                                       |
|-----------------------|---|-----------------------|---------------------------------------|
| <b>Junction Body:</b> | Oil resistant yellow TPU                                      | <b>Coupling Nuts:</b> | Nickel plated brass                   |
| <b>Connector:</b>     | Oil resistant TPU body material, Nylon or TPU contact carrier | <b>Cable:</b>         | See table                             |
| <b>Contacts:</b>      | Gold plated brass   | <b>Temperature:</b>   | -40 °C to +105 °C (-40 °F to +221 °F) |
|                       |   | <b>Protection:</b>    | IEC IP67                              |

**Cable Length:** Trunk - nominal 1 meter. Branches - nominal 0.3 meters. Other lengths available by request - consult factory.

**Cable Options:** Standard cable jacket - grey PVC. TPU and other jackets available by request - consult factory.

**Connector Options:** (for legs with cable)

Stainless steel coupling nut add "V" to part number (RS to RSV, RK to RKV).

Nylon coupling nut add "K" to part number (RS to RSK, RK to RKK).

Right angle connectors, change part number (RS to WS, RK to WK).

**Notes:** Mounting holes accept #8 screw.

V4RS-\*/RK4.4-\*/\*/\*/S651

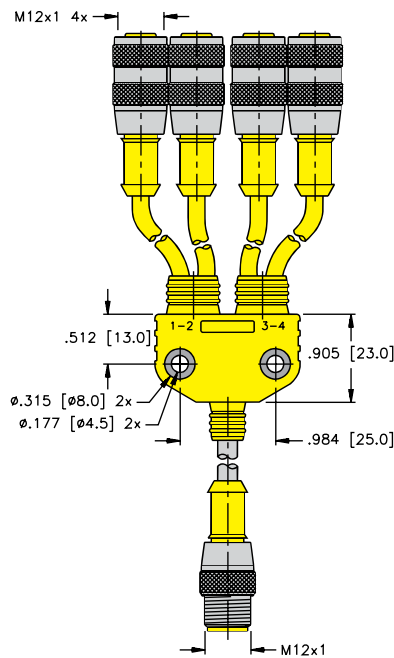

We reserve the right to make technical alterations without prior notice.

Pinouts

| 4-Pin  |      |
|--------|------|
| Female | Male |
|        |      |

# Splitters

## M12 Eurofast® 4-Branch Splitters, Series Wiring

- Combine four Sensors into one Cable
- Series Wired
- Tough TPU Construction
- For 3-wire DC Sensors or Switches



| Housing | Part Number                            | Features  | Wiring Diagram |
|---------|--|---|----------------|
|         | <p><b>V3RS-*/RK 4-*/**/**/S719</b></p> | <p>60 VAC/75 VDC, 2.0 A, Grey PVC, 4.4 mm OD, 3x24 AWG, series wired for and function PNP signals</p> | <p>Series</p>  |

\* Length in meters.

We reserve the right to make technical alterations without prior notice.

### Wiring Diagram

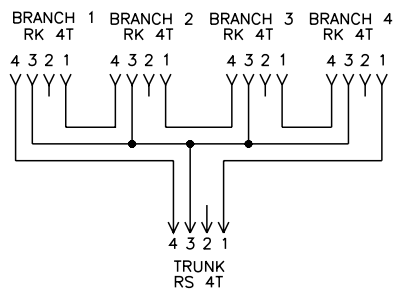

M12 Eurofast® 4-Branch Splitters, Series Wiring

Specifications

|                       |   |                       |                                       |
|-----------------------|---|-----------------------|---------------------------------------|
| <b>Junction Body:</b> | Oil resistant yellow TPU                                      | <b>Coupling Nuts:</b> | Nickel plated brass                   |
| <b>Connector:</b>     | Oil resistant TPU body material, Nylon or TPU contact carrier | <b>Cable:</b>         | See table                             |
| <b>Contacts:</b>      | Gold plated brass   | <b>Temperature:</b>   | -40 °C to +105 °C (-40 °F to +221 °F) |
|                       |   | <b>Protection:</b>    | IEC IP67                              |

**Cable Length:** Trunk - nominal 1 meter. Branches - nominal 0.3 meters. Other lengths available by request - consult factory.

**Cable Options:** Standard cable jacket - grey PVC. TPU and other jackets available by request - consult factory.

**Connector Options:** (for legs with cable)  
 Stainless steel coupling nut add "V" to part number (RS to RSV, RK to RKV).  
 Nylon coupling nut add "K" to part number (RS to RSK, RK to RKK).  
 Right angle connectors, change part number (RS to WS, RK to WK).

**Notes:** Mounting holes accept #8 screw.

We reserve the right to make technical alterations without prior notice.

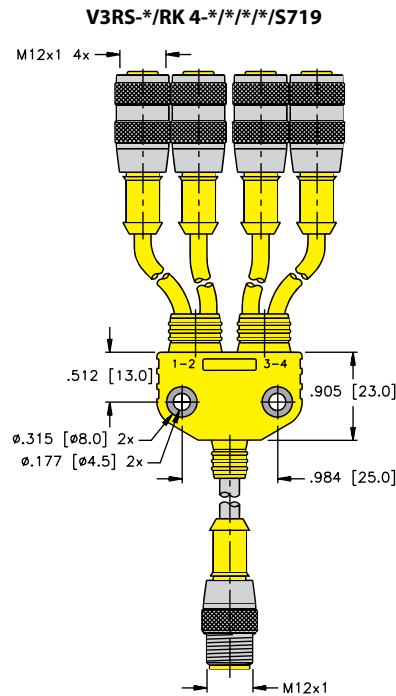

Pinouts

| 4-Pin  |      |
|--------|------|
| Female | Male |
|        |      |

# Splitters

## M8 Picofast® 2-Branch Compact Splitters, Standard and LED Wiring

- Combine two Sensors into one Cable
- For use on Cylinders and other Dual-Input applications
- Tough TPU Construction
- IEC IP67 Protection

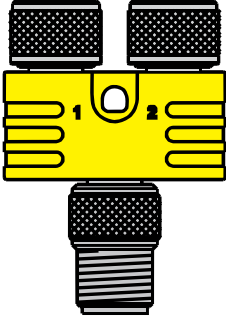

| Housing  | Part Number          | Features  | Wiring Diagram  |
|--|----------------------|---|-----------------|
|   | YP2-MFS 4/2MFK 3     | 125 V, 2 A, 2 Picofast branches, 3-wire & 1 Picofast trunk, 4-wire      | Standard 3-wire |
|  | YP2-PX2-MFS 4/2MFK 3 | 30 V, 2 A, 2 Picofast branches, 3-wire & 1 Picofast trunk, 4-wire, LEDs | LED 3-wire      |

We reserve the right to make technical alterations without prior notice.

### Wiring Diagrams

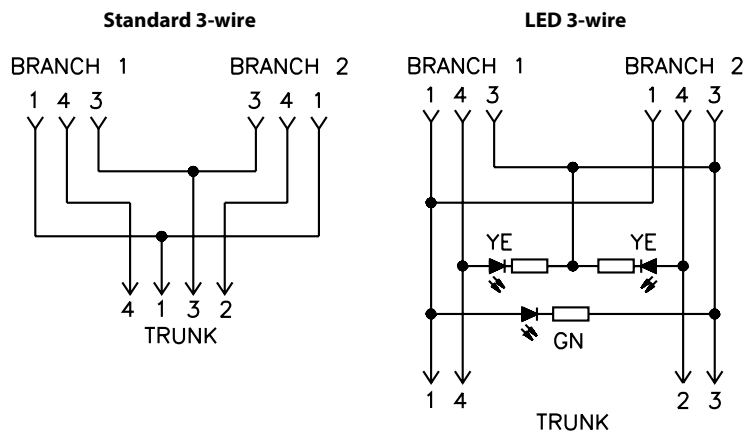

M8 Picofast® 2-Branch Compact Splitters, Standard and LED Wiring

Specifications

|                       |   |                       |                                      |
|-----------------------|---|-----------------------|--------------------------------------|
| <b>Junction Body:</b> | Oil resistant yellow TPU                                      | <b>Coupling Nuts:</b> | Nickel plated brass                  |
| <b>Connector:</b>     | Oil resistant TPU body material, Nylon or TPU contact carrier | <b>Temperature:</b>   | -30 °C to +80 °C (-22 °F to +176 °F) |
| <b>Contacts:</b>      | Gold plated brass   | <b>Protection:</b>    | NEMA 1, 3, 4, 6P and IEC IP67        |

**Notes:** Mounting hole accepts #4 screw.

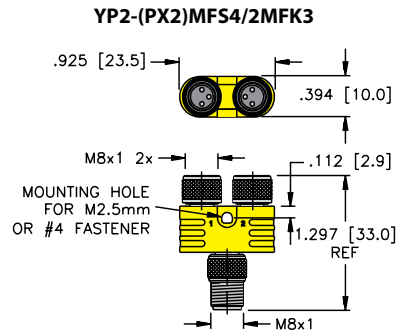

We reserve the right to make technical alterations without prior notice.

Pinouts

| 3-pin Picofast | 4-pin Picofast |
|----------------|----------------|
| Female         | Male           |
|                |                |

# Splitters

## M8 Picofast® 2-Branch Compact Splitters, Standard and Parallel Wiring

- Combine two Sensors into one Cable
- For use on Cylinders and other Dual-Input applications
- Tough TPU Construction
- IEC IP67 Protection



| Housing | Part Number              | Features   | Wiring Diagram       |
|---------|--------------------------|--|----------------------|
|         | YP2-MFS3/2PKG3M-*/*/S651 | 125 V, 4 A, PKG 3M = Yellow PVC, 4.4 mm OD, 3x24 AWG, 2 Picofast branches, 3-wire & 1 Picofast trunk, 3-wire | Parallel 3-wire      |
|         | YP2-MFS4/2PKG3M-*/*      | 125 V, 2 A, PKG 3M = Yellow PVC, 4.4 mm OD, 3x24 AWG, 2 Picofast branches, 3-wire & 1 Picofast trunk, 4-wire | Standard 3 to 4-wire |
|         | YP2-MFS4/2PKG4M-*/*/S651 | 125 V, 2 A, PKG 4M = Yellow PVC, 4.4 mm OD, 4x26 AWG, 2 Picofast branches, 4-wire & 1 Picofast trunk, 4-wire | Parallel 4-wire      |

\* Length in meters.

We reserve the right to make technical alterations without prior notice.

### Wiring Diagrams

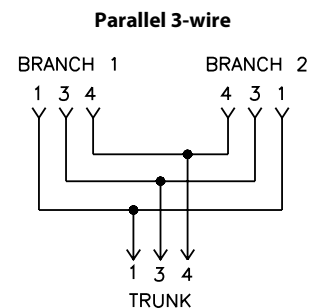
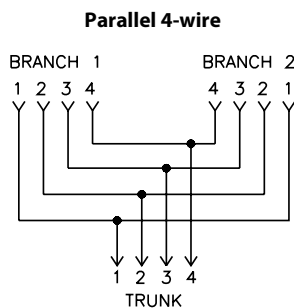
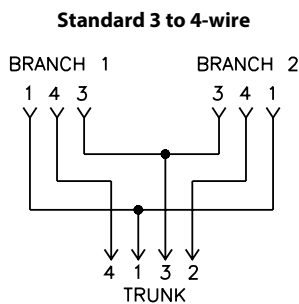



M8 Picofast® 2-Branch Compact Splitters, Standard and Parallel Wiring

Specifications

|                       |   |                       |                                       |
|-----------------------|---|-----------------------|---------------------------------------|
| <b>Junction Body:</b> | Oil resistant yellow TPU                                      | <b>Coupling Nuts:</b> | Nickel plated brass                   |
| <b>Connector:</b>     | Oil resistant TPU body material, Nylon or TPU contact carrier | <b>Cable:</b>         | See table                             |
| <b>Contacts:</b>      | Gold plated brass   | <b>Temperature:</b>   | -40 °C to +105 °C (-40 °F to +221 °F) |
|                       |   | <b>Protection:</b>    | NEMA 1, 3, 4, 6P and IEC IP67         |

- Cable Length:** Branches - nominal 0.3 meters. Other lengths available by request - consult factory.
- Cable Options:** Standard cable jacket - grey/yellow PVC. TPU and other jackets available by request - consult factory.
- Connector Options:** (for legs with cable)  
Stainless steel coupling nut add "V" to part number (PKG to PKGV, PSG to PSGV, RK to RKV).
- Notes:** Mounting hole accepts #4 screw.

YP2-MFS3(4)/2PKG3(4)M-\*/\*/(S651)

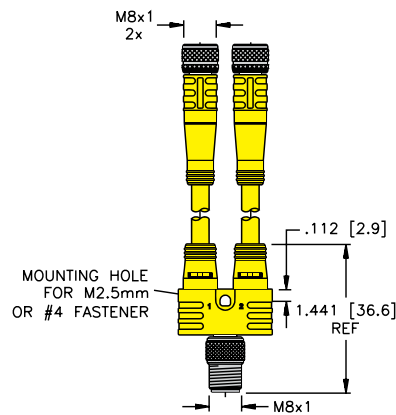

We reserve the right to make technical alterations without prior notice.

Pinouts

| 3-Pin Picofast | 4-pin Picofast | 3-Pin Picofast | 4-pin Picofast |
|----------------|----------------|----------------|----------------|
| Female         |                | Male           |                |
|                |                |                |                |

# Splitters

## M8 Picofast® 2-Branch Compact Splitters, Standard and Parallel Wiring

- Combine two Sensors into one Cable
- For use on Cylinders and other Dual-Input applications
- Tough TPU Construction
- IEC IP67 Protection



| Housing | Part Number               | Features  | Wiring Diagram       |
|---------|---------------------------|---|----------------------|
|         | YP2-PSG3M-*/2PKG3M-*/S651 | 125 V, 4 A, PSG 3M & PKG3M = Yellow PVC, 4.4 mm OD, 3x24 AWG, 2 Picofast branches, 3-wire & 1 Picofast trunk, 3-wire                                  | Parallel 3-wire      |
|         | YP2-PSG4M-*/2PKG3M-*/S651 | 125 V, 2 A, PSG 4M = Yellow PVC, 4.4 mm OD, 4x26 AWG, PKG3M = Yellow PVC, 4.4 mm OD, 3x24 AWG, 2 Picofast branches, 3-wire & 1 Picofast trunk, 4-wire | Standard 3 to 4-wire |
|         | YP2-PSG4M-*/2PKG4M-*/S651 | 125 V, 2 A, PSG 4M & PKG4M = Yellow PVC, 4.4 mm OD, 4x26 AWG, 2 Picofast branches, 4-wire & 1 Picofast trunk, 4-wire                                  | Parallel 4-wire      |
|         | YP2-PSG6M-*/2PKG6M-*/S651 | 125 V, 2 A, PSG 6M & PKG 6M = Yellow PVC, 4.5 mm OD, 6x26 AWG, 2 Picofast branches, 6-wire & 1 Picofast trunk, 6-wire                                 | Parallel 6-wire      |

We reserve the right to make technical alterations without prior notice.

\* Length in meters.

### Wiring Diagrams

Standard, 3 to 4-wire

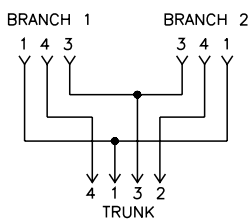

Parallel, 3-wire

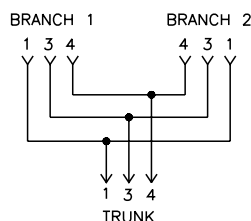

Parallel, 4-wire

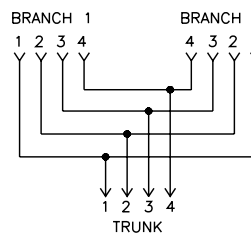

Parallel, 6-wire

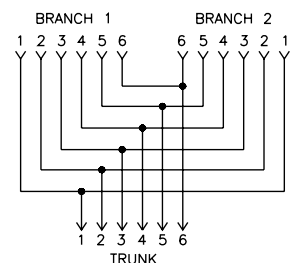

M8 Picofast® 2-Branch Compact Splitters, Standard and Parallel Wiring

Specifications

|                       |   |                       |                                       |
|-----------------------|---|-----------------------|---------------------------------------|
| <b>Junction Body:</b> | Oil resistant yellow TPU                                      | <b>Coupling Nuts:</b> | Nickel plated brass                   |
| <b>Connector:</b>     | Oil resistant TPU body material, Nylon or TPU contact carrier | <b>Cable:</b>         | See table                             |
| <b>Contacts:</b>      | Gold plated brass   | <b>Temperature:</b>   | -40 °C to +105 °C (-40 °F to +221 °F) |
|                       |   | <b>Protection:</b>    | NEMA 1, 3, 4, 6P and IEC IP67         |

**Cable Length:** Trunk - nominal 1 meter. Branches - nominal 0.3 meters. Other lengths available by request - consult factory.  
**Cable Options:** Standard cable jacket - grey/yellow PVC. TPU and other jackets available by request - consult factory.  
**Connector Options:** (for legs with cable) Stainless steel coupling nut add "V" to part number (PKG to PKGV, PSG to PSGV, RK to RKV).  
**Notes:** Mounting hole accepts #4 screw.

YP2-PSG3(4,6)M-\*/2PKG3(4,6)M-\*/\*(/S651)

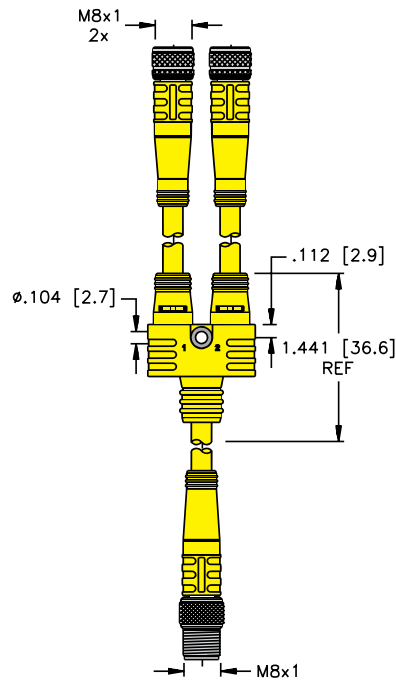

We reserve the right to make technical alterations without prior notice.

Pinouts

| 3-pin Picofast | 4-pin Picofast | 6-pin Picofast | 3-pin Picofast | 4-pin Picofast | 6-pin Picofast |
|----------------|----------------|----------------|----------------|----------------|----------------|
| Female         |                |                | Male           |                |                |
|                |                |                |                |                |                |

# Splitters

## M8 Picofast® 2-Branch Compact Splitters, Standard Wiring

- Combine two Sensors into one Cable
- For use on Cylinders and other Dual-Input applications
- Tough TPU Construction
- IEC IP67 Protection

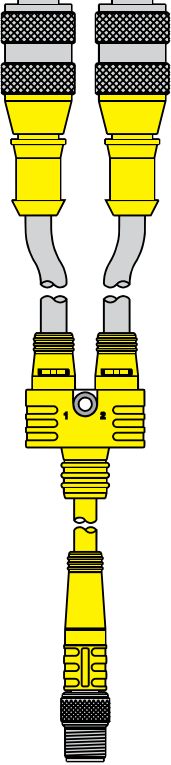

| Housing  | Part Number                  | Features  | Wiring Diagram  |
|--|------------------------------|---|-----------------|
|  | <p>YP2-PSG4M-*/2RK4T-*/*</p> | <p>125 V, 2 A, PSG 4M = Yellow PVC, 4.4 mm OD, 4x26 AWG, RK 4T = Grey PVC, 5.1 mm OD, 3x20 AWG, 2 Eurofast® branches, 4-wire &amp; 1 Picofast trunk, 4-wire</p> | <p>Standard</p> |

We reserve the right to make technical alterations without prior notice.

\* Length in meters.

**Wiring Diagram**

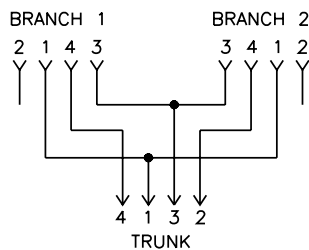

M8 Picofast® 2-Branch Compact Splitters, Standard Wiring

Specifications

|                       |   |                       |                                       |
|-----------------------|---|-----------------------|---------------------------------------|
| <b>Junction Body:</b> | Oil resistant yellow TPU                                      | <b>Coupling Nuts:</b> | Nickel plated brass                   |
| <b>Connector:</b>     | Oil resistant TPU body material, Nylon or TPU contact carrier | <b>Cable:</b>         | See table                             |
| <b>Contacts:</b>      | Gold plated brass   | <b>Temperature:</b>   | -40 °C to +105 °C (-40 °F to +221 °F) |
|                       |   | <b>Protection:</b>    | NEMA 1, 3, 4, 6P and IEC IP67         |

- Cable Length:** Trunk - nominal 1 meter. Branches - nominal 0.3 meters. Other lengths available by request - consult factory.
- Cable Options:** Standard cable jacket - grey/yellow PVC. TPU and other jackets available by request - consult factory.
- Connector Options:** (for legs with cable) Stainless steel coupling nut add "V" to part number (PKG to PKGV, PSG to PSGV, RK to RKV).
- Notes:** Mounting hole accepts #4 screw.

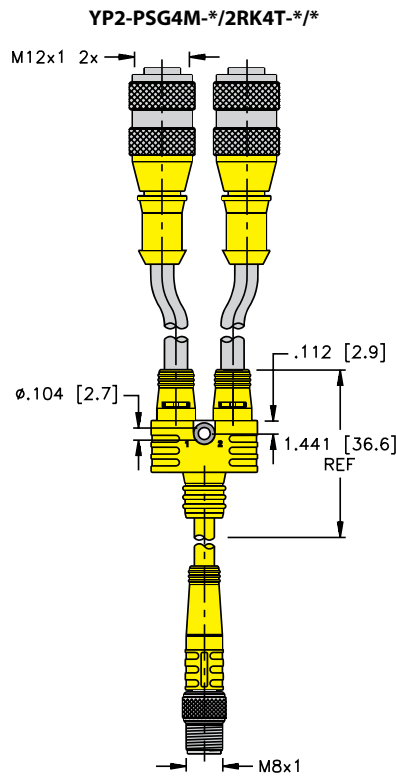

We reserve the right to make technical alterations without prior notice.

Splitters

Pinouts

| 4-pin Eurofast® | 4-pin Picofast |
|-----------------|----------------|
| Female          | Male           |
|                 |                |

# Splitters

## M8 Picofast® 4-Branch Splitters, Parallel Wiring

- For use on Photoelectric Controls, Power Distribution and other Parallel-wired applications
- Tough TPU Construction



| Housing | Part Number                            | Features  | Wiring Diagram  |
|---------|--|---|-----------------|
|         | <p><b>V3PSG-*/PKG3Z-*/*/*/S651</b></p> | <p>125 V, 2.0 A, Yellow PVC, 4.4 mm OD, 3x24 AWG, parallel wired, 3 conductor</p> | <p>Parallel</p> |

\* Length in meters.

We reserve the right to make technical alterations without prior notice.

### Wiring Diagram

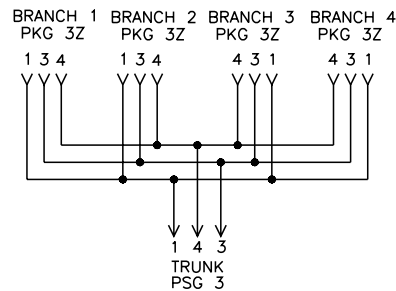

M8 Picofast® 4-Branch Splitters, Parallel Wiring

Specifications

|                       |   |                       |                                       |
|-----------------------|---|-----------------------|---------------------------------------|
| <b>Junction Body:</b> | Oil resistant yellow TPU                                      | <b>Coupling Nuts:</b> | Nickel plated brass                   |
| <b>Connector:</b>     | Oil resistant TPU body material, Nylon or TPU contact carrier | <b>Cable:</b>         | See table                             |
| <b>Contacts:</b>      | Gold plated brass   | <b>Temperature:</b>   | -40 °C to +105 °C (-40 °F to +221 °F) |
|                       |   | <b>Protection:</b>    | IEC IP67                              |

**Cable Length:** Trunk - nominal 1 meter. Branches - nominal 0.3 meters. Other lengths available by request - consult factory.  
**Cable Options:** Standard cable jacket - grey PVC. TPU and other jackets available by request - consult factory.  
**Notes:** Mounting holes accept #8 screw.

V3PSG-\*/PKG3Z-\*/\*\*/\*/\*/S651

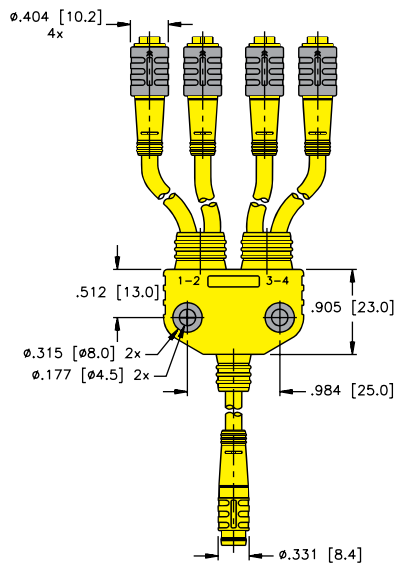

We reserve the right to make technical alterations without prior notice.

Splitters

Pinouts

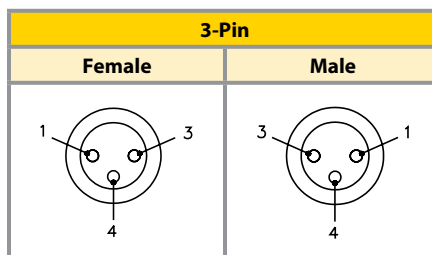

# Splitters

## M8 Picofast® 4-Branch Splitters, Parallel Wiring

- For use on Photoelectric Controls, Power Distribution and other Parallel-wired applications
- Tough TPU Construction



| Housing | Part Number                                 | Features  | Wiring Diagram  |
|---------|---|---|-----------------|
|         | <p><b>V4PSGM-*/PKG4M-*/**/*/*/*S651</b></p> | <p>125 V, 2.0 A, yellow PVC, 4.4 mm OD, 4x26 AWG, parallel wired, 4 conductor</p> | <p>Parallel</p> |

\* Length in meters.

We reserve the right to make technical alterations without prior notice.

### Wiring Diagram

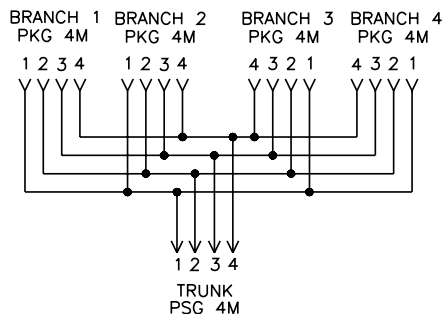



M8 Picofast® 4-Branch Splitters, Parallel Wiring

Specifications

|                       |   |                       |                                       |
|-----------------------|---|-----------------------|---------------------------------------|
| <b>Junction Body:</b> | Oil resistant yellow TPU                                      | <b>Coupling Nuts:</b> | Nickel plated brass                   |
| <b>Connector:</b>     | Oil resistant TPU body material, Nylon or TPU contact carrier | <b>Cable:</b>         | See table                             |
| <b>Contacts:</b>      | Gold plated brass   | <b>Temperature:</b>   | -40 °C to +105 °C (-40 °F to +221 °F) |
|                       |   | <b>Protection:</b>    | IEC IP67                              |

**Cable Length:** Trunk - nominal 1 meter. Branches - nominal 0.3 meters. Other lengths available by request - consult factory.  
**Cable Options:** Standard cable jacket - grey PVC. TPU and other jackets available by request - consult factory.  
**Connector Options:** (for legs with cable) Stainless steel coupling nut add "V" to part number (PSG to PSGV, PKG to PKGV).  
**Notes:** Mounting holes accept #8 screw.

V4PSGM-\*/PKG4M-\*/\*\*/\*\*/S651

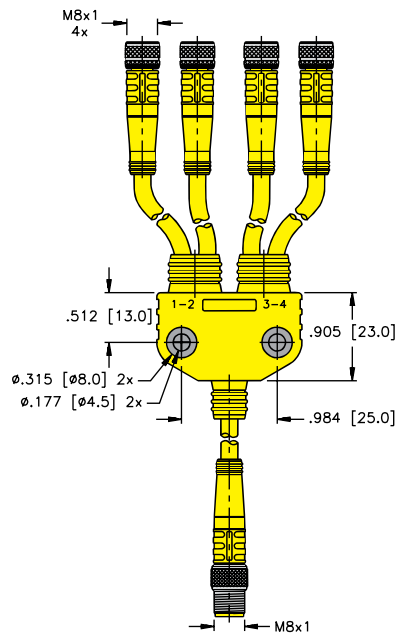

We reserve the right to make technical alterations without prior notice.

Pinouts

| 4-Pin  |      |
|--------|------|
| Female | Male |
|        |      |

# Splitters

## M8 Picofast® to M12 Eurofast® Adapters

- Enables Picofast and Eurofast Connectors to be interchanged
- Compact size saves space
- Eurofast Connection has Anti-vibration Coupling Nut



| Part Number            | Features  | Wiring Diagram |
|------------------------|---|----------------|
| <b>FKMR 4-ESM 3S</b>   | 60 VAC/75 VDC, 4.0 A, female Eurofast, male snap-lock Picofast connector, 3-pin |                |
| <b>FKMR 4.4-ESM 4S</b> | 30 VAC/36 VDC, 4.0 A, female Eurofast, male snap-lock Picofast connector, 4-pin |                |
| <b>FSMR 4-SKM 3</b>    | 60 VAC/75 VDC, 4.0 A, male Eurofast, female threaded Picofast connector, 3-pin  |                |
| <b>FSMR 4.4-SKM 4</b>  | 30 VAC/36 VDC, 4.0 A, male Eurofast, female threaded Picofast connector, 4-pin  |                |

To add mounting hole, add /S857 to the end of the part number.

We reserve the right to make technical alterations without prior notice.

M8 Picofast® to M12 Eurofast® Adapters

Specifications

**Junction Body:** Oil resistant blue-gray TPU  
**Connector:** Nylon or TPU contact holder  
**Contacts:** Gold plated brass

**Coupling Nuts:** Nickel plated brass  
**Temperature:** -30 °C to +80 °C (-22 °F to +176 °F)  
**Protection:** NEMA 1, 3, 4, 6P and IEC IP67

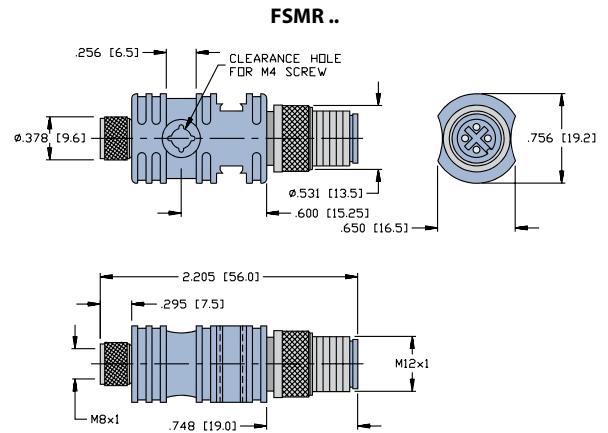
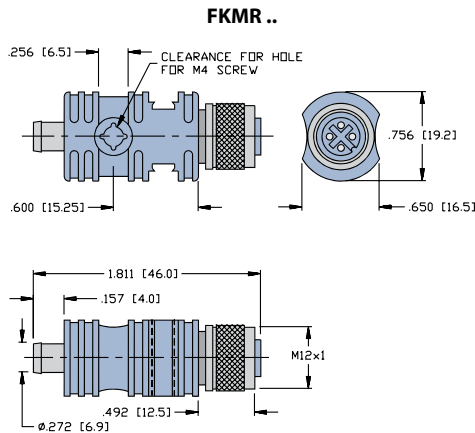

We reserve the right to make technical alterations without prior notice.

Pinouts

| 3-pin Picofast | 4-pin Picofast | 4-Pin Eurofast | 3-pin Picofast | 4-pin Picofast | 4-Pin Eurofast |
|----------------|----------------|----------------|----------------|----------------|----------------|
| Female         |                |                | Male           |                |                |
|                |                |                |                |                |                |

# Splitters

## Multibox® 2 - Branch Molded Splitters

- Consolidate two Sensors/Actuators into one
- M8 Picofast® or M12 Eurofast® Connector Branches
- Tough TPU Construction
- IEC IP67 Protection



| Housing | Part Number   | Features   | Wiring Diagram |
|---------|---|--|----------------|
|         | <b>YB2-FSM 4.5-2FKM 4.5</b><br><b>(Fits 8MB12 J-boxes)</b>    | 2 Eurofast branches, black TPU, 80 °C, 30 VAC/36 VDC, 4 A, combine two sensors/actuators with Eurofast connector branches into one                   |                |
|         | <b>YB2-FSM 4.5-2FKM 4.5/S1063</b><br><b>(Fits VB J-boxes)</b> | 2 Eurofast branches, grey TPU, 80 °C, 30 VAC/36 VDC, 4 A, combine two sensors/actuators with Eurofast connector branches into one                    |                |
|         | <b>YB2-FSM 4.5-2FKM 4.5-P7X3</b>                              | 2 Eurofast branches, translucent black TPU, 80 °C, 30 VDC, 4 A, 3 LEDs, PNP, combine two sensors/actuators with Eurofast connector branches into one |                |
|         | <b>YB2-FSM 4.4/2PKG 3M</b>                                    | 2 Picofast branches, black TPU, 80 °C, 30 VAC/36 VDC, 2 A, combine two sensors/actuators with Picofast connector branches into one                   |                |
|         | <b>YB2-FSM 4.4/2PKG 3M-P7X3</b>                               | 2 Picofast branches, translucent black TPU, 80 °C, 30 VDC, 2 A, 3 LEDs, PNP, combine two sensors/actuators with Picofast connector branches into one |                |
|         | <b>YB22-FSM 4.5/2FKM 4.5/S771</b>                             | 2 Eurofast branches, black TPU, 80 °C, 30 VAC/36 VDC, 4 A, combine two sensors/actuators with Eurofast connector branches into one                   |                |
|         | <b>YB22-PX3-FSM 4.5/2FKM 4.5</b>                              | 2 Eurofast branches, transparent TPU, 80 °C, 36 VDC, 4 A, 3 LEDs, PNP, combine two sensors/actuators with Eurofast connector branches into one       |                |

We reserve the right to make technical alterations without prior notice.

Standard coupling nut material is nickel plated brass.

### Pinouts

| 5-Pin Eurofast | 3-Pin Picofast | 5-Pin Eurofast | 4-Pin Eurofast |
|----------------|----------------|----------------|----------------|
| Female         |                | Male           |                |
|                |                |                |                |

---

|  |            |
|--|------------|
| <b>Turck Standards</b>                             | <b>W2</b>  |
| <b>NRTL and RoHS</b>                               | <b>W3</b>  |
| <b>Shielded Cordsets</b>                           | <b>W4</b>  |
| <b>IP Protection Class, IEC, NEMA and NEMA 250</b> | <b>W5</b>  |
| <b>Conversion Charts</b>                           | <b>W9</b>  |
| <b>NEC</b>   | <b>W10</b> |
| <b>Cable Applications</b>                          | <b>W11</b> |
| <b>Cable Selection Guide</b>                       | <b>W13</b> |
| <b>Glossary</b>                                    | <b>W16</b> |

---

# Connectivity Products

## Turck Standards

One or more of the following standards may apply to products or components of products in this catalog. This section is intended to provide a reference to the applicable standards only. Original or facsimiles of the original standards documents should be used for interpretation. It is the responsibility of the user to determine the suitability of use of the products represented in this catalog.

## ANSI/B93.55M

Generally defines the geometry and connection scheme of “mini” type connectors used in fluid power (valve) applications. It defines the numerical marking of the pins and the conductor size and colors for 3 and 5 pin versions. This specification was the basis for the so-called “automotive” standard conductor colors that are widely used on sensors.

## CENELEC EN 50 044

Identifies connections for inductive proximity switches. The specification defines conductor colors for proximity switches with 2, 3, or 4 conductors. It also defines numerical marking of the terminals, whether quick disconnect, or not. Turck sensors and recommended cordsets that apply within the scope of the standard comply with CENELEC EN 50 044. The conventions defined in this standard have been widely adopted in industry to include photoelectric controls and other related sensing devices.

## CSA

The Canadian Standards Association is a not-for-profit membership-based association serving business, industry, government and consumers in Canada and the global marketplace.

Is the CSA mark valid across America?

**Yes.** CSA International is accredited by the Occupational Health and Safety Administration (OSHA) as a Nationally Recognized Testing Laboratory (NRTL). The CSA tests to the same American industry standards as other accredited laboratories, regardless of who authored or published the standard. CSA marks are recognized and accepted throughout America by federal, state and local authorities.

## DIN 43650

Defines the geometry and other characteristics of the “square” connectors most frequently used on hydraulic and pneumatic solenoid valves and other devices in the fluid power industry.

## MSHA

The Mine Safety and Health Administration - a US Government agency that ensures and regulates safety for mines and mine workers. The MSHA approval is required for products used in underground mines, including electrical equipment, power cords, and instrumentation components.

The MSHA standards require special fire-resistant properties and characteristics that prevent the propagation of flames.

## IEC 61076-2-101

Defines the geometry and other characteristics of the M12x1 family of threaded connectors used to connect control and measurement devices in industrial environments.

## IEC 61076-2-104

Defines the geometry and other characteristics of the M8x1 family of threaded and snap connectors used to connect control and measurement devices in industrial environments.

**NRTL**

Nationally Recognized Test Laboratory - An independent laboratory authorized by the US Government to perform product safety evaluations. Test laboratories must meet government laboratory standards, and are audited annually by OSHA to maintain this credential. UL standards are adopted by the US government and OSHA as being "Safety Standards", and these accredited labs then use the UL standards to perform product evaluations.

The Canadian Standards Association (CSA) is authorized as a NRTL to perform product evaluations and tests to the UL Standards. The certification mark "CSA NRTL/C" is then applied to products that satisfy all construction and performance criteria for both US and Canada. This certification mark is generally accepted by local building, safety, and quality agencies as meeting safety, construction, and performance criteria in both the US and Canada.

**RoHS (Restriction of Hazardous Substances in Electrical and Electronic Equipment)**

In Europe, the RoHS directive is the legal basis for the ban of certain materials (lead and other specific heavy metals) in electric and electronic products. This directive was adopted and implemented in Europe as of July 1st, 2006.



This directive is geared towards high volume consumer goods. Turck is not required to adopt the directive, but is affected by the legal requirements which prescribe that only lead-free products and components to be sold in Europe. Turck, however, is engaged in testing lead-free soldering and substitute substances/components in support of our commitment to the environment. The main issue we had to overcome to become RoHS compliant was our solder material that contained lead. We have tested and verified a RoHS approved solder material which was implemented as of May 1st, 2006 and a RoHS logo will be added to bag labels for those parts. Please be aware that there are certain products like PCBs and ITC/PLTC cable that will continue to contain restricted substances.

## Shielded Cordsets

Whenever wire is used to transmit electrical data, it is possible for the wire to absorb external noise, possibly changing the characteristics of the electrical signal, or to give off noise that could cause changes in other electrical components that are near. Shielding is the act of placing conductive material between the potential noise emitters and receivers.

Electrical noise is usually classified as electro-magnetic interference (EMI) or radio frequency interference (RFI).

Turck offers a number of shielding options:

1. Foil shield with drain, drain not connected

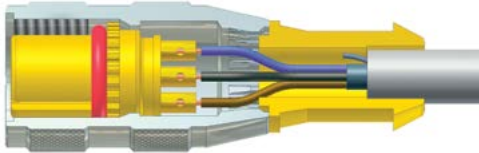

3. Foil and braid shield with shield tied to coupling nut

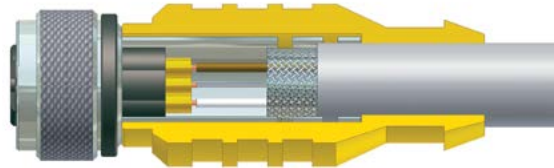

2. Foil shield with drain, drain connected to a pin

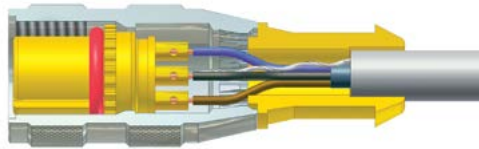

4. Aluminum armored cable with armor tied to coupling nut



For a shield to be effective, it must be tied to a ground at some point. It is usually preferred to not tie the shield to ground at more than one point to avoid ground loops. A shield not tied to a ground will reflect some noise and is better than no shield at all, but will be much more effective if tied to a ground.

High frequency noise, RFI, is handled well with a foil shield. The wavelength of RFI is usually small and can pass through the 'holes' in a braided shield. EMI is usually larger wavelengths and needs a braided shield to increase the mass of shielding material to be effective.

Aluminum armored cables provide the ultimate in noise immunity as they are basically flexible conduit.

Select the shielded cordset that best meets your needs. If it is easier to tie the shield to ground inside the panel, the foil/drain with the drain not connected inside the cordset is a good choice. If you can connect the drain via a pin inside the device being connected, the foil/drain with the drain connected to a pin is a good choice. Any environments with EMI noise from things like large motors or welding equipment will benefit from a braided shield tied to the coupling nut.

Turck shielded cordsets with the shield tied to the coupling nut offer complete shielding for the entire length of the cordset. A metal sleeve inside the molded body connects the braid/foil shield of the cable to the metal coupling nut with no loss of shielding potential.

Turck armored cordsets are the ultimate in shielded connectors. A Turck patented process allows the interlocked aluminum armor to be connected directly to the coupling nut offering the same protection as running conductors inside metal conduit.



**IP Protection Class**

| IP  | Dust Protection |                    |                      |                     |                     |                   |               |
|---|-----------------|--------------------|----------------------|---------------------|---------------------|-------------------|---------------|
|   | 0_ Unprotected  | 1_ Objects ≥ 50 mm | 2_ Objects ≥ 12.5 mm | 3_ Objects ≥ 2.5 mm | 4_ Objects ≥ 1.0 mm | 5_ Dust Protected | 6_ Dust Tight |
| <b>_0 Unprotected</b>                                       | IP 00           | IP 10              | IP 20                | IP 30               | IP 40               | IP 50             | IP 60         |
| <b>_1 Dripping Water</b>                                    |                 | IP 11              | IP 21                | IP 31               | IP 41               | IP 51             | IP 61         |
| <b>_2 Dripping Water on 15° slant</b>                       |                 | IP 12              | IP 22                | IP 32               | IP 42               | IP 52             | IP 62         |
| <b>_3 Spraying Water</b>                                    |                 |                    | IP 23                | IP 33               | IP 43               | IP 53             | IP 63         |
| <b>_4 Splashing Water</b>                                   |                 |                    |                      | IP 34               | IP 44               | IP 54             | IP 64         |
| <b>_4K Splashing Water High Pressure</b>                    |                 |                    |                      | IP 34K              | IP 44K              | IP 54K            | IP 64K        |
| <b>_5 Jet Water</b>   |                 |                    |                      |                     |                     | IP 55             | IP 65         |
| <b>_6 Intense Jet Water</b>                                 |                 |                    |                      |                     |                     | IP 56             | IP 66         |
| <b>_6K Intense Jet Water High Pressure</b>                  |                 |                    |                      |                     |                     | IP 56K            | IP 66K        |
| <b>_7 Temporary immersion</b>                               |                 |                    |                      |                     |                     |                   | IP 67         |
| <b>_8 Continuous immersion as specified by manufacturer</b> |                 |                    |                      |                     |                     |                   | IP 68         |
| <b>_9K Water at high pressure/Steam jet cleaning</b>        |                 |                    |                      |                     |                     |                   | IP 69K        |

We reserve the right to make technical alterations without prior notice.

Water Protection

Reference Section

## Ingress Protection Classes- IEC 60529

| First ID Number | Protection from penetration of... | Protection from penetration of...  |
|-----------------|-----------------------------------|--|
| 0               | Unprotected                       | N/A  |
| 1               | Solid Foreign Particles Ø50 mm    | No full penetration of sphere with Ø50 mm  |
| 2               | Solid Foreign Particles Ø12.5 mm  | No full penetration of sphere with Ø12.5 mm  |
| 3               | Solid Foreign Particles Ø2.5 mm   | No penetration of rod with Ø2.5 mm   |
| 4               | Solid Foreign Particles Ø1.0 mm   | No penetration of wire with Ø1.0 mm  |
| 5               | Dust                              | Dust may only penetrate in such quantity that function and safety are not impacted |
| 6               | Dust                              | No penetration of dust   |

| First ID Number | Protection from penetration of...   | Protection from penetration of...   |
|-----------------|---|---|
| 0               | Unprotected   | N/A   |
| 1               | Dripping water  | Vertically falling drips may not cause any damage   |
| 2               | Dripping water when the enclosure is in a slanted position of up to 15 °C | Vertically falling drips may not cause any damage   |
| 3               | Spraying water  | Spraying water, which is sprayed in a perpendicular angle of up to 60 °C may not cause any damage   |
| 4               | Splashing water   | Water splashing against the enclosure from every direction may not cause any damage   |
| 4K              | Splashing water with increased pressure                                   | Water splashing against the enclosure from every direction and with increased pressure may not cause any damage   |
| 5               | Jet water   | Water which is hosed against the enclosure from every direction may not cause damage  |
| 6               | Intense jet water   | Water which is hosed against the enclosure with high intensity may not cause any damage   |
| 6K              | Intense jet water with increased pressure                                 | Water which is hosed against the enclosure with high intensity and increased pressure may not cause any damage  |
| 7               | Temporary immersion in water  | Water may not enter the enclosure in such quantity as to cause damage when the enclosure is held under water for a set period of time using predetermined pressure (1 m for 30 min)   |
| 8               | Continuous immersion in water   | Water may not enter the enclosure in such quantity as to cause damage when the enclosure is held under water for a set period of time using predetermined pressure (Turck standard is 6' of water, and other chemicals, for a period of 24 hours) |
| 9K              | Water at high-pressure/steam jet cleaning                                 | Water which is directed against the enclosure from every direction with extremely high pressure may not cause any damage (14 to 16 l/min at 8,000 to 10,000 kPa)  |

We reserve the right to make technical alterations without prior notice.

**NEMA Standards**

| NEMA  |             | NEMA 1 | NEMA 2 | NEMA 12 | NEMA 13 | NEMA 3  | NEMA 3R | NEMA 4         | NEMA 4X | NEMA 6 | NEMA 6P |
|---|-------------|--------|--------|---------|---------|---------|---------|----------------|---------|--------|---------|
| Rating Type                                   |             | Indoor |        |         |         | Outdoor |         | Indoor/Outdoor |         |        |         |
| Protection Against:                           | Test Number |        |        |         |         |         |         |                |         |        |         |
| Incidental Contact                            | 6.2         | •      | •      | •       | •       | •       | •       | •              | •       | •      | •       |
| Falling Dirt                                  | 6.2         | •      | •      | •       | •       | •       | •       | •              | •       | •      | •       |
| Rust  | 6.8         | •      |        | •       | •       | •       | •       | •              | •       | •      | •       |
| Circulating Dust, Lint, Fibers (nonhazardous) | 6.5.1.2(2)  |        |        | •       | •       | •       |         | •              | •       | •      | •       |
| Windblown Dust                                | 6.5.1.1(2)  |        |        |         |         | •       |         | •              | •       | •      | •       |
| Falling Liquids/Light Splashing               | 6.3.2.2     |        | •      | •       | •       | •       |         | •              | •       | •      | •       |
| Rain  | 6.4.2.1     |        |        |         |         | •       | •       | •              | •       | •      | •       |
| Rain  | 6.4.2.2     |        |        |         |         | •       |         | •              | •       | •      | •       |
| Snow and Sleet                                | 6.6.2.2     |        |        |         |         | •       | •       | •              | •       | •      | •       |
| Hose Down and Splashing Water                 | 6.7         |        |        |         |         |         |         | •              | •       | •      | •       |
| Occasional Prolonged Submersion               | 6.11(2)     |        |        |         |         |         |         |                |         | •      | •       |
| Oil and Coolant Drip                          | 6.3.2.2     |        |        | •       | •       |         |         |                |         |        |         |
| Oil and Coolant, Spray/Splash                 | 6.12        |        |        |         | •       |         |         |                |         |        |         |
| Corrosive Agents                              | 6.9         |        |        |         |         | •       | •       |                | •       |        | •       |

We reserve the right to make technical alterations without prior notice.

Reference Section

## NEMA 250 Test Definitions

**6.2 Rod Entry Test** - a 1/2" diameter rod may not enter the enclosure and a 1/8" rod cannot enter within 4" of live components

**6.3 Drip Test** - 20 drops per minute for 30 minutes with no water entering enclosure 6.3.2.2 Evaluation, no water shall enter enclosure

**6.4 Rain Test** - All exposed surfaces are sprayed with 5 psi of water for 60 minutes at a rate of 18" per hour rise in a straight sided pan 6.4.2.1 Evaluation, No water shall have reached live parts, insulation, or mechanisms 6.4.2.2 Evaluation. No water shall have entered enclosure

**6.5.1.1 (2) Outdoor Dust Test (alternate method)** - Stream of water at 45 gallons per minute from a 1" diameter nozzle, from all directions at a distance from 10' to 12'. Test time is a minimum of 5 minutes. No water shall enter enclosure.

**6.5.1.2 (2) Indoor Dust Test (alternate method)** - Atomized water at 30 psi is sprayed from all directions from a distance of 12" to 15" at a rate of 3 gallons per hour. No water shall enter enclosure.

**6.6 External Icing Test** - The enclosure is sprayed with water between 0 °C and 3 °C in a room at 2 °C. The spray is between 1 and 2 gallons per hour per square foot. Spray for 1 hour. The room temp is then dropped to between -7 °C and -3 °C with the spray still going. Ice needs to build up on a test bar at a rate of 1/4 inch per hour. Spray continues until 3/4 inch of ice is on the enclosure. Room temperature is maintained for at least 3 hours. 6.6.2.2 Evaluation, enclosure is undamaged after ice has melted.

**6.7 Hose down Test** - Stream of water at 65 gallons per minute from a 1" diameter nozzle from all angles at a distance of 10' to 12'. Test time is 48 seconds times (height + width + depth of enclosure in feet) or a minimum of 5 seconds. No water shall enter enclosure.

**6.8 Rust Resistance Test** - only applicable to enclosures incorporating external ferrous parts

**6.9 Corrosion Protection** - Test per UL 508, 6.9 or 6.10.

**6.11 (2) Air Pressure Test (alternate method)** - Enclosure is submerged in water at a pressure equal to a depth of 6' for 24 hours. No water shall enter enclosure.

**6.12 Oil Exclusion Test** - Stream of test liquid at 2 gallons per minute from a 3/8" nozzle for 30 minutes. Water with 0.1% wetting agent is directed from all angles from a distance of 12" to 18". No test liquid shall enter the enclosure.

**Charts**

| Conversion Chart |               |                            |
|------------------|---------------|----------------------------|
| AWG to Metric    |               |                            |
| AWG              | Diameter (mm) | Section (mm <sup>2</sup> ) |
| 8                | 3.26          | 10                         |
| 10               | 2.59          | 6                          |
| 12               | 2.05          | 4                          |
| 14               | 1.63          | 2.5                        |
| 16               | 1.29          | 1.5                        |
| 18               | 1.024         | 0.75                       |
| 20               | 0.813         | 0.5                        |
| 22               | 0.643         | 0.34                       |
| 24               | 0.511         | 0.25                       |
| 26               | 0.405         | 0.14                       |
| 28               | 0.32          | 0.05                       |
| 30               | 0.255         | 0.05                       |

| Thread Conversion Chart |               |
|-------------------------|---------------|
| PG to Metric            |               |
| PG                      | Diameter (mm) |
| 7                       | 12            |
| 9                       | 16            |
| 11                      | 20            |
| 16                      | 25            |

| Cable Length Tolerance Chart |   |
|------------------------------|---|
| All Lengths                  | +4% or 50 mm, whichever is greater than -0 mm |
| Strip Length                 | Tolerance(mm)                                 |
| 0-7 mm                       | ±0.5 mm                                       |
| 8-29 mm                      | ±1.0 mm                                       |
| 30-49 mm                     | ±2.0 mm                                       |
| 50-69 mm                     | ±3.0 mm                                       |
| 70-100 mm                    | ±4.0 mm                                       |
| Over 100 mm                  | ±5.0 mm                                       |

We reserve the right to make technical alterations without prior notice.

Reference Section

### Installing Cable Products in Accordance with the National Electrical Code (NEC)

The NEC is a set of guidelines for installation of electrical devices, including cables, meant to reduce the risk of electrical shock, fire, etc. The NEC is simply a code, and local laws may or may not require installation based on the NEC. Check local laws for applicability.

The NEC generally does not cover cables installed inside a machine. Any cables installed in an exposed manner, on the outside of a machine or from one machine to something else, must be an approved type and installed in accordance with the appropriate NEC articles.

UL (Underwriters Laboratory) and CSA (Canadian Standards Association) are the primary sources in North America for approving cables to specific standards. While a cable installed within a piece of machinery does not fall under the NEC, most people want to install an approved cable. Turck cables have both UL and CSA approvals. Many of these approvals are the UL AWM (Appliance Wiring) approvals and are acceptable for use in a UL approved device. A UL Listed cable may be installed outside a machine per the NEC standards. UL Listed cables available from Turck include NEC designations for hard duty cables (SOOW, SJOOW, STOOW, SEOW), armored cables (MC), and tray-rated cables (PLTC, ITC).

Hard duty cables designations are:

- S- Service Grade (600 V)
- SJ - Service Grade Junior (300 V)
- ST - Service Grade Thermoplastic (600 V)
- SE - Service Grade Thermoplastic Elastomer (600 V)
- O - Oil resistant jacket material
- OO - Oil resistant jacket and conductor insulation
- W - Weather proof

Turck armored cables are available in 3 different configurations. Type MC cables, type MC cables with ITC/PLTC approvals and simply ITC/PLTC approved. Armored cables with ITC/PLTC approvals may be installed in an exposed run without being offered additional mechanical protection.

Tray-rated cables from Turck include Instrument Tray Cable (ITC) and/or Power Limited Tray Cable (PLTC) or Tray Cable-Exposed Run (TC-ER).

Turck NEC type approved cables are dual listed with other UL type approvals. For example, the RKM 126-\*M cordset has a 12 conductor 16 AWG cable with UL AWM 600 V approval and ITC/PLTC approval.

Please refer to the NEC and local laws for specific installation requirements based on your environment.

**Cable Applications**

Proper management of cabling systems can mean the difference between a dependable and smooth operating installation and costly reoccurring down time. The suggestions outlined below illustrate some of the common sources of problems and provide simple and effective solutions.

**RoHS (Restriction of Hazardous Substances in Electrical and Electronic Equipment)**

Providing sufficient bend radius will allow the cable to absorb the energy of bending over a greater portion of its length, increasing its effective working life. Small increases in the radius of the bend can produce substantial increases in cable life.

Minimum bend radius for fixed applications:  
 Standard cable - 5x cable diameter  
 Armorfast® cable - 12x cable diameter

Minimum bend radius for moving applications:  
 Standard cable - 10x cable diameter  
 Armorfast® cable - 15x cable diameter



**Eliminating Stress Points in Cable Dress**

Installing cables to allow for adequate stress loops and freedom of motion increase the life of the cables. Turck cordsets incorporate molded strain reliefs that will assist in preventing stress.

Tie Down Loops

Strain Relief

Correct

Incorrect

Correct

Incorrect

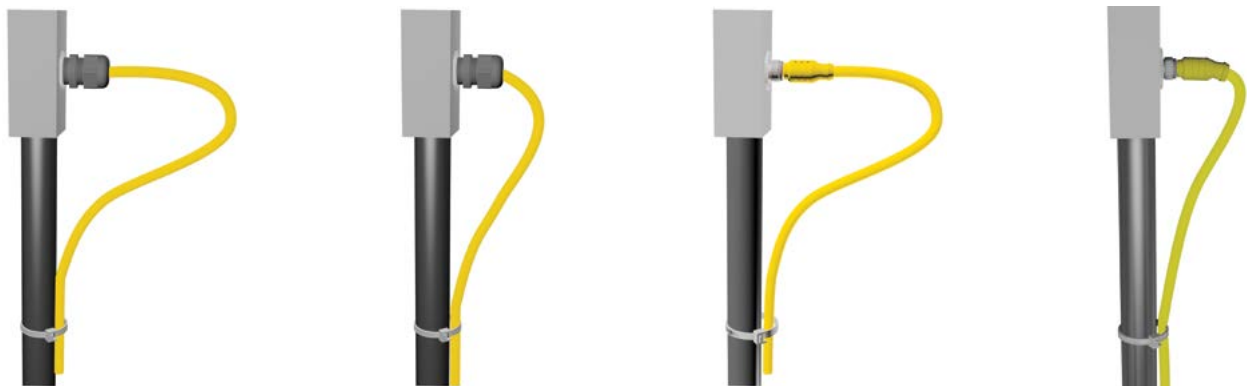

Reference Section

## Connectivity Products

### Cable Bundling Techniques

When bundling several cables together, always keep the bundle loose enough to move within itself. Tightly tied bundles create both compression and tension stresses when the bundle is moved.

Correct

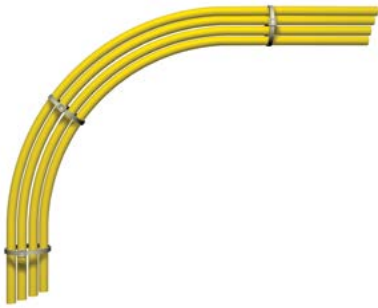

Incorrect



### Cabling for Motion Applications

Where cabling is subjected to linear, angular or rotational motion between two points, always allow adequate cable length to absorb the energy imparted by the motion. Use of coiled cords, mechanical support mechanisms, or large, well supported cable loops will maximize cable life.

Coil Cord

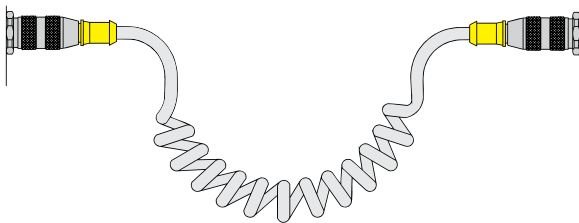

Cable Loop

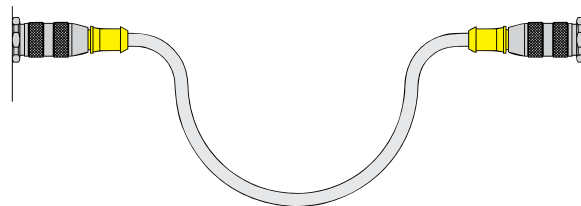



## Standard Cable Selection Guide

| Selection Criteria                           | PVC Flexlife®    | TPU Flexlife (S90) | CPE Rubber Flexlife (S600) | Weldlife (S1587)          | Flexlife-20° TPE (S101)   | Flexlife-20 TPU(S90/S101) |
|--|------------------|--------------------|----------------------------|---------------------------|---------------------------|---------------------------|
| <b>Ozone and UV resistance</b>               | Excellent        | Excellent          | Excellent                  | Excellent                 | Excellent                 | Excellent                 |
| <b>Temperatures</b>                          | -40 °C to 105 °C | -40 °C to 90 °C    | -50 °C to 105 °C           | -60 °C to 105 °C          | -60 °C to 105 °C          | -40 °C to 90 °C           |
| <b>Cold Bend test</b>                        | -40 °C           | -40 °C             | -55 °C                     | -60 °C                    | -60 °C                    | -40 °C                    |
| <b>Abrasion &amp; Cut-through resistance</b> | Fair             | Excellent          | Excellent                  | Good                      | Good                      | Excellent                 |
| <b>Flexing (# of cycles)</b>                 | 2 million        | 2 million          | 2 million                  | 2 million                 | 20 million+               | 20 million+               |
| <b>Burn resistance</b>                       | Good             | Excellent          | Excellent                  | Good                      | Good                      | Excellent                 |
| <b>Oxidation resistance</b>                  | Excellent        | Excellent          | Good                       | Excellent                 | Excellent                 | Excellent                 |
| <b>Water resistance</b>                      | Excellent        | Excellent          | Excellent                  | Excellent                 | Excellent                 | Excellent                 |
| <b>Cost</b>                                  | \$               | \$\$               | \$\$\$                     | \$\$                      | \$\$                      | \$\$                      |
| <b>Weld Slag resistance</b>                  | Poor             | Good               | Excellent                  | Excellent                 | Excellent                 | Good                      |
| <b>Flame Test</b>                            |                  |                    |                            |                           |                           |                           |
| <b>UL Test standards</b>                     | Horizontal       | Vertical Tray      | Horizontal                 | Horizontal/ Vertical Tray | Horizontal/ Vertical Tray | Vertical Tray             |
| <b>CSA Test standards</b>                    | FT1              | FT4                | FT1                        | FT1/FT4                   | FT1/FT4                   | FT4                       |
| <b>Chemical Resistance</b>                   |                  |                    |                            |                           |                           |                           |
| <b>Acids</b>                                 | Fair/Good        | Good               | Excellent                  | Good                      | Good                      | Good                      |
| <b>Alkalines</b>                             | Good             | Excellent          | Excellent                  | Excellent                 | Excellent                 | Excellent                 |
| <b>Alcohols</b>                              | Poor/Fair        | Poor/Fair          | Excellent                  | Excellent                 | Excellent                 | Poor/Fair                 |
| <b>Most Solvents</b>                         | Poor/Fair        | Poor               | Good                       | Poor                      | Poor                      | Poor                      |
| <b>Oils</b>                                  | Good             | Excellent          | Excellent                  | Good                      | Excellent                 | Excellent                 |
| <b>Gasoline</b>                              | Poor             | Poor               | Poor                       | Poor                      | Poor                      | Poor                      |
| <b>Greases</b>                               | Good             | Excellent          | Excellent                  | Poor                      | Poor                      | Excellent                 |
| <b>Available in Cordsets</b>                 |                  |                    |                            |                           |                           |                           |
| <b>Eurofast®</b>                             | X                | X                  | X                          | X                         | X                         |                           |
| <b>Picofast®</b>                             | X                | X                  |                            | X                         | X                         | X                         |
| <b>Minifast®</b>                             | X                | X                  | X                          | X                         | X                         |                           |
| <b>Microfast®</b>                            | X                | X                  | X                          | X                         |                           |                           |
| <b>Multifast®</b>                            | X                | X                  |                            | X                         | X                         | X                         |
| <b>V*fast®</b>                               | X                | X                  | X                          | X                         |                           |                           |

We reserve the right to make technical alterations without prior notice.

Reference Section

## Specialty Cable Selection Guide

| Selection Criteria                | Armorfast MC/ITC | † ITC/PLTC PVC   | † ITC/PLTC TPU   | ITC/PLTC ER/DB PVC | ITC/PLTC ER/DB TPE |
|-----------------------------------|------------------|------------------|------------------|--------------------|--------------------|
| Ozone and UV resistance           | Excellent        | Excellent        | Excellent        | Excellent          | Excellent          |
| Temperatures                      | -25 °C to 105 °C | -30 °C to 105 °C | -60 °C to 105 °C | -40 °C to 105 °C   | -60 °C to 105 °C   |
| Cold Bend test                    | -25 °C           | -30 °C           | -60 °C           | -40 °C             | -60 °C             |
| Abrasion & Cut-through resistance | Fair             | Fair             | Excellent        | Good               | Very Good          |
| Flexing (# of cycles)             | 2 million        | 2 million        | 2 million        | 2 million          | 2 million          |
| Burn resistance                   | Fair/Good        | Excellent        | Excellent        | Excellent          | Excellent          |
| Oxidation resistance              | Excellent        | Excellent        | Excellent        | Excellent          | Excellent          |
| Water resistance                  | Excellent        | Excellent        | Excellent        | Excellent          | Excellent          |
| Cost                              | \$               | \$               | \$\$             | \$\$               | \$\$               |
| Weld Slag resistance              | Poor             | Good             | Good             | Poor               | Excellent          |
| <b>Flame Test</b>                 |                  |                  |                  |                    |                    |
| UL Test standards                 | Vertical Tray    | Vertical Tray    | Vertical Tray    | Vertical Tray      | Vertical Tray      |
| CSA Test standards                | FT4              | FT4              | FT4              | FT4                | FT4                |
| IEC Test Standards                | 60332-3 Cat. A   | 60332-3 Cat. A   | 60332-3 Cat. A   |                    |                    |
| IEEE Test Standards               | 1202             | 1202             | 1202             | 1202               | 1202               |
| <b>Chemical Resistance</b>        |                  |                  |                  |                    |                    |
| Acids                             | Fair/Good        | Fair/Good        | Good             | Fair/Good          | Good               |
| Alkalines                         | Good             | Good             | Excellent        | Good               | Excellent          |
| Alcohols                          | Poor/Fair        | Poor/Fair        | Poor/Fair        | Poor/Fair          | Excellent          |
| Most Solvents                     | Poor/Fair        | Poor/Fair        | Poor             | Poor/Fair          | Poor               |
| Oils                              | Good             | Good             | Excellent        | Good               | Good               |
| Gasoline                          | Poor             | Poor             | Poor             | Poor               | Poor               |
| Greases                           | Good             | Good             | Excellent        | Good               | Poor               |
| <b>Available in Cordsets</b>      |                  |                  |                  |                    |                    |
| Eurofast®                         | X                | X                | X                | X                  | X                  |
| Picofast®                         |                  |                  | X                |                    |                    |
| Minifast®                         | X                | X                | X                | X                  | X                  |
| Microfast®                        |                  |                  | X                |                    |                    |
| Multifast®                        |                  | X                | X                | X                  |                    |
| V*fast®                           |                  |                  | X                |                    |                    |

We reserve the right to make technical alterations without prior notice.

## Tying Cables with Cable Ties

When tying cable with self locking cable ties, always leave the ties loose enough for the cables to slide freely under the tie. Over tightening will create stress concentrations that can cause the conductors to fail prematurely. Never tighten the tie to the point where the cable jacket becomes deformed or pinched.

Correct

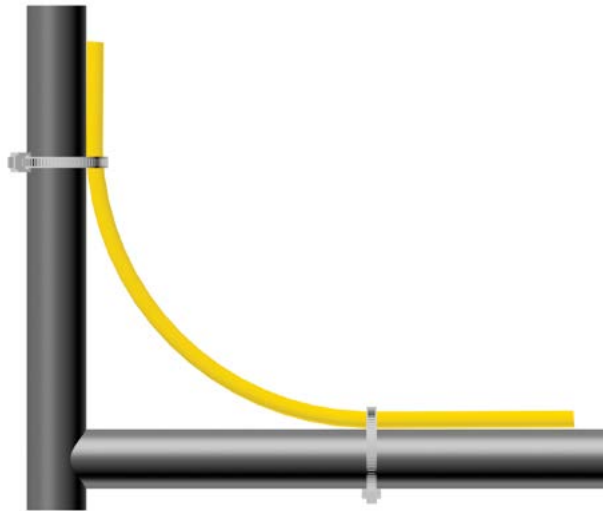

Incorrect

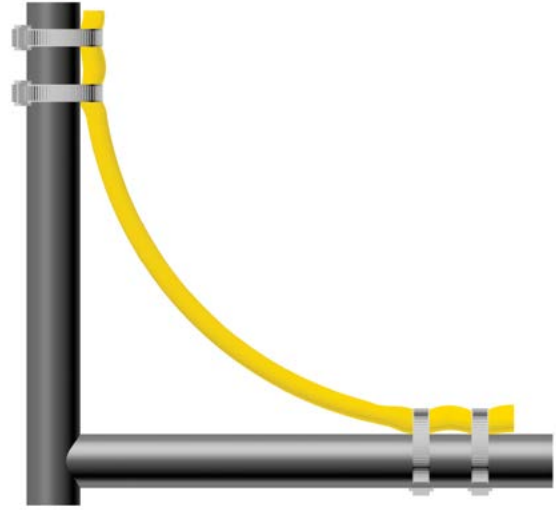

### **Abrasion Resistance**

Ability of wire, cable or material to resist surface wear.

### **AC Alternating Current**

Current in which the charge-flow periodically reverses and is represented by:  $I = I_0 \cos(2\pi f + \phi)$  [ $I = I_m \cos(\omega t + \phi)$ ] where  $I$  is the current,  $I_0$  is the amplitude,  $f$  is the frequency, and  $\phi$  is the phase angle.

### **Ambient Temperature**

The temperature of a medium (gas or liquid) surrounding an object.

### **Ampere (A)**

The unit of current. One ampere is the current flowing through one ohm of resistance at one volt potential.

### **ANSI**

Abbreviation for American National Standards Institute.

### **Armorfast®**

Cordset with metal clad cable (NEC type MC)

### **Armored Cable**

A cable provided with a wrapping of metal for mechanical protection.

### **AWG (American Wire Gauge)**

The standard system used for designating wire diameter. The lower the AWG number, the larger the diameter. Also called the Brown and Sharpe (B&S) wire gauge.

### **AWM (Appliance Wiring Material)**

A UL designation covering insulated wire and cable for internal wiring of appliances and equipment.

### **Binder**

A spirally served tape or thread used for holding assembled cable components in place awaiting subsequent manufacturing operations.

### **Braid**

A fibrous or metallic group of filaments interwoven in cylindrical form to form a covering over one or more wires.

### **Cable**

A stranded conductor with or without insulation and other coverings (single-conductor cable), or a combination of conductors (multiple-conductor cable).

### **Color Code**

Wire or circuit identification by color, utilizing solid colors, tracers, braids, surface printing, etc.

### **Contact Holder**

Insulating device that holds the contacts in their proper position

### **Conductivity**

The ability of a material to allow electrons to flow, measured by the current per unit of voltage applied. It is the reciprocal of resistivity.

### **Conductor**

A wire (or combination of wires not insulated from one another) suitable for carrying electric current.

### **Conduit**

A tube or trough in which insulated wires and cables are run.

### **Connector**

A device used to provide rapid connect / disconnect service for electrical cable and wire terminations.

### **Contact**

The parts of a connector that actually carry the electrical current and that are touched together or separated to control the flow.

### **Cable**

A multiconductor cable made for operation in control circuits.

### **Cordset**

Portable cord fitted with a wiring device at one or both ends.

### **Cord**

A small, flexible insulated cable.

### **CPE (Chlorinated Polyethylene)**

A flexible material with high tear strength and good resistance to most inorganic chemicals. It is inherently difficult to ignite. A Thermoset plastic.

### **Creepage**

The conduction of electricity across the surface of a dielectric.

### **Crimp Termination**

A connection in which a metal sleeve is secured to a conductor by mechanically crimping the sleeve with pliers, presses or automated crimping machines.

### **Current (I)**

The rate of transfer of electricity. Practical unit is the ampere, which represents the transfer of one coulomb per second. In a simple circuit, current ( $I$ ) produced by a cell or electromotive force ( $E$ ) when there is an external resistance and internal resistance is:

$$I = E / (R + r)$$

### **Current Carrying Capacity**

The maximum current an insulated conductor can safely carry without exceeding its insulation and jacket temperature limitations.

### **Cut-Through Resistance**

The ability of a material to withstand mechanical pressure, usually a sharp edge or small bending radius, without separation.

### **Dielectric Strength**

The voltage that an insulator can withstand before breakdown occurs. Usually expressed as a voltage gradient (such as volts per mil).

### **Direct Current (DC)**

An electric current that flows in only one direction.

### **Drain Wire**

In a cable, the bare wire laid over the component or components and used as a ground connection.

### **Earth**

British terminology for zero-reference ground.

### **Eurofast®**

M12 threads, single key, 2 - 6, 8, 10, 12 pin

### **Extruded Cable**

Cable with conductors that are uniformly insulated and formed by applying a homogeneous insulation material in a continuous extrusion process.

### **Fillers**

Non-conducting components cabled with the insulated conductors or optical fibers to impart roundness, flexibility, tensile strength, or a combination of all three, to the cable.

### **Firefast®**

High temperature protective sleeving.

### **Ground**

An electrical connection to the earth, generally through a ground rod. Also a common return to a point of zero potential, such as the metal chassis of equipment.

## Glossary of Terms

**Ground Loop**

A completed circuit between shielded pairs of a multiple pair created by random contact between shields. An undesirable circuit condition in which interference is created by ground currents when grounds are connected at more than one point.

**Ground Potential**

The potential of the earth. A circuit, terminal or chassis is said to be at ground potential when it is used as a reference point for other potentials in the system.

**Hygroscopic**

Capable of absorbing moisture from the air.

**IEC**

European Standardization agency; International Electrotechnical Commission.

**Input**

A signal (or power) which is applied to a piece of electrical apparatus or the terminals on the apparatus to which a signal or power is applied.

**Insulation**

A material having good dielectric properties that is used to separate close electrical components, such as cable conductors and circuit components.

**ITC**

Instrument Tray Cable. NEC classification for cable resistant to the spread of fire and suitable for use in cable trays. 150 V rating.

**Irradiation**

In insulation, the exposure of the material to high-energy emissions for the purpose of favorably altering the molecular structure.

**Jacket**

Pertaining to wire and cable, the outer protective covering, may also provide additional insulation.

**LED**

Light Emitting Diode used to indicate device status.

**Line Voltage**

The value of the potential existing on a supply or power line.

**Load**

A device that consumes power from a source and uses that power to perform a function.

**MC**

Metal Clad Cable. NEC classification for cable resistant to crush and impact based on an outer covering of metal.

**Microfast®**

½"-20 UNF threads, dual key, 2-6 pin

**Minifast®**

7/8"-16UN threads, 2 - 6 pin

**Minifast B size**

1"-16 UN threads, 6-8 pin

**Minifast C size**

1 1/8"-16 UN threads, 9, 10, 12 pin

**Moisture Resistance**

The ability of a material to resist absorbing moisture from the air or from water when immersed.

**Molded Plug**

A connector molded onto either end of a cord or cable.

**MOV**

Acronym for Metal Oxide Varistor. A solid state device used to suppress voltage surges \ spikes

**MSHA**

Mine Safety and Health Administration

**Multibox®**

Junction boxes, 4, 6, 8 and 16 port

**Multifast®**

M23 threads, 12, 16 and 19 pin or M27 threads, 26 and 28 pin

**Mylar**

DuPont trademark for polyester film.

**National Electrical Code (NEC)**

A set of regulations governing construction and installation of electrical wiring and apparatus in the United States, established by the American National Board of Fire Underwriters.

**NEMA**

National Electrical Manufacturers Association.

**Neoprene**

A synthetic rubber with good resistance to oil, chemical, and flame. Also called polychloroprene. A Thermoset plastic.

**Noise**

In a cable or circuit, any extraneous signal that tends to interfere with the signal normally present in or passing through the system.

**NPN Output**

Transistor output that switches the common or negative voltage to the load (current sinking). Load connected between output and positive supply.

**Ohm (Ω)**

The electrical unit of resistance. The value of resistance through which a potential difference of one volt will maintain a current of one ampere.

**Ohm's Law**

$E = I \times R$ . Voltage (E) is directly proportional to the product of current (I) and resistance of circuit.

**Output**

The useful power or signal delivered by a circuit or device.

**PA (Polyamide, Nylon)**

An abrasion-resistant thermoplastic with good chemical resistance, also known as polyamide.

**Pentafast®**

M5 threads, 3 and 4 pin

**Picofast®**

Snap lock or M8 threads, 3, 4 and 6 pin

**Plastic**

High-polymeric substances, including both natural and synthetic products, but excluding the rubbers, that are capable of flowing under heat and pressure.

**Plug**

A connector associated with being attached to a cable.

**PLTC**

Power Limited Tray Cable. NEC classification for cable resistant to the spread of fire and suitable for use in cable trays. 300 V rating.

**PNP Output**

Transistor output that switches the positive voltage to the load (current sourcing). Load connected between output and common.

**POM (Polyoxymethylene, Acetal, Delrin )**

Polyoxymethylene - a crystalline thermoplastic polymer with a high melting point. It is suitable for mechanical parts or electrical insulators that require structural strength at above normal temperatures.

**Potting**

The sealing of a cable termination or other component with a liquid that thermosets into an elastomer.

**PUR (Polyurethane)**

Broad class of polymers noted for good abrasion and solvent resistance.

**PVC (Polyvinyl Chloride)**

A general-purpose thermoplastic widely used for wire and cable insulation and jackets.

**Powerfast**

1 3/8"-16 threads, 2, 3 and 4 pin or M23 threads, 6, 7 and 9 pins or M40 threads, 4-pin.

**Resistance**

A measure of the difficulty in moving electrical current through a medium when voltage is applied. It is measured in ohms.

**Retractable Cord**

A cord having a specially treated jacket or insulation so that it will retract like a spring. Retractility may be added to all or part of a cord's length.

**RoHS**

(Restriction of Hazardous Substances).

**Rubber**

A general term used to describe wire insulation made of thermosetting elastomers, such as natural or synthetic rubbers, neoprene, Hypalon, CPE butyl rubber and others.

**Shield**

In cables, a metallic layer placed around a conductor or group of conductors to prevent electrostatic or electromagnetic interference between the enclosed wires and external fields.

**Signal**

Any visible or audible indication that can convey information. Also, the information conveyed through a communication system.

**SJOOW**

Junior hard service, rubber insulated, portable cord with oil resistant rubber outer jacket. Stranded copper conductors with separator and individual oil and water resistant rubber insulation. Two or more color coded conductors cabled with filler, wrapped with separator and rubber jacketed overall. 300 V.

**Solid Conductor**

A conductor consisting of a single wire.

**Solid State**

Pertains to circuits and components using semiconductors without moving parts. Example: transistors, diodes, SCR, etc.

**SOOW**

Heavy duty, rubber-insulated portable cord with oil resistant rubber outer jacket. Stranded copper conductors with separator and individual oil and rubber insulation. Two or more color-coded conductors cabled with filler, wrapped with separator and rubber jacketed overall. 600 V.

**STOW**

Heavy duty, PVC insulated, portable cord with oil resistant PVC outer jacket. Stranded copper conductors, PVC insulation. Two or more color coded conductors cabled with filler, wrapped with separator and PVC jacketed overall. Approved for outdoor use. 600 V.

**Stranded Conductor**

A conductor composed of groups of wires twisted together.

**Temperature Rating**

The maximum temperature at which a material may be used in continuous operation without loss of its basic properties.

**Thermoplastic**

A material that will soften, flow or distort appreciably when subjected to heat and pressure.

**Thermoset**

A material that hardens or sets when heat is applied, and which, once set, cannot be re-softened by heating. The application of heat is called "curing".

**TPE**

Thermo Plastic Elastomer. Broad class of polymers noted for flexibility and weld slag resistance.

**TPR**

Thermo Plastic Rubber. Another name for TPE.

**Twisted Pairs**

A cable composed of two small, insulated conductors twisted together without a common covering.

**Versafast™**

M16 threads, 5, 6, 7, 8, 12, 14 and 19 pin

**V\*fast®**

DIN 43650, type A, B, I and C

**VDE**

German approval agency.

**Volt (V)**

A unit of electrical pressure. One volt is the electrical pressure that will cause one ampere of current to flow through one ohm of resistance.

**Voltage**

The term most often used in place of electromotive force, potential difference, or voltage drop. Designates the electric pressure existing between two points that is capable of producing a current when a closed circuit is connected between these points.

**Voltage Rating**

The highest voltage that may be continuously applied to a wire in conformance with standards or specifications.

**VW-1**

A flammability rating established by Underwriters Laboratories for wires and cables that pass a specially designed vertical flame test, formerly designated FR-1.

**Wicking**

The longitudinal flow of a liquid in a wire or cable due to capillary action.







## Index

|                     |     |                    |     |                    |     |
|---------------------|-----|--------------------|-----|--------------------|-----|
|                     | #   | 4MBM12-5P3-*C      | S4  | 8MB12-5P3-*B       | S26 |
|                     |     | 4MBM12-5P3-BS14    | S4  | 8MB12-5P3-*BL      | S26 |
| 16MB12-4P2-CS19     | S40 | 4MBMV12-4-*C       | S4  | 8MB12-5P4-K-FK     | S34 |
| 4 RKF 30-*M         | S54 | 4MBMV12-4N2-*C     | S4  | 8MB12-5P4-K-SK     | S34 |
| 4 RKF 30-B1161      | S54 | 4MBMV12-4P2-*C     | S4  | 8MB12Z-4-*         | S16 |
| 4 RKF 30-CS12       | S54 | 4MBMV12-5-*C       | S4  | 8MB12Z-4-*RSM120   | S18 |
| 4 RKF 30-X5-*M      | S58 | 4MBMV12-5N3-*C     | S4  | 8MB12Z-4-CS12      | S16 |
| 4 RKF 30-X5-CS12    | S58 | 4MBMV12-5P3-*C     | S4  | 8MB12Z-4-CS12H     | S16 |
| 4 RKF 30-X5-RSF70   | S60 | 4MBV12-4P2-*       | S22 | 8MB12Z-4-RSF120    | S18 |
| 4 RKF 301-*M        | S66 | 4MBV12-4P2-CSV12   | S22 | 8MB12Z-4N2-*       | S16 |
| 4 RKF 301-B1131     | S66 | 4MBV12-5P3-*       | S22 | 8MB12Z-4N2-*RSM120 | S18 |
| 4 RKF 40-*M         | S62 | 4MBV12-5P3-CSV19   | S22 | 8MB12Z-4N2-CS12    | S16 |
| 4 RKF 40-RSF6B6     | S64 | 6 RKF 30-*M        | S54 | 8MB12Z-4N2-CS12H   | S16 |
| 4MB12-5P1-MS-SK     | S32 | 6 RKF 30-CS12      | S54 | 8MB12Z-4N2-RSF120  | S18 |
| 4MB12-5P4-K-FK      | S32 | 6 RKF 30-RSF80     | S56 | 8MB12Z-4P2-*       | S16 |
| 4MB12-5P4-K-SK      | S32 | 6 RKF 301-*M       | S66 | 8MB12Z-4P2-*RSM120 | S18 |
| 4MB12Z-4-*          | S6  | 6 RKF 301-B1131    | S66 | 8MB12Z-4P2-CS12    | S16 |
| 4MB12Z-4-*RSM 120   | S8  | 6 RKF 40-*M        | S62 | 8MB12Z-4P2-CS12H   | S16 |
| 4MB12Z-4-CS12       | S6  | 6 RKF 40-RSF80     | S64 | 8MB12Z-4P2-RSF120  | S18 |
| 4MB12Z-4-CS12H      | S6  | 6MB12Z-4-*         | S12 | 8MB12Z-5-*         | S20 |
| 4MB12Z-4-RSF120     | S8  | 6MB12Z-4-CS12      | S12 | 8MB12Z-5-CS19      | S20 |
| 4MB12Z-4N2-*        | S6  | 6MB12Z-4-CS12H     | S12 | 8MB12Z-5-CS19H     | S20 |
| 4MB12Z-4N2-*RSM 120 | S8  | 6MB12Z-4N2-*       | S12 | 8MB12Z-5N3-*       | S20 |
| 4MB12Z-4N2-CS12     | S6  | 6MB12Z-4N2-CS12    | S12 | 8MB12Z-5N3-CS19    | S20 |
| 4MB12Z-4N2-CS12H    | S6  | 6MB12Z-4N2-CS12H   | S12 | 8MB12Z-5N3-CS19H   | S20 |
| 4MB12Z-4P2-*        | S6  | 6MB12Z-4P2-*       | S12 | 8MB12Z-5P3-*       | S20 |
| 4MB12Z-4P2-*RSM 120 | S8  | 6MB12Z-4P2-CS12    | S12 | 8MB12Z-5P3-CS19    | S20 |
| 4MB12Z-4P2-CS12     | S6  | 6MB12Z-4P2-CS12H   | S12 | 8MB12Z-5P3-CS19H   | S20 |
| 4MB12Z-4P2-CS12H    | S6  | 6MB12Z-5-*         | S14 | 8MBV12-4P2-*       | S24 |
| 4MB12Z-4P2-RSF120   | S8  | 6MB12Z-5-CS19      | S14 | 8MBV12-4P2-CSV12   | S24 |
| 4MB12Z-5-*          | S10 | 6MB12Z-5-CS19H     | S14 | 8MBV12-5P3-*       | S24 |
| 4MB12Z-5-CS19       | S10 | 6MB12Z-5N3-*       | S14 | 8MBV12-5P3-*B      | S26 |
| 4MB12Z-5-CS19H      | S10 | 6MB12Z-5N3-CS19    | S14 | 8MBV12-5P3-*BL     | S26 |
| 4MB12Z-5N3-*        | S10 | 6MB12Z-5N3-CS19H   | S14 | 8MBV12-5P3-CSV19   | S24 |
| 4MB12Z-5N3-CS19     | S10 | 6MB12Z-5P3-*       | S14 |                    |     |
| 4MB12Z-5N3-CS19H    | S10 | 6MB12Z-5P3-CS19    | S14 |                    |     |
| 4MB12Z-5P3-*        | S10 | 6MB12Z-5P3-CS19H   | S14 |                    |     |
| 4MB12Z-5P3-CS19     | S10 | 8 RKF 30-*M        | S54 | ASI-PM-1 BW1239    | R14 |
| 4MB12Z-5P3-CS19H    | S10 | 8 RKF 30-CS12      | S54 |                    |     |
| 4MBM12-4-*C         | S4  | 8 RKF 30-RSF100    | S56 |                    |     |
| 4MBM12-4-FS 8       | S4  | 8 RKF 30-X9-*M     | S58 |                    |     |
| 4MBM12-4N2-*C       | S4  | 8 RKF 30-X9-CS12   | S58 | B 4131-0/13.5      | F48 |
| 4MBM12-4N2-FS8      | S4  | 8 RKF 30-X9-RSF120 | S60 | B 4131-0/9         | F48 |
| 4MBM12-4P2-*C       | S4  | 8 RKF 301-*M       | S66 | B 4141-0/13.5      | F48 |
| 4MBM12-4P2-FS 8     | S4  | 8 RKF 301-B1131    | S66 | B 4141-0/9         | F48 |
| 4MBM12-5-*C         | S4  | 8 RKF 40-*M        | S62 | B 4151-0/13.5      | F48 |
| 4MBM12-5-BS14       | S4  | 8 RKF 40-RSF100    | S64 | B 4151-0/13.5/DNET | M44 |
| 4MBM12-5N3-*C       | S4  | 8MB12-5P1-MS-FK    | S34 | B 4151-0/16        | F48 |
| 4MBM12-5N3-BS14     | S4  | 8MB12-5P1-MS-SK    | S34 | B 4151-0/16/DNET   | M44 |

**A**

**B**

Index

# Connectivity Products

## Index

|                    |          |                                 |          |                        |     |
|--------------------|----------|---------------------------------|----------|------------------------|-----|
| B 4151-0/9         | F48      | B3131-PG9-*                     | E17      | BKF 12                 | G26 |
| B 4151-0/9/DNET    | M44      | B3141-*                         | E17      | BKF 12-12-*            | G11 |
| B 4231-0/9         | F48      | B3141-PG9-*                     | E17      | BKF 12-12-*/14.5/NPT   | G17 |
| B 4241-0/9         | F48      | B3151-*                         | E17      | BKF 12-12-*/18.375/NPT | G19 |
| B 4251-0/9         | F48      | B3151-PG9-*                     | E17      | BKF 12-12-*/M18        | G13 |
| B 4251-0/9/DNET    | M44      | B50783-*M                       | N6       | BKF 12-12-*/M20        | G15 |
| B 5131-0           | C24      | BCA-49-E123                     | N22, R22 | BKF 14                 | G26 |
| B 5133-0           | C24      | BCA-49-E223                     | N22, R22 | BKF 14-10-*            | G11 |
| B 5136-0           | C26      | BCA-49-M123                     | N22, R22 | BKF 14-10-*/14.5/NPT   | G17 |
| B 5141-0           | C24      | BCA-49-M223                     | N22      | BKF 14-10-*/18.375/NPT | G19 |
| B 5143-0           | C24      | BCA-49SC-M123                   | N22, R22 | BKF 14-10-*/M18        | G13 |
| B 5146-0           | C26      | BCA-49SC-M223                   | N22, R22 | BKF 14-10-*/M20        | G15 |
| B 5231-0           | C25      | BCA-57-E123                     | M48      | BKF 14-12-*            | G11 |
| B 5241-0           | C25      | BCA-57-E223                     | M48      | BKF 14-12-*/14.5/NPT   | G17 |
| B 716B61-0/21      | F49, F50 | BCA-57-M123                     | M48      | BKF 14-12-*/18.375/NPT | G19 |
| B 7171-0/21        | F49, F50 | BCA-57-M223                     | M48      | BKF 14-12-*/M18        | G13 |
| B 7181-0/21        | F49, F50 | BCA1-F7-57-M123                 | M48      | BKF 14-12-*/M20        | G15 |
| B 81121-0/PG 9     | D84      | BCA1-F7-57-M223                 | M48      | BKF 14-14-*            | G11 |
| B 8141-0           | D83      | BH-BKM/BSM/2BK M 22             | J35      | BKF 14-14-*/14.5/NPT   | G17 |
| B 8141-0/LABEL     | D85      | BH-BKM/BSM/2BK M 22-380-*       | J35      | BKF 14-14-*/18.375/NPT | G19 |
| B 8141-0/PG 9      | D83, P34 | BH-BKM/BSM/2BK M 22-380-*/*/*/* | J35      | BKF 14-14-*/M18        | G13 |
| B 8141-0/PG9/ASI   | R20      | BH-BKM/BSM/2BK M 34             | J35      | BKF 14-14-*/M20        | G15 |
| B 8141-0/PG9/LABEL | D85      | BH-BKM/BSM/2BK M 34-198-*       | J35      | BKF 19                 | G26 |
| B 8141-P7X2-0      | D86      | BH-BKM/BSM/2BK M 34-198-*/*/*/* | J35      | BKF 19-19-*            | G11 |
| B 8146-0           | D87      | BH-BKM/BSM/2BK M 44             | J35      | BKF 19-19-*/14.5/NPT   | G17 |
| B 8151-0/PG 9      | D83      | BH-BKM/BSM/2BK M 44-193-*       | J35      | BKF 19-19-*/18.375/NPT | G19 |
| B 8151-0/PG9/DNET  | M45      | BH-BKM/BSM/2BK M 44-193-*/*/*/* | J35      | BKF 19-19-*/M18        | G13 |
| B 8151-0/PG9/LABEL | D85      | BH-BSM/3BK M 22                 | J35      | BKF 19-19-*/M20        | G15 |
| B 8181-0           | D84      | BH-BSM/3BK M 22-380-*           | J35      | BKF 22-*/14.5/NPT      | J31 |
| B 8241-0           | D83      | BH-BSM/3BK M 22-380-*/*/*/*     | J35      | BKF 22-*/18.375/NPT    | J31 |
| B 8241-0/LABEL     | D85      | BH-BSM/3BK M 34                 | J35      | BKF 22-*/M18           | J31 |
| B 8241-0/PG 9      | D83, P34 | BH-BSM/3BK M 34-198-*           | J35      | BKF 22-*/M20           | J31 |
| B 8241-0/PG9/ASI   | R20      | BH-BSM/3BK M 34-198-*/*/*/*     | J35      | BKF 34-*/14.5/NPT      | J31 |
| B 8241-0/PG9/LABEL | D85      | BH-BSM/3BK M 44                 | J35      | BKF 34-*/18.375/NPT    | J31 |
| B 8246-0           | D87      | BH-BSM/3BK M 44-193-*           | J35      | BKF 34-*/M18           | J31 |
| B 8251-0/PG 9      | D83      | BH-BSM/3BK M 44-193-*/*/*/*     | J35      | BKF 34-*/M20           | J31 |
| B 8251-0/PG9/DNET  | M45      | BK 12-0                         | G28      | BKF 44-*/14.5/NPT      | J31 |
| B 8251-0/PG9/LABEL | D85      | BK 14-0                         | G29      | BKF 44-*/18.375/NPT    | J31 |
| B 8281-0           | D84      | BK 19-0                         | G29      | BKF 44-*/M18           | J31 |
| B 8346-0           | D87      | BK 22-0                         | J31      | BKF 44-*/M20           | J31 |
| B1131-*M           | F58      | BK 34-0                         | J31      | BKF 5-5-*              | G10 |
| B1131-PG9-*M       | F58      | BK 4140-0/9                     | P33      | BKF 5-5-*/14.5/NPT     | G16 |
| B1141-*M           | F58      | BK 4140-0/9/ASI                 | R19      | BKF 5-5-*/18.375/NPT   | G18 |
| B1141-PG9-*M       | F58      | BK 44-0                         | J31      | BKF 5-5-*/M18          | G12 |
| B1151-PG9-*M       | F58      | BK 5-0                          | G27      | BKF 5-5-*/M20          | G14 |
| B2131-*M           | F58      | BK 6-0                          | G27      | BKF 6-6-*              | G10 |
| B2131-*M/S523      | F58      | BK 7-0                          | G27      | BKF 6-6-*/14.5/NPT     | G16 |
| B2141-*M           | F58      | BK 8-0                          | G27      | BKF 6-6-*/18.375/NPT   | G18 |
| B3131-*            | E17      | BK52C 57x-*M                    | M14      | BKF 6-6-*/M18          | G12 |

## Index

|                      |          |                     |          |                     |          |
|----------------------|----------|---------------------|----------|---------------------|----------|
| BKF 6-6-*/M20        | G14      | BKM 14-002-*        | G6       | BKWMS 44-1363-*     | J30      |
| BKF 7-7-*            | G10      | BKM 14-755-*        | G6       | BM 8151-0/PG 9      | D83      |
| BKF 7-7-*/14.5/NPT   | G16      | BKM 14-836-*        | G7       | BMSWS 8151-0/9      | D89      |
| BKF 7-7-*/18.375/NPT | G18      | BKM 14-917-*        | G7       | BMSWS 8151-8.5/PDP  | P17      |
| BKF 7-7-*/M18        | G12      | BKM 14-954-*/S101   | G7       | BMSWS 8251-0/9      | D89      |
| BKF 7-7-*/M20        | G14      | BKM 14-998-*        | G6       | BMSWS 8251-8.5/PDP  | P17      |
| BKF 8-8-*            | G10      | BKM 19-873-*        | G8       | BMWS 8151-0/9       | D89      |
| BKF 8-8-*/14.5/NPT   | G16      | BKM 19-995-*        | G8       | BMWS 8151-8.5/PDP   | P17      |
| BKF 8-8-*/18.375/NPT | G18      | BKM 19-996-*/S90    | G8       | BMWS 8251-0/9       | D89      |
| BKF 8-8-*/M18        | G12      | BKM 22-380-*        | J30      | BMWS 8251-8.5/PDP   | P17      |
| BKF 8-8-*/M20        | G14      | BKM 34-198-*        | J30      | BPA-49-M113         | N22      |
| BKF-CC               | G30, J42 | BKM 44-193-*        | J30      | BS 12-0             | G28      |
| BKFD 12              | G26      | BKM 5-084-*         | G4       | BS 14-0             | G29      |
| BKFD 12-12-*         | G21      | BKM 6-085-*         | G4       | BS 19-0             | G29      |
| BKFD 12-12-*/M18     | G23      | BKM 7-086-*         | G4       | BS 22-0             | J31      |
| BKFD 12-PCB          | G25      | BKM 8-087-*         | G4       | BS 34-0             | J31      |
| BKFD 14              | G26      | BKM-CC              | G30, J42 | BS 4131-0/13.5      | F48      |
| BKFD 14-10-*         | G21      | BKM-MC              | G30, J42 | BS 4131-0/9         | F48      |
| BKFD 14-10-*/M18     | G23      | BKMS 22-1759-*      | J30      | BS 4140-0/9         | P33      |
| BKFD 14-12-*         | G21      | BKMS 34-1364-*      | J30      | BS 4140-0/9/ASI     | R19      |
| BKFD 14-12-*/M18     | G23      | BKMS 44-1363-*      | J30      | BS 4141-0/13.5      | F48      |
| BKFD 14-14-*         | G21      | BKS 12-0            | G28      | BS 4141-0/9         | F48      |
| BKFD 14-14-*/M18     | G23      | BKV 4140-0/11/FF    | N21      | BS 4151-0/13.5      | F48      |
| BKFD 14-PCB          | G25      | BKV 4140-0/16       | P33      | BS 4151-0/13.5/DNET | M44      |
| BKFD 19              | G26      | BKV 4140-0/16/FF    | N21      | BS 4151-0/16        | F48      |
| BKFD 19-19-*         | G21      | BKV 4140-0/9        | P33      | BS 4151-0/16/DNET   | M44      |
| BKFD 19-19-*/M18     | G23      | BKV 4140-0/9/ASI    | R19      | BS 4151-0/9         | F48      |
| BKFD 19-PCB          | G25      | BKWWM 12-001-*      | G5       | BS 4151-0/9/DNET    | M44      |
| BKFD 22-*/M18        | J31      | BKWWM 12-967-*      | G5       | BS 4231-0/9         | F48      |
| BKFD 34-*/M18        | J31      | BKWWM 12-999-*/S101 | G5       | BS 4241-0/9         | F48      |
| BKFD 44-*/M18        | J31      | BKWWM 14-000-*/S101 | G6       | BS 4251-0/9         | F48      |
| BKFD 5-5-*           | G20      | BKWWM 14-002-*      | G6       | BS 4251-0/9/DNET    | M44      |
| BKFD 5-5-*/M18       | G22      | BKWWM 14-755-*      | G6       | BS 44-0             | J31      |
| BKFD 5-PCB           | G24      | BKWWM 14-836-*      | G7       | BS 5-0              | G27      |
| BKFD 6-6-*           | G20      | BKWWM 14-917-*      | G7       | BS 5131-0           | C24      |
| BKFD 6-6-*/M18       | G22      | BKWWM 14-954-*/S101 | G7       | BS 5132-0           | C25      |
| BKFD 6-PCB           | G24      | BKWWM 14-998-*      | G6       | BS 5133-0           | C24      |
| BKFD 7-7-*           | G20      | BKWWM 19-873-*      | G8       | BS 5136-0           | C26      |
| BKFD 7-7-*/M18       | G22      | BKWWM 19-995-*      | G8       | BS 5141-0           | C24      |
| BKFD 7-PCB           | G24      | BKWWM 19-996-*/S90  | G8       | BS 5142-0           | C25      |
| BKFD 8-8-*           | G20      | BKWWM 22-380-*      | J30      | BS 5143-0           | C24      |
| BKFD 8-8-*/M18       | G22      | BKWWM 34-198-*      | J30      | BS 5146-0           | C26      |
| BKFD 8-PCB           | G24      | BKWWM 44-193-*      | J30      | BS 5231-0           | C25      |
| BKFK-CC              | G30      | BKWWM 5-084-*       | G4       | BS 5241-0           | C25      |
| BKK-CC               | G30      | BKWWM 6-085-*       | G4       | BS 6-0              | G27      |
| BKM 12-001-*         | G5       | BKWWM 7-086-*       | G4       | BS 7-0              | G27      |
| BKM 12-967-*         | G5       | BKWWM 8-087-*       | G4       | BS 716B61-0/21      | F49, F50 |
| BKM 12-999-*/S101    | G5       | BKWMS 22-1759-*     | J30      | BS 7171-0/21        | F49, F50 |
| BKM 14-000-*/S101    | G6       | BKWMS 34-1364-*     | J30      | BS 7181-0/21        | F49, F50 |

# Connectivity Products

## Index

|                        |          |                        |     |                       |          |
|------------------------|----------|------------------------|-----|-----------------------|----------|
| BS 8-0                 | G27      | BSF 19-19-*/14.5/NPT   | G17 | BSFD 19               | G26      |
| BS 81121-0/PG 9        | D84      | BSF 19-19-*/18.375/NPT | G19 | BSFD 19-19-*          | G21      |
| BS 8141-0              | D83      | BSF 19-19-*/M18        | G13 | BSFD 19-19-*/M18      | G23      |
| BS 8141-0/LABEL        | D85      | BSF 19-19-*/M20        | G15 | BSFD 19-PCB           | G25      |
| BS 8141-0/PG 9         | D83, P34 | BSF 22-*/14.5/NPT      | J31 | BSFD 22-*/M18         | J31      |
| BS 8141-0/PG9/ASI      | R20      | BSF 22-*/18.375/NPT    | J31 | BSFD 34-*/M18         | J31      |
| BS 8141-0/PG9/LABEL    | D85      | BSF 22-*/M18           | J31 | BSFD 44-*/M18         | J31      |
| BS 8141-P7X2-0         | D86      | BSF 22-*/M20           | J31 | BSFD 5-5-*            | G20      |
| BS 8146-0              | D87      | BSF 34-*/14.5/NPT      | J31 | BSFD 5-5-*/M18        | G22      |
| BS 8151-0/PG 9         | D83      | BSF 34-*/18.375/NPT    | J31 | BSFD 5-PCB            | G24      |
| BS 8151-0/PG9/DNET     | M45      | BSF 34-*/M18           | J31 | BSFD 6-6-*            | G20      |
| BS 8151-0/PG9/LABEL    | D85      | BSF 34-*/M20           | J31 | BSFD 6-6-*/M18        | G22      |
| BS 8157-0/PG 9         | D84      | BSF 44-*/14.5/NPT      | J31 | BSFD 6-PCB            | G24      |
| BS 8181-0              | D84      | BSF 44-*/18.375/NPT    | J31 | BSFD 7-7-*            | G20      |
| BS 8241-0              | D83      | BSF 44-*/M18           | J31 | BSFD 7-7-*/M18        | G22      |
| BS 8241-0/LABEL        | D85      | BSF 44-*/M20           | J31 | BSFD 7-PCB            | G24      |
| BS 8241-0/PG 9         | D83, P34 | BSF 5-5-*              | G10 | BSFD 8-8-*            | G20      |
| BS 8241-0/PG9/ASI      | R20      | BSF 5-5-*/14.5/NPT     | G16 | BSFD 8-8-*/M18        | G22      |
| BS 8241-0/PG9/LABEL    | D85      | BSF 5-5-*/18.375/NPT   | G18 | BSFD 8-PCB            | G24      |
| BS 8246-0              | D87      | BSF 5-5-*/M18          | G12 | BSFK-CC               | G30      |
| BS 8251-0/PG 9         | D83      | BSF 5-5-*/M20          | G14 | BSK-CC                | G30, J42 |
| BS 8251-0/PG9/DNET     | M45      | BSF 6-6-*              | G10 | BSM 12-001-*          | G5       |
| BS 8251-0/PG9/LABEL    | D85      | BSF 6-6-*/14.5/NPT     | G16 | BSM 12-967-*          | G5       |
| BS 8281-0              | D84      | BSF 6-6-*/18.375/NPT   | G18 | BSM 12-999-*/S101     | G5       |
| BS 8346-0              | D87      | BSF 6-6-*/M18          | G12 | BSM 14-000-*/S101     | G6       |
| BSF 12                 | G26      | BSF 6-6-*/M20          | G14 | BSM 14-002-*          | G6       |
| BSF 12-12-*            | G11      | BSF 7-7-*              | G10 | BSM 14-755-*          | G6       |
| BSF 12-12-*/14.5/NPT   | G17      | BSF 7-7-*/14.5/NPT     | G16 | BSM 14-836-*          | G7       |
| BSF 12-12-*/18.375/NPT | G19      | BSF 7-7-*/18.375/NPT   | G18 | BSM 14-917-*          | G7       |
| BSF 12-12-*/M18        | G13      | BSF 7-7-*/M18          | G12 | BSM 14-954-*/S101     | G7       |
| BSF 12-12-*/M20        | G15      | BSF 7-7-*/M20          | G14 | BSM 14-998-*          | G6       |
| BSF 14                 | G26      | BSF 8-8-*              | G10 | BSM 19-873-*          | G8       |
| BSF 14-10-*            | G11      | BSF 8-8-*/14.5/NPT     | G16 | BSM 19-995-*          | G8       |
| BSF 14-10-*/14.5/NPT   | G17      | BSF 8-8-*/18.375/NPT   | G18 | BSM 19-996-*/S90      | G8       |
| BSF 14-10-*/18.375/NPT | G19      | BSF 8-8-*/M18          | G12 | BSM 22-380-*          | J30      |
| BSF 14-10-*/M18        | G13      | BSF 8-8-*/M20          | G14 | BSM 34-198-*          | J30      |
| BSF 14-10-*/M20        | G15      | BSF-CC                 | G30 | BSM 44-193-*          | J30      |
| BSF 14-12-*            | G11      | BSFD 12                | G26 | BSM 5-084-*           | G4       |
| BSF 14-12-*/14.5/NPT   | G17      | BSFD 12-12-*           | G21 | BSM 6-085-*           | G4       |
| BSF 14-12-*/18.375/NPT | G19      | BSFD 12-12-*/M18       | G23 | BSM 7-086-*           | G4       |
| BSF 14-12-*/M18        | G13      | BSFD 12-PCB            | G25 | BSM 8-087-*           | G4       |
| BSF 14-12-*/M20        | G15      | BSFD 14                | G26 | BSM-CC                | G30, J42 |
| BSF 14-14-*            | G11      | BSFD 14-10-*           | G21 | BSM-MC                | G30, J42 |
| BSF 14-14-*/14.5/NPT   | G17      | BSFD 14-10-*/M18       | G23 | BSM/2BKM 22           | J34      |
| BSF 14-14-*/18.375/NPT | G19      | BSFD 14-12-*           | G21 | BSM/2BKM 22-380-*     | J34      |
| BSF 14-14-*/M18        | G13      | BSFD 14-12-*/M18       | G23 | BSM/2BKM 22-380-*/*/* | J34      |
| BSF 14-14-*/M20        | G15      | BSFD 14-14-*           | G21 | BSM/2BKM 34           | J34      |
| BSF 19                 | G26      | BSFD 14-14-*/M18       | G23 | BSM/2BKM 34-198-*     | J34      |
| BSF 19-19-*            | G11      | BSFD 14-PCB            | G25 | BSM/2BKM 34-198-*/*/* | J34      |

## Index

|                        |     |                           |     |                   |     |
|------------------------|-----|---------------------------|-----|-------------------|-----|
| BSM/2BKM 44            | J34 | CA-1/CK 19                | H35 | CKAFD 16-14-*     | H27 |
| BSM/2BKM 44-193-*      | J34 | CA-1/CKV 12               | H35 | CKAM 16-10-*      | H10 |
| BSM/2BKM 44-193-*/**/* | J34 | CA-1/CKV 19               | H35 | CKAM 16-12-*      | H10 |
| BSM/BKM/T22-380-*      | J34 | CA-1/FK 4.5               | D91 | CKAM 16-14-*      | H10 |
| BSM/BKM/T34-198-*      | J34 | CA-1/FKW 4.5              | D92 | CKAWM 16-10-*     | H10 |
| BSM/BKM/T44-193-*      | J34 | CA-1/RKF 30               | F51 | CKAWM 16-12-*     | H10 |
| BSMS 22-1759-*         | J30 | CA-1/RKF 40               | F51 | CKAWM 16-14-*     | H10 |
| BSMS 34-1364-*         | J30 | CA-1/RKF 50               | F51 | CKBF 12-11-*      | H22 |
| BSMS 44-1363-*         | J30 | CA-2/FK 4.5               | D91 | CKBF 12-7-*       | H22 |
| BSS 12-0               | G28 | CA-2/FKW 4.5              | D92 | CKBFD 12-11-*     | H28 |
| BSV 4140-0/11/FF       | N21 | CA-2/RKF 30               | F52 | CKBFD 12-7-*      | H28 |
| BSV 4140-0/16          | P33 | CA-2/RKF 30/S651          | F52 | CKBM 12-11-*      | H12 |
| BSV 4140-0/16/FF       | N21 | CA-2/RKF 40               | F52 | CKBM 12-7-*       | H12 |
| BSV 4140-0/9           | P33 | CA-2/RKF 40/S651          | F52 | CKBWM 12-11-*     | H12 |
| BSV 4140-0/9/ASI       | R19 | CA-2/RKF 50               | F52 | CKBWM 12-7-*      | H12 |
| BSWM 12-001-*          | G5  | CA-2/RKF 50/S651          | F52 | CKCF 12-11-*      | H23 |
| BSWM 12-967-*          | G5  | CBC5 57x-*M               | M14 | CKCF 12-7-*       | H23 |
| BSWM 12-999-*/S101     | G5  | CG-1/2ANGLE-NYLON 10-14MM | U4  | CKCFD 12-11-*     | H28 |
| BSWM 14-000-*/S101     | G6  | CG-1/2ANGLE-NYLON 5-9MM   | U4  | CKCFD 12-7-*      | H28 |
| BSWM 14-002-*          | G6  | CG-1/2STRT-METAL 6-12MM   | U3  | CKCFD 12-9-*      | H28 |
| BSWM 14-755-*          | G6  | CG-1/2STRT-NYLON 10-14MM  | U3  | CKCM 12-11-*      | H12 |
| BSWM 14-836-*          | G7  | CG-1/2STRT-NYLON 5-9MM    | U3  | CKCM 12-11-*/S90  | H12 |
| BSWM 14-917-*          | G7  | CG-1/2STRT-SHLDMTL 6-12MM | U4  | CKCM 12-9-*       | H12 |
| BSWM 14-954-*/S101     | G7  | CG-3/4ANGLE-NYLON 9-16MM  | U4  | CKCM 12-9-*/S90   | H12 |
| BSWM 14-998-*          | G6  | CG-3/4STRT-METAL 13-18MM  | U3  | CKCWM 12-11-*     | H12 |
| BSWM 19-873-*          | G8  | CG-3/4STRT-NYLON 9-16MM   | U3  | CKCWM 12-11-*/S90 | H12 |
| BSWM 19-995-*          | G8  | CG-3/4STRT-SHLDMTL 9-16MM | U4  | CKCWM 12-9-*      | H12 |
| BSWM 19-996-*/S90      | G8  | CG-3/8ANGLE-NYLON 4-8MM   | U4  | CKCWM 12-9-*/S90  | H12 |
| BSWM 22-380-*          | J30 | CG-3/8STRT-METAL 4-8MM    | U3  | CKF 12-0          | H33 |
| BSWM 34-198-*          | J30 | CG-3/8STRT-NYLON 2-6MM    | U3  | CKF 12-11-*       | H20 |
| BSWM 44-193-*          | J30 | CG-3/8STRT-SHLDMTL 4-8MM  | U4  | CKF 12-12-*       | H20 |
| BSWM 5-084-*           | G4  | CG-PG11STRT-METAL 5-10MM  | U3  | CKF 12-12-*/S817  | H20 |
| BSWM 6-085-*           | G4  | CG-PG11STRT-NYLON 5-10MM  | U3  | CKF 12-7-*        | H20 |
| BSWM 7-086-*           | G4  | CG-PG7STRT-METAL 3-6.5MM  | U3  | CKF 12-9-*        | H20 |
| BSWM 8-087-*           | G4  | CG-PG7STRT-NYLON 3-6.5MM  | U3  | CKF 16-0          | H33 |
| BSWMS 22-1759-*        | J30 | CG-PG9ANGLE-NYLON 4-8MM   | U4  | CKF 19-0          | H33 |
| BSWMS 34-1364-*        | J30 | CG-PG9STRT-METAL 4-8MM    | U3  | CKF 19-11-*       | H21 |
| BSWMS 44-1363-*        | J30 | CG-PG9STRT-NYLON 4-8MM    | U3  | CKF 19-15-*       | H21 |
| BSWS 8141-0            | D84 | CK 12-0                   | H31 | CKF 19-19-*       | H21 |
| BSWS 8151-0            | D84 | CK 125-0                  | H31 | CKF 64-6-*        | J46 |
| BSWS 8241-0            | D84 | CK 16-0                   | H31 | CKF 94-9-*        | J46 |
| BSWS 8251-0            | D84 | CK 19-0                   | H31 | CKF-TOOL          | H36 |
| BWS 8141-0             | D84 | CK-CC                     | H36 | CKFD 12-0         | H34 |
| BWS 8151-0             | D84 | CK-TOOL                   | H36 | CKFD 12-11-*      | H25 |
| BWS 8251-0             | D84 | CKAF 16-10-*              | H22 | CKFD 12-12-*      | H25 |
|                        |     | CKAF 16-12-*              | H22 | CKFD 12-12-*/S817 | H25 |
|                        |     | CKAF 16-14-*              | H22 | CKFD 12-7-*       | H25 |
|                        |     | CKAFD 16-10-*             | H27 | CKFD 12-9-*       | H25 |
|                        |     | CKAFD 16-12-*             | H27 | CKFD 16-0         | H34 |
| CA-1/CK 12             | H35 |                           |     |                   |     |

### C

# Connectivity Products

## Index

|                  |     |                                   |         |                                   |     |
|------------------|-----|-----------------------------------|---------|-----------------------------------|-----|
| CKFD 19-0        | H34 | CKRF 12-10-*                      | H24     | Connector, RJ45S 84 IDC (7- 8 mm) | L10 |
| CKFD 19-11-*     | H26 | CKRF 12-6-*                       | H24     | Connector, RJ45S IDC              | K24 |
| CKFD 19-15-*     | H26 | CKRF 12-8-*                       | H24     | Connector,PDP,D9S                 | P10 |
| CKFD 19-19-*     | H26 | CKRFD 12-10-*                     | H29     | Connector,PDP,D9SM                | P10 |
| CKFL 12-0        | H33 | CKRFD 12-6-*                      | H29     | Connector,PDP,SD9S                | P10 |
| CKFL 16-0        | H33 | CKRFD 12-8-*                      | H29     | CS 12-0                           | H32 |
| CKFL 19-0        | H33 | CKRM 12-10-*                      | H14     | CS 125-0                          | H32 |
| CKFL 64-6-*      | J46 | CKRM 12-6-*                       | H14     | CS 16-0                           | H32 |
| CKFL 74-7-*      | J46 | CKRM 12-8-*                       | H14     | CS 19-0                           | H32 |
| CKFL 94-9-*      | J46 | CKRWM 12-10-*                     | H14     | CS-CC                             | H36 |
| CKFMF 622-6-*    | J46 | CKRWM 12-6-*                      | H14     | CSAF 16-10-*                      | H22 |
| CKFMF 822-8-*    | J46 | CKRWM 12-8-*                      | H14     | CSAF 16-12-*                      | H22 |
| CKM 12-11-*      | H5  | CKWM 12-11-*                      | H5      | CSAF 16-14-*                      | H22 |
| CKM 12-11-*/S90  | H5  | CKWM 12-11-*/S90                  | H5      | CSAFD 16-10-*                     | H27 |
| CKM 12-12-*/S101 | H5  | CKWM 12-12-*/S101                 | H5      | CSAFD 16-12-*                     | H27 |
| CKM 12-12-*/S817 | H5  | CKWM 12-12-*/S817                 | H5      | CSAFD 16-14-*                     | H27 |
| CKM 12-7-*       | H5  | CKWM 12-7-*                       | H5      | CSAM 16-10-*                      | H10 |
| CKM 12-7-*/S90   | H5  | CKWM 12-7-*/S90                   | H5      | CSAM 16-12-*                      | H10 |
| CKM 12-9-*       | H5  | CKWM 12-9-*                       | H5      | CSAM 16-14-*                      | H10 |
| CKM 12-9-*/S90   | H5  | CKWM 12-9-*/S90                   | H5      | CSAWM 16-10-*                     | H10 |
| CKM 19-11-*      | H7  | CKWM 19-11-*                      | H7      | CSAWM 16-12-*                     | H10 |
| CKM 19-11-*/S90  | H7  | CKWM 19-11-*/S90                  | H7      | CSAWM 16-14-*                     | H10 |
| CKM 19-15-*      | H7  | CKWM 19-15-*                      | H7      | CSBF 12-11-*                      | H22 |
| CKM 19-15-*/S90  | H7  | CKWM 19-15-*/S90                  | H7      | CSBF 12-7-*                       | H22 |
| CKM 19-19-*      | H7  | CKWM 19-19-*                      | H7      | CSBFD 12-11-*                     | H28 |
| CKM 19-19-*/S101 | H7  | CKWM 19-19-*/S101                 | H7      | CSBFD 12-7-*                      | H28 |
| CKM 19-19-*/S90  | H7  | CKWM 19-19-*/S90                  | H7      | CSBM 12-11-*                      | H12 |
| CKM 622-059-*    | J46 | CKWM 622-059-*                    | J46     | CSBM 12-7-*                       | H12 |
| CKM 64-078-*     | J46 | CKWM 822-287-*                    | J46     | CSBWM 12-11-*                     | H12 |
| CKM 74-079-*     | J46 | CKWMS 12-11-190-*                 | H9      | CSBWM 12-7-*                      | H12 |
| CKM 822-287-*    | J46 | CKWMS 12-7-204-*                  | H9      | CSCF 12-11-*                      | H23 |
| CKM 94-080-*     | J46 | CKWMS 19-191-*                    | H9      | CSCF 12-7-*                       | H23 |
| CKMH 12-11-*     | H16 | CKWMS 622-286-*                   | J46     | CSCFD 12-11-*                     | H28 |
| CKMH 12-11-*/S90 | H16 | CKWMS 822-288-*                   | J46     | CSCFD 12-7-*                      | H28 |
| CKMH 19-19-*     | H16 | CMB 8141-0                        | D88     | CSCFD 12-9-*                      | H28 |
| CKMH 19-19-*/S90 | H16 | CMB 8151-0                        | D88     | CSCM 12-11-*                      | H12 |
| CKMS 12-11-190-* | H9  | CMB 8181-0                        | D88     | CSCM 12-11-*/S90                  | H12 |
| CKMS 12-7-204-*  | H9  | CMB 8241-0                        | D88     | CSCM 12-9-*                       | H12 |
| CKMS 19-191-*    | H9  | CMB 8251-0                        | D88     | CSCM 12-9-*/S90                   | H12 |
| CKMS 622-286-*   | J46 | CMBD 8141-0/PG9                   | K23, L9 | CSCWM 12-11-*                     | H12 |
| CKMS 822-288-*   | J46 | CMBD 8241-0/PG9                   | K23, L9 | CSCWM 12-11-*/S90                 | H12 |
| CKNF 12-9-*      | H23 | CMBS 8141-0                       | D88     | CSCWM 12-9-*                      | H12 |
| CKNF 16-16-*     | H24 | CMBS 8181-0                       | D88     | CSCWM 12-9-*/S90                  | H12 |
| CKNFD 12-9-*     | H29 | CMBS 8241-0                       | D88     | CSF 12-0                          | H33 |
| CKNFD 16-16-*    | H29 | CMBSD 8141-0/PG9                  | K23, L9 | CSF 12-11-*                       | H20 |
| CKNM 12-9-*      | H14 | CMBSD 8241-0/PG9                  | K23, L9 | CSF 12-12-*                       | H20 |
| CKNM 16-16-*     | H14 | Connector, FW, RJ45S 84 IDC       | K24     | CSF 12-12-*/S817                  | H20 |
| CKNWM 12-9-*     | H14 | Connector, FW, RJ45S 86 IDC CAT 6 | K24     | CSF 12-7-*                        | H20 |
| CKNWM 16-16-*    | H14 | Connector, RJ45S 42 IDC           | L10     | CSF 16-0                          | H33 |

## Index

|                   |     |                   |     |                    |     |
|-------------------|-----|-------------------|-----|--------------------|-----|
| CSF 19-0          | H33 | CSNF 16-16-*      | H24 | CSSM 64-078-*      | J46 |
| CSF 19-11-*       | H21 | CSNFD 12-9-*      | H29 | CSSM 74-079-*      | J46 |
| CSF 19-15-*       | H21 | CSNFD 16-16-*     | H29 | CSSM 822-287-*     | J46 |
| CSF 19-19-*       | H21 | CSNM 12-9-*       | H14 | CSSM 94-080-*      | J46 |
| CSF 622-6-*       | J46 | CSNM 16-16-*      | H14 | CSSMS 622-286-*    | J46 |
| CSF 64-6-*        | J46 | CSNWM 12-9-*      | H14 | CSSMS 822-288-*    | J46 |
| CSF 74-7-*        | J46 | CSNWM 16-16-*     | H14 | CSSNM 12-9-*       | H15 |
| CSF 822-8-*       | J46 | CSRF 12-10-*      | H24 | CSSNM 16-16-*      | H15 |
| CSF 94-9-*        | J46 | CSRF 12-6-*       | H24 | CSSNWM 12-9-*      | H15 |
| CSFD 12-0         | H34 | CSRF 12-8-*       | H24 | CSSNWM 16-16-*     | H15 |
| CSFD 12-11-*      | H25 | CSRFD 12-10-*     | H29 | CSSRM 12-10-*      | H13 |
| CSFD 12-12-*      | H25 | CSRFD 12-6-*      | H29 | CSSRM 12-6-*       | H13 |
| CSFD 12-12-*/S817 | H25 | CSRFD 12-8-*      | H29 | CSSRM 12-8-*       | H13 |
| CSFD 12-7-*       | H25 | CSRM 12-10-*      | H14 | CSSRWM 12-10-*     | H13 |
| CSFD 12-9-*       | H25 | CSRM 12-6-*       | H14 | CSSRWM 12-6-*      | H13 |
| CSFD 16-0         | H34 | CSRM 12-8-*       | H14 | CSSRWM 12-8-*      | H13 |
| CSFD 19-11-*      | H26 | CSRWM 12-10-*     | H14 | CSSWM 12-11-*      | H6  |
| CSFD 19-15-*      | H26 | CSRWM 12-6-*      | H14 | CSSWM 12-11-*/S90  | H6  |
| CSFD 19-19-*      | H26 | CSRWM 12-8-*      | H14 | CSSWM 12-12-*/S101 | H6  |
| CSFF 622-6-*      | J46 | CSS 12-0          | H32 | CSSWM 12-12-*/S817 | H6  |
| CSFF 822-8-*      | J46 | CSS 125-0         | H32 | CSSWM 12-7-*       | H6  |
| CSFL 12-0         | H33 | CSS 16-0          | H32 | CSSWM 12-7-*/S90   | H6  |
| CSFL 16-0         | H33 | CSS 19-0          | H32 | CSSWM 12-9-*       | H6  |
| CSFL 19-0         | H33 | CSSAM 16-10-*     | H11 | CSSWM 12-9-*/S90   | H6  |
| CSFL 64-6-*       | J46 | CSSAM 16-12-*     | H11 | CSSWM 19-11-*      | H8  |
| CSFL 74-7-*       | J46 | CSSAM 16-14-*     | H11 | CSSWM 19-11-*/S90  | H8  |
| CSFL 94-9-*       | J46 | CSSAWM 16-10-*    | H11 | CSSWM 19-15-*      | H8  |
| CSM 12-11-*       | H5  | CSSAWM 16-12-*    | H11 | CSSWM 19-15-*/S90  | H8  |
| CSM 12-11-*/S90   | H5  | CSSAWM 16-14-*    | H11 | CSSWM 19-19-*      | H8  |
| CSM 12-12-*/S101  | H5  | CSSBM 12-11-*     | H13 | CSSWM 19-19-*/S101 | H8  |
| CSM 12-12-*/S817  | H5  | CSSBM 12-7-*      | H13 | CSSWM 19-19-*/S90  | H8  |
| CSM 12-7-*        | H5  | CSSBWM 12-11-*    | H13 | CSSWM 622-059-*    | J46 |
| CSM 12-7-*/S90    | H5  | CSSBWM 12-7-*     | H13 | CSSWM 822-287-*    | J46 |
| CSM 12-9-*        | H5  | CSSM 12-11-*      | H6  | CSSWMS 622-286-*   | J46 |
| CSM 12-9-*/S90    | H5  | CSSM 12-11-*/S90  | H6  | CSSWMS 822-288-*   | J46 |
| CSM 19-11-*       | H7  | CSSM 12-12-*/S101 | H6  | CSWM 12-11-*       | H5  |
| CSM 19-11-*/S90   | H7  | CSSM 12-12-*/S817 | H6  | CSWM 12-11-*/S90   | H5  |
| CSM 19-15-*       | H7  | CSSM 12-7-*       | H6  | CSWM 12-12-*/S101  | H5  |
| CSM 19-15-*/S90   | H7  | CSSM 12-7-*/S90   | H6  | CSWM 12-12-*/S817  | H5  |
| CSM 19-19-*       | H7  | CSSM 12-9-*       | H6  | CSWM 12-7-*        | H5  |
| CSM 19-19-*/S101  | H7  | CSSM 12-9-*/S90   | H6  | CSWM 12-7-*/S90    | H5  |
| CSM 19-19-*/S90   | H7  | CSSM 19-11-*      | H8  | CSWM 12-9-*        | H5  |
| CSM 64-078-*      | J46 | CSSM 19-11-*/S90  | H8  | CSWM 12-9-*/S90    | H5  |
| CSM 74-079-*      | J46 | CSSM 19-15-*      | H8  | CSWM 19-11-*       | H7  |
| CSM 94-080-*      | J46 | CSSM 19-15-*/S90  | H8  | CSWM 19-11-*/S90   | H7  |
| CSMS 12-11-190-*  | H9  | CSSM 19-19-*      | H8  | CSWM 19-15-*       | H7  |
| CSMS 12-7-204-*   | H9  | CSSM 19-19-*/S101 | H8  | CSWM 19-15-*/S90   | H7  |
| CSMS 19-191-*     | H9  | CSSM 19-19-*/S90  | H8  | CSWM 19-19-*       | H7  |
| CSNF 12-9-*       | H23 | CSSM 622-059-*    | J46 | CSWM 19-19-*/S101  | H7  |

# Connectivity Products

## Index

|                           |     |                                   |     |                                |     |
|---------------------------|-----|-----------------------------------|-----|--------------------------------|-----|
| CSWM 19-19-*/S90          | H7  | E-WKC 8T-PX3-930-*                | D33 | FFV 1/2INCH BLACK 50 FOOT ROLL | U8  |
| CSWMS 12-11-190-*         | H9  | E-WKS 8T-264-*                    | D40 | FFV 1/4INCH BLACK (10/BAG-6IN) | U8  |
| CSWMS 12-7-204-*          | H9  | E-WKS 8T-930-*                    | D40 | FFV 1/4INCH BLACK 50 FOOT ROLL | U8  |
| CSWMS 19-191-*            | H9  | E-WSC 8T-264-*                    | D39 | FFV 1INCH BLACK (10/BAG-6IN)   | U8  |
|                           |     | E-WSC 8T-930-*                    | D39 | FFV 1INCH BLACK 50 FOOT ROLL   | U8  |
|                           |     | E-WSC 8T-930-*/S1115              | D39 | FFV 3/8INCH BLACK (10/BAG-6IN) | U8  |
|                           |     | E-WSS 8T-264-*                    | D40 | FFV 3/8INCH BLACK 50 FOOT ROLL | U8  |
|                           |     | E-WSS 8T-930-*                    | D40 | FFV 5/8INCH BLACK (10/BAG-6IN) | U8  |
| D9S 45x-*M                | P9  | ESBW 3 (10/BAG)                   | E18 | FFV 5/8INCH BLACK 50 FOOT ROLL | U8  |
| D9S/T 45x-*M              | P8  | ESBW 4 (10/BAG)                   | E18 | FFW 1INC 2FOOT                 | U10 |
| D9SM 45x-*M               | P9  | ESBW 5 (10/BAG)                   | E18 | FFW 2INC 2FOOT                 | U10 |
| D9SM/T 45x-*M             | P8  | ESGM 3L (10/BAG)                  | C29 | FFW 3INC 2FOOT                 | U10 |
| DBK 8151-0                | D90 | ESGM 3P (10/BAG)                  | C29 | FFW 4INC 2FOOT                 | U10 |
| DBKM 8151-0               | D90 | ESGM 4L (10/BAG)                  | C29 | FFW 5INC 2FOOT                 | U10 |
| DBS 8151-0                | D90 | ESGM 4P (10/BAG)                  | C29 | FFW 6INC 2FOOT                 | U10 |
| DBSM 8151-0               | D90 | ESHM 3L (10/BAG)                  | C28 | FFW 7INC 2FOOT                 | U10 |
| DKF 26-25-*               | H30 | ESHM 3P (10/BAG)                  | C28 | FFW 8INC 2FOOT                 | U10 |
| DKF 28-27-*               | H30 | ESHM 4L (10/BAG)                  | C28 | FK 10-*                        | D48 |
| DKM 26-631-*              | H17 | ESHM 4P (10/BAG)                  | C28 | FK 10-*/14.5                   | D53 |
| DKM 28-061-*              | H17 | ESM 3S (10/BAG)                   | C28 | FK 10-*/14.5/NPT               | D56 |
| DKWM 26-631-*             | H17 | ESM 4S (10/BAG)                   | C28 | FK 10-*/18.25                  | D51 |
| DKWM 28-061-*             | H17 | ESM 6S (10/BAG)                   | C28 | FK 10-*/M20                    | D58 |
| DSF 26-25-*               | H30 | EWAK 4 PCB (10/BAG)               | D94 | FK 12-*                        | D48 |
| DSF 28-27-*               | H30 | EWAK 4.4 PCB (10/BAG)             | D94 | FK 12-*/14.5                   | D53 |
| DSM 26-631-*              | H17 | EWAK 4.5 PCB (10/BAG)             | D94 | FK 12-*/14.5/NPT               | D56 |
| DSM 28-061-*              | H17 | EWAS 4.4 (10/BAG)                 | D94 | FK 12-*/18.25                  | D51 |
| DSSM 26-631-*             | H18 | EWAS 4.5 (10/BAG)                 | D94 | FK 12-*/M20                    | D58 |
| DSSM 28-061-*             | H18 | EWAS 6 (10/BAG)                   | D94 | FK 25-*M                       | R18 |
| DSSWM 26-631-*            | H18 | EWAS 8 (10/BAG)                   | D94 | FK 25-*M/14.5                  | R17 |
| DSSWM 28-061-*            | H18 | EWASW 4.5 (10/BAG)                | D94 | FK 25-*M/14.75                 | R17 |
| DSWM 26-631-*             | H17 |                                   |     | FK 25-*M/M20                   | R17 |
| DSWM 28-061-*             | H17 |                                   |     | FK 4.2-*                       | D46 |
| DUST CAP RKM (50/PACKAGE) | F63 |                                   |     | FK 4.21-*                      | D46 |
| DUST CAP RSM (50/PACKAGE) | F63 |                                   |     | FK 4.22-*                      | D46 |
|                           |     | FF 1/2INCH BLACK (10/BAG)         | U8  | FK 4.4                         | D63 |
|                           |     | FF 1/2INCH BLACK 50 FOOT ROLL     | U8  | FK 4.4-*                       | D46 |
|                           |     | FF 3/4INCH BLACK (10/BAG)         | U8  | FK 4.4-*/14.5                  | D52 |
|                           |     | FF 3/4INCH BLACK 50 FOOT ROLL     | U8  | FK 4.4-*/14.5/S613             | D52 |
| E-RKC 8T-264-*            | D39 | FF 78 AL                          | F63 | FK 4.4-*/18.25                 | D49 |
| E-RKC 8T-930-*            | D39 | FFFS BLK ID 1-INCH (10/BAG-6IN)   | U9  | FK 4.4-*/18.25/S613            | D49 |
| E-RKC 8T-930-*/S1115      | D39 | FFFS BLK ID 1-INCH-30M            | U9  | FK 4.4-*/18.25/S621            | D49 |
| E-RKS 8T-264-*            | D40 | FFFS BLK ID 3/4-INCH (10/BAG-6IN) | U9  | FK 4.4-*/M20                   | D57 |
| E-RKS 8T-930-*            | D40 | FFFS BLK ID 3/4-INCH-30M          | U9  | FK 4.4-*/S613                  | D46 |
| E-RSC 8T-264-*            | D39 | FFFS WHT ID 3/8-INCH (10/BAG-6IN) | U9  | FK 4.4-*/S621                  | D46 |
| E-RSC 8T-930-*            | D39 | FFFS WHT ID 3/8-INCH-30M          | U9  | FK 4.4/18.25                   | D62 |
| E-RSC 8T-930-*/S1115      | D39 | FFFS WHT ID 5/8-INCH (10/BAG-6IN) | U9  | FK 4.5                         | D63 |
| E-RSS 8T-264-*            | D40 | FFFS WHT ID 5/8-INCH-30M          | U9  | FK 4.5-*                       | D46 |
| E-RSS 8T-930-*            | D40 | FFV 1 1/2INCH BLACK (10/BAG-6IN)  | U8  | FK 4.5-*/14.5                  | D52 |
| E-WKC 8T-264-*            | D39 | FFV 1 1/2INCH BLACK 50 FOOT ROLL  | U8  |                                |     |
| E-WKC 8T-930-*            | D39 | FFV 1/2INCH BLACK (10/BAG-6IN)    | U8  |                                |     |
| E-WKC 8T-930-*/S1115      | D39 |                                   |     |                                |     |



## Index

|                     |     |                    |          |                              |         |
|---------------------|-----|--------------------|----------|------------------------------|---------|
| FK 4.5-*/18.25      | D49 | FKB 3-*/18.25/S690 | E13      | FKFDK 4.5                    | D71     |
| FK 4.5-*/18.25/S621 | D49 | FKB 4-*/14.5       | E9       | FKFDKW 4.5                   | D80     |
| FK 4.5-*/18.25/S627 | D49 | FKB 4-*/14.5/NPT   | E11      | FKFDL 4.4                    | D68     |
| FK 4.5-*/18.25/S653 | D49 | FKB 4-*/18.25      | E14      | FKFDL 4.5                    | D68     |
| FK 4.5-*/M20        | D57 | FKB 5-*/14.5       | E10      | FKFDL 57                     | M43     |
| FK 4.5-*/S627       | D46 | FKB 5-*/14.5/NPT   | E12      | FKFDL 6                      | D68     |
| FK 4.5-*/S653       | D46 | FKB 5-*/14.5/S690  | E10      | FKFDL 8                      | D69     |
| FK 4.5-PCB          | D75 | FKB 5-*/18.25      | E14      | FKFDL 84                     | K14     |
| FK 4.6-*            | D47 | FKB 5-*/18.25/S690 | E14      | FKFDLW 4.5                   | D79     |
| FK 4.6-*/14.5       | D52 | FKB 6-*/14.5       | E10      | FKFDLW 45                    | P13     |
| FK 4.6-*/18.25      | D50 | FKB 6-*/18.25      | E14      | FKFDV 48x-*M                 | P23     |
| FK 45-PCB           | P14 | FKB FSB 3          | E15      | FKFDV 49x-*M                 | N9      |
| FK 57-*/M           | M40 | FKB FSB 4          | E15      | FKFDW 4.5                    | D80     |
| FK 57-*/M/14.5      | M39 | FKB FSB 5          | E15      | FKFDW 4.5-*                  | D79     |
| FK 57-*/M/14.75     | M39 | FKBP 3-*           | E15      | FKFDW 45-PCB                 | P13     |
| FK 57-*/M/M20       | M39 | FKBP 5-*           | E15      | FKK-CC                       | D95     |
| FK 57-PCB           | M42 | FKD 10-*           | D65      | FKM 4.4-*                    | D61     |
| FK 57-PCB KIT       | M42 | FKD 12-*           | D65      | FKM 4.5-*                    | D61     |
| FK 6-*              | D47 | FKD 4.4-*          | D64      | FKM 4.5-*/S653               | D61     |
| FK 6-*/14.5         | D52 | FKD 4.5-*          | D64      | FKM 4.6-*                    | D61     |
| FK 6-*/18.25        | D50 | FKD 4.5-*/S653     | D64      | FKM 6-*                      | D61     |
| FK 6-*/M20          | D57 | FKD 6-*            | D64      | FKM 8-*                      | D61     |
| FK 8-*              | D47 | FKD 8-*            | D65      | FKM FS 57/M12                | M25     |
| FK 8-*/14.5         | D53 | FKD FKD 44/M12     | K22, L8  | FKMR 4-ESM 3S                | C27     |
| FK 8-*/14.5/NPT     | D56 | FKDW 4.5-*         | D78      | FKMR 4-ESM 3S                | V48     |
| FK 8-*/18.25        | D50 | FKFD 10-*          | D67      | FKMR 4.4-ESM 4S              | C27     |
| FK 8-*/18.25/S1505  | D50 | FKFD 12-*          | D67      | FKMR 4.4-ESM 4S              | V48     |
| FK 8-*/M20          | D58 | FKFD 25x-*M        | R9       | FKMW 4.5-*                   | D78     |
| FK 8.6-*            | D47 | FKFD 4.4           | D70      | FKN 5-*                      | D46     |
| FK 8.6-*/14.5       | D53 | FKFD 4.4-*         | D66      | FKP 4.4-*                    | D81     |
| FK 8.6-*/14.5/NPT   | D56 | FKFD 4.4-*/S621    | D66      | FKP 4.4-*/S621               | D81     |
| FK 8.6-*/18.25      | D50 | FKFD 4.5           | D70      | FKP 4.5-*                    | D81     |
| FK 8.6-*/M20        | D58 | FKFD 4.5-*         | D66      | FKP 4.5-*/S621               | D81     |
| FK 84-PCB           | K13 | FKFD 4.5-*/S653    | D66      | FKSDD RJ45SF 44              | K22, L8 |
| FK 84-PCB KIT       | K13 | FKFD 57-PCB        | M43      | FKSDD RJ45SF 44/ST           | K22, L8 |
| FK FS 4.4/M12       | D82 | FKFD 57x-*M        | M11, M13 | FKSDE 84x-*M                 | K9      |
| FK FS 4.5/M12       | D82 | FKFD 6             | D70      | FKSDED 42x-*M                | L4      |
| FK FS 4.6/M12       | D82 | FKFD 6-*           | D66      | FKSDED 44x-*M                | K19     |
| FK FS 6/M12         | D82 | FKFD 8             | D70      | FKSDWE D9S FKSDWE 45x-*M-*M  | P9      |
| FK FS 8/M12         | D82 | FKFD 8-*           | D67      | FKSDWE D9S/T 45x-*M          | P8      |
| FK-CC               | D95 | FKFD 8-*/S1505     | D67      | FKSDWE D9SM/T 45x-*M         | P8      |
| FKB 2-*/14.5        | E9  | FKFD 84-PCB        | K14      | FKSDWE SD9S FKSDWE 45x-*M-*M | P9      |
| FKB 2-*/14.5/NPT    | E11 | FKFD 84x-*M        | K7       | FKSDWE SD9S/T 45x-*M         | P8      |
| FKB 2-*/18.25       | E13 | FKFD BK52C 57x-*M  | M15      | FKV 48-*M                    | P29     |
| FKB 3-*/14.5        | E9  | FKFD CBC5 57x-*M   | M15      | FKV 48-*M/14.5               | P28     |
| FKB 3-*/14.5/NPT    | E11 | FKFDD 44x-*M       | K17      | FKV 48-*M/14.75              | P28     |
| FKB 3-*/14.5/S690   | E9  | FKFDH 4.4          | D75      | FKV 48-*M/M20                | P28     |
| FKB 3-*/18.25       | E13 | FKFDH 4.5          | D75      | FKV 49-*M                    | N20     |
| FKB 3-*/18.25/S662  | E13 | FKFDHOW 4.5        | D76      | FKV 49-*M/14.5               | N19     |

# Connectivity Products

## Index

|                     |     |                     |     |                         |          |
|---------------------|-----|---------------------|-----|-------------------------|----------|
| FKV 49-*M/14.75     | N19 | FS 4.5-*/14.5       | D52 | FSB 3-*/18.25           | E13      |
| FKV 49-*M/M20       | N19 | FS 4.5-*/18.25      | D49 | FSB 3-*/18.25/S649      | E13      |
| FKV FSV 49/M12      | N16 | FS 4.5-*/18.25/S621 | D49 | FSB 3-*/18.25/S662      | E13      |
| FKV-CC              | D95 | FS 4.5-*/18.25/S627 | D49 | FSB 3-*/18.25/S690      | E13      |
| FKW 4.5-*           | D77 | FS 4.5-*/18.25/S653 | D49 | FSB 3-*/18.25/S881      | E13      |
| FKW 4.5-*/14.5      | D77 | FS 4.5-*/M20        | D57 | FSB 4-*/14.5            | E9       |
| FKW 4.5-*/S653      | D77 | FS 4.5-*/PG13.5     | D60 | FSB 4-*/14.5/NPT        | E11      |
| FKW 4.5*/14.5/NPT   | D77 | FS 4.5-*/PG16       | D59 | FSB 4-*/18.25           | E14      |
| FKW 45-PCB KIT      | P14 | FS 4.5-*/S627       | D46 | FSB 4-*/18.25/S621      | E14      |
| FKW FSW 4.5/M12     | D82 | FS 4.5-*/S653       | D46 | FSB 4-*/18.25/S727      | E14      |
| FKW FSW 45/M12      | P15 | FS 4.5-PCB          | D75 | FSB 5-*/14.5            | E10      |
| FS 10-*             | D48 | FS 4.5/14.5         | D63 | FSB 5-*/14.5/NPT        | E12      |
| FS 10-*/14.5        | D53 | FS 4.6-*            | D47 | FSB 5-*/14.5/NPT/S690   | E12      |
| FS 10-*/14.5/NPT    | D56 | FS 4.6-*/14.5       | D52 | FSB 5-*/14.5/S690       | E10      |
| FS 10-*/18.25       | D51 | FS 4.6-*/18.25      | D50 | FSB 5-*/18.25           | E14      |
| FS 10-*/M20         | D58 | FS 57-*M            | M40 | FSB 5-*/18.25/S690      | E14      |
| FS 10-*/PG13.5      | D60 | FS 57-*M/14.5       | M39 | FSB 6-*/14.5            | E10      |
| FS 10-*/PG16        | D59 | FS 57-*M/14.75      | M39 | FSB 6-*/14.5/NPT        | E12      |
| FS 12-*             | D48 | FS 57-*M/M20        | M39 | FSB 6-*/18.25           | E14      |
| FS 12-*/14.5        | D53 | FS 57-PCB           | M42 | FSD 10-*                | D65      |
| FS 12-*/14.5/NPT    | D56 | FS 57-PCB KIT       | M42 | FSD 12-*                | D65      |
| FS 12-*/18.25       | D51 | FS 6-*              | D47 | FSD 4.4-*               | D64      |
| FS 12-*/M20         | D58 | FS 6-*/14.5         | D52 | FSD 4.5-*               | D64      |
| FS 12-*/PG13.5      | D60 | FS 6-*/18.25        | D50 | FSD 4.5-*/S653          | D64      |
| FS 12-*/PG16        | D59 | FS 6-*/M20          | D57 | FSD 6-*                 | D64      |
| FS 25-*M            | R18 | FS 6-*/PG13.5       | D60 | FSD 8-*                 | D65      |
| FS 25-*M/14.5       | R17 | FS 6-*/PG16         | D59 | FSDW 4.5-*              | D78      |
| FS 25-*M/14.75      | R17 | FS 8-*              | D47 | FSFD 10-*               | D67      |
| FS 25-*M/M20        | R17 | FS 8-*/14.5         | D53 | FSFD 12-*               | D67      |
| FS 4.2-*            | D46 | FS 8-*/14.5/NPT     | D56 | FSFD 25x-*M             | R9       |
| FS 4.21-*           | D46 | FS 8-*/18.25        | D50 | FSFD 2VBWK WKC 5724-DCL | M46      |
| FS 4.22-*           | D46 | FS 8-*/18.25/S1505  | D50 | FSFD 4.4                | D70      |
| FS 4.4              | D63 | FS 8-*/M20          | D58 | FSFD 4.4-*              | D66      |
| FS 4.4-*            | D46 | FS 8-*/PG13.5       | D60 | FSFD 4.4-*/S621         | D66      |
| FS 4.4-*/14.5       | D52 | FS 8-*/PG16         | D59 | FSFD 4.5                | D70      |
| FS 4.4-*/14.5/S613  | D52 | FS 8.6-*            | D47 | FSFD 4.5-*              | D66      |
| FS 4.4-*/14.5/S621  | D52 | FS 8.6-*/14.5       | D53 | FSFD 4.5-*/S653         | D66      |
| FS 4.4-*/18.25      | D49 | FS 8.6-*/14.5/NPT   | D56 | FSFD 57-PCB             | M43      |
| FS 4.4-*/18.25/S613 | D49 | FS 8.6-*/18.25      | D50 | FSFD 57x-*M             | M11, M13 |
| FS 4.4-*/18.25/S621 | D49 | FS 8.6-*/M20        | D58 | FSFD 6                  | D70      |
| FS 4.4-*/M20        | D57 | FS 8.6-*/PG16       | D59 | FSFD 6-*                | D66      |
| FS 4.4-*/PG13.5     | D60 | FS 84-PCB KIT       | K13 | FSFD 8                  | D70      |
| FS 4.4-*/PG16       | D59 | FS-CC               | D95 | FSFD 8-*                | D67      |
| FS 4.4-*/S613       | D46 | FSB 2-*/14.5        | E9  | FSFD 8-*/S1505          | D67      |
| FS 4.4-*/S621       | D46 | FSB 2-*/14.5/NPT    | E11 | FSFD 84-PCB             | K14      |
| FS 4.4/14.5         | D63 | FSB 2-*/18.25       | E13 | FSFD 84x-*M             | K6       |
| FS 4.4/18.25        | D62 | FSB 3-*/14.5        | E9  | FSFD BK52C 57x-*M       | M15      |
| FS 4.5              | D63 | FSB 3-*/14.5/NPT    | E11 | FSFD CBC5 57x-*M        | M15      |
| FS 4.5-*            | D46 | FSB 3-*/14.5/S690   | E9  | FSFDD 44x-*M            | K16      |

## Index

|                              |          |                      |     |                        |     |
|------------------------------|----------|----------------------|-----|------------------------|-----|
| FSFDH 4.4                    | D75      | FSW 45-PCB KIT       | P14 | GKDWM 44-*M            | J13 |
| FSFDH 4.5                    | D75      |                      |     | GKDWM 44-*M/S4000      | J13 |
| FSFDK 4.4                    | D71      | <b>G</b>             |     | GSDF 30-*M/14.5/NPT    | J14 |
| FSFDK 4.5                    | D71      |                      |     | GSDF 30-*M/14.75/NPT   | J14 |
| FSFDKW 4.5                   | D80      | GKDF 30-*M/14.5/NPT  | J14 | GSDF 30-*M/M20         | J14 |
| FSFDL 4.4                    | D68      | GKDF 30-*M/14.75/NPT | J14 | GSDF 32-*M/14.5/NPT    | J14 |
| FSFDL 4.5                    | D68      | GKDF 30-*M/M20       | J14 | GSDF 32-*M/14.75/NPT   | J14 |
| FSFDL 57                     | M43      | GKDF 32-*M/14.5/NPT  | J14 | GSDF 32-*M/M20         | J14 |
| FSFDL 6                      | D68      | GKDF 32-*M/14.75/NPT | J14 | GSDF 34-*M/14.5/NPT    | J14 |
| FSFDL 8                      | D69      | GKDF 32-*M/M20       | J14 | GSDF 34-*M/14.75/NPT   | J14 |
| FSFDL 84                     | K14      | GKDF 34-*M/14.5/NPT  | J14 | GSDF 34-*M/M20         | J14 |
| FSFDLW 4.5                   | D79      | GKDF 34-*M/14.75/NPT | J14 | GSDF 40-*M/14.5/NPT    | J14 |
| FSFDLW 45                    | P13      | GKDF 34-*M/M20       | J14 | GSDF 40-*M/14.75/NPT   | J14 |
| FSFDV 48x-*M                 | P23      | GKDF 40-*M/14.5/NPT  | J14 | GSDF 40-*M/M20         | J14 |
| FSFDV 49x-*M                 | N9       | GKDF 40-*M/14.75/NPT | J14 | GSDF 42-*M/14.5/NPT    | J14 |
| FSFDW 4.5                    | D80      | GKDF 40-*M/M20       | J14 | GSDF 42-*M/14.75/NPT   | J14 |
| FSFDW 4.5-*                  | D79      | GKDF 42-*M/14.5/NPT  | J14 | GSDF 42-*M/M20         | J14 |
| FSFDW 45-PCB                 | P13      | GKDF 42-*M/14.75/NPT | J14 | GSDF 44-*M/14.5/NPT    | J14 |
| FSK-CC                       | D95      | GKDF 42-*M/M20       | J14 | GSDF 44-*M/14.75/NPT   | J14 |
| FSMR 4-SKM 3                 | C27, V48 | GKDF 44-*M/14.5/NPT  | J14 | GSDF 44-*M/M20         | J14 |
| FSMR 4.4-SKM 4               | C27, V48 | GKDF 44-*M/14.75/NPT | J14 | GSDF-CC                | J26 |
| FSN 5-*                      | D46      | GKDF 44-*M/M20       | J14 | GSDM 30-*M             | J13 |
| FSSDE 84x-*M                 | K9       | GKDF-CC              | J26 | GSDM 30-*M/S4000       | J13 |
| FSSDED 42x-*M                | L4       | GKDM 30-*M           | J13 | GSDM 30-0              | J14 |
| FSSDED 44x-*M                | K19      | GKDM 30-*M/S4000     | J13 | GSDM 32-*M             | J13 |
| FSSDWE D9S FKSDWE 45x-*M-*M  | P9       | GKDM 30-0            | J14 | GSDM 32-*M/S4000       | J13 |
| FSSDWE D9S FSSDWE 45x-*M-*M  | P9       | GKDM 32-*M           | J13 | GSDM 34-*M             | J13 |
| FSSDWE D9S/T 45x-*M          | P8       | GKDM 32-*M/S4000     | J13 | GSDM 34-*M/S4000       | J13 |
| FSSDWE D9SM FKSDWE 45x-*M-*M | P9       | GKDM 34-*M           | J13 | GSDM 40-*M             | J13 |
| FSSDWE D9SM FSSDWE 45x-*M-*M | P9       | GKDM 34-*M/S4000     | J13 | GSDM 40-*M/S4000       | J13 |
| FSSDWE D9SM/T 45x-*M         | P8       | GKDM 40-*M           | J13 | GSDM 40-0              | J14 |
| FSSDWE SD9S FKSDWE 45x-*M-*M | P9       | GKDM 40-*M/S4000     | J13 | GSDM 42-*M             | J13 |
| FSSDWE SD9S FSSDWE 45x-*M-*M | P9       | GKDM 40-0            | J14 | GSDM 42-*M/S4000       | J13 |
| FSSDWE SD9S/T 45x-*M         | P8       | GKDM 42-*M           | J13 | GSDM 44-*M             | J13 |
| FST 1IN 12YARDS              | U10      | GKDM 42-*M/S4000     | J13 | GSDM 44-*M/S4000       | J13 |
| FSV 48-*M                    | P29      | GKDM 44-*M           | J13 | GSDM BKM 34-0          | J23 |
| FSV 48-*M/14.5               | P28      | GKDM 44-*M/S4000     | J13 | GSDM BKM 44-0          | J23 |
| FSV 48-*M/14.75              | P28      | GKDM-CC              | J26 | GSDM RKM 34-0          | J23 |
| FSV 48-*M/M20                | P28      | GKDM-MC              | J26 | GSDM RKM 44-0          | J23 |
| FSV 49-*M                    | N20      | GKDWM 30-*M          | J13 | GSDM-CC                | J26 |
| FSV 49-*M/14.5               | N19      | GKDWM 30-*M/S4000    | J13 | GSDM-MC                | J26 |
| FSV 49-*M/14.75              | N19      | GKDWM 32-*M          | J13 | GSDM/2GKDM 30          | J17 |
| FSV 49-*M/M20                | N19      | GKDWM 32-*M/S4000    | J13 | GSDM/2GKDM 30-*        | J17 |
| FSV-CC                       | D95      | GKDWM 34-*M          | J13 | GSDM/2GKDM 30-* /S4000 | J17 |
| FSW 4.5-*                    | D77      | GKDWM 34-*M/S4000    | J13 | GSDM/2GKDM 32-*        | J17 |
| FSW 4.5-*/14.5               | D77      | GKDWM 40-*M          | J13 | GSDM/2GKDM 32-* /S4000 | J17 |
| FSW 4.5-*/14.5/NPT           | D77      | GKDWM 40-*M/S4000    | J13 | GSDM/2GKDM 34-*        | J17 |
| FSW 4.5-*/S653               | D77      | GKDWM 42-*M          | J13 | GSDM/2GKDM 34-* /S4000 | J17 |
| FSW 45-PCB                   | P14      | GKDWM 42-*M/S4000    | J13 | GSDM/2GKDM 40          | J17 |



## Index

|                        |     |                        |     |                        |     |
|------------------------|-----|------------------------|-----|------------------------|-----|
| NM-RKC 4T-*/S849       | D43 | PKG 4Z-*/S90/S618      | C5  | PKW 3Z-*               | C4  |
| NM-RKC 4T-*/S90/S849   | D43 | PKG 4Z-*/S90/S653      | C5  | PKW 3Z-*/S760          | C4  |
| NM-RSC 4.4T-*/S849     | D43 | PKG 4Z-3/S90-SP        | C14 | PKW 3Z-*/S90           | C4  |
| NM-RSC 4.4T-*/S90/S849 | D43 | PKG 5M 57-TR           | M24 | PKW 3Z-*/S90/S101      | C4  |
| NM-RSC 4.5T-*/S849     | D43 | PKG 5M PKG 5M-57x      | M19 | PKW 3Z-*/S90/S618      | C4  |
| NM-RSC 4.5T-*/S90/S849 | D43 | PKG 5M PKW 5M-57x      | M19 | PKW 3Z-3/S90-SP        | C14 |
| NM-RSC 4T-*/S849       | D43 | PKG 5M PSG 5M-57x      | M19 | PKW 3Z-N7X2-*          | C11 |
| NM-RSC 4T-*/S90/S849   | D43 | PKG 5M PSW 5M-57x      | M19 | PKW 3Z-N7X2-*/S90      | C11 |
| NM-WKC 4.4T-*/S849     | D43 | PKG 5M RKT 57x*M       | M19 | PKW 3Z-N7X2-*/S90/S101 | C11 |
| NM-WKC 4.4T-*/S90/S849 | D43 | PKG 5M RST 57x*M       | M19 | PKW 3Z-N7X2-*/S90/S618 | C11 |
| NM-WKC 4.5T-*/S849     | D43 | PKG 5M WKT 57x*M       | M19 | PKW 3Z-P7X2-*          | C11 |
| NM-WKC 4.5T-*/S90/S849 | D43 | PKG 5M WST 57x*M       | M19 | PKW 3Z-P7X2-*/S90      | C11 |
| NM-WKC 4T-*/S849       | D43 | PKG 5M-57x             | M19 | PKW 3Z-P7X2-*/S90/S101 | C11 |
| NM-WKC 4T-*/S90/S849   | D43 | PKG 5Z 57x-*M          | M20 | PKW 3Z-P7X2-*/S90/S618 | C11 |
| NM-WSC 4.4T-*/S849     | D43 | PKG 5Z PKGZ 5Z 57x-*M  | M20 | PKW 4M-*               | C8  |
| NM-WSC 4.4T-*/S90/S849 | D43 | PKG 5Z PSG 57x-*M      | M20 | PKW 4M-*/S760          | C8  |
| NM-WSC 4.5T-*/S849     | D43 | PKG 5Z RKT 57x-*M      | M20 | PKW 4M-*/S90           | C8  |
| NM-WSC 4.5T-*/S90/S849 | D43 | PKG 5Z RST 57x-*M      | M20 | PKW 4M-*/S90/S101      | C8  |
| NM-WSC 4T-*/S849       | D43 | PKG 5Z WKT 57x-*M      | M20 | PKW 4M-*/S90/S618      | C8  |
| NM-WSC 4T-*/S90/S849   | D43 | PKG 5Z WST 57x-*M      | M20 | PKW 4M-*/S90/S653      | C8  |
|                        |     | PKG 6M-*               | C9  | PKW 4M-3/S90-SP        | C15 |
|                        |     | PKG 6M-*/S760          | C9  | PKW 4M-P7X2-*          | C13 |
|                        |     | PKG 6M-*/S90           | C9  | PKW 4M-P7X2-*/S90      | C13 |
|                        |     | PKG 6M-*/S90/S618      | C9  | PKW 4M-P7X2-*/S90/S101 | C13 |
|                        |     | PKG 6Z-*               | C6  | PKW 4M-P7X2-*/S90/S618 | C13 |
|                        |     | PKG 6Z-*/S760          | C6  | PKW 4Z-*               | C5  |
|                        |     | PKG 6Z-*/S90           | C6  | PKW 4Z-*/S760          | C5  |
|                        |     | PKG 6Z-*/S90/S618      | C6  | PKW 4Z-*/S90           | C5  |
|                        |     | PKG-CC                 | C31 | PKW 4Z-*/S90/S101      | C5  |
|                        |     | PKG-MC                 | C31 | PKW 4Z-*/S90/S618      | C5  |
|                        |     | PKGS 3M-*              | C10 | PKW 4Z-*/S90/S653      | C5  |
|                        |     | PKGS 3M-*/S90          | C10 | PKW 4Z-3/S90-SP        | C14 |
|                        |     | PKGS 4M-*/S90          | C10 | PKW 4Z-P7X2-*          | C11 |
|                        |     | PKW 3M-*               | C7  | PKW 4Z-P7X2-*/S90      | C11 |
|                        |     | PKW 3M-*/S1587         | C7  | PKW 4Z-P7X2-*/S90/S101 | C11 |
|                        |     | PKW 3M-*/S760          | C7  | PKW 5M PKW 5M-57x      | M19 |
|                        |     | PKW 3M-*/S90           | C7  | PKW 5M PSG 5M-57x      | M19 |
|                        |     | PKW 3M-*/S90/S101      | C7  | PKW 5M PSW 5M-57x      | M19 |
|                        |     | PKW 3M-*/S90/S1084     | C7  | PKW 5M RKT 57x*M       | M19 |
|                        |     | PKW 3M-*/S90/S618      | C7  | PKW 5M RST 57x*M       | M19 |
|                        |     | PKW 3M-3/S90-SP        | C15 | PKW 5M WKT 57x*M       | M19 |
|                        |     | PKW 3M-N7X2-*          | C12 | PKW 5M WST 57x*M       | M19 |
|                        |     | PKW 3M-N7X2-*/S90      | C12 | PKW 5M-57x             | M19 |
|                        |     | PKW 3M-N7X2-*/S90/S101 | C12 | PKW 6M-*               | C9  |
|                        |     | PKW 3M-N7X2-*/S90/S618 | C12 | PKW 6M-*/S760          | C9  |
|                        |     | PKW 3M-P7X2-*          | C12 | PKW 6M-*/S90           | C9  |
|                        |     | PKW 3M-P7X2-*/S90      | C12 | PKW 6M-*/S90/S618      | C9  |
|                        |     | PKW 3M-P7X2-*/S90/S101 | C12 | PKW 6Z-*               | C6  |
|                        |     | PKW 3M-P7X2-*/S90/S618 | C12 | PKW 6Z-*/S760          | C6  |

### P

|                    |     |                        |     |                        |     |
|--------------------|-----|------------------------|-----|------------------------|-----|
| PDP-TRA            | P12 | PKG 6M-*/S90/S618      | C9  | PKW 4M-P7X2-*/S90/S101 | C13 |
| PKG 3M-*           | C7  | PKG 6Z-*               | C6  | PKW 4M-P7X2-*/S90/S618 | C13 |
| PKG 3M-*/S1587     | C7  | PKG 6Z-*/S760          | C6  | PKW 4Z-*               | C5  |
| PKG 3M-*/S760      | C7  | PKG 6Z-*/S90           | C6  | PKW 4Z-*/S760          | C5  |
| PKG 3M-*/S90       | C7  | PKG 6Z-*/S90/S618      | C6  | PKW 4Z-*/S90           | C5  |
| PKG 3M-*/S90/S101  | C7  | PKG-CC                 | C31 | PKW 4Z-*/S90/S101      | C5  |
| PKG 3M-*/S90/S1084 | C7  | PKG-MC                 | C31 | PKW 4Z-*/S90/S618      | C5  |
| PKG 3M-*/S90/S618  | C7  | PKGS 3M-*              | C10 | PKW 4Z-*/S90/S653      | C5  |
| PKG 3M-3/S90-SP    | C15 | PKGS 3M-*/S90          | C10 | PKW 4Z-3/S90-SP        | C14 |
| PKG 3Z-*           | C4  | PKGS 4M-*/S90          | C10 | PKW 4Z-P7X2-*          | C11 |
| PKG 3Z-*/S760      | C4  | PKW 3M-*               | C7  | PKW 4Z-P7X2-*/S90      | C11 |
| PKG 3Z-*/S90       | C4  | PKW 3M-*/S1587         | C7  | PKW 4Z-P7X2-*/S90/S101 | C11 |
| PKG 3Z-*/S90/S101  | C4  | PKW 3M-*/S760          | C7  | PKW 5M PKW 5M-57x      | M19 |
| PKG 3Z-*/S90/S618  | C4  | PKW 3M-*/S90           | C7  | PKW 5M PSG 5M-57x      | M19 |
| PKG 3Z-3/S90-SP    | C14 | PKW 3M-*/S90/S101      | C7  | PKW 5M PSW 5M-57x      | M19 |
| PKG 4M-*           | C8  | PKW 3M-*/S90/S1084     | C7  | PKW 5M RKT 57x*M       | M19 |
| PKG 4M-*/S760      | C8  | PKW 3M-*/S90/S618      | C7  | PKW 5M RST 57x*M       | M19 |
| PKG 4M-*/S90       | C8  | PKW 3M-3/S90-SP        | C15 | PKW 5M WKT 57x*M       | M19 |
| PKG 4M-*/S90/S101  | C8  | PKW 3M-N7X2-*          | C12 | PKW 5M WST 57x*M       | M19 |
| PKG 4M-*/S90/S618  | C8  | PKW 3M-N7X2-*/S90      | C12 | PKW 5M-57x             | M19 |
| PKG 4M-*/S90/S653  | C8  | PKW 3M-N7X2-*/S90/S101 | C12 | PKW 6M-*               | C9  |
| PKG 4M-3/S90-SP    | C15 | PKW 3M-N7X2-*/S90/S618 | C12 | PKW 6M-*/S760          | C9  |
| PKG 4Z-*           | C5  | PKW 3M-P7X2-*          | C12 | PKW 6M-*/S90           | C9  |
| PKG 4Z-*/S760      | C5  | PKW 3M-P7X2-*/S90      | C12 | PKW 6M-*/S90/S618      | C9  |
| PKG 4Z-*/S90       | C5  | PKW 3M-P7X2-*/S90/S101 | C12 | PKW 6Z-*               | C6  |
| PKG 4Z-*/S90/S101  | C5  | PKW 3M-P7X2-*/S90/S618 | C12 | PKW 6Z-*/S760          | C6  |

# Connectivity Products

## Index

|                          |     |                          |     |                   |         |
|--------------------------|-----|--------------------------|-----|-------------------|---------|
| PKW 6Z-*/S90             | C6  | PSG 6-*/S760             | C6  | PSW 5M-57x        | M19     |
| PKW 6Z-*/S90/S618        | C6  | PSG 6-*/S90              | C6  | PSW 6-*           | C6      |
| PKWS 3M-*                | C10 | PSG 6-*/S90/S618         | C6  | PSW 6-*/S760      | C6      |
| PKWS 3M-*/S90            | C10 | PSG 6M-*                 | C9  | PSW 6-*/S90       | C6      |
| PKWS 4M-*                | C10 | PSG 6M-*/S760            | C9  | PSW 6-*/S90/S618  | C6      |
| PKWS 4M-*/S90            | C10 | PSG 6M-*/S90             | C9  | PSW 6M-*          | C9      |
| PSG 3-*                  | C4  | PSG 6M-*/S90/S618        | C9  | PSW 6M-*/S760     | C9      |
| PSG 3-*/S760             | C4  | PSG-CC                   | C31 | PSW 6M-*/S90      | C9      |
| PSG 3-*/S90              | C4  | PSG-MC                   | C31 | PSW 6M-*/S90/S618 | C9      |
| PSG 3-*/S90/S101         | C4  | PSGK-MC (8/BAG)          | C31 | PSWS 3M-*         | C10     |
| PSG 3-*/S90/S618         | C4  | PSGM-CC (8/BAG)          | C31 | PSWS 3M-*/S90     | C10     |
| PSG 3-3/S90-SP           | C14 | PSGS 3M-*                | C10 | PSWS 4M-*         | C10     |
| PSG 3F-*                 | C7  | PSGS 3M-*/S90            | C10 | PSWS 4M-*/S90     | C10     |
| PSG 3M-*                 | C7  | PSGS 4M-*                | C10 |                   |         |
| PSG 3M-*/S1587           | C7  | PSGS 4M-*/S90            | C10 |                   |         |
| PSG 3M-*/S760            | C7  | PSW 3-*                  | C4  |                   |         |
| PSG 3M-*/S90             | C7  | PSW 3-*/S760             | C4  | RB50603-*M        | M7      |
| PSG 3M-*/S90/S101        | C7  | PSW 3-*/S90              | C4  | RB50629-*M        | M7      |
| PSG 3M-*/S90/S1084       | C7  | PSW 3-*/S90/S101         | C4  | RB50633-*M        | M9      |
| PSG 3M-*/S90/S618        | C7  | PSW 3-*/S90/S618         | C4  | RB50651-*M        | M7      |
| PSG 3M-3/S90-SP          | C15 | PSW 3M-*                 | C7  | RB50652-*M        | M9      |
| PSG 4-*                  | C5  | PSW 3M-*/S1587           | C7  | RB50672-*M        | P5      |
| PSG 4-*/S760             | C5  | PSW 3M-*/S760            | C7  | RB50683-*M        | P5      |
| PSG 4-*/S90              | C5  | PSW 3M-*/S90             | C7  | RB50692-*M        | P5      |
| PSG 4-*/S90/S101         | C5  | PSW 3M-*/S90/S101        | C7  | RB50693-*M        | N6      |
| PSG 4-*/S90/S653         | C5  | PSW 3M-*/S90/S1084       | C7  | RB50708-*M        | P5      |
| PSG 4-3/S90-SP           | C14 | PSW 3M-*/S90/S618        | C7  | RB50721-*M        | M8      |
| PSG 4M-*                 | C8  | PSW 3M-3/S90-SP          | C15 | RB50764-*M        | M7, M18 |
| PSG 4M-*/S760            | C8  | PSW 3M-P7X2-*            | C12 | RB50784-*M        | N7      |
| PSG 4M-*/S90             | C8  | PSW 3M-P7X2-*/S90        | C12 | RB50785-*M        | N7      |
| PSG 4M-*/S90/S101        | C8  | PSW 3M-P7X2-*/S90/S101   | C12 | RB50785-*M        | P21     |
| PSG 4M-*/S90/S618        | C8  | PSW 4-*                  | C5  | RB50786-*M        | N7      |
| PSG 4M-*/S90/S653        | C8  | PSW 4-*/S760             | C5  | RB50786-*M        | P21     |
| PSG 4M-3/S90-SP          | C15 | PSW 4-*/S90              | C5  | RB50793-*M        | M9      |
| PSG 5 57x-*M             | M20 | PSW 4-*/S90/S101         | C5  | RB50803-*M        | N6      |
| PSG 5 PSG 5 57x-*M       | M20 | PSW 4-*/S90/S653         | C5  | RB50803-*M        | P21     |
| PSG 5 RKT 57x-*M         | M20 | PSW 4-3/S90-SP           | C14 | RB50852-*M        | R7      |
| PSG 5 RST 57x-*M         | M20 | PSW 4M-*                 | C8  | RB50860-*M        | P21     |
| PSG 5 WKT 57x-*M         | M20 | PSW 4M-*/S760            | C8  | RB50874-*M        | N6      |
| PSG 5 WST 57x-*M         | M20 | PSW 4M-*/S90             | C8  | RB50876-*M        | M8      |
| PSG 5M 57-TR             | M24 | PSW 4M-*/S90/S101        | C8  | RB50877-*M        | M8      |
| PSG 5M PSG 5M-57x        | M19 | PSW 4M-*/S90/S618        | C8  | RB50881-*M        | P5      |
| PSG 5M PSW 5M-57x        | M19 | PSW 4M-*/S90/S653        | C8  | RB50891-*M        | N7      |
| PSG 5M RKT 57x* <i>M</i> | M19 | PSW 4M-3/S90-SP          | C15 | RB50893-*M        | K5      |
| PSG 5M RST 57x* <i>M</i> | M19 | PSW 5M PSW 5M-57x        | M19 | RB50929-*M        | P21     |
| PSG 5M WKT 57x* <i>M</i> | M19 | PSW 5M RKT 57x* <i>M</i> | M19 | RB50962-*M        | R7      |
| PSG 5M WST 57x* <i>M</i> | M19 | PSW 5M RST 57x* <i>M</i> | M19 | RB50966-*M        | R7      |
| PSG 5M-57x               | M19 | PSW 5M WKT 57x* <i>M</i> | M19 | RB51029-*M        | R7      |
| PSG 6-*                  | C6  | PSW 5M WST 57x* <i>M</i> | M19 | RB51045-*M        | M18     |

## R

**Index**

|                           |     |                              |     |                       |     |
|---------------------------|-----|------------------------------|-----|-----------------------|-----|
| RB51057-*M                | P5  | RJ45MIP67 44x-*M             | K17 | RK 4.2T-*/S90         | D7  |
| RB51100-*M                | K5  | RJ45MIP67 84x-*M             | K7  | RK 4.41T-*            | D9  |
| RB51106-*M                | M9  | RJ45MIP67 FKFD 84x-*M        | K7  | RK 4.41T-*/S529       | D9  |
| RB51210-*M                | K15 | RJ45MIP67 FKFD 44x-*M        | K17 | RK 4.43T-*            | D9  |
| RB51211-*M                | K15 | RJ45MIP67 FSFD 84x-*M        | K6  | RK 4.43T-*/S90        | D9  |
| RB51212-*M                | K15 | RJ45MIP67 FSFDD 44x-*M       | K16 | RK 4.4T-*             | D9  |
| RB51213-*M                | K15 | RJ45MIP67 RJ45IP67 84x-*M    | K7  | RK 4.4T-*/S101        | D9  |
| RB51216-*M                | L3  | RJ45MIP67 RJ45MIP67 44x-*M   | K17 | RK 4.4T-*/S1587       | D10 |
| RB51225-*M                | P5  | RJ45MIP67 RJ45MIP67 84x-*M   | K7  | RK 4.4T-*/S1666       | D10 |
| RB51231-*M                | M9  | RJ45S 42x-*M                 | L5  | RK 4.4T-*/S618        | D9  |
| RB51235-*M                | M8  | RJ45S 44x-*M                 | K19 | RK 4.4T-*/S618/S824   | D9  |
| RB51240-*M                | R14 | RJ45S 84x-*M                 | K9  | RK 4.4T-*/S653        | D10 |
| RB51241-*M                | R14 | RJ45S FKSD 84x-*M            | K9  | RK 4.4T-*/S760        | D10 |
| RB51242-*M                | R14 | RJ45S FKSD 42x-*M            | L4  | RK 4.4T-*/S824        | D9  |
| RB51296-*M                | M7  | RJ45S FKSD 44x-*M            | K19 | RK 4.4T-*/S90         | D9  |
| RB51300-*M                | N7  | RJ45S FSSDE 84x-*M           | K9  | RK 4.4T-*/S90/S670    | D10 |
| RB51460-*M                | K5  | RJ45S FSSDED 42x-*M          | L4  | RK 4.4T-3.3/S90-SP    | D35 |
| RB51462-*M                | K5  | RJ45S FSSDED 44x-*M          | K19 | RK 4.4T-3/S90-SP/S669 | D35 |
| RB51463-*M                | K5  | RJ45S RJ45S 42x-*M           | L5  | RK 4.5T-*             | D11 |
| RB51604*M                 | L3  | RJ45S RJ45S 44x-*M           | K19 | RK 4.5T-*/S101        | D11 |
| RB51821-*M                | R14 | RJ45S RJ45S 84x-*M           | K9  | RK 4.5T-*/S1554       | D11 |
| RB51822-*M                | R14 | RJ45S RJ45SMIP67 42x-*M      | L5  | RK 4.5T-*/S618        | D11 |
| RB51875-*M                | R7  | RJ45S RJ45SMIP67 44x-*M      | K19 | RK 4.5T-*/S653        | D11 |
| RB51903-*M                | M8  | RJ45SMIP67 42x-*M            | L5  | RK 4.5T-*/S90         | D11 |
| RB51916-*M                | M7  | RJ45SMIP67 44x-*M            | K19 | RK 4.5T-3.3/S90-SP    | D35 |
| RJ45 44x-*M               | K17 | RJ45SMIP67 84x-*M            | K9  | RK 4.6T-*             | D12 |
| RJ45 84x-*M               | K7  | RJ45SMIP67 FKFD 84x-*M       | K19 | RK 4.6T-*/S618        | D12 |
| RJ45 FKFD 84x-*M          | K7  | RJ45SMIP67 FKSD 84x-*M       | K9  | RK 4.6T-*/S653        | D12 |
| RJ45 FKFD 44x-*M          | K17 | RJ45SMIP67 FKSD 42x-*M       | L4  | RK 4.6T-*/S90         | D12 |
| RJ45 FSFD 84x-*M          | K6  | RJ45SMIP67 FSFD 84x-*M       | K19 | RK 4.6T-*/S90/S760    | D12 |
| RJ45 FSFDD 44x-*M         | K16 | RJ45SMIP67 FSSDE 84x-*M      | K9  | RK 4T-3.3/S90-SP      | D35 |
| RJ45 RJ45 44x-*M          | K17 | RJ45SMIP67 FSSDED 42x-*M     | L4  | RK-CC                 | D95 |
| RJ45 RJ45 840-3FT/ECON    | K12 | RJ45SMIP67 RJ45S 42x-*M      | L5  | RK-MC                 | D96 |
| RJ45 RJ45 840-7FT/ECON    | K12 | RJ45SMIP67 RJ45SMIP67 42x-*M | L5  | RKA 4.4A-*            | D25 |
| RJ45 RJ45 84x-*M          | K7  | RJ45SMIP67 RJ45SMIP67 44x-*M | K19 | RKA 4.5A-*            | D25 |
| RJ45 RJ45IP67 44x-*M      | K17 | RJ45SMIP67 RJ45SMIP67 84x-*M | K9  | RKA 4A-*              | D25 |
| RJ45 RJ45IP67 84x-*M      | K7  | RJ45SMIP67 WRJ45ES 42x-*M    | L5  | RKC 10T-*             | D19 |
| RJ45 RJ45MIP67 44x-*M     | K17 | RJ45SS RJ45SMIP67 84x-*M     | K9  | RKC 10T-*/S101        | D19 |
| RJ45 RJ45MIP67 84x-*M     | K7  | RK 10T-*                     | D13 | RKC 10T-*/S618        | D19 |
| RJ45IP67 44x-*M           | K17 | RK 10T-*/S90                 | D13 | RKC 10T-*/S90         | D19 |
| RJ45IP67 84x-*M           | K7  | RK 12T-*                     | D13 | RKC 12T-*             | D20 |
| RJ45IP67 FKFD 84x-*M      | K7  | RK 12T-*/S90                 | D13 | RKC 12T-*/S618        | D20 |
| RJ45IP67 FKFD 44x-*M      | K17 | RK 4.21T-*                   | D7  | RKC 12T-*/S90         | D20 |
| RJ45IP67 FSFD 84x-*M      | K6  | RK 4.21T-*/S1511             | D7  | RKC 25x-*M            | R9  |
| RJ45IP67 FSFDD 44x-*M     | K16 | RK 4.21T-*/S90               | D7  | RKC 2RSC 25           | R12 |
| RJ45IP67 RJ45IP67 44x-*M  | K17 | RK 4.22T-*                   | D7  | RKC 4.2T-*            | D14 |
| RJ45IP67 RJ45IP67 84x-*M  | K7  | RK 4.23T-*                   | D7  | RKC 4.2T-*/CS10191    | D14 |
| RJ45IP67 RJ45MIP67 44x-*M | K17 | RK 4.2T-*                    | D7  | RKC 4.4Q-*/S849       | D44 |
| RJ45IP67 RJ45MIP67 84x-*M | K7  | RK 4.2T-*/S748               | D7  | RKC 4.4T-*            | D15 |

Index

# Connectivity Products

## Index

|                             |          |                       |     |                      |     |
|-----------------------------|----------|-----------------------|-----|----------------------|-----|
| RKC 4.4T-*/S101             | D15      | RKC RKF 57x-*M        | M13 | RKF 126-*M/M20       | F35 |
| RKC 4.4T-*/S101/S849        | D15      | RKC RSFP 25x-*M       | R9  | RKF 190-*M/14.5/NPT  | F40 |
| RKC 4.4T-*/S1587            | D15      | RKC RSFP 57x-*M       | M13 | RKF 190-*M/14.75/NPT | F40 |
| RKC 4.4T-*/S622             | D15      | RKC WKC 25x-*M        | R9  | RKF 190-*M/M20       | F41 |
| RKC 4.4T-*/S824             | D15      | RKC WKC 57x-*M        | M12 | RKF 190-*M/PG 16     | F41 |
| RKC 4.4T-*/S90              | D15      | RKC WKC 84x-*M        | K6  | RKF 20-*M            | F25 |
| RKC 4.5Q-*/S849             | D44      | RKC WRJ45E 84x-*M     | K7  | RKF 20-*M/M20        | F32 |
| RKC 4.5T-*/CS10288          | D16      | RKCD 44x-*M           | K16 | RKF 20-*M/NPT        | F29 |
| RKC 4.5T-*/S1538            | D16      | RKCD FKFD 44x-*M      | K17 | RKF 25-*M            | R16 |
| RKC 4.5T-*/S1587            | D16      | RKCD FSFD 44x-*M      | K16 | RKF 25-*M/14.5       | R15 |
| RKC 4.5T-*/S653             | D16      | RKCD RJ45 44x-*M      | K17 | RKF 25-*M/14.75      | R15 |
| RKC 4.5T-*/S715/S849        | D16      | RKCD RJ45IP67 44x-*M  | K17 | RKF 25-*M/M20        | R15 |
| RKC 4T-*                    | D14      | RKCD RJ45MIP67 44x-*M | K17 | RKF 26-*M            | F25 |
| RKC 57x-*M                  | M11, M12 | RKCD RKCD 44x-*M      | K16 | RKF 26-*M/M20        | F32 |
| RKC 6T-*                    | D17      | RKCD WRJ45E 44x-*M    | K17 | RKF 26-*M/NPT        | F29 |
| RKC 6T-*/S101               | D17      | RKCN 5T-*             | D16 | RKF 28-*M            | F25 |
| RKC 6T-*/S529               | D17      | RKCV 48x-*M           | P23 | RKF 28-*M/NPT        | F29 |
| RKC 6T-*/S618               | D17      | RKCV 49x-*M           | N9  | RKF 30-*M            | F25 |
| RKC 6T-*/S653               | D17      | RKCV FKFDV 48x-*M     | P23 | RKF 30-*M/M20        | F32 |
| RKC 6T-*/S849/S1052         | D17      | RKCV FKFDV 49x-*M     | N9  | RKF 30-*M/NPT        | F29 |
| RKC 6T-*/S90                | D17      | RKCV FSFDV 48x-*M     | P23 | RKF 31-*M            | F25 |
| RKC 6T-*/S90/S760           | D17      | RKCV FSFDV 49x-*M     | N9  | RKF 31-*M/M20        | F32 |
| RKC 6T-*S90/CS10476         | D17      | RKCV RKCV 48x-*M      | P23 | RKF 31-*M/NPT        | F29 |
| RKC 6T-3.3/S90-SP           | D37      | RKCV RKCV 49x-*M      | N9  | RKF 311-*M           | F25 |
| RKC 8.6T-*                  | D18      | RKCV RKFV 48x-*M      | P23 | RKF 311-*M/M20       | F32 |
| RKC 8.6T-3.3/S90-SP/CS10451 | D37      | RKCV RKFV 49x-*M      | N9  | RKF 311-*M/NPT       | F29 |
| RKC 8.8T-*                  | D18      | RKCV RSFPV 48x-*M     | P23 | RKF 34-*M/M20        | J4  |
| RKC 84x-*M                  | K6       | RKCV RSFPV 49x-*M     | N9  | RKF 34-*M/NPT        | J4  |
| RKC 8T-*                    | D18      | RKCV WKCV 48x-*M      | P23 | RKF 35-*M            | F25 |
| RKC 8T-*/S101               | D18      | RKCV WKCV 49x-*M      | N9  | RKF 35-*M/M20        | F32 |
| RKC 8T-*/S1555              | D18      | RKE 4.4T-*N7X2        | D29 | RKF 35-*M/NPT        | F29 |
| RKC 8T-*/S618               | D18      | RKE 4.4T-*P7X2        | D29 | RKF 36-*M            | F25 |
| RKC 8T-*/S715               | D18      | RKE 4.4T-*P7X2/S101   | D29 | RKF 36-*M/M20        | F32 |
| RKC 8T-*/S90                | D18      | RKE 4.4T-*P7X2/S90    | D29 | RKF 36-*M/NPT        | F29 |
| RKC BK52C 57x-*M            | M15      | RKE 4.5T-*P7X2        | D30 | RKF 38-*M            | F25 |
| RKC CBC5 57x-*M             | M15      | RKE 4T-*N7X2          | D28 | RKF 38-*M/NPT        | F29 |
| RKC FKFD 25x-*M             | R9       | RKE 4T-*N7X2/S715     | D28 | RKF 40-*M            | F26 |
| RKC FKFD 57x-*M             | M13      | RKE 4T-*N7X2/S824     | D28 | RKF 40-*M/M20        | F32 |
| RKC FKFD 84x-*M             | K7       | RKE 4T-*N7X2/S90      | D28 | RKF 40-*M/NPT        | F30 |
| RKC FSFD 25x-*M             | R9       | RKE 4T-*P7X2          | D28 | RKF 40-PCB           | F45 |
| RKC FSFD 57x-*M             | M13      | RKE 4T-*P7X2/S715     | D28 | RKF 44-*M/M20        | J4  |
| RKC FSFD 84x-*M             | K6       | RKE 4T-*P7X2/S824     | D28 | RKF 44-*M/NPT        | J4  |
| RKC RJ45 84x-*M             | K7       | RKE 4T-*P7X2/S90      | D28 | RKF 46-*M            | F26 |
| RKC RJ45IP67 84x-*M         | K7       | RKE 57-TR2            | M23 | RKF 46-*M/M20        | F32 |
| RKC RJ45MIP67 84x-*M        | K7       | RKF 106-*M/14.5/NPT   | F38 | RKF 46-*M/NPT        | F30 |
| RKC RKC 25x-*M              | R9       | RKF 106-*M/14.75/NPT  | F39 | RKF 48-*M            | F26 |
| RKC RKC 57x-*M              | M12      | RKF 106-*M/M20        | F35 | RKF 48A-*M/NPT       | F30 |
| RKC RKC 84x-*M              | K6       | RKF 126-*M/14.5/NPT   | F38 | RKF 50-*M            | F27 |
| RKC RKF 25x-*M              | R9       | RKF 126-*M/14.75/NPT  | F39 | RKF 50-*M/M20        | F33 |



## Index

|                      |              |                      |              |                            |          |
|----------------------|--------------|----------------------|--------------|----------------------------|----------|
| RKF 50-*M/NPT        | F31          | RKFL 26              | F46          | RKG 4.5T-*/S600            | D23      |
| RKF 50-PCB           | F45          | RKFL 36              | F46          | RKG 4.5T-*/S90/S715        | D23      |
| RKF 511-*M           | F27          | RKFL 46              | F46          | RKG 4T-*                   | D22      |
| RKF 511-*M/M20       | F33          | RKFL 56              | F46          | RKG 4T-*/S600              | D22      |
| RKF 511-*M/NPT       | F31          | RKFL 66              | F46          | RKG 6T-*                   | D23      |
| RKF 55-*M            | F27          | RKFP 20-*M           | F42          | RKG 6T-*/S90               | D23      |
| RKF 55-*M/M20        | F33          | RKFP 25x-*M          | R9           | RKG 8T-*                   | D24      |
| RKF 55-*M/NPT        | F31          | RKFP 26-*M           | F42          | RKG 8T-*/S90               | D24      |
| RKF 56-*M            | F27          | RKFP 30-*M           | F42          | RKGV-49x-*M                | N12      |
| RKF 56-*M/M20        | F33          | RKFP 31-*M           | F42          | RKK-CC                     | D96      |
| RKF 56-*M/NPT        | F31          | RKFP 311-*M          | F42          | RKL 4-*                    | D21      |
| RKF 57               | M41          | RKFP 35-*M           | F42          | RKL 4-*/S90                | D21      |
| RKF 57-*M            | M38          | RKFP 36-*M           | F42          | RKL 4.4-*                  | D21      |
| RKF 57-*M/14.5       | M37          | RKFP 40-*M           | F43          | RKL 4.4-*/S715             | D21      |
| RKF 57-*M/14.75      | M37          | RKFP 46-*M           | F43          | RKL 4.4-*/S90              | D21      |
| RKF 57-*M/M20        | M37          | RKFP 50-*M           | F44          | RKM 106-*M                 | F16      |
| RKF 57-PCB           | M41          | RKFP 511-*M          | F44          | RKM 106-*M/S101            | F16      |
| RKF 58-*M            | F27          | RKFP 55-*M           | F44          | RKM 106-*M/S1587           | F16      |
| RKF 58-*M/NPT        | F31          | RKFP 56-*M           | F44          | RKM 106-*M/S90             | F16      |
| RKF 61-*M            | F28          | RKFP 57x-*M          | M11, M13     | RKM 126-*M                 | F17      |
| RKF 61-*M/M20        | F33          | RKFP 61-*M           | F44          | RKM 126-*M/S101            | F17      |
| RKF 61-*M/NPT        | F31          | RKFP 66-*M           | F44          | RKM 126-*M/S1587           | F17      |
| RKF 66-*M            | F28          | RKFP 68-*M           | F44          | RKM 126-*M/S90             | F17      |
| RKF 66-*M/M20        | F33          | RKFP BK52C 57x-*M    | M15          | RKM 190-*M                 | F18      |
| RKF 66-*M/NPT        | F31          | RKFP CBC5 57x-*M     | M15          | RKM 190-*M/S101            | F18      |
| RKF 68-*M            | F28          | RKFPV 48x-*M         | P23          | RKM 190-*M/S760            | F18      |
| RKF 68-*M/NPT        | F31          | RKFPV 49x-*M         | N9           | RKM 190-*M/S90             | F18      |
| RKF 6B6-*M/14.5/NPT  | F36          | RKFV 48-*M           | P27          | RKM 20-*M                  | F6       |
| RKF 6B6-*M/14.75/NPT | F37          | RKFV 48-*M/14.5      | P26          | RKM 25x-*M                 | R8       |
| RKF 6B6-*M/M20       | F34          | RKFV 48-*M/14.75     | P26          | RKM 26-*M                  | F11      |
| RKF 76-*M/14.5/NPT   | F36          | RKFV 48-*M/M20       | P26          | RKM 26D-*M                 | F20      |
| RKF 76-*M/14.75/NPT  | F37          | RKFV 49-*M           | N18          | RKM 28A-*M                 | F19      |
| RKF 76-*M/M20        | F34          | RKFV 49-*M/14.5      | N17          | RKM 30-*RSM 50-RKM 30-*    | F55, F56 |
| RKF 86-*M/14.5/NPT   | F36          | RKFV 49-*M/14.75     | N17          | RKM 30-*M                  | F6       |
| RKF 86-*M/14.75/NPT  | F37          | RKFV 49-*M/M20       | N17          | RKM 30-*M/S101             | F6       |
| RKF 86-*M/M20        | F34          | RKFV-CC              | F60, J6      | RKM 30-*M/S90              | F6       |
| RKF 96-*M/14.5/NPT   | F38          | RKFV-MC              | F60, J6, S72 | RKM 30-2M/S90-SP           | F21      |
| RKF 96-*M/14.75/NPT  | F39          | RKG 10T-*            | D24          | RKM 30/SB3                 | F59      |
| RKF 96-*M/M20        | F35          | RKG 10T-*/S618       | D24          | RKM 301-*RSM 301-RKM 301-* | F55, F56 |
| RKF-CC               | F60, J6      | RKG 12T-*            | D24          | RKM 31-*M                  | F7       |
| RKF-MC               | F60, J6, S72 | RKG 12T-*/S618       | D24          | RKM 31-*M/S600             | F7       |
| RKFB-CC              | F61          | RKG 4.4T-*           | D22          | RKM 311-*M                 | F6       |
| RKFB-MC              | F61          | RKG 4.4T-*/S101      | D22          | RKM 311-*M/S600            | F6       |
| RKFBV-CC             | F61          | RKG 4.4T-*/S101/S849 | D22          | RKM 34-*M                  | J4       |
| RKFBV-MC             | F61          | RKG 4.4T-*/S1587     | D22          | RKM 34-*M/S4000            | J4       |
| RKFC-CC              | F62          | RKG 4.4T-*/S529      | D22          | RKM 35-*M                  | F11      |
| RKFC-MC              | F62          | RKG 4.4T-*/S600      | D23          | RKM 35-*M/S600             | F11      |
| RKFCV-CC             | F62          | RKG 4.4T-*/S90       | D22          | RKM 35D-*M                 | F20      |
| RKFCV-MC             | F62          | RKG 4.5T-*           | D23          | RKM 36-*M                  | F11      |

# Connectivity Products

## Index

|                         |          |                       |         |                          |          |
|-------------------------|----------|-----------------------|---------|--------------------------|----------|
| RKM 36-*M/S1587         | F11      | RKM 96-*M             | F16     | RKSD 42x-*M              | L4       |
| RKM 36D-*M              | F20      | RKM 96-*M/S101        | F16     | RKSD 44x-*M              | K18      |
| RKM 38A-*M              | F19      | RKM 96-*M/S1587       | F16     | RKSD FKSDDED 42x-*M      | L4       |
| RKM 40-*RSM 40-RKM 40-* | F55, F56 | RKM 96-*M/S90         | F16     | RKSD FKSDDED 44x-*M      | K19      |
| RKM 40-*M               | F8       | RKM BK52C 57x-*M      | M14     | RKSD FSSDED 42x-*M       | L4       |
| RKM 40-*M/S101          | F8       | RKM CBC5 57x-*M       | M14     | RKSD FSSDED 44x-*M       | K19      |
| RKM 40-*M/S529          | F8       | RKM FKFD 25x-*M       | R9      | RKSD RJ45S 42x-*M        | L5       |
| RKM 40-*M/S600          | F8       | RKM FKFD 57x-*M       | M11     | RKSD RJ45S 44x-*M        | K19      |
| RKM 40-*M/S90           | F8       | RKM FSFD 25x-*M       | R9      | RKSD RJ45SMIP67 42x-*M   | L5       |
| RKM 44-*M               | J4       | RKM FSFD 57x-*M       | M11     | RKSD RJ45SMIP67 44x-*M   | K19      |
| RKM 44-*M/S4000         | J4       | RKM RKC 25x-*M        | R9      | RKSD RKSD 42x-*M         | L4       |
| RKM 46-*M               | F12      | RKM RKC 57x-*M        | M11     | RKSD RKSD 44x-*M         | K18      |
| RKM 46-*M/S600          | F12      | RKM RKFP 25x-*M       | R9      | RKSD WKSD 44x-*M         | K18      |
| RKM 46-*M/S824          | F12      | RKM RKFP 57x-*M       | M11     | RKSD WRJ45ES 42x-*M      | L5       |
| RKM 46D-*M              | F20      | RKM RKM 25            | R13     | RKSD WRJ45ES 44x-*M      | K19      |
| RKM 47-*M               | F12      | RKM RKM 25x-*M        | R8      | RKSS FSSDE 84x-*M        | K9       |
| RKM 48A-*M              | F19      | RKM RKM 57            | M35     | RKSW 2RSSW 45/CM         | P16      |
| RKM 50-*M               | F9       | RKM RKM 57-0/VM       | M29     | RKSW 45-TR               | P12      |
| RKM 50-*M/S101          | F9       | RKM RKM 57x-*M        | M10     | RKSW 45x-*M              | P6       |
| RKM 50-*M/S1551         | F9       | RKM RSC 25x-*M        | R8      | RKSW D9S RKSW 45x-*M-*M  | P9       |
| RKM 50-*M/S90           | F9       | RKM RSC 57x-*M        | M10     | RKSW D9S/T 45x-*M        | P8       |
| RKM 50-1M/S90-SP        | F21      | RKM RSFP 25x-*M       | R9      | RKSW D9SM RKSW 45x-*M-*M | P9       |
| RKM 511-*M              | F9       | RKM RSFP 57x-*M       | M11     | RKSW D9SM/T 45x-*M       | P8       |
| RKM 511-*M/S600         | F9       | RKM WKC 25x-*M        | R9      | RKSW RKSW 45x-*M         | P6       |
| RKM 55-*M               | F13      | RKM WKC 57x-*M        | M11     | RKSW SD9S RKSW 45x-*M-*M | P9       |
| RKM 55-*M/S600          | F13      | RKM WKM 25x-*M        | R8      | RKSW SD9S/T 45x-*M       | P8       |
| RKM 56-*M               | F13      | RKM WKM 57x-*M        | M10     | RKSW WKSW 45x-*M         | P6       |
| RKM 56-*M/S1587         | F13      | RKM WSC 25x-*M        | R9      | RKT 57x-*                | M19, M20 |
| RKM 56D-*M              | F20      | RKM WSC 57x-*M        | M11     | RKV 48x-*M               | P22      |
| RKM 57-TR2              | M23      | RKM-CC                | F60, J6 | RKV 49x-*M               | N8       |
| RKM 57x-*M              | M10      | RKMB-CC               | F61     | RKV FKFDV 48x-*M         | P23      |
| RKM 58A-*M              | F19      | RKMBV-CC              | F61     | RKV FKFDV 49x-*M         | N9       |
| RKM 61-*M               | F10      | RKMC-CC               | F62     | RKV FSFDV 48x-*M         | P23      |
| RKM 61-*M/S739          | F10      | RKMCV-CC              | F62     | RKV FSFDV 49x-*M         | N9       |
| RKM 61-*M/S763          | F10      | RKMV-CC               | F60, J6 | RKV RKCVC 48x-*M         | P23      |
| RKM 66-*M               | F13      | RKS 10T-*             | D27     | RKV RKCVC 49x-*M         | N9       |
| RKM 66-*M/S1587         | F13      | RKS 12T-*             | D27     | RKV RKFPV 48x-*M         | P23      |
| RKM 68A-*M              | F19      | RKS 4.4T-*            | D26     | RKV RKFPV 49x-*M         | N9       |
| RKM 6B6-*M              | F14      | RKS 4.4T-*/S824       | D26     | RKV RKV 48               | P32      |
| RKM 6B6-*M/S101         | F14      | RKS 4.4T-*/S90        | D26     | RKV RKV 48x-*M           | P22      |
| RKM 6B6-*M/S90          | F14      | RKS 4.5T-*            | D26     | RKV RKV 49               | N14      |
| RKM 76-*M               | F14      | RKS 6T-*              | D26     | RKV RKV 49x-*M           | N8       |
| RKM 76-*M/S101          | F14      | RKS 84x-*M            | K8      | RKV RSCV 48x-*M          | P22      |
| RKM 76-*M/S1587         | F14      | RKS 8T-*              | D27     | RKV RSCV 49x-*M          | N8       |
| RKM 76-*M/S90           | F14      | RKS FKSDE 84-*M       | K9      | RKV RSFPV 48x-*M         | P23      |
| RKM 86-*M               | F15      | RKS RJ45S 84x-*M      | K9      | RKV RSFPV 49x-*M         | N9       |
| RKM 86-*M/S101          | F15      | RKS RJ45SMIP67 84x-*M | K9      | RKV WKCV 48x-*M          | P23      |
| RKM 86-*M/S1587         | F15      | RKS RKS 84x-*M        | K8      | RKV WKCV 49x-*M          | N9       |
| RKM 86-*M/S90           | F15      | RKS WRJ45ES 84x-*M    | K9      | RKV WKV 48x-*M           | P22      |

**Index**

|                       |     |                      |          |                             |     |
|-----------------------|-----|----------------------|----------|-----------------------------|-----|
| RKV WKV 49x-*M        | N8  | RS 4T-*/S529         | D8       | RSC 6T-*/S90/S760           | D17 |
| RKV WSCV 48x-*M       | P23 | RS 4T-*/S618         | D8       | RSC 6T-3.3/S90-SP           | D38 |
| RKV WSCV 49x-*M       | N9  | RS 4T-*/S715         | D8       | RSC 8.6T-*                  | D18 |
| RKV-CC                | D95 | RS 4T-*/S760         | D8       | RSC 8.6T-3.3/S90-SP/CS10451 | D38 |
| RKV-MC                | D96 | RS 4T-*/S824         | D8       | RSC 8.8T-*                  | D18 |
| RS 10T-*              | D13 | RS 4T-*/S90          | D8       | RSC 84x-*M                  | K6  |
| RS 10T-*/S90          | D13 | RS 4T-3.3/S90-SP     | D36      | RSC 8T-*                    | D18 |
| RS 12T-*              | D13 | RS-CC                | D95      | RSC 8T-*/S101               | D18 |
| RS 12T-*/S90          | D13 | RS-MC                | D96      | RSC 8T-*/S1555              | D18 |
| RS 4.21T-*            | D7  | RSA 4.4A-*           | D25      | RSC 8T-*/S618               | D18 |
| RS 4.21T-*/S1511      | D7  | RSA 4.5A-*           | D25      | RSC 8T-*/S715               | D18 |
| RS 4.21T-*/S90        | D7  | RSA 4A-*             | D25      | RSC 8T-*/S90                | D18 |
| RS 4.22T-*            | D7  | RSC 10T-*            | D19      | RSC 8VBRK RKC 5724-DCL      | M47 |
| RS 4.23T-*            | D7  | RSC 10T-*/S101       | D19      | RSC BK52C 57x-*M            | M14 |
| RS 4.2T-*             | D7  | RSC 10T-*/S618       | D19      | RSC CBC5 57x-*M             | M14 |
| RS 4.2T-*/S748        | D7  | RSC 10T-*/S90        | D19      | RSC FKFD 25x-*M             | R9  |
| RS 4.2T-*/S90         | D7  | RSC 12T-*            | D20      | RSC FKFD 84x-*M             | K7  |
| RS 4.41T-*            | D9  | RSC 12T-*/S101       | D20      | RSC FSFD 25x-*M             | R9  |
| RS 4.41T-*/S529       | D9  | RSC 12T-*/S618       | D20      | RSC FSFD 57x-*M             | M13 |
| RS 4.43T-*            | D9  | RSC 12T-*/S90        | D20      | RSC FSFD 84x-*M             | K6  |
| RS 4.43T-*/S90        | D9  | RSC 25x-*M           | R8       | RSC RJ45 84x-*M             | K7  |
| RS 4.4T-*             | D9  | RSC 2RKC 57          | M34      | RSC RJ45IP67 84x-*M         | K7  |
| RS 4.4T-*/S101        | D9  | RSC 2RKC 57/KS       | M34      | RSC RJ45MIP67 84x-*M        | K7  |
| RS 4.4T-*/S1587       | D10 | RSC 4.2T-*           | D14      | RSC RKC 25                  | R12 |
| RS 4.4T-*/S1666       | D10 | RSC 4.2T-*/CS10191   | D14      | RSC RKC 25x-*M              | R9  |
| RS 4.4T-*/S618        | D9  | RSC 4.4Q-*/S849      | D44      | RSC RKC 57                  | M36 |
| RS 4.4T-*/S618/S824   | D9  | RSC 4.4T-*           | D15      | RSC RKC 572-*M/RKC 57       | M34 |
| RS 4.4T-*/S653        | D10 | RSC 4.4T-*/S101      | D15      | RSC RKC 84x-*M              | K6  |
| RS 4.4T-*/S760        | D10 | RSC 4.4T-*/S101/S849 | D15      | RSC RKFP 25x-*M             | R9  |
| RS 4.4T-*/S824        | D9  | RSC 4.4T-*/S1587     | D15      | RSC RKFP 57x-*M             | M13 |
| RS 4.4T-*/S90         | D9  | RSC 4.4T-*/S622      | D15      | RSC RSC 25x-*M              | R8  |
| RS 4.4T-*/S90/S670    | D10 | RSC 4.4T-*/S824      | D15      | RSC RSC 57x-*M              | M12 |
| RS 4.4T-3.3/S90-SP    | D36 | RSC 4.4T-*/S90       | D15      | RSC RSC 84x-*M              | K6  |
| RS 4.4T-3/S90-SP/S669 | D36 | RSC 4.5Q-*/S849      | D44      | RSC RSFP 25x-*M             | R9  |
| RS 4.5T-*             | D11 | RSC 4.5T-*/CS10288   | D16      | RSC RSFP 57x-*M             | M13 |
| RS 4.5T-*/S101        | D11 | RSC 4.5T-*/S1538     | D16      | RSC WKC 25x-*M              | R9  |
| RS 4.5T-*/S1554       | D11 | RSC 4.5T-*/S1587     | D16      | RSC WKC 57                  | M36 |
| RS 4.5T-*/S618        | D11 | RSC 4.5T-*/S653      | D16      | RSC WKC 57x-*M              | M12 |
| RS 4.5T-*/S653        | D11 | RSC 4.5T-*/S715/S849 | D16      | RSC WKC 84x-*M              | K6  |
| RS 4.5T-*/S715        | D11 | RSC 4T-*             | D14      | RSC WRJ45E 84x-*M           | K7  |
| RS 4.5T-*/S90         | D11 | RSC 57x-*M           | M10, M12 | RSC WSC 25x-*M              | R9  |
| RS 4.5T-3.3/S90-SP    | D36 | RSC 6T-*             | D17      | RSC WSC 57x-*M              | M12 |
| RS 4.6T-*             | D12 | RSC 6T-*/S101        | D17      | RSC WSC 84x-*M              | K6  |
| RS 4.6T-*/S618        | D12 | RSC 6T-*/S529        | D17      | RSCD 44x-*M                 | K16 |
| RS 4.6T-*/S653        | D12 | RSC 6T-*/S618        | D17      | RSCD FKFD 44x-*M            | K17 |
| RS 4.6T-*/S90         | D12 | RSC 6T-*/S653        | D17      | RSCD FSFD 44x-*M            | K16 |
| RS 4.6T-*/S90/S760    | D12 | RSC 6T-*/S849/S1052  | D17      | RSCD RJ45 44x-*M            | K17 |
| RS 4T-*               | D8  | RSC 6T-*/S90         | D17      | RSCD RJ45IP67 44x-*M        | K17 |
| RS 4T-*/S101          | D8  | RSC 6T-*/S90/CS10476 | D17      | RSCD RJ45MIP67 44x-*M       | K17 |

Index

# Connectivity Products

## Index

|                      |     |                  |     |                      |              |
|----------------------|-----|------------------|-----|----------------------|--------------|
| RSCD RKCD 44x-*M     | K16 | RSF 190-*M/PG 16 | F41 | RSF 511-*M/NPT       | F31          |
| RSCD RSCD 44x-*M     | K16 | RSF 20-*M        | F25 | RSF 55-*M            | F27          |
| RSCD WKCD 44x-*M     | K16 | RSF 20-*M/M20    | F32 | RSF 55-*M/M20        | F33          |
| RSCD WRJ45E 44x-*M   | K17 | RSF 20-*M/NPT    | F29 | RSF 55-*M/NPT        | F31          |
| RSCD WSCD 44x-*M     | K16 | RSF 25-*M        | R16 | RSF 56-*M            | F27          |
| RSCN 5T-*            | D16 | RSF 25-*M/14.5   | R15 | RSF 56-*M/M20        | F33          |
| RSCV 2RKCV 25        | R12 | RSF 25-*M/14.75  | R15 | RSF 56-*M/NPT        | F31          |
| RSCV 2RKCV 49        | N13 | RSF 25-*M/M20    | R15 | RSF 57               | M41          |
| RSCV 48x-*M          | P22 | RSF 26-*M        | F25 | RSF 57-*M            | M38          |
| RSCV 49x-*M          | N8  | RSF 26-*M/M20    | F32 | RSF 57-*M/14.5       | M37          |
| RSCV FKFDV 48x-*M    | P23 | RSF 26-*M/NPT    | F29 | RSF 57-*M/14.75      | M37          |
| RSCV FKFDV 49x-*M    | N9  | RSF 28-*M        | F25 | RSF 57-*M/M20        | M37          |
| RSCV FSFDV 48x-*M    | P23 | RSF 28-*M/NPT    | F29 | RSF 57-PCB           | M41          |
| RSCV FSFDV 49x-*M    | N9  | RSF 30-*M        | F25 | RSF 58-*M            | F27          |
| RSCV RKCVC 48x-*M    | P23 | RSF 30-*M/M20    | F32 | RSF 58-*M/NPT        | F31          |
| RSCV RKCVC 49        | N13 | RSF 30-*M/NPT    | F29 | RSF 61-*M            | F28          |
| RSCV RKCVC 49x-*M    | N9  | RSF 31-*M        | F25 | RSF 61-*M/M20        | F33          |
| RSCV RKFPV 48x-*M    | P23 | RSF 31-*M/M20    | F32 | RSF 61-*M/NPT        | F31          |
| RSCV RKFPV 49x-*M    | N9  | RSF 31-*M/NPT    | F29 | RSF 66-*M            | F28          |
| RSCV RSCV 48x-*M     | P22 | RSF 311-*M       | F25 | RSF 66-*M/M20        | F33          |
| RSCV RSCV 49x-*M     | N8  | RSF 311-*M/M20   | F32 | RSF 66-*M/NPT        | F31          |
| RSCV RSFPV 48x-*M    | P23 | RSF 311-*M/NPT   | F29 | RSF 68-*M            | F28          |
| RSCV RSFPV 49x-*M    | N9  | RSF 34-*M/M20    | J4  | RSF 68-*M/NPT        | F31          |
| RSCV WKCV 25         | R12 | RSF 34-*M/NPT    | J4  | RSF 6B6-*M/14.5/NPT  | F36          |
| RSCV WKCV 48x-*M     | P23 | RSF 35-*M        | F25 | RSF 6B6-*M/14.75/NPT | F37          |
| RSCV WKCV 49         | N13 | RSF 35-*M/M20    | F32 | RSF 6B6-*M/M20       | F34          |
| RSCV WKCV 49x-*M     | N9  | RSF 35-*M/NPT    | F29 | RSF 76-*M/14.5/NPT   | F36          |
| RSCV WSCV 48x-*M     | P23 | RSF 36-*M        | F25 | RSF 76-*M/14.75/NPT  | F37          |
| RSCV WSCV 49x-*M     | N9  | RSF 36-*M/M20    | F32 | RSF 76-*M/M20        | F34          |
| RSE 4.4T-*N7X2       | D29 | RSF 36-*M/NPT    | F29 | RSF 86-*M/14.5/NPT   | F36          |
| RSE 4.4T-*P7X2       | D29 | RSF 38-*M        | F25 | RSF 86-*M/14.75/NPT  | F37          |
| RSE 4.4T-*P7X2/S101  | D29 | RSF 38-*M/NPT    | F29 | RSF 86-*M/M20        | F34          |
| RSE 4.4T-*P7X2/S90   | D29 | RSF 40-*M        | F26 | RSF 96-*M/14.5/NPT   | F38          |
| RSE 4T-*P7X2         | D28 | RSF 40-*M/M20    | F32 | RSF 96-*M/14.75/NPT  | F39          |
| RSE 4T-*P7X2/S715    | D28 | RSF 40-*M/NPT    | F30 | RSF 96-*M/M20        | F35          |
| RSE 4T-*P7X2/S824    | D28 | RSF 40-PCB       | F45 | RSF RKF 20/22        | F47          |
| RSE 4T-*P7X2/S90     | D28 | RSF 44-*M/M20    | J4  | RSF RKF 30/22        | F47          |
| RSE 57-TR2           | M23 | RSF 44-*M/NPT    | J4  | RSF RKF 34/DS        | J7           |
| RSE 57-TR2/VM        | M23 | RSF 46-*M        | F26 | RSF RKF 34/DS/AUX    | J7           |
| RSEV 49-TR           | N12 | RSF 46-*M/M20    | F32 | RSF RKF 40/22        | F47          |
| RSF 106-*M/14.5/NPT  | F38 | RSF 46-*M/NPT    | F30 | RSF RKF 44/DS        | J7           |
| RSF 106-*M/14.75/NPT | F39 | RSF 48-*M        | F26 | RSF RKF 44/DS/AUX    | J7           |
| RSF 106-*M/M20       | F35 | RSF 48A-*M/NPT   | F30 | RSF RKF 50/22        | F47          |
| RSF 126-*M/14.5/NPT  | F38 | RSF 50-*M        | F27 | RSF RKF 57/22        | M25          |
| RSF 126-*M/14.75/NPT | F39 | RSF 50-*M/M20    | F33 | RSF RKF 60/22        | F47          |
| RSF 126-*M/M20       | F35 | RSF 50-*M/NPT    | F31 | RSF-CC               | F60, J6      |
| RSF 190-*M/14.5/NPT  | F40 | RSF 50-PCB       | F45 | RSF-MC               | F60, J6, S72 |
| RSF 190-*M/14.75/NPT | F40 | RSF 511-*M       | F27 | RSFB-CC              | F61          |
| RSF 190-*M/M20       | F41 | RSF 511-*M/M20   | F33 | RSFB-MC              | F61          |

## Index

|                   |              |                      |          |                  |          |
|-------------------|--------------|----------------------|----------|------------------|----------|
| RSFBV-CC          | F61          | RSG 4.4T-*           | D22      | RSM 31-*M/S600   | F7       |
| RSFBV-MC          | F61          | RSG 4.4T-*/S101      | D22      | RSM 311-*M       | F6       |
| RSFC-CC           | F62          | RSG 4.4T-*/S101/S849 | D22      | RSM 311-*M/S600  | F6       |
| RSFC-MC           | F62          | RSG 4.4T-*/S1587     | D22      | RSM 34-*M        | J4       |
| RSFCV-CC          | F62          | RSG 4.4T-*/S529      | D22      | RSM 34-*M/S4000  | J4       |
| RSFCV-MC          | F62          | RSG 4.4T-*/S600      | D23      | RSM 35-*M        | F11      |
| RSFK-MC           | S72          | RSG 4.4T-*/S90       | D22      | RSM 35-*M/S600   | F11      |
| RSFL 26           | F46          | RSG 4.5T-*           | D23      | RSM 35D-*M       | F20      |
| RSFL 36           | F46          | RSG 4.5T-*/S600      | D23      | RSM 36-*M        | F11      |
| RSFL 46           | F46          | RSG 4.5T-*/S90/S715  | D23      | RSM 36-*M/S1587  | F11      |
| RSFL 56           | F46          | RSG 4T-*             | D22      | RSM 36D-*M       | F20      |
| RSFL 66           | F46          | RSG 4T-*/S600        | D22      | RSM 38A-*M       | F19      |
| RSFP 20-*M        | F42          | RSG 6T-*             | D23      | RSM 40-*M        | F8       |
| RSFP 25x-*M       | R9           | RSG 6T-*/S90         | D23      | RSM 40-*M/S101   | F8       |
| RSFP 26-*M        | F42          | RSG 8T-*             | D24      | RSM 40-*M/S529   | F8       |
| RSFP 30-*M        | F42          | RSG 8T-*/S90         | D24      | RSM 40-*M/S600   | F8       |
| RSFP 31-*M        | F42          | RSGV-49x-*M          | N12      | RSM 40-*M/S90    | F8       |
| RSFP 311-*M       | F42          | RSK-CC               | D96      | RSM 40-FK 4.4    | D93, F59 |
| RSFP 35-*M        | F42          | RSL 4-*              | D21      | RSM 44-*M        | J4       |
| RSFP 36-*M        | F42          | RSL 4-*/S90          | D21      | RSM 44-*M/S4000  | J4       |
| RSFP 40-*M        | F43          | RSL 4.4-*            | D21      | RSM 46-*M        | F12      |
| RSFP 46-*M        | F43          | RSL 4.4-*/S715       | D21      | RSM 46-*M/S600   | F12      |
| RSFP 50-*M        | F44          | RSL 4.4-*/S90        | D21      | RSM 46-*M/S824   | F12      |
| RSFP 511-*M       | F44          | RSM 106-*M           | F16      | RSM 46D-*M       | F20      |
| RSFP 55-*M        | F44          | RSM 106-*M/S101      | F16      | RSM 47-*M        | F12      |
| RSFP 56-*M        | F44          | RSM 106-*M/S1587     | F16      | RSM 48-FK 4.4    | P32      |
| RSFP 57x-*M       | M11, M13     | RSM 106-*M/S90       | F16      | RSM 48A-*M       | F19      |
| RSFP 61-*M        | F44          | RSM 126-*M           | F17      | RSM 49-FK 4.4    | N21      |
| RSFP 66-*M        | F44          | RSM 126-*M/S101      | F17      | RSM 50-*M        | F9       |
| RSFP 68-*M        | F44          | RSM 126-*M/S1587     | F17      | RSM 50-*M/S101   | F9       |
| RSFP BK52C 57x-*M | M15          | RSM 126-*M/S90       | F17      | RSM 50-*M/S1551  | F9       |
| RSFP CBC5 57x-*M  | M15          | RSM 190-*M           | F18      | RSM 50-*M/S90    | F9       |
| RSFPV 48x-*M      | P23          | RSM 190-*M/S101      | F18      | RSM 50-1M/S90-SP | F21      |
| RSFPV 49x-*M      | N9           | RSM 190-*M/S760      | F18      | RSM 50-2RKM 30   | F53      |
| RSFV 48-*M        | P27          | RSM 190-*M/S90       | F18      | RSM 50-FK 4.5    | D93, F59 |
| RSFV 48-*M/14.5   | P26          | RSM 20-*M            | F6       | RSM 511-*M       | F9       |
| RSFV 48-*M/14.75  | P26          | RSM 25-FK 4.5        | R21      | RSM 511-*M/S600  | F9       |
| RSFV 48-*M/M20    | P26          | RSM 25x-*M           | R8       | RSM 55-*M        | F13      |
| RSFV 49-*M        | N18          | RSM 26-*M            | F11      | RSM 55-*M/S600   | F13      |
| RSFV 49-*M/14.5   | N17          | RSM 26D-*M           | F20      | RSM 56-*M        | F13      |
| RSFV 49-*M/14.75  | N17          | RSM 28A-*M           | F19      | RSM 56-*M/S1587  | F13      |
| RSFV 49-*M/M20    | N17          | RSM 2RKM 57-KF       | M28      | RSM 56D-*M       | F20      |
| RSFV RKFV 49/22   | N16          | RSM 2RKM 57-KM       | M28      | RSM 57-FK 4.5    | M36      |
| RSFV-CC           | F60, J6      | RSM 30-*M            | F6       | RSM 57-TR2       | M23      |
| RSFV-MC           | F60, J6, S72 | RSM 30-*M/S101       | F6       | RSM 57-TR2/VM    | M23      |
| RSG 10T-*         | D24          | RSM 30-*M/S90        | F6       | RSM 57x-*M       | M10      |
| RSG 10T-*/S618    | D24          | RSM 30-2M/S90-SP     | F21      | RSM 58A-*M       | F19      |
| RSG 12T-*         | D24          | RSM 30-J23           | S66, S72 | RSM 61-*M        | F10      |
| RSG 12T-*/S618    | D24          | RSM 31-*M            | F7       | RSM 61-*M/S739   | F10      |

# Connectivity Products

## Index

|                       |     |                        |         |                          |          |
|-----------------------|-----|------------------------|---------|--------------------------|----------|
| RSM 61-*M/S763        | F10 | RSM WSC 57x-*M         | M11     | RSSD RSSD 42x-*M         | L4       |
| RSM 66-*M             | F13 | RSM WSM 25x-*M         | R8      | RSSD RSSD 44x-*M         | K18      |
| RSM 66-*M/S1587       | F13 | RSM WSM 57x-*M         | M10     | RSSD WKSD 44x-*M         | K18      |
| RSM 68A-*M            | F19 | RSM-2RKM 20            | F53     | RSSD WRJ45ES 42x-*M      | L5       |
| RSM 6B6-*M            | F14 | RSM-2RKM 30            | F53     | RSSD WRJ45ES 44x-*M      | K19      |
| RSM 6B6-*M/S101       | F14 | RSM-2RKM 30-KF         | F54     | RSSD WSSD 44x-*M         | K18      |
| RSM 6B6-*M/S90        | F14 | RSM-2RKM 30-KM         | F54     | RSSW 45-TR               | P12      |
| RSM 76-*M             | F14 | RSM-2RKM 40            | F53     | RSSW 45x-*M              | P6       |
| RSM 76-*M/S101        | F14 | RSM-2RKM 40 KM         | F54     | RSSW D9S RKSX 45x-*M-*M  | P9       |
| RSM 76-*M/S1587       | F14 | RSM-2RKM 40-KF         | F54     | RSSW D9S RSSW 45x-*M-*M  | P9       |
| RSM 76-*M/S90         | F14 | RSM-2RKM 50            | F53     | RSSW D9S/T 45x-*M        | P8       |
| RSM 86-*M             | F15 | RSM-2RKM 57            | M28     | RSSW D9SM RKSX 45x-*M-*M | P9       |
| RSM 86-*M/S101        | F15 | RSM-2RKM 57 DGT        | M32     | RSSW D9SM RSSW 45x-*M    | P9       |
| RSM 86-*M/S1587       | F15 | RSM-CC                 | F60, J6 | RSSW D9SM/T 45x-*M       | P8       |
| RSM 86-*M/S90         | F15 | RSMB-CC                | F61     | RSSW RKSX 45x-*M         | P6       |
| RSM 96-*M             | F16 | RSMBV-CC               | F61     | RSSW RSSW 45x-*M         | P6       |
| RSM 96-*M/S101        | F16 | RSMC-CC                | F62     | RSSW SD9S RKSX 45x-*M-*M | P9       |
| RSM 96-*M/S1587       | F16 | RSMCV-CC               | F62     | RSSW SD9S RSSW 45x-*M-*M | P9       |
| RSM 96-*M/S90         | F16 | RSMV-CC                | F60, J6 | RSSW SD9S/T 45x-*M       | P8       |
| RSM BK52C 57x-*M      | M14 | RSS 10T-*              | D27     | RSSW WKSX 45x-*M         | P6       |
| RSM CBC5 57x-*M       | M14 | RSS 12T-*              | D27     | RSSW WSSW 45x-*M         | P6       |
| RSM FKFD 25x-*M       | R9  | RSS 4.4T-*             | D26     | RST 57x-*                | M19, M20 |
| RSM FKFD 57x-*M       | M11 | RSS 4.4T-*/S824        | D26     | RSV 2RKV 25              | R12      |
| RSM FKM RKM 57        | M33 | RSS 4.4T-*/S90         | D26     | RSV 48x-*M               | P22      |
| RSM FSFD 25x-*M       | R9  | RSS 4.5T-*             | D26     | RSV 49-TR                | N12      |
| RSM FSFD 57x-*M       | M11 | RSS 6T-*               | D26     | RSV 49x-*M               | N8       |
| RSM RKC 25x-*M        | R9  | RSS 84x-*M             | K8      | RSV FKFDV 48x-*M         | P23      |
| RSM RKC 57x-*M        | M11 | RSS 8T-*               | D27     | RSV FKFDV 49x-*M         | N9       |
| RSM RKC 57x-*M-RKM 57 | M33 | RSS FKSD 84x-*M        | K9      | RSV FKV RKV 49           | N13      |
| RSM RKFP 25x-*M       | R9  | RSS FSSDE 84x-*M       | K9      | RSV FSFDV 48x-*M         | P23      |
| RSM RKFP 57x-*M       | M11 | RSS RJ45S 84x-*M       | K9      | RSV FSFDV 49x-*M         | N9       |
| RSM RKM 25x-*M        | R8  | RSS RJ45SMIP67 84x-*M  | K9      | RSV RKCX 48x-*M          | P23      |
| RSM RKM 57 WSM 40 PST | M32 | RSS RKS 84x-*M         | K8      | RSV RKCX 49x-*M          | N9       |
| RSM RKM 57-0/VM       | M29 | RSS RSS 84x-*M         | K8      | RSV RKFPV 48x-*M         | P23      |
| RSM RKM 57x-*M        | M10 | RSS WKS 84x-*M         | K8      | RSV RKFPV 49x-*M         | N9       |
| RSM RSC 25x-*M        | R8  | RSS WRJ45ES 84x-*M     | K9      | RSV RKV 48x-*M           | P22      |
| RSM RSC 57x-*M        | M10 | RSS WSS 84x-*M         | K8      | RSV RKV 49 SS            | N15      |
| RSM RSFP 25x-*M       | R9  | RSSD 42x-*M            | L4      | RSV RKV 49x-*M           | N8       |
| RSM RSFP 57x-*M       | M11 | RSSD 44x-*M            | K18     | RSV RSCV 48x-*M          | P22      |
| RSM RSM 25x-*M        | R8  | RSSD FKSD 42x-*M       | L4      | RSV RSCV 49x-*M          | N8       |
| RSM RSM 57            | M35 | RSSD FKSD 44x-*M       | K19     | RSV RSFPV 48x-*M         | P23      |
| RSM RSM 57-0          | M31 | RSSD FSSDED 42x-*M     | L4      | RSV RSFPV 49x-*M         | N9       |
| RSM RSM 57-0/VM       | M29 | RSSD FSSDED 44x-*M     | K19     | RSV RSV 48x-*M           | P22      |
| RSM RSM 57x-*M        | M10 | RSSD RJ45S 42x-*M      | L5      | RSV RSV 49               | N14      |
| RSM WKC 25x-*M        | R9  | RSSD RJ45S 44x-*M      | K19     | RSV RSV 49x-*M           | N8       |
| RSM WKC 57x-*M        | M11 | RSSD RJ45SMIP67 42x-*M | L5      | RSV WKCV 48x-*M          | P23      |
| RSM WKM 25x-*M        | R8  | RSSD RJ45SMIP67 44x-*M | K19     | RSV WKCV 49x-*M          | N9       |
| RSM WKM 57x-*M        | M10 | RSSD RKSD 42x-*M       | L4      | RSV WKV 48x-*M           | P22      |
| RSM WSC 25x-*M        | R9  | RSSD RKSD 44x-*M       | K18     | RSV WKV 49x-*M           | N8       |

**Index**

|                 |     |                             |     |                             |     |
|-----------------|-----|-----------------------------|-----|-----------------------------|-----|
| RSV WSCV 48x-*M | P23 | SH-BSM/2BKM 22-380-*/*/*    | J34 | ST ID 3/4-INCH (10/BAG-6IN) | U9  |
| RSV WSCV 49x-*M | N9  | SH-BSM/2BKM 34              | J34 | ST ID 3/4-INCH-30M          | U9  |
| RSV WSV 48x-*M  | P22 | SH-BSM/2BKM 34-198-*        | J34 | ST ID 3/8-INCH (10/BAG-6IN) | U9  |
| RSV WSV 49x-*M  | N8  | SH-BSM/2BKM 34-198-*/*/*    | J34 | ST ID 3/8-INCH-30M          | U9  |
| RSV-2RKV 49     | N13 | SH-BSM/2BKM 44              | J34 |                             |     |
| RSV-CC          | D95 | SH-BSM/2BKM 44-193-*        | J34 | <b>T</b>                    |     |
| RSV-MC          | D96 | SH-BSM/2BKM 44-193-*/*/*    | J34 |                             |     |
|                 |     | SH-BSM/BKM/T22-380-*        | J34 | TC8S 2-A587-*M-PSG 3        | T28 |
|                 |     | SH-BSM/BKM/T34-198-*        | J34 | TC8S 2-A587-*M-PSG 3M       | T28 |
|                 |     | SH-BSM/BKM/T44-193-*        | J34 | TC8S 2-A642-*M-PSG 3        | T28 |
|                 |     | SH-GSDM/2GKDM 30            | J18 | TC8S 2-A642-*M-PSG 3M       | T28 |
|                 |     | SH-GSDM/2GKDM 30-*          | J18 | TC8S 2-A653-*M              | T26 |
|                 |     | SH-GSDM/2GKDM 30-*/S4000    | J18 | TC8S 2-A653-*M-RS 5.3T      | T28 |
|                 |     | SH-GSDM/2GKDM 32-*          | J18 | TC8S 2-A653-*M-RSM 30       | T30 |
|                 |     | SH-GSDM/2GKDM 32-*/S4000    | J18 | TC8S 2-A653-*M-SB 3T        | T30 |
|                 |     | SH-GSDM/2GKDM 34-*          | J18 | TC8S 2-A669-*M              | T26 |
|                 |     | SH-GSDM/2GKDM 34-*/S4000    | J18 | TC8S 2-A669-*M-RS 5.3T      | T28 |
|                 |     | SH-GSDM/2GKDM 40            | J18 | TC8S 2-A669-*M-RSM 30       | T30 |
|                 |     | SH-GSDM/2GKDM 40-*          | J18 | TC8S 2-A669-*M-SB 3T        | T30 |
|                 |     | SH-GSDM/2GKDM 40-*/S4000    | J18 | TC8S 2-AW                   | T42 |
|                 |     | SH-GSDM/2GKDM 42-*          | J18 | TC8S 2-L587-*M              | T26 |
|                 |     | SH-GSDM/2GKDM 42-*/S4000    | J18 | TC8S 2-L587-*M-PSG 3        | T28 |
|                 |     | SH-GSDM/2GKDM 44-*          | J18 | TC8S 2-L587-*M-PSG 3M       | T28 |
|                 |     | SH-GSDM/2GKDM 44-*/S4000    | J18 | TC8S 2-L642-*M              | T26 |
|                 |     | SH-GSDM/GKDM/BKM 34         | J18 | TC8S 2-L642-*M-PSG 3        | T28 |
|                 |     | SH-GSDM/GKDM/BKM 34-*/S4000 | J18 | TC8S 2-L642-*M-PSG 3M       | T28 |
|                 |     | SH-GSDM/GKDM/BKM 44         | J18 | TC8S 2-L653-*M              | T26 |
|                 |     | SH-GSDM/GKDM/BKM 44-*/S4000 | J18 | TC8S 2-L653-*M-RS 5.3T      | T28 |
|                 |     | SH-GSDM/GKDM/RKM 34-*       | J18 | TC8S 2-L653-*M-RSM 30       | T30 |
|                 |     | SH-GSDM/GKDM/RKM 34-*/S4000 | J18 | TC8S 2-L653-*M-SB 3T        | T30 |
|                 |     | SH-GSDM/GKDM/RKM 44-*       | J18 | TC8S 2-L669-*M              | T26 |
|                 |     | SH-GSDM/GKDM/RKM 44-*/S4000 | J18 | TC8S 2-L669-*M-RS 5.3T      | T28 |
|                 |     | SH-GSDM/GKDM/T30-*          | J18 | TC8S 2-L669-*M-RSM 30       | T30 |
|                 |     | SH-GSDM/GKDM/T30-*/S4000    | J18 | TC8S 2-L669-*M-SB 3T        | T30 |
|                 |     | SH-GSDM/GKDM/T32-*          | J18 | TC8S 2-M587-*M              | T26 |
|                 |     | SH-GSDM/GKDM/T32-*/S4000    | J18 | TC8S 2-M587-*M-PSG 3        | T28 |
|                 |     | SH-GSDM/GKDM/T34-*          | J18 | TC8S 2-M587-*M-PSG 3M       | T28 |
|                 |     | SH-GSDM/GKDM/T34-*/S4000    | J18 | TC8S 2-M642-*M              | T26 |
|                 |     | SH-GSDM/GKDM/T40-*          | J18 | TC8S 2-M642-*M-PSG 3        | T28 |
|                 |     | SH-GSDM/GKDM/T40-*/S4000    | J18 | TC8S 2-M642-*M-PSG 3M       | T28 |
|                 |     | SH-GSDM/GKDM/T42-*          | J18 | TC8S 2-M653-*M              | T26 |
|                 |     | SH-GSDM/GKDM/T42-*/S4000    | J18 | TC8S 2-M653-*M-RS 5.3T      | T28 |
|                 |     | SH-GSDM/GKDM/T44-*          | J18 | TC8S 2-M653-*M-RSM 30       | T30 |
|                 |     | SH-GSDM/GKDM/T44-*/S4000    | J18 | TC8S 2-M653-*M-SB 3T        | T30 |
|                 |     | SH-HSM/2 HKM 4824           | J54 | TC8S 2-M669-*M              | T26 |
|                 |     | SH-RKM/RSM/RKM 57/VM        | M29 | TC8S 2-M669-*M-RS 5.3T      | T28 |
|                 |     | SRF-PG11                    | U5  | TC8S 2-M669-*M-RSM 30       | T30 |
|                 |     | SRF-PG13.5                  | U5  | TC8S 2-M669-*M-SB 3T        | T30 |
|                 |     | ST ID 1/4-INCH-30M          | U9  | TC8S 2-N587-*M              | T26 |

**S**

|                             |     |  |  |  |  |
|-----------------------------|-----|--|--|--|--|
| SB 3T-*                     | E4  |  |  |  |  |
| SB 3T-*/S105                | E4  |  |  |  |  |
| SB 3T-*/S1507               | E4  |  |  |  |  |
| SB 3T-*/S749                | E4  |  |  |  |  |
| SB 3T-*/S90                 | E4  |  |  |  |  |
| SB 3T-3.3/S90-SP            | E7  |  |  |  |  |
| SB 4T-*                     | E5  |  |  |  |  |
| SB 4T-*/S105                | E5  |  |  |  |  |
| SB 4T-*/S727                | E5  |  |  |  |  |
| SB 4T-*/S90                 | E5  |  |  |  |  |
| SB 4T-3.3/S90-SP/S727       | E7  |  |  |  |  |
| SB 5T-*                     | E5  |  |  |  |  |
| SB 6T-*                     | E5  |  |  |  |  |
| SB-CC (10/BAG)              | E18 |  |  |  |  |
| SBE 2T-*                    | E6  |  |  |  |  |
| SBE 3T-*                    | E6  |  |  |  |  |
| SBE 3T-*/S1587              | E6  |  |  |  |  |
| SBE 3T-*/S600               | E6  |  |  |  |  |
| SBE 5T-*                    | E6  |  |  |  |  |
| SBE 5T-*/S1587              | E6  |  |  |  |  |
| SBE 5T-*/S600               | E6  |  |  |  |  |
| SD9S 45x-*M                 | P9  |  |  |  |  |
| SD9S/T 45x-*M               | P8  |  |  |  |  |
| SESM 3S (10/BAG)            | C29 |  |  |  |  |
| SESM 4S (10/BAG)            | C29 |  |  |  |  |
| SH-BKM/BSM/BKM 22           | J34 |  |  |  |  |
| SH-BKM/BSM/BKM 22-380-*     | J34 |  |  |  |  |
| SH-BKM/BSM/BKM 22-380-*/*/* | J34 |  |  |  |  |
| SH-BKM/BSM/BKM 34           | J34 |  |  |  |  |
| SH-BKM/BSM/BKM 34-198-*     | J34 |  |  |  |  |
| SH-BKM/BSM/BKM 34-198-*/*/* | J34 |  |  |  |  |
| SH-BKM/BSM/BKM 44           | J34 |  |  |  |  |
| SH-BKM/BSM/BKM 44-193-*     | J34 |  |  |  |  |
| SH-BKM/BSM/BKM 44-193-*/*/* | J34 |  |  |  |  |
| SH-BKM/BSM/T22-380-*        | J34 |  |  |  |  |
| SH-BKM/BSM/T34-198-*        | J34 |  |  |  |  |
| SH-BKM/BSM/T44-193-*        | J34 |  |  |  |  |
| SH-BSM/2BKM 22              | J34 |  |  |  |  |
| SH-BSM/2BKM 22-380-*        | J34 |  |  |  |  |

# Connectivity Products

## Index

|                        |     |                           |     |                         |     |
|------------------------|-----|---------------------------|-----|-------------------------|-----|
| TC8S 2-N642-*M         | T26 | TC9S 2-L669-*M-RS 5.3T    | T34 | V4RS-*/PKG4M-*/***/S651 | V28 |
| TC8S 2-N653-*M         | T26 | TC9S 2-L669-*M-RSM 30     | T36 | V4RS-*/RK4.4-*/***/S651 | V32 |
| TC8S 2-N653-*M-RS 5.3T | T28 | TC9S 2-L669-*M-SB 3T      | T36 | V6RSC-*/PKG3M-*/***/    | V24 |
| TC8S 2-N653-*M-RSM 30  | T30 | TC9S 2-M587-*M            | T32 | VAS 22-A-FS 5.3         | T38 |
| TC8S 2-N653-*M-SB 3T   | T30 | TC9S 2-M587-*M-PSG 3      | T34 | VAS 22-A587-*M          | T4  |
| TC8S 2-N669-*M         | T26 | TC9S 2-M587-*M-PSG 3M     | T34 | VAS 22-A587-*M-PSG 3    | T6  |
| TC8S 2-N669-*M-RS 5.3T | T28 | TC9S 2-M642-*M            | T32 | VAS 22-A587-*M-PSG 3M   | T6  |
| TC8S 2-N669-*M-RSM 30  | T30 | TC9S 2-M642-*M-PSG 3      | T34 | VAS 22-A642-*M          | T4  |
| TC8S 2-N669-*M-SB 3T   | T30 | TC9S 2-M642-*M-PSG 3M     | T34 | VAS 22-A642-*M-PSG 3    | T6  |
| TC8S 2-P587-*          | T26 | TC9S 2-M653-*M            | T32 | VAS 22-A642-*M-PSG 3M   | T6  |
| TC8S 2-P587-*M-PSG 3   | T28 | TC9S 2-M653-*M-RS 5.3T    | T34 | VAS 22-A653-*M          | T4  |
| TC8S 2-P587-*M-PSG 3M  | T28 | TC9S 2-M653-*M-RSM 30     | T36 | VAS 22-A653-*M-RS 5.3T  | T6  |
| TC8S 2-P642-*          | T26 | TC9S 2-M653-*M-SB 3T      | T36 | VAS 22-A653-*M-RSM 30   | T8  |
| TC8S 2-P642-*M-PSG 3   | T28 | TC9S 2-M669-*M            | T32 | VAS 22-A653-*M-SB 3T    | T8  |
| TC8S 2-P642-*M-PSG 3M  | T28 | TC9S 2-M669-*M-RS 5.3T    | T34 | VAS 22-A669-*M          | T4  |
| TC8S 2-P653-*          | T26 | TC9S 2-M669-*M-RSM 30     | T36 | VAS 22-A669-*M-RS 5.3T  | T6  |
| TC8S 2-P653-*M-RS 5.3T | T28 | TC9S 2-M669-*M-SB 3T      | T36 | VAS 22-A669-*M-RSM 30   | T8  |
| TC8S 2-P653-*M-RSM 30  | T30 | TC9S 2-N587-*M            | T32 | VAS 22-A669-*M-SB 3T    | T8  |
| TC8S 2-P653-*M-SB 3T   | T30 | TC9S 2-N642-*M            | T32 | VAS 22-B587-*M          | T4  |
| TC8S 2-P669-*          | T26 | TC9S 2-N653-*M            | T32 | VAS 22-B587-*M-PSG 3    | T6  |
| TC8S 2-P669-*M-RS 5.3T | T28 | TC9S 2-N653-*M-RS 5.3T    | T34 | VAS 22-B587-*M-PSG 3M   | T6  |
| TC8S 2-P669-*M-RSM 30  | T30 | TC9S 2-N653-*M-RSM 30     | T36 | VAS 22-B642-*M          | T4  |
| TC8S 2-P669-*M-SB 3T   | T30 | TC9S 2-N653-*M-SB 3T      | T36 | VAS 22-B642-*M-PSG 3    | T6  |
| TC9S 2-A587-*M         | T32 | TC9S 2-N669-*M            | T32 | VAS 22-B642-*M-PSG 3M   | T6  |
| TC9S 2-A587-*M-PSG 3   | T34 | TC9S 2-N669-*M-RS 5.3T    | T34 | VAS 22-B653-*M          | T4  |
| TC9S 2-A587-*M-PSG 3M  | T34 | TC9S 2-N669-*M-RSM 30     | T36 | VAS 22-B653-*M-RS 5.3T  | T6  |
| TC9S 2-A642-*M         | T32 | TC9S 2-N669-*M-SB 3T      | T36 | VAS 22-B653-*M-RSM 30   | T8  |
| TC9S 2-A642-*M-PSG 3   | T34 | TC9S 2-P587-*             | T32 | VAS 22-B653-*M-SB 3T    | T8  |
| TC9S 2-A642-*M-PSG 3M  | T34 | TC9S 2-P587-*M-PSG 3      | T34 | VAS 22-B669-*M          | T4  |
| TC9S 2-A653-*M         | T32 | TC9S 2-P587-*M-PSG 3M     | T34 | VAS 22-B669-*M-RS 5.3T  | T6  |
| TC9S 2-A653-*M-RS 5.3T | T34 | TC9S 2-P642-*             | T32 | VAS 22-B669-*M-RSM 30   | T8  |
| TC9S 2-A653-*M-RSM 30  | T36 | TC9S 2-P642-*M-PSG 3      | T34 | VAS 22-B669-*M-SB 3T    | T8  |
| TC9S 2-A653-*M-SB 3T   | T36 | TC9S 2-P642-*M-PSG 3M     | T34 | VAS 22-C587-*M          | T4  |
| TC9S 2-A669-*M         | T32 | TC9S 2-P653-*             | T32 | VAS 22-C642-*M          | T4  |
| TC9S 2-A669-*M-RS 5.3T | T34 | TC9S 2-P653-*M-RS 5.3T    | T34 | VAS 22-C653-*M          | T4  |
| TC9S 2-A669-*M-RSM 30  | T36 | TC9S 2-P653-*M-RSM 30     | T36 | VAS 22-C653-*M-RS 5.3T  | T6  |
| TC9S 2-A669-*M-SB 3T   | T36 | TC9S 2-P653-*M-SB 3T      | T36 | VAS 22-C653-*M-RSM 30   | T8  |
| TC9S 2-AW              | T42 | TC9S 2-P669-*             | T32 | VAS 22-C653-*M-SB 3T    | T8  |
| TC9S 2-L587-*M         | T32 | TC9S 2-P669-*M-RS 5.3T    | T34 | VAS 22-C669-*M          | T4  |
| TC9S 2-L587-*M-PSG 3   | T34 | TC9S 2-P669-*M-RSM 30     | T36 | VAS 22-C669-*M-RS 5.3T  | T6  |
| TC9S 2-L587-*M-PSG 3M  | T34 | TC9S 2-P669-*M-SB 3T      | T36 | VAS 22-C669-*M-RSM 30   | T8  |
| TC9S 2-L642-*M         | T32 |                           |     | VAS 22-C669-*M-SB 3T    | T8  |
| TC9S 2-L642-*M-PSG 3   | T34 | <b>V</b>                  |     | VAS 22-D-FS 5.3         | T38 |
| TC9S 2-L642-*M-PSG 3M  | T34 |                           |     | VAS 22-D587-*M          | T4  |
| TC9S 2-L653-*M         | T32 | V3PSG-*/PKG3Z-*/***/S651  | V44 | VAS 22-D587-*M-PSG 3    | T6  |
| TC9S 2-L653-*M-RS 5.3T | T34 | V3RS-*/RK 4-*/***/S719    | V34 | VAS 22-D587-*M-PSG 3M   | T6  |
| TC9S 2-L653-*M-RSM 30  | T36 | V3RS-*/RK4-*/***/S651     | V26 | VAS 22-D642-*M          | T4  |
| TC9S 2-L653-*M-SB 3T   | T36 | V4FSM/RK4.4-*/***/S651    | V30 | VAS 22-D642-*M-PSG 3    | T6  |
| TC9S 2-L669-*M         | T32 | V4PSGM-*/PKG4M-*/***/S651 | V46 | VAS 22-D642-*M-PSG 3M   | T6  |



**Index**

|                         |     |                    |     |                                  |     |
|-------------------------|-----|--------------------|-----|----------------------------------|-----|
| VAS 22-D653-*M          | T4  | VB 1003-*          | S52 | VB2-FKM/RKC RSC 57x-*M-*M        | M26 |
| VAS 22-D653-*M-RS 5.3T  | T6  | VB 1003-BS14       | S52 | VB2-FKMS 4.5/2FSMS 4.5/S651      | V12 |
| VAS 22-D653-*M-RSM 30   | T8  | VB 1003-PX10-*     | S52 | VB2-FSM 4.4/2FKM 4               | V10 |
| VAS 22-D653-*M-SB 3T    | T8  | VB 1003-PX10-BS14  | S52 | VB2-FSM 4.4/2FKM 4.4/S651        | V12 |
| VAS 22-D669-*M          | T4  | VB 40.5N-*         | S30 | VB2-FSM 4.4/2FKM 4/S719          | V14 |
| VAS 22-D669-*M-RS 5.3T  | T6  | VB 40.5N-CS12      | S30 | VB2-FSM 4.4/2RK 4.4T-*/*/S651    | V12 |
| VAS 22-D669-*M-RSM 30   | T8  | VB 403M-*          | S44 | VB2-FSM 4.4/2RK 4T-*/*           | V10 |
| VAS 22-D669-*M-SB 3T    | T8  | VB 403M-*C         | S44 | VB2-FSM 4.4/2RK 4T-*/*/S719      | V14 |
| VAS 22-E587-*M          | T4  | VB 403M-FS 8       | S44 | VB2-FSM 4.41/2FKM 4.21           | V16 |
| VAS 22-E642-*M          | T4  | VB 403M-PX5-*      | S44 | VB2-FSM 4.41/2RK 4.21T-*/*       | V16 |
| VAS 22-E653-*M          | T4  | VB 403M-PX5-*C     | S44 | VB2-FSM 4.5/2FKM 4.5/S651        | V12 |
| VAS 22-E653-*M-RS 5.3T  | T6  | VB 403M-PX5-FS 8   | S44 | VB2-FSM 4.5/2RK 4.5T-*/*/S651    | V12 |
| VAS 22-E653-*M-RSM 30   | T8  | VB 403Z-*          | S44 | VB2-FSMS 4.5/2FKMS 4.5/S651      | V12 |
| VAS 22-E653-*M-SB 3T    | T8  | VB 403Z-*C         | S44 | VB2-FSW/FKW/FSW 45               | P16 |
| VAS 22-E669-*M          | T4  | VB 403Z-FS 8       | S44 | VB2-RKC 57x-*/*FKM FSM           | M26 |
| VAS 22-E669-*M-RS 5.3T  | T6  | VB 403Z-PX5-*      | S44 | VB2-RS 4.41T-*/*2FKM 4.21        | V16 |
| VAS 22-E669-*M-RSM 30   | T8  | VB 403Z-PX5-*C     | S44 | VB2-RS 4.41T-*/*2RK 4.21T-*/*    | V16 |
| VAS 22-E669-*M-SB 3T    | T8  | VB 403Z-PX5-FS 8   | S44 | VB2-RS 4.4T-*/*2FKM 4            | V10 |
| VAS 22-F587-*M          | T4  | VB 404M-*          | S48 | VB2-RS 4.4T-*/*2FKM 4.4/S651     | V12 |
| VAS 22-F587-*M-PSG 3    | T6  | VB 404M-*C         | S48 | VB2-RS 4.4T-*/*2FKM 4/S719       | V14 |
| VAS 22-F587-*M-PSG 3M   | T6  | VB 404M-BS14       | S48 | VB2-RS 4.4T-*/*2RK 4.4T-*/*/S651 | V12 |
| VAS 22-F642-*M          | T4  | VB 404Z-*          | S48 | VB2-RS 4.4T-*/*2RK 4T-*/*        | V10 |
| VAS 22-F642-*M-PSG 3    | T6  | VB 404Z-*C         | S48 | VB2-RS 4.4T-*/*2RK 4T-*/*/S719   | V14 |
| VAS 22-F642-*M-PSG 3M   | T6  | VB 404Z-BS14       | S48 | VB2-RS 4.5T-*/*2FKM 4.5/S651     | V12 |
| VAS 22-F653-*M          | T4  | VB 40N-*           | S28 | VB2-RS 4.5T-*/*2RK 4.5T-*/*/S651 | V12 |
| VAS 22-F653-*M-RS 5.3T  | T6  | VB 40N-H1151       | S28 | VB2-RS 4.5T-*/*2TC8S 2-A528-*/*  | V22 |
| VAS 22-F669-*M          | T4  | VB 4X1.5N-*        | S30 | VB2-RS 4.5T-*/*2TC8S 2-A653-*/*  | T40 |
| VAS 22-F669-*M-RS 5.3T  | T6  | VB 4X1.5N-CS16     | S30 | VB2-RS 4.5T-*/*2TC9S 2-A528-*/*  | V22 |
| VAS 3-A544-*M           | T10 | VB 4X1N-*          | S28 | VB2-RS 4.5T-*/*2TC9S 2-A653-*/*  | T40 |
| VAS 3-A544-*M-RSC 5.42T | T12 | VB 4X1N-CS12       | S28 | VB2-RS 4.5T-*/*2VAS 22-A528-*/*  | V22 |
| VAS 3-A580-*M           | T10 | VB 803M-*          | S46 | VB2-RS 4.5T-*/*2VAS 22-A653-*/*  | T40 |
| VAS 3-A580-*M-RSC 5.42T | T12 | VB 803M-*C         | S46 | VB2-RS 4.5T-*/*2VBS 2-A528-*/*   | V22 |
| VAS 3-AW                | T42 | VB 803M-BS14       | S46 | VB2-RS 4.5T-*/*2VBS 2-A653-*/*   | T40 |
| VAS 3-B544-*M           | T10 | VB 803M-PX9-*      | S46 | VB2-RS 4.5T-*/*2VIS 2-A528-*/*   | V22 |
| VAS 3-B544-*M-RSC 5.42T | T12 | VB 803M-PX9-*C     | S46 | VB2-RS 4.5T-*/*2VIS 2-A653-*/*   | T40 |
| VAS 3-B580-*M           | T10 | VB 803M-PX9-BS14   | S46 | VB2P3-FSM 4.4/2FKM 4             | V10 |
| VAS 3-B580-*M-RSC 5.42T | T12 | VB 803Z-*          | S46 | VB2P3-FSM 4.4/2RK 4T-*/*         | V10 |
| VAS 3-C544-*M           | T10 | VB 803Z-*C         | S46 | VB2P3-RS 4.4T-*/*2FKM 4          | V10 |
| VAS 3-C544-*M-RSC 5.42T | T12 | VB 803Z-BS14       | S46 | VB2P3-RS 4.4T-*/*2RK 4T-*/*      | V10 |
| VAS 3-C580-*M           | T10 | VB 803Z-PX9-*      | S46 | VBKB 40-*                        | S68 |
| VAS 3-C580-*M-RSC 5.42T | T12 | VB 803Z-PX9-BS14   | S46 | VBKB 40-B1161                    | S68 |
| VAS 3-D544-*M           | T10 | VB 803Z-PX9*C      | S46 | VBKB 40-CS12                     | S68 |
| VAS 3-D544-*M-RSC 5.42T | T12 | VB 804M-*          | S50 | VBKB 40-X5-*                     | S70 |
| VAS 3-D580-*M           | T10 | VB 804M-*C         | S50 | VBKB 40-X5-CS12v                 | S70 |
| VAS 3-D580-*M-RSC 5.42T | T12 | VB 804M-BS19       | S50 | VBKB 60-*                        | S68 |
| VAS 3-E544-*M           | T10 | VB 804Z-*          | S50 | VBKB 60-CS12                     | S68 |
| VAS 3-E544-*M-RSC 5.42T | T12 | VB 804Z-*C         | S50 | VBKB 80-*                        | S68 |
| VAS 3-E580-*M           | T10 | VB 804Z-BS19       | S50 | VBKB 80-CS12                     | S68 |
| VAS 3-E580-*M-RSC 5.42T | T12 | VB2-FKM/FKM/FSM 57 | M26 | VBKB 80-X9-*                     | S70 |

# Connectivity Products

## Index

|                                 |     |                       |     |                       |     |
|---------------------------------|-----|-----------------------|-----|-----------------------|-----|
| VBKB 80-X9-CS12                 | S70 | VBS 2-C587-*M         | T14 | VIS 2-A642-*M-PSG 3M  | T22 |
| VBM 40-*                        | S36 | VBS 2-C642-*M         | T14 | VIS 2-A653-*M         | T20 |
| VBM 40-CS12                     | S36 | VBS 2-C653-*M         | T14 | VIS 2-A653-*M-RS 5.3T | T22 |
| VBM 40-P7X5-*                   | S36 | VBS 2-C653-*M-RS 5.3T | T16 | VIS 2-A653-*M-RSM 30  | T24 |
| VBM 40-P7X5-CS12                | S36 | VBS 2-C653-*M-RSM 30  | T18 | VIS 2-A653-*M-SB 3T   | T24 |
| VBM 40-P7X5-RSF120              | S36 | VBS 2-C653-*M-SB 3T   | T18 | VIS 2-A669-*M         | T20 |
| VBM 40-RSF120                   | S36 | VBS 2-C669-*M         | T14 | VIS 2-A669-*M-RS 5.3T | T22 |
| VBM 80-*                        | S38 | VBS 2-C669-*M-RS 5.3T | T16 | VIS 2-A669-*M-RSM 30  | T24 |
| VBM 80-CS12                     | S38 | VBS 2-C669-*M-RSM 30  | T18 | VIS 2-A669-*M-SB 3T   | T24 |
| VBM 80-P7X9-*                   | S38 | VBS 2-C669-*M-SB 3T   | T18 | VIS 2-AW              | T42 |
| VBM 80-P7X9-CS12                | S38 | VBS 2-D587-*M         | T14 | VIS 2-B587-*M         | T20 |
| VBM 80-P7X9-RSF120              | S38 | VBS 2-D587-*M-PSG 3   | T16 | VIS 2-B587-*M-PSG 3   | T22 |
| VBM 80-RSF120                   | S38 | VBS 2-D587-*M-PSG 3M  | T16 | VIS 2-B587-*M-PSG 3M  | T22 |
| VBM-AC/DC/AC-RSM 70/ADAPTER BOX | S42 | VBS 2-D642-*M         | T14 | VIS 2-B642-*M         | T20 |
| VBRK 4.4-2ESM 3S                | V20 | VBS 2-D642-*M-PSG 3   | T16 | VIS 2-B642-*M-PSG 3   | T22 |
| VBRK 4.4-2PKG 3M-*/*            | V20 | VBS 2-D642-*M-PSG 3M  | T16 | VIS 2-B642-*M-PSG 3M  | T22 |
| VBRK 4.4-2PKG 3Z-*/*            | V20 | VBS 2-D653-*M         | T14 | VIS 2-B653-*M         | T20 |
| VBRK 4.4-2RK 4T-*/*             | V20 | VBS 2-D653-*M-RS 5.3T | T16 | VIS 2-B653-*M-RS 5.3T | T22 |
| VBRK 4.4-2SKM 3                 | V20 | VBS 2-D653-*M-RSM 30  | T18 | VIS 2-B653-*M-RSM 30  | T24 |
| VBRK 4.41-2RK 4.21T-*/*         | V18 | VBS 2-D653-*M-SB 3T   | T18 | VIS 2-B653-*M-SB 3T   | T24 |
| VBS 2-A587-*M                   | T14 | VBS 2-D669-*M         | T14 | VIS 2-B669-*M         | T20 |
| VBS 2-A587-*M-PSG 3             | T16 | VBS 2-D669-*M-RS 5.3T | T16 | VIS 2-B669-*M-RS 5.3T | T22 |
| VBS 2-A587-*M-PSG 3M            | T16 | VBS 2-D669-*M-RSM 30  | T18 | VIS 2-B669-*M-RSM 30  | T24 |
| VBS 2-A642-*M                   | T14 | VBS 2-D669-*M-SB 3T   | T18 | VIS 2-B669-*M-SB 3T   | T24 |
| VBS 2-A642-*M-PSG 3             | T16 | VBS 2-E587-*M         | T14 | VIS 2-C587-*M         | T20 |
| VBS 2-A642-*M-PSG 3M            | T16 | VBS 2-E642-*M         | T14 | VIS 2-C642-*M         | T20 |
| VBS 2-A653-*M                   | T14 | VBS 2-E653-*M         | T14 | VIS 2-C653-*M         | T20 |
| VBS 2-A653-*M-RS 5.3T           | T16 | VBS 2-E653-*M-RS 5.3T | T16 | VIS 2-C653-*M-RS 5.3T | T22 |
| VBS 2-A653-*M-RSM 30            | T18 | VBS 2-E653-*M-RSM 30  | T18 | VIS 2-C653-*M-RSM 30  | T24 |
| VBS 2-A653-*M-SB 3T             | T18 | VBS 2-E653-*M-SB 3T   | T18 | VIS 2-C653-*M-SB 3T   | T24 |
| VBS 2-A669-*M                   | T14 | VBS 2-E669-*M         | T14 | VIS 2-C669-*M         | T20 |
| VBS 2-A669-*M-RS 5.3T           | T16 | VBS 2-E669-*M-RS 5.3T | T16 | VIS 2-C669-*M-RS 5.3T | T22 |
| VBS 2-A669-*M-RSM 30            | T18 | VBS 2-E669-*M-RSM 30  | T18 | VIS 2-C669-*M-RSM 30  | T24 |
| VBS 2-A669-*M-SB 3T             | T18 | VBS 2-E669-*M-SB 3T   | T18 | VIS 2-C669-*M-SB 3T   | T24 |
| VBS 2-AW                        | T42 | VBS 2-F587-*M         | T14 | VIS 2-D587-*M         | T20 |
| VBS 2-B587-*M                   | T14 | VBS 2-F587-*M-PSG 3   | T16 | VIS 2-D587-*M-PSG 3   | T22 |
| VBS 2-B587-*M-PSG 3             | T16 | VBS 2-F587-*M-PSG 3M  | T16 | VIS 2-D587-*M-PSG 3M  | T22 |
| VBS 2-B587-*M-PSG 3M            | T16 | VBS 2-F642-*M         | T14 | VIS 2-D642-*M         | T20 |
| VBS 2-B642-*M                   | T14 | VBS 2-F642-*M-PSG 3   | T16 | VIS 2-D642-*M-PSG 3   | T22 |
| VBS 2-B642-*M-PSG 3             | T16 | VBS 2-F642-*M-PSG 3M  | T16 | VIS 2-D642-*M-PSG 3M  | T22 |
| VBS 2-B642-*M-PSG 3M            | T16 | VBS 2-F653-*M         | T14 | VIS 2-D653-*M         | T20 |
| VBS 2-B653-*M                   | T14 | VBS 2-F653-*M-RS 5.3T | T16 | VIS 2-D653-*M-RS 5.3T | T22 |
| VBS 2-B653-*M-RS 5.3T           | T16 | VBS 2-F669-*M         | T14 | VIS 2-D653-*M-RSM 30  | T24 |
| VBS 2-B653-*M-RSM 30            | T18 | VBS 2-F669-*M-RS 5.3T | T16 | VIS 2-D653-*M-SB 3T   | T24 |
| VBS 2-B653-*M-SB 3T             | T18 | VIS 2-A587-*M         | T20 | VIS 2-D669-*M         | T20 |
| VBS 2-B669-*M                   | T14 | VIS 2-A587-*M-PSG 3   | T22 | VIS 2-D669-*M-RS 5.3T | T22 |
| VBS 2-B669-*M-RS 5.3T           | T16 | VIS 2-A587-*M-PSG 3M  | T22 | VIS 2-D669-*M-RSM 30  | T24 |
| VBS 2-B669-*M-RSM 30            | T18 | VIS 2-A642-*M         | T20 | VIS 2-D669-*M-SB 3T   | T24 |
| VBS 2-B669-*M-SB 3T             | T18 | VIS 2-A642-*M-PSG 3   | T22 | VIS 2-E587-*M         | T20 |

## Index

|                       |     |                |     |                    |     |
|-----------------------|-----|----------------|-----|--------------------|-----|
| VIS 2-E642-*M         | T20 | WD-RKV 30-*M   | F22 | WD-WSV 20-*M       | F22 |
| VIS 2-E653-*M         | T20 | WD-RKV 36-*M   | F22 | WD-WSV 26-*M       | F22 |
| VIS 2-E653-*M-RS 5.3T | T22 | WD-RKV 40-*M   | F22 | WD-WSV 30-*M       | F22 |
| VIS 2-E653-*M-RSM 30  | T24 | WD-RKV 46-*M   | F22 | WD-WSV 36-*M       | F22 |
| VIS 2-E653-*M-SB 3T   | T24 | WD-RKV 50-*M   | F23 | WD-WSV 40-*M       | F22 |
| VIS 2-E669-*M         | T20 | WD-RKV 56-*M   | F23 | WD-WSV 46-*M       | F22 |
| VIS 2-E669-*M-RS 5.3T | T22 | WD-RKV 60-*M   | F23 | WD-WSV 50-*M       | F23 |
| VIS 2-E669-*M-RSM 30  | T24 | WD-RKV 66-*M   | F23 | WD-WSV 56-*M       | F23 |
| VIS 2-E669-*M-SB 3T   | T24 | WD-RSCV 10T-*  | D42 | WD-WSV 60-*M       | F23 |
| VIS 2-F587-*M         | T20 | WD-RSCV 12T-*  | D42 | WD-WSV 66-*M       | F23 |
| VIS 2-F587-*M-PSG 3   | T22 | WD-RSCV 4.4T-* | D41 | WFKD 10-PCBH       | D74 |
| VIS 2-F587-*M-PSG 3M  | T22 | WD-RSCV 4.5T-* | D41 | WFKD 12-PCBH       | D74 |
| VIS 2-F642-*M         | T20 | WD-RSCV 4T-*   | D41 | WFKD 4.5-PCBH      | D73 |
| VIS 2-F642-*M-PSG 3   | T22 | WD-RSCV 6T-*   | D41 | WFKD 6-PCBH        | D73 |
| VIS 2-F642-*M-PSG 3M  | T22 | WD-RSCV 8T-*   | D42 | WFKD 8-PCBH        | D73 |
| VIS 2-F653-*M         | T20 | WD-RSV 20-*M   | F22 | WFKFDH 4.4         | D76 |
| VIS 2-F653-*M-RS 5.3T | T22 | WD-RSV 26-*M   | F22 | WFKFDH 4.5         | D76 |
| VIS 2-F669-*M         | T20 | WD-RSV 30-*M   | F22 | WFS 4.4-PCB        | D72 |
| VIS 2-F669-*M-RS 5.3T | T22 | WD-RSV 36-*M   | F22 | WFS 4.5-PCB        | D72 |
| VZ 1                  | S72 | WD-RSV 40-*M   | F22 | WFS 57-PCB         | M43 |
| VZ 1 (8/labels)       | U5  | WD-RSV 46-*M   | F22 | WFS 6-PCB          | D72 |
| VZ 12                 | S72 | WD-RSV 50-*M   | F23 | WFS 8-PCB          | D72 |
| VZ3 (8/BAG)           | D96 | WD-RSV 56-*M   | F23 | WFS 84-PCB         | K14 |
|                       |     | WD-RSV 60-*M   | F23 | WFS 10-PCBH        | D74 |
|                       |     | WD-RSV 66-*M   | F23 | WFS 12-PCBH        | D74 |
|                       |     | WD-WKCV 10T-*  | D42 | WFS 4.5-PCBH       | D73 |
|                       |     | WD-WKCV 12T-*  | D42 | WFS 6-PCBH         | D73 |
|                       |     | WD-WKCV 4.4T-* | D41 | WFS 8-PCBH         | D73 |
|                       |     | WD-WKCV 4.5T-* | D41 | WFS 4.4            | D76 |
|                       |     | WD-WKCV 4T-*   | D41 | WFS 4.5            | D76 |
|                       |     | WD-WKCV 6T-*   | D41 | WFS 45-PCB         | P13 |
|                       |     | WD-WKCV 8T-*   | D42 | WK 4.21T-*         | D7  |
|                       |     | WD-WKV 20-*M   | F22 | WK 4.21T-*/S1511   | D7  |
|                       |     | WD-WKV 26-*M   | F22 | WK 4.21T-*/S90     | D7  |
|                       |     | WD-WKV 30-*M   | F22 | WK 4.22T-*         | D7  |
|                       |     | WD-WKV 36-*M   | F22 | WK 4.23T-*         | D7  |
|                       |     | WD-WKV 40-*M   | F22 | WK 4.2T-*          | D7  |
|                       |     | WD-WKV 46-*M   | F22 | WK 4.2T-*/S748     | D7  |
|                       |     | WD-WKV 50-*M   | F23 | WK 4.2T-*/S90      | D7  |
|                       |     | WD-WKV 56-*M   | F23 | WK 4.41T-*         | D9  |
|                       |     | WD-WKV 60-*M   | F23 | WK 4.41T-*/S529    | D9  |
|                       |     | WD-WKV 66-*M   | F23 | WK 4.43T-*         | D9  |
|                       |     | WD-WSCV 10T-*  | D42 | WK 4.43T-*/S90     | D9  |
|                       |     | WD-WSCV 12T-*  | D42 | WK 4.4T-*          | D9  |
|                       |     | WD-WSCV 4.4T-* | D41 | WK 4.4T-*N7X2      | D29 |
|                       |     | WD-WSCV 4.5T-* | D41 | WK 4.4T-*N7X2/S101 | D29 |
|                       |     | WD-WSCV 4T-*   | D41 | WK 4.4T-*N7X2/S618 | D30 |
|                       |     | WD-WSCV 6T-*   | D41 | WK 4.4T-*N7X2/S90  | D29 |
|                       |     | WD-WSCV 8T-*   | D42 | WK 4.4T-*P7X2      | D29 |
|                       |     | WD-RKV 20-*M   | F22 |                    |     |
|                       |     | WD-RKV 26-*M   | F22 |                    |     |

## W

|                  |     |                |     |                    |     |
|------------------|-----|----------------|-----|--------------------|-----|
| WAKW 4.5T-*      | D34 | WD-WKCV 12T-*  | D42 | WFS 10-PCBH        | D74 |
| WAKW 4.5T-*/S101 | D34 | WD-WKCV 4.4T-* | D41 | WFS 12-PCBH        | D74 |
| WAKW 4.5T-*/S618 | D34 | WD-WKCV 4.5T-* | D41 | WFS 4.5-PCBH       | D73 |
| WAKW 4.5T-*/S653 | D34 | WD-WKCV 4T-*   | D41 | WFS 6-PCBH         | D73 |
| WAKW 4T-*/S626   | D34 | WD-WKCV 6T-*   | D41 | WFS 8-PCBH         | D73 |
| WASW 4.5T-*      | D34 | WD-WKCV 8T-*   | D42 | WFS 4.4            | D76 |
| WASW 4.5T-*/S101 | D34 | WD-WKV 20-*M   | F22 | WFS 4.5            | D76 |
| WASW 4.5T-*/S618 | D34 | WD-WKV 26-*M   | F22 | WFS 45-PCB         | P13 |
| WASW 4.5T-*/S653 | D34 | WD-WKV 30-*M   | F22 | WK 4.21T-*         | D7  |
| WASW 4T-*/S626   | D34 | WD-WKV 36-*M   | F22 | WK 4.21T-*/S90     | D7  |
| WBK 14-0         | G29 | WD-WKV 40-*M   | F22 | WK 4.22T-*         | D7  |
| WBK 19-0         | G29 | WD-WKV 46-*M   | F22 | WK 4.23T-*         | D7  |
| WBS 14-0         | G29 | WD-WKV 50-*M   | F22 | WK 4.2T-*          | D7  |
| WBS 19-0         | G29 | WD-WKV 56-*M   | F23 | WK 4.2T-*/S748     | D7  |
| WD-RKCV 10T-*    | D42 | WD-WKV 60-*M   | F23 | WK 4.2T-*/S90      | D7  |
| WD-RKCV 12T-*    | D42 | WD-WKV 66-*M   | F23 | WK 4.41T-*         | D9  |
| WD-RKCV 4.4T-*   | D41 | WD-WSCV 10T-*  | F23 | WK 4.41T-*/S529    | D9  |
| WD-RKCV 4.5T-*   | D41 | WD-WSCV 12T-*  | F23 | WK 4.43T-*         | D9  |
| WD-RKCV 4T-*     | D41 | WD-WSCV 4.4T-* | D42 | WK 4.43T-*/S90     | D9  |
| WD-RKCV 6T-*     | D41 | WD-WSCV 4.5T-* | D42 | WK 4.4T-*          | D9  |
| WD-RKCV 8T-*     | D42 | WD-WSCV 4T-*   | D41 | WK 4.4T-*N7X2      | D29 |
| WD-RKV 20-*M     | F22 | WD-WSCV 6T-*   | D41 | WK 4.4T-*N7X2/S101 | D29 |
| WD-RKV 26-*M     | F22 | WD-WSCV 8T-*   | D41 | WK 4.4T-*N7X2/S618 | D30 |
|                  |     |                | D42 | WK 4.4T-*N7X2/S90  | D29 |
|                  |     |                | D42 | WK 4.4T-*P7X2      | D29 |

# Connectivity Products

## Index

|                       |     |                        |          |                             |     |
|-----------------------|-----|------------------------|----------|-----------------------------|-----|
| WK 4.4T-*/P7X2/S101   | D29 | WKB 3T-*/S90           | E4       | WKC 6T-*/S90/S760           | D17 |
| WK 4.4T-*/P7X2/S618   | D30 | WKB 3T-3.3/S90-SP      | E7       | WKC 6T-*/S90/CS10476        | D17 |
| WK 4.4T-*/P7X2/S824   | D30 | WKB 4T-*               | E5       | WKC 6T-3.3/S90-SP           | D37 |
| WK 4.4T-*/P7X2/S90    | D29 | WKB 4T-*/S105          | E5       | WKC 8.6T-*                  | D18 |
| WK 4.4T-*/P7X3        | D31 | WKB 4T-*/S727          | E5       | WKC 8.6T-3.3/S90-SP/CS10451 | D37 |
| WK 4.4T-*/P7X3/S101   | D31 | WKB 4T-*/S90           | E5       | WKC 8.8T-*                  | D18 |
| WK 4.4T-*/P7X3/S90    | D31 | WKB 4T-3.3/S90-SP/S727 | E7       | WKC 84x-*/M                 | K6  |
| WK 4.4T-*/S101        | D9  | WKB 5T-*               | E5       | WKC 8T-*                    | D18 |
| WK 4.4T-*/S1587       | D10 | WKB 6T-*               | E5       | WKC 8T-*/S101               | D18 |
| WK 4.4T-*/S1666       | D10 | WKBE 2T-*              | E6       | WKC 8T-*/S1555              | D18 |
| WK 4.4T-*/S618        | D9  | WKBE 3T-*              | E6       | WKC 8T-*/S618               | D18 |
| WK 4.4T-*/S618/S824   | D9  | WKBE 3T-*/S1587        | E6       | WKC 8T-*/S715               | D18 |
| WK 4.4T-*/S653        | D10 | WKBE 3T-*/S600         | E6       | WKC 8T-*/S90                | D18 |
| WK 4.4T-*/S760        | D10 | WKBE 5T-*              | E6       | WKC BK52C 57x-*/M           | M15 |
| WK 4.4T-*/S824        | D9  | WKBE 5T-*/S1587        | E6       | WKC CBC5 57x-*/M            | M15 |
| WK 4.4T-*/S90         | D9  | WKBE 5T-*/S600         | E6       | WKC FKFD 25x-*/M            | R9  |
| WK 4.4T-*/S90/S670    | D10 | WKC 10T-*              | D19      | WKC FKFD 57x-*/M            | M13 |
| WK 4.4T-3.3/S90-SP    | D35 | WKC 10T-*/S101         | D19      | WKC FKFD 84x-*/M            | K7  |
| WK 4.4T-3/S90-SP/S669 | D35 | WKC 10T-*/S618         | D19      | WKC FSFD 25x-*/M            | R9  |
| WK 4.5T-*             | D11 | WKC 10T-*/S90          | D19      | WKC FSFD 57x-*/M            | M13 |
| WK 4.5T-*/P7X2        | D30 | WKC 12T-*              | D20      | WKC FSFD 84x-*/M            | K6  |
| WK 4.5T-*/S101        | D11 | WKC 12T-*/S618         | D20      | WKC RJ45 84x-*/M            | K7  |
| WK 4.5T-*/S1554       | D11 | WKC 12T-*/S90          | D20      | WKC RJ45IP67 84x-*/M        | K7  |
| WK 4.5T-*/S618        | D11 | WKC 25x-*/M            | R9       | WKC RJ45MIP67 84x-*/M       | K7  |
| WK 4.5T-*/S653        | D11 | WKC 4.2T-*             | D14      | WKC RKFP 25x-*/M            | R9  |
| WK 4.5T-*/S90         | D11 | WKC 4.2T-*/CS10191     | D14      | WKC RKFP 57x-*/M            | M13 |
| WK 4.5T-3.3/S90-SP    | D35 | WKC 4.4Q-*/S849        | D44      | WKC RSFP 25x-*/M            | R9  |
| WK 4.6T-*             | D12 | WKC 4.4T-*             | D15      | WKC RSFP 57x-*/M            | M13 |
| WK 4.6T-*/S618        | D12 | WKC 4.4T-*/S101        | D15      | WKC WKC 25x-*/M             | R9  |
| WK 4.6T-*/S653        | D12 | WKC 4.4T-*/S101/S849   | D15      | WKC WKC 57x-*/M             | M12 |
| WK 4.6T-*/S90         | D12 | WKC 4.4T-*/S1587       | D15      | WKC WKC 84x-*/M             | K6  |
| WK 4.6T-*/S90/S760    | D12 | WKC 4.4T-*/S622        | D15      | WKC WRJ45E 84x-*/M          | K7  |
| WK 4T-*/N7X2          | D28 | WKC 4.4T-*/S824        | D15      | WKCD 44x-*/M                | K16 |
| WK 4T-*/N7X2/S101     | D28 | WKC 4.4T-*/S90         | D15      | WKCD FKFD 44x-*/M           | K17 |
| WK 4T-*/N7X2/S618     | D28 | WKC 4.5Q-*/S849        | D44      | WKCD FSFD 44x-*/M           | K16 |
| WK 4T-*/N7X2/S715     | D28 | WKC 4.5T-*/CS10288     | D16      | WKCD RJ45 44x-*/M           | K17 |
| WK 4T-*/N7X2/S824     | D28 | WKC 4.5T-*/S1538       | D16      | WKCD RJ45IP67 44x-*/M       | K17 |
| WK 4T-*/N7X2/S90      | D28 | WKC 4.5T-*/S1587       | D16      | WKCD RJ45MIP67 44x-*/M      | K17 |
| WK 4T-*/P7X2          | D28 | WKC 4.5T-*/S653        | D16      | WKCD RKCD 44x-*/M           | K16 |
| WK 4T-*/P7X2/S101     | D28 | WKC 4.5T-*/S715/S849   | D16      | WKCD WKCD 44x-*/M           | K16 |
| WK 4T-*/P7X2/S618     | D28 | WKC 4T-*               | D14      | WKCD WRJ45E 44x-*/M         | K17 |
| WK 4T-*/P7X2/S715     | D28 | WKC 57x-*/M            | M11, M12 | WKC 5T-*                    | D16 |
| WK 4T-*/P7X2/S824     | D28 | WKC 6T-*               | D17      | WKC 48x-*/M                 | P23 |
| WK 4T-*/P7X2/S90      | D28 | WKC 6T-*/S101          | D17      | WKC 49x-*/M                 | N9  |
| WK 4T-3.3/S90-SP      | D35 | WKC 6T-*/S529          | D17      | WKC FKFDV 48x-*/M           | P23 |
| WKB 3T-*              | E4  | WKC 6T-*/S618          | D17      | WKC FSFDV 48x-*/M           | P23 |
| WKB 3T-*/S105         | E4  | WKC 6T-*/S653          | D17      | WKC FSFDV 49x-*/M           | N9  |
| WKB 3T-*/S1507        | E4  | WKC 6T-*/S849/S1052    | D17      | WKC RKFPV 48x-*/M           | P23 |
| WKB 3T-*/S749         | E4  | WKC 6T-*/S90           | D17      | WKC RKFPV 49x-*/M           | N9  |

## Index

|                      |     |                  |     |                            |          |
|----------------------|-----|------------------|-----|----------------------------|----------|
| WKCV RSFPV 48x-*M    | P23 | WKM 50-1M/S90-SP | F21 | WKS 4.4T-*                 | D26      |
| WKCV RSFPV 49x-*M    | N9  | WKM 511-*M       | F9  | WKS 4.4T-*/S824            | D26      |
| WKCV WKCV 48x-*M     | P23 | WKM 511-*M/S600  | F9  | WKS 4.4T-*/S90             | D26      |
| WKCV WKCV 49x-*M     | N9  | WKM 55-*M        | F13 | WKS 4.5T-*                 | D26      |
| WKE 4.4T-2-P7X3/S600 | D32 | WKM 55-*M/S600   | F13 | WKS 6T-*                   | D26      |
| WKE 4T-*N7X2/S600    | D32 | WKM 56-*M        | F13 | WKS 84x-*M                 | K8       |
| WKE 4T-*P7X2/S600    | D32 | WKM 56-*M/S1587  | F13 | WKS 8T-*                   | D27      |
| WKM 106-*M           | F16 | WKM 61-*M        | F10 | WKS FKSDE 84x-*M           | K9       |
| WKM 106-*M/S101      | F16 | WKM 61-*M/S739   | F10 | WKS FSSDE 84x-*M           | K9       |
| WKM 106-*M/S1587     | F16 | WKM 61-*M/S763   | F10 | WKS RJ45S 84x-*M           | K9       |
| WKM 106-*M/S90       | F16 | WKM 66-*M        | F13 | WKS RJ45SMIP67 84x-*M      | K9       |
| WKM 126-*M           | F17 | WKM 66-*M/S1587  | F13 | WKS RKS 84x-*M             | K8       |
| WKM 126-*M/S101      | F17 | WKM 6B6-*M       | F14 | WKS WKS 84x-*M             | K8       |
| WKM 126-*M/S1587     | F17 | WKM 6B6-*M/S101  | F14 | WKS WRJ45ES 84x-*M         | K9       |
| WKM 126-*M/S90       | F17 | WKM 6B6-*M/S90   | F14 | WKS D 44x-*M               | K18      |
| WKM 190-*M           | F18 | WKM 76-*M        | F14 | WKS D FSSDED 44x-*M        | K19      |
| WKM 190-*M/S101      | F18 | WKM 76-*M/S101   | F14 | WKS D RJ45S 44x-*M         | K19      |
| WKM 190-*M/S760      | F18 | WKM 76-*M/S1587  | F14 | WKS D RJ45SMIP67 44x-*M    | K19      |
| WKM 190-*M/S90       | F18 | WKM 76-*M/S90    | F14 | WKS D WKS D 44x-*M         | K18      |
| WKM 20-*M            | F6  | WKM 86-*M        | F15 | WKS D WRJ45ES 44x-*M       | K19      |
| WKM 25x-*M           | R8  | WKM 86-*M/S101   | F15 | WKS D WSSD 44x-*M          | K18      |
| WKM 26-*M            | F11 | WKM 86-*M/S1587  | F15 | WKS W 45x-*M               | P6       |
| WKM 30-*M            | F6  | WKM 86-*M/S90    | F15 | WKS W D9S WKS W 45x-*M-*M  | P9       |
| WKM 30-*M/S101       | F6  | WKM 96-*M        | F16 | WKS W D9S/T 45x-*M         | P8       |
| WKM 30-*M/S90        | F6  | WKM 96-*M/S101   | F16 | WKS W D9SM WKS W 45x-*M-*M | P9       |
| WKM 30-2M/S90-SP     | F21 | WKM 96-*M/S1587  | F16 | WKS W D9SM/T 45x-*M        | P8       |
| WKM 31-*M            | F7  | WKM 96-*M/S90    | F16 | WKS W SD9S WKS W 45x-*M-*M | P9       |
| WKM 31-*M/S600       | F7  | WKM BK52C 57x-*M | M14 | WKS W SD9S/T 45x-*M        | P8       |
| WKM 311-*M           | F6  | WKM CBC5 57x-*M  | M14 | WKS W WKS W 45x-*M         | P6       |
| WKM 311-*M/S600      | F6  | WKM FKFD 25x-*M  | R9  | WKT 57x-*                  | M19, M20 |
| WKM 34-*M/S4000      | J4  | WKM FKFD 57x-*M  | M11 | WKV 48x-*M                 | P22      |
| WKM 35-*M            | F11 | WKM FSFD 25x-*M  | R9  | WKV 49x-*M                 | N8       |
| WKM 35-*M/S600       | F11 | WKM FSFD 57x-*M  | M11 | WKV FKFDV 48x-*M           | P23      |
| WKM 36-*M            | F11 | WKM RKC 25x-*M   | R9  | WKV FKFDV 49x-*M           | N9       |
| WKM 36-*M/S1587      | F11 | WKM RKC 57x-*M   | M11 | WKV FSFDV 48x-*M           | P23      |
| WKM 40-*M            | F8  | WKM RKFP 25x-*M  | R9  | WKV FSFDV 49-*M            | N9       |
| WKM 40-*M/S101       | F8  | WKM RKFP 57x-*M  | M11 | WKV RKCV 48x-*M            | P23      |
| WKM 40-*M/S529       | F8  | WKM RSC 25x-*M   | R8  | WKV RKCV 49x-*M            | N9       |
| WKM 40-*M/S600       | F8  | WKM RSC 57x-*M   | M10 | WKV RKFPV 48x-*M           | P23      |
| WKM 40-*M/S90        | F8  | WKM RSFP 25x-*M  | R9  | WKV RKFPV 49x-*M           | N9       |
| WKM 44-*M/S4000      | J4  | WKM RSFP 57x-*M  | M11 | WKV RSCV 48x-*M            | P22      |
| WKM 46-*M            | F12 | WKM WKC 25x-*M   | R9  | WKV RSCV 49x-*M            | N8       |
| WKM 46-*M/S600       | F12 | WKM WKC 57x-*M   | M11 | WKV RSFPV 48x-*M           | P23      |
| WKM 46-*M/S824       | F12 | WKM WKM 25x-*M   | R8  | WKV RSFPV 49x-*M           | N9       |
| WKM 47-*M            | F12 | WKM WKM 57x-*M   | M10 | WKV WKCV 48x-*M            | P23      |
| WKM 50-*M            | F9  | WKM WSC 25x-*M   | R9  | WKV WKCV 49x-*M            | N9       |
| WKM 50-*M/S101       | F9  | WKM WSC 57x-*M   | M11 | WKV WKV 48x-*M             | P22      |
| WKM 50-*M/S1551      | F9  | WKS 10T-*        | D27 | WKV WKV 49x-*M             | N8       |
| WKM 50-*M/S90        | F9  | WKS 12T-*        | D27 | WKV WSCV 48x-*M            | P23      |

# Connectivity Products

## Index

|                           |     |                       |     |                        |     |
|---------------------------|-----|-----------------------|-----|------------------------|-----|
| WKV WSCV 49x-*M           | N9  | WS 4.2T-*             | D7  | WSB 4T-*/S105          | E5  |
| WMFK 3F-PCB               | C19 | WS 4.2T-*/S748        | D7  | WSB 4T-*/S727          | E5  |
| WMFK 4F-PCB               | C19 | WS 4.2T-*/S90         | D7  | WSB 4T-*/S90           | E5  |
| WMFK 6F-PCB               | C19 | WS 4.41T-*            | D9  | WSB 4T-3.3/S90-SP/S727 | E7  |
| WMFKSH 3F-PCB             | C21 | WS 4.41T-*/S529       | D9  | WSB 5T-*               | E5  |
| WMFKSH 4F-PCB             | C21 | WS 4.43T-*            | D9  | WSB 6T-*               | E5  |
| WMFS 3-PCB                | C20 | WS 4.43T-*/S90        | D9  | WSBE 2T-*              | E6  |
| WMFS 3F-PCB               | C20 | WS 4.4T-*             | D9  | WSBE 3T-*              | E6  |
| WMFS 4-PCB                | C20 | WS 4.4T-*/S101        | D9  | WSBE 3T-*/S1587        | E6  |
| WMFS 4F-PCB               | C20 | WS 4.4T-*/S1587       | D10 | WSBE 3T-*/S600         | E6  |
| WMFS 6-PCB                | C20 | WS 4.4T-*/S1666       | D10 | WSBE 5T-*              | E6  |
| WMFS 6F-PCB               | C20 | WS 4.4T-*/S618        | D9  | WSBE 5T-*/S1587        | E6  |
| WRJ45 FKSDE 84x-*M        | K9  | WS 4.4T-*/S618/S824   | D9  | WSBE 5T-*/S600         | E6  |
| WRJ45 FSSDE 84x-*M        | K9  | WS 4.4T-*/S653        | D10 | WSC 10T-*              | D19 |
| WRJ45 RJ45MIP67 84x-*M    | K7  | WS 4.4T-*/S760        | D10 | WSC 10T-*/S101         | D19 |
| WRJ45E 44x-*M             | K17 | WS 4.4T-*/S824        | D9  | WSC 10T-*/S618         | D19 |
| WRJ45E 84x-*M             | K7  | WS 4.4T-*/S90         | D9  | WSC 10T-*/S90          | D19 |
| WRJ45E FKFD 84x-*M        | K7  | WS 4.4T-*/S90/S670    | D10 | WSC 12T-*              | D20 |
| WRJ45E FKFD 44x-*M        | K17 | WS 4.4T-3.3/S90-SP    | D36 | WSC 12T-*/S101         | D20 |
| WRJ45E FSFD 84x-*M        | K6  | WS 4.4T-3/S90-SP/S669 | D36 | WSC 12T-*/S618         | D20 |
| WRJ45E FSFD 44x-*M        | K16 | WS 4.5T-*             | D11 | WSC 12T-*/S90          | D20 |
| WRJ45E RJ45 44x-*M        | K17 | WS 4.5T-*/S101        | D11 | WSC 25x-*M             | R9  |
| WRJ45E RJ45 84x-*M        | K7  | WS 4.5T-*/S1554       | D11 | WSC 4.2T-*             | D14 |
| WRJ45E RJ45IP67 44x-*M    | K17 | WS 4.5T-*/S618        | D11 | WSC 4.2T-*/CS10191     | D14 |
| WRJ45E RJ45IP67 84x-*M    | K7  | WS 4.5T-*/S653        | D11 | WSC 4.4Q-*/S849        | D44 |
| WRJ45E RJ45MIP67 44x-*M   | K17 | WS 4.5T-*/S715        | D11 | WSC 4.4T-*             | D15 |
| WRJ45E WRJ45E 44x-*M      | K17 | WS 4.5T-*/S90         | D11 | WSC 4.4T-*/S101        | D15 |
| WRJ45E WRJ45E 84x-*M      | K7  | WS 4.5T-3.3/S90-SP    | D36 | WSC 4.4T-*/S101/S849   | D15 |
| WRJ45ES 42x-*M            | L5  | WS 4.6T-*             | D12 | WSC 4.4T-*/S1587       | D15 |
| WRJ45ES 44x-*M            | K19 | WS 4.6T-*/S618        | D12 | WSC 4.4T-*/S622        | D15 |
| WRJ45ES 84x-*M            | K9  | WS 4.6T-*/S653        | D12 | WSC 4.4T-*/S824        | D15 |
| WRJ45ES FKSD 42x-*M       | L4  | WS 4.6T-*/S90         | D12 | WSC 4.4T-*/S90         | D15 |
| WRJ45ES FKSD 44x-*M       | K19 | WS 4.6T-*/S90/S760    | D12 | WSC 4.5Q-*/S849        | D44 |
| WRJ45ES FSSD 42x-*M       | L4  | WS 4T-*               | D8  | WSC 4.5T-*/CS10288     | D16 |
| WRJ45ES FSSD 44x-*M       | K19 | WS 4T-*/S101          | D8  | WSC 4.5T-*/S1538       | D16 |
| WRJ45ES RJ45S 42x-*M      | L5  | WS 4T-*/S529          | D8  | WSC 4.5T-*/S1587       | D16 |
| WRJ45ES RJ45S 44x-*M      | K19 | WS 4T-*/S618          | D8  | WSC 4.5T-*/S653        | D16 |
| WRJ45ES RJ45S 84x-*M      | K9  | WS 4T-*/S715          | D8  | WSC 4.5T-*/S715/S849   | D16 |
| WRJ45ES RJ45SMIP67 42x-*M | L5  | WS 4T-*/S760          | D8  | WSC 4T-*               | D14 |
| WRJ45ES RJ45SMIP67 44x-*M | K19 | WS 4T-*/S824          | D8  | WSC 57x-*M             | M11 |
| WRJ45ES RJ45SMIP67 84x-*M | K9  | WS 4T-*/S90           | D8  | WSC 57x*-M             | M12 |
| WRJ45ES WRJ45ES 42x-*M    | L5  | WS 4T-3.3/S90-SP      | D36 | WSC 6T-*               | D17 |
| WRJ45ES WRJ45ES 44x-*M    | K19 | WSB 3T-*              | E4  | WSC 6T-*/S101          | D17 |
| WRJ45ES WRJ45ES 84x-*M    | K9  | WSB 3T-*/S105         | E4  | WSC 6T-*/S529          | D17 |
| WS 4.21T-*                | D7  | WSB 3T-*/S1507        | E4  | WSC 6T-*/S618          | D17 |
| WS 4.21T-*/S1511          | D7  | WSB 3T-*/S749         | E4  | WSC 6T-*/S653          | D17 |
| WS 4.21T-*/S90            | D7  | WSB 3T-*/S90          | E4  | WSC 6T-*/S849/S1052    | D17 |
| WS 4.22T-*                | D7  | WSB 3T-3.3/S90-SP     | E7  | WSC 6T-*/S90           | D17 |
| WS 4.23T-*                | D7  | WSB 4T-*              | E5  | WSC 6T-*/S90/CS10476   | D17 |

## Index

|                             |     |                   |     |                  |     |
|-----------------------------|-----|-------------------|-----|------------------|-----|
| WSC 6T-*/S90/S760           | D17 | WSCV 48x-*M       | P23 | WSM 44-*M/S4000  | J4  |
| WSC 6T-3.3/S90-SP           | D38 | WSCV 49x-*M       | N9  | WSM 46-*M        | F12 |
| WSC 8.6T-*                  | D18 | WSCV FKFDV 48x-*M | P23 | WSM 46-*M/S600   | F12 |
| WSC 8.6T-3.3/S90-SP/CS10451 | D38 | WSCV FKFDV 49x-*M | N9  | WSM 46-*M/S824   | F12 |
| WSC 8.8T-*                  | D18 | WSCV FSFDV 48x-*M | P23 | WSM 47-*M        | F12 |
| WSC 84x-*M                  | K6  | WSCV FSFDV 49x-*M | N9  | WSM 50-*M        | F9  |
| WSC 8T-*/S101               | D18 | WSCV RKCV 48x-*M  | P23 | WSM 50-*M/S101   | F9  |
| WSC 8T-*/S1555              | D18 | WSCV RKCV 49x-*M  | N9  | WSM 50-*M/S1551  | F9  |
| WSC 8T-*/S618               | D18 | WSCV RKFPV 48x-*M | P23 | WSM 50-*M/S90    | F9  |
| WSC 8T-*/S715               | D18 | WSCV RKFPV 49x-*M | N9  | WSM 50-1M/S90-SP | F21 |
| WSC 8T-*/S90                | D18 | WSCV RSFPV 48x-*M | P23 | WSM 511-*M       | F9  |
| WSC BK52C 57x-*M            | M15 | WSCV RSFPV 49x-*M | N9  | WSM 511-*M/S600  | F9  |
| WSC CBC5 57x-*M             | M15 | WSCV WKCV 48x-*M  | P23 | WSM 55-*M        | F13 |
| WSC FKFD 25x-*M             | R9  | WSCV WKCV 49x-*M  | N9  | WSM 55-*M/S600   | F13 |
| WSC FKFD 57x-*M             | M13 | WSCV WSCV 48x-*M  | P23 | WSM 56-*M        | F13 |
| WSC FKFD 84x-*M             | K7  | WSCV WSCV 49x-*M  | N9  | WSM 56-*M/S1587  | F13 |
| WSC FSFD 25x-*M             | R9  | WSM 106-*M        | F16 | WSM 57x-*M       | M10 |
| WSC FSFD 57x-*M             | M13 | WSM 106-*M/S101   | F16 | WSM 61-*M        | F10 |
| WSC FSFD 84x-*M             | K6  | WSM 106-*M/S1587  | F16 | WSM 61-*M/S739   | F10 |
| WSC RJ45 84x-*M             | K7  | WSM 106-*M/S90    | F16 | WSM 61-*M/S763   | F10 |
| WSC RJ45IP67 84x-*M         | K7  | WSM 126-*M        | F17 | WSM 66-*M        | F13 |
| WSC RJ45MIP67 84x-*M        | K7  | WSM 126-*M/S101   | F17 | WSM 66-*M/S1587  | F13 |
| WSC RKC 25x-*M              | R9  | WSM 126-*M/S1587  | F17 | WSM 6B6-*M       | F14 |
| WSC RKC 57x-*M              | M12 | WSM 126-*M/S90    | F17 | WSM 6B6-*M/S101  | F14 |
| WSC RKC 84x-*M              | K6  | WSM 190-*M        | F18 | WSM 6B6-*M/S90   | F14 |
| WSC RKFP 25x-*M             | R9  | WSM 190-*M/S101   | F18 | WSM 76-*M        | F14 |
| WSC RKFP 57x-*M             | M13 | WSM 190-*M/S760   | F18 | WSM 76-*M/S101   | F14 |
| WSC RSC 84x-*M              | K6  | WSM 190-*M/S90    | F18 | WSM 76-*M/S1587  | F14 |
| WSC RSFP 25x-*M             | R9  | WSM 20-*M         | F6  | WSM 76-*M/S90    | F14 |
| WSC RSFP 57x-*M             | M13 | WSM 25x-*M        | R8  | WSM 86-*M        | F15 |
| WSC WKC 25x-*M              | R9  | WSM 26-*M         | F11 | WSM 86-*M/S101   | F15 |
| WSC WKC 57x-*M              | M12 | WSM 30-*M         | F6  | WSM 86-*M/S1587  | F15 |
| WSC WKC 84x-*M              | K6  | WSM 30-*M/S101    | F6  | WSM 86-*M/S90    | F15 |
| WSC WRJ45E 84x-*M           | K7  | WSM 30-*M/S90     | F6  | WSM 96-*M        | F16 |
| WSC WSC 25x-*M              | R9  | WSM 30-2M/S90-SP  | F21 | WSM 96-*M/S101   | F16 |
| WSC WSC 57x-*M              | M12 | WSM 31-*M         | F7  | WSM 96-*M/S1587  | F16 |
| WSC WSC 84x-*M              | K6  | WSM 31-*M/S600    | F7  | WSM 96-*M/S90    | F16 |
| WSCD 44x-*M                 | K16 | WSM 311-*M        | F6  | WSM BK52C 57x-*M | M14 |
| WSCD FKFD 44x-*M            | K17 | WSM 311-*M/S600   | F6  | WSM CBC5 57x-*M  | M14 |
| WSCD FSFD 44x-*M            | K16 | WSM 34-*M/S4000   | J4  | WSM FKFD 25x-*M  | R9  |
| WSCD RJ45 44x-*M            | K17 | WSM 35-*M         | F11 | WSM FKFD 57x-*M  | M11 |
| WSCD RJ45IP67 44x-*M        | K17 | WSM 35-*M/S600    | F11 | WSM FSFD 25x-*M  | R9  |
| WSCD RJ45MIP67 44x-*M       | K17 | WSM 36-*M         | F11 | WSM FSFD 57x-*M  | M11 |
| WSCD RKCD 44x-*M            | K16 | WSM 36-*M/S1587   | F11 | WSM RKC 25x-*M   | R9  |
| WSCD RSCD 44x-*M            | K16 | WSM 40-*M         | F8  | WSM RKC 57x-*M   | M11 |
| WSCD WKCD 44x-*M            | K16 | WSM 40-*M/S101    | F8  | WSM RKFP 25x-*M  | R9  |
| WSCD WRJ45E 44x-*M          | K17 | WSM 40-*M/S529    | F8  | WSM RKFP 57x-*M  | M11 |
| WSCD WSCD 44x-*M            | K16 | WSM 40-*M/S600    | F8  | WSM RKM 25x-*M   | R8  |
| WSCN 5T-*                   | D16 | WSM 40-*M/S90     | F8  | WSM RKM 57       | M35 |

# Connectivity Products

## Index

|                          |     |                          |     |                                |     |
|--------------------------|-----|--------------------------|-----|--------------------------------|-----|
| WSM RKM 57x-*M           | M10 | WSSW D9SM WSSW 45x-*M-*M | P9  | WWASW 4T-*/S626                | D34 |
| WSM RSC 25x-*M           | R8  | WSSW D9SM/T 45x-*M       | P8  |                                |     |
| WSM RSC 57x-*M           | M10 | WSSW RKSX 45x-*M         | P6  | <b>X</b>                       |     |
| WSM RSFP 25x-*M          | R9  | WSSW SD9S WKSX 45x-*M-*M | P9  |                                |     |
| WSM RSFP 57x-*M          | M11 | WSSW SD9S WSSW 45x-*M-*M | P9  | XSH-RKM/RSM/RKM 57             | M31 |
| WSM WKC 25x-*M           | R9  | WSSW SD9S/T 45x-*M       | P8  | XSH-RSM-2RKM 57                | M31 |
| WSM WKC 57x-*M           | M11 | WSSW WKSX 45x-*M         | P6  | XSH-RSM/2RKM 20                | F57 |
| WSM WKM 25x-*M           | R8  | WSSW WSSW 45x-*M         | P6  | XSH-RSM/2RKM 30                | F57 |
| WSM WKM 57x-*M           | M10 | WST 57x                  | M19 | XSH-RSM/2RKM 40                | F57 |
| WSM WSC 25x-*M           | R9  | WST 57x-*                | M20 | XSH-RSM/2RKM 50                | F57 |
| WSM WSC 57x-*M           | M11 | WSV 48x-*M               | P22 | XSH-RSM/2RKM 60                | F57 |
| WSM WSM 25x-*M           | R8  | WSV 49x-*M               | N8  |                                |     |
| WSM WSM 57x-*M           | M10 | WSV FKFDV 48x-*M         | P23 | <b>Y</b>                       |     |
| WSS 10T-*                | D27 | WSV FKFDV 49x-*M         | N9  |                                |     |
| WSS 12T-*                | D27 | WSV FSFDV 48x-*M         | P23 | YB2-FSM 4.4/2PKG 3M            | V50 |
| WSS 4.4T-*               | D26 | WSV FSFDV 49x-*M         | N9  | YB2-FSM 4.4/2PKG 3M-P7X3       | V50 |
| WSS 4.4T-*/S824          | D26 | WSV RKCX 48x-*M          | P23 | YB2-FSM 4.5-2FKM 4.5           | V50 |
| WSS 4.4T-*/S90           | D26 | WSV RKCX 49x-*M          | N9  | YB2-FSM 4.5-2FKM 4.5-P7X3      | V50 |
| WSS 4.5T-*               | D26 | WSV RKFPV 48x-*M         | P23 | YB2-FSM 4.5-2FKM 4.5/S1063     | V50 |
| WSS 6T-*                 | D26 | WSV RKFPV 49x-*M         | N9  | YBZ2-FSM 4.5/2FKM 4.5/S771     | V50 |
| WSS 84x-*M               | K8  | WSV RKV 48x-*M           | P22 | YBZ2-FSM4.4/2FK4               | V6  |
| WSS 8T-*                 | D27 | WSV RKV 49               | N14 | YBZ2-FSM4.4/2FK4.4/S651        | V6  |
| WSS FKSDE 84x-*M         | K9  | WSV RKV 49x-*M           | N8  | YBZ2-FSM4.4/2PKG3M-*/*         | V6  |
| WSS FSSDE 84x-*M         | K9  | WSV RSCV 48x-*M          | P22 | YBZ2-FSM4.4/2RK4.4T-*/*/S651   | V6  |
| WSS RJ45S 84x-*M         | K9  | WSV RSCV 49x-*M          | N8  | YBZ2-FSM4.4/2RK4T-*/*          | V6  |
| WSS RJ45SMIP67 84x-*M    | K9  | WSV RSFPV 48x-*M         | P23 | YBZ2-FSM4.5/2FK4.5/S651        | V6  |
| WSS RKS 84x-*M           | K8  | WSV RSFPV 49x-*M         | N9  | YBZ2-PSG3M-*/2PKG3M-*/*/S651   | V8  |
| WSS RSS 84x-*M           | K8  | WSV WKCX 48x-*M          | P23 | YBZ2-PSG4M-*/2PKG3M-*/*        | V8  |
| WSS WKS 84x-*M           | K8  | WSV WKCX 49x-*M          | N9  | YBZ2-PX3-FSM 4.5/2FKM 4.5      | V50 |
| WSS WSS 84x-*M           | K8  | WSV WKV 48x-*M           | P22 | YBZ2-PX3-FSM4.4/2FK4           | V6  |
| WSSD 44x-*M              | K18 | WSV WKV 49x-*M           | N8  | YBZ2-RS4.4T-*/2RK4.4T-*/*/S651 | V8  |
| WSSD FKSDED 44x-*M       | K19 | WSV WSCV 48x-*M          | P23 | YBZ2-RS4.4T-*/2RK4T-*/*        | V8  |
| WSSD FSSDED 44x-*M       | K19 | WSV WSCV 49x-*M          | N9  | YBZ2-RS4.5T-*/2RK4.5T-*/*/S651 | V8  |
| WSSD RJ45S 44x-*M        | K19 | WSV WSV 48x-*M           | P22 | YBZ2-RS4.5T-*/2VAS22-A653-*/*  | V8  |
| WSSD RJ45SMIP67 44x-*M   | K19 | WSV WSV 49x-*M           | N8  | YP2-MFS 4/2MFK 3               | V36 |
| WSSD RKSD 44x-*M         | K18 | WWAKW 4.5T-*             | D34 | YP2-MFS3/2PKG3M-*/*/S651       | V38 |
| WSSD RSSD 44x-*M         | K18 | WWAKW 4.5T-*/S101        | D34 | YP2-MFS4/2PKG3M-*/*            | V38 |
| WSSD WKSD 44x-*M         | K18 | WWAKW 4.5T-*/S618        | D34 | YP2-MFS4/2PKG4M-*/*/S651       | V38 |
| WSSD WRJ45ES 44x-*M      | K19 | WWAKW 4.5T-*/S653        | D34 | YP2-PSG3M-*/2PKG3M-*/*/S651    | V40 |
| WSSW 45x-*M              | P6  | WWAKW 4T-*/S626          | D34 | YP2-PSG4M-*/2PKG3M-*/*         | V40 |
| WSSW D9S WKSX 45x-*M-*M  | P9  | WWASW 4.5T-*             | D34 | YP2-PSG4M-*/2PKG4M-*/*/S651    | V40 |
| WSSW D9S WSSW 45x-*M-*M  | P9  | WWASW 4.5T-*/S101        | D34 | YP2-PSG4M-*/2RK4T-*/*          | V42 |
| WSSW D9S/T 45x-*M        | P8  | WWASW 4.5T-*/S618        | D34 | YP2-PSG6M-*/2PKG6M-*/*/S651    | V40 |
| WSSW D9SM WKSX 45x-*M-*M | P9  | WWASW 4.5T-*/S653        | D34 | YP2-PX2-MFS 4/2MFK 3           | V36 |



## Warranty Terms and Conditions

### RISK OF LOSS

Delivery of the equipment to a common carrier shall constitute delivery to the Purchaser and the risk of loss shall transfer at that time to Purchaser. Should delivery be delayed due to an act or omission on the part of the Purchaser, risk of loss shall transfer to the Purchaser upon notification by Turck Inc. that the order is complete and ready for shipment.

### WARRANTIES

Turck Inc. (hereinafter "Turck") offers five (5) WARRANTIES to cover all products sold. They are as follows:

- 1) The **12-MONTH WARRANTY** is available for the products listed - generally those not covered by **LIFETIME, 5-YEAR, 24-MONTH or 18-MONTH** warranty. No registration required.
- 2) The **18-MONTH WARRANTY** is available for the products listed - generally those not covered by **LIFETIME or 5-YEAR WARRANTY**. No registration is required.
- 3) The **24-MONTH WARRANTY** is available for the products listed - generally those not covered by **LIFETIME, 5-YEAR or 18-MONTH**. No registration is required.
- 4) The **5-YEAR WARRANTY** is available generally for the products listed. No registration is required.
- 5) A **LIFETIME WARRANTY** is available for the products listed. It becomes effective when the accompanying **TURCK LIFETIME WARRANTY REGISTRATION** is completed and returned to Turck.

### GENERAL TERMS AND CONDITIONS FOR ALL WARRANTIES

- **12-MONTH STANDARD WARRANTY**
- **18-MONTH STANDARD WARRANTY**
- **24-MONTH STANDARD WARRANTY**
- **5-YEAR WARRANTY**
- **LIFETIME WARRANTY**

Turck warrants the Products covered by the respective WARRANTY AGREEMENTS to be free from defects in material and workmanship under normal and proper usage for the respective time periods listed above from the date of shipment from Turck. In addition, certain specific terms apply to the various WARRANTIES.

**THESE EXPRESS WARRANTIES ARE IN LIEU OF AND EXCLUDE ALL OTHER REPRESENTATIONS MADE - BOTH EXPRESSED AND IMPLIED. THERE ARE NO WARRANTIES OF MERCHANTABILITY OR OF FITNESS FOR A PARTICULAR PURPOSE FOR PRODUCTS COVERED BY THESE TERMS AND CONDITIONS.**

Turck warrants that the goods sold are as described, but no promise, description, affirmation of fact, sample model or representation, oral or written shall be part of an order, unless set forth in these terms and conditions, or are in writing and signed by an authorized representative of Turck. These WARRANTIES do not apply to any Product which has been subject to misuse, negligence, or accident - or to any Product which has been modified or repaired, improperly installed, altered, or disassembled - except according to Turck's written instructions.

These WARRANTIES are subject to the following conditions:

- 1) These WARRANTIES are limited to the electronic and mechanical performance only, as expressly detailed in the Product specifications and NOT to cosmetic performance.
- 2) These WARRANTIES shall not apply to any cables attached to, or integrated with the Product. However, the **18-MONTH WARRANTY** shall apply to cables sold separately by Turck.
- 3) These WARRANTIES shall not apply to any Products which are stored, or utilized, in harsh environmental or electrical conditions outside Turck's written specifications.
- 4) The WARRANTIES are applicable only to Products shipped from Turck subsequent to January 1, 1988.

### ADDITIONAL SPECIFIC TERMS FOR:

**(12-MONTH STANDARD WARRANTY)** for Linear Displacement Transducers, EZ Track, RFID Products, Draw Wire Assemblies and Slip Rings.

**(18-MONTH STANDARD WARRANTY)** FOR Q-TRACK INDUCTIVE SENSORS, ULTRASONIC SENSORS, FLOW SENSORS, PRESSURE SENSORS, TEMPERATURE SENSORS, INCLINOMETERS, CABLES AND ALL NON-SENSING PRODUCTS SOLD BY TURCK INC. INCLUDING MULTI-SAFE, MULTI-MODUL, MULTI-CART AND RELATED AMPLIFIER PRODUCTS, RELAYS AND TIMERS.

**(24-MONTH STANDARD WARRANTY)** FOR ENCODERS excluding Draw Wire Assemblies.

**5-YEAR WARRANTY FOR INDUCTIVE AND CAPACITIVE PROXIMITY SENSORS:** The periods covered for the above WARRANTIES and Products shall be 12 MONTHS, 18-MONTHS, 24-MONTHS and 5-YEARS, respectively, from the date of shipment from Turck.

**LIFETIME WARRANTY (OPTIONAL - REGISTRATION REQUIRED)** FOR INDUCTIVE, INDUCTIVE MAGNET OPERATED AND CAPACITIVE PROXIMITY SENSORS SOLD TO THE ORIGINAL PURCHASER FOR THE LIFETIME OF THE ORIGINAL APPLICATION.

# Connectivity Products

## Warranty Terms and Conditions

### **THE FOLLOWING TERMS APPLY TO THE LIFETIME WARRANTY IN ADDITION TO THE GENERAL TERMS:**

- 1) This WARRANTY shall be effective only when the LIFETIME WARRANTY REGISTRATION has been completed, signed by the End User and an authorized Turck Representative or Distributor and has been received by Turck no later than six (6) months after installation in the End User's Plant, or two (2) years from the date product was shipped from Turck, whichever is sooner.
- 2) This warranty is available only to Turck's authorized Representatives, Distributors and to the Original User. (The term "Original User" means that person, firm, or corporation which first uses the Product on a continuous basis in connection with the operation of a production line, piece of machinery, equipment, or similar device.) In the event the ownership of the product is transferred to a person, firm or corporation other than the Original User, this WARRANTY shall terminate.
- 3) This WARRANTY is applicable only to the Original Application. In the event the machinery, equipment, or production line to which the Product is connected, or on which it is installed, is substituted, changed, moved or replaced, the WARRANTY shall terminate.
- 4) This WARRANTY shall be valid only if the Product was purchased by the Original User from Turck, or from an authorized Turck Distributor, or was an integral part of a piece of machinery and equipment obtained by the Original user from an Original Equipment Manufacturer, which itself, was purchased directly from Turck or from an authorized Distributor.

### **PURCHASER'S REMEDIES**

This Remedy shall apply to all WARRANTIES. If a Turck Distributor desires to make a WARRANTY Claim, the Distributor shall, if requested by Turck, ship the Product to Turck's factory in Minneapolis, Minnesota, postage or freight prepaid. If the User desires to make a WARRANTY Claim, they shall notify the authorized Turck Distributor from whom it was purchased or, if such Distributor is unknown, shall notify Turck. Turck shall, at its option, take any of the following two courses of action for any products which Turck determines are defective in materials or workmanship.

- 1) Repair or replace the Product and ship the Product to the Original Purchaser or to the authorized Turck Distributor, postage or freight prepaid; or
- 2) Repay to the Original Purchaser that price paid by the Original Purchaser; provided that if the claim is made under the LIFETIME WARRANTY, and such Product is not then being manufactured by Turck, then the amount to be repaid by Turck to the Original Purchaser shall be reduced according to the following schedule:

| <b><u>Number of Years Since Date of Purchase by Original Purchaser</u></b> | <b><u>Percent of Original Purchase Price To Be Paid by Turck</u></b> |
|--|--|
| 10   | 50%  |
| 15   | 25%  |
| 20   | 10%  |
| More than 20   | 5%   |

**PURCHASER'S REMEDIES SHALL BE LIMITED EXCLUSIVELY TO THE RIGHT OF REPLACEMENT, REPAIR OR REPAYMENT AS PROVIDED AND DOES NOT INCLUDE ANY LABOR COST OR REPLACEMENT AT ORIGINAL PURCHASER'S SITE. TURCK SHALL NOT BE LIABLE FOR ANY CONSEQUENTIAL DAMAGES RESULTING FROM ANY BREACH OF ANY WARRANTY, EXPRESSED OR IMPLIED, APPLICABLE TO THE PRODUCT, INCLUDING WITHOUT LIMITATION, ANY DAMAGES RESULTING FROM PROPERTY DAMAGE, PERSONAL INJURY OR BUSINESS INTERRUPTION.**

### **CONSIDER SAFETY AND PROTECTION PRECAUTIONS**

Turck takes great care to design and build reliable and dependable products, however, some products can fail eventually. You must take precautions to design your equipment to prevent property damage and personal injury in the unlikely event of failure. As a matter of policy, Turck does NOT recommend the installation of electronic controls as the sole device FOR THE PROTECTION OF PERSONNEL in connection with power driven presses, brakes, shears and similar equipment and, therefore, the customer should build in redundancy or dual control using approved safety devices for these applications.

# TURCK PRODUCTS

Turck Inc. sells its products through authorized distributors. These distributors provide our customers with technical support, service and local stock. Turck distributors are located nationwide – including all major metropolitan marketing areas.

For application assistance or for the location of your nearest Turck distributor, call:

1-800-544-7769

Specifications in this manual are subject to change with out notice. Turck also reserves the right to make modifications and makes no guarantee of the accuracy of the information contained herein.

Literature and media questions or concerns?  
Contact Turck USA Marketing – [info@turck.com](mailto:info@turck.com)

# TURCK

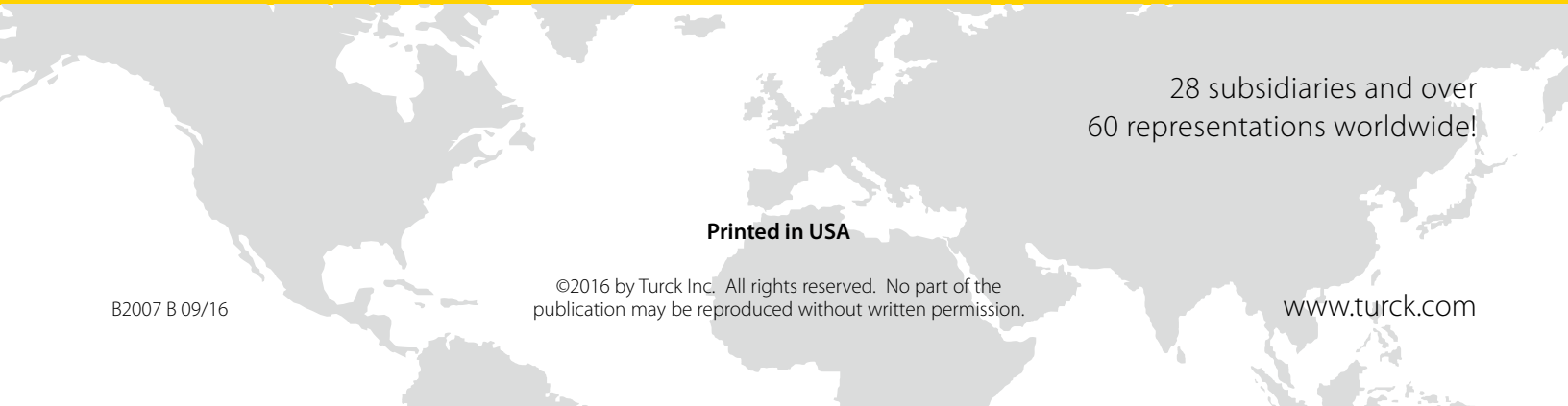

28 subsidiaries and over  
60 representations worldwide!

**Printed in USA**

©2016 by Turck Inc. All rights reserved. No part of the  
publication may be reproduced without written permission.

B2007 B 09/16

[www.turck.com](http://www.turck.com)