

TURCK

**PROCESS
AUTOMATION**

**INTERFACE
& INTRINSIC
SAFETY:
Quick
Reference
Guide**



...Sense It!...Connect It!...Bus It!...Solve It!™

www.turck.us

EXCOM® SYSTEM OVERVIEW



Redundant power supply

Bus address setting via coded rotary switches

I/O modules in various designs

Integrated rails for module mounting, coding

Module rack with backplane

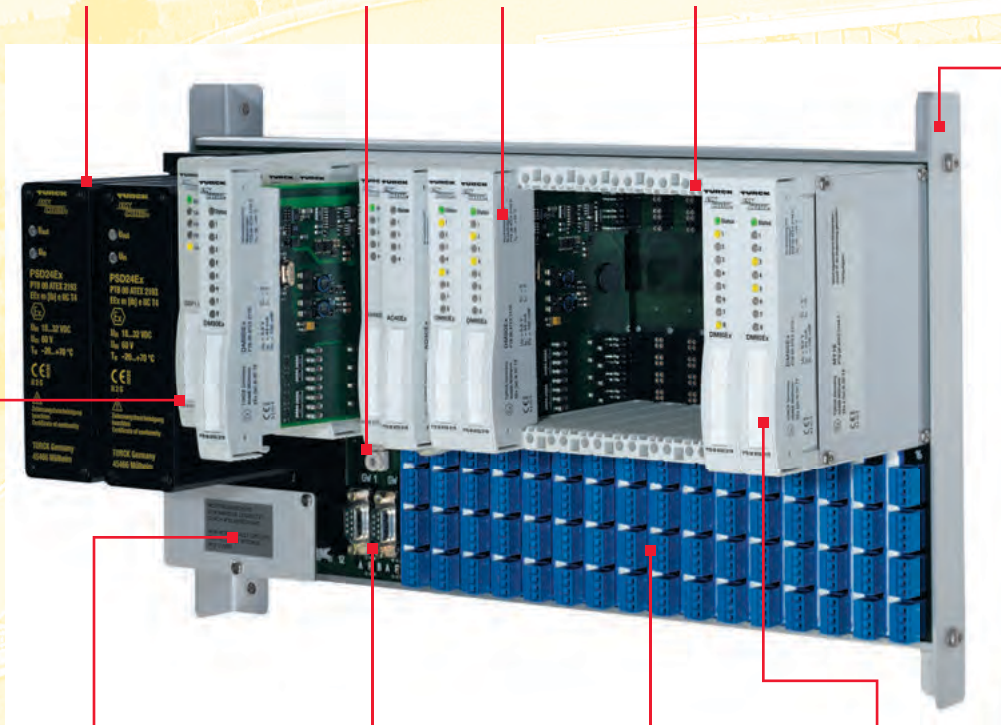

Two redundant gateways possible

Connection of external power supply

Connection of higher-level field bus

Connection of hazardous area devices

Module front cap with mechanical coding

The excom® System

excom is a remote I/O system for use in hazardous locations consisting of power modules, PROFIBUS®-DP communication gateways, I/O modules and a backplane rack. The backplane is available in two sizes, with support for 8 or 16 I/O modules. The larger rack (MT18-) also allows for redundant power supplies and/or PROFIBUS-DP gateway cards.

The I/O modules provide the interface to field devices. The backplane distributes power to the I/O from the power supply, with no need for a separate field supply. The gateways, power supplies and I/O cards are simply plugged into the backplane rack, with all power, PROFIBUS-DP and I/O wiring separate from the removable modules. I/O modules may also be changed during operation ("hot-swappable"). The system automatically checks whether a newly inserted module matches the configuration.

When the excom system is used, the PROFIBUS-DP segment coupler **SC12Ex** must also be used for the interfacing. The coupler is equipped with one standard RS485 interface and two **RS485-IS** interfaces that allow redundancy. Optional fiber-optic couplers are also available.

The excom system, (including the **SC12-Ex** segment coupler) can be mounted in Division 2, Zone 1 or 2 and is FDT/DTM and HART compatible. The field circuits are approved for Division 1 and Zone 0.



Call for cable information

DPC SYSTEM OVERVIEW

The DPC-System (Diagnostic Power Conditioner System) is a power supply system for the installation of **FOUNDATION™ fieldbus** H1 segments. It provides comprehensive diagnostic functions for monitoring FOUNDATION™ fieldbus segments, and supports asset management for the entire system. This includes asset management of the physical layer which is extremely valuable.

A DPC system consists of one or more module racks (**DPC-49-4RMB**) each with up to eight power supply modules (**DPC-49-IPS1**) and one diagnostic module (**DPC-49-ADU**). Up to four H1 segments for each module rack can be operated and monitored redundantly. The diagnostic data from the H1 segments is transmitted via the HSE interface module (**DPC-49-HSEFD/24VDC**) to the higher level asset management system.

The diagnostic module (**DPC-49-ADU**) is used as a communication and diagnostic interface between the H1 segments and the power supply module. The diagnostics module monitors the electrical parameters and the communication parameters of the H1 segments. Operation without diagnostic module is possible. In this configuration, simple diagnostics are provided locally.

The diagnostic information is collected in the device and transmitted via the HSE interface module to the higher fieldbus level (e.g. to the host) as diagnostic and alarm data. The diagnostic module can be plugged and unplugged during operation (hot swappable).

The DPC system provides complete galvanic isolation; H1 to H1, H1 to 24 VDC power, ADU/DU to H1, and HSE to H1. The DPC system can also be used to supply devices in hazardous classified areas when Fisco power supplies/repeaters or multibarriers from TURCK are used.

TURCK extends its diagnostic power conditioner systems (DPC) with a new interface backplane for single **FOUNDATION fieldbus** segments. The new **DPC-49-1RMB** is specially suited for smaller fieldbus installations, and provides a handy alternative to the **DPC-49-4RMB** multi-segment backplanes.

Like the multi-segment backplanes, the new **DPC-49-1RMB** features a redundant power supply, as well as a built-in diagnostics via a system alarm relay contact. Based on the established 800 mA supply **DPC-49-IPS1**, the new backplane supplies power to a single **FOUNDATION fieldbus** segment. Connections to the host system and to the field are provided via removable 3-pin screw terminals.

Communication Signal

The **FOUNDATION fieldbus** H1 communication signal is a square waveform superimposed on a DC carrier. The frequency of the signal is 31.25 KHz. Although it is not a requirement, most devices derive their supply power from the fieldbus communications cable. The fieldbus specification states that devices must not be polarity sensitive. However, it is good electrical practice to have all devices wired with the same polarities. The voltage range allowed for proper operation is 9 to 32 VDC. A typical fieldbus device will consume 20 mA of current.

Fieldbus Cable Specifications

The specifications for fieldbus H1 physical media are defined by IEC 61158-2 and the ISA-550.02 Part 2 Physical Layer Standards. The same standard is also listed in the **FOUNDATION fieldbus** specifications under 31.25 Kbps Physical Layer Profile FF-816-1.4. There are essentially four types of cable designations for fieldbus (see table). Type A cable is preferred for new installations, because it allows for the most versatile lengths. The other cable types are for installations where cable already exists from 4-20 mA systems.

	Type A	Type B	Type C	Type D
Cable Description	Shielded, Twisted Pair	Shielded, Multi-Twisted Pair	Unshielded, Multi-Twisted Pair	Shielded, Untwisted Pair
Conductor Size	18 AWG	22 AWG	26 AWG	16 AWG
Maximum Length	1,900 meters (6,232 feet)	1,200 meters (3,936 feet)	400 meters (1,312 feet)	200 meters (656 feet)

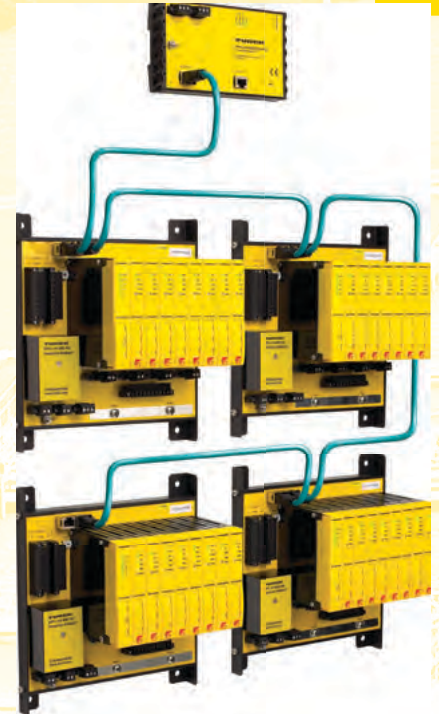

Hazardous Area Descriptions

Class and Groups			
Class	Substance	Group	
		NEC500	NEC505/CENELEC/IEC
Class I (gas)	Acetylene	A	IIC
	Hydrogen	B	
	Ethylene	C	
	Propane	D	
Mining	Methane		I
Class II (dust)	Metal dust	E	Note: See Zones Below
	Coal dust	F	
	Grain dust	G	
Class III (fibers)	Fibers		

Division / Zone			
Flammable Material	NEC500	NEC505	CENELEC/IEC
Continuously Present	Division 1	Zone 0	Zone 0 (Zone 20-dust)
Likely to / Can be Present		Zone 1	Zone 1 (Zone 21-dust)
Not Normally Present	Division 2	Zone 2	Zone 2 (Zone 22-dust)

Temperature		
Maximum Surface Temperature °C	Temperature Class	
	NEC500	NEC505/CENELEC/IEC
450	T1	T1
300	T2	T2
280	T2A	
260	T2B	
230	T2C	
215	T2D	
200	T3	T3
180	T3A	
165	T3B	
160	T3C	
135	T4	T4
120	T4A	
100	T5	
85	T6	T6

NEC500 (Division Method)



NEC505 (Zone Method)

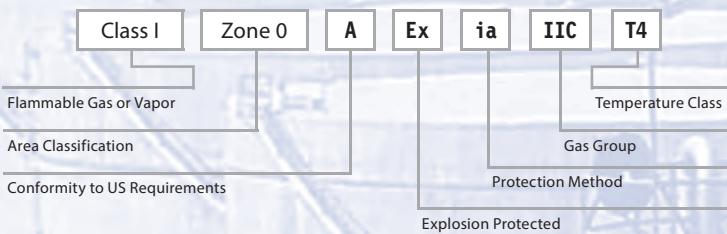

ATEX

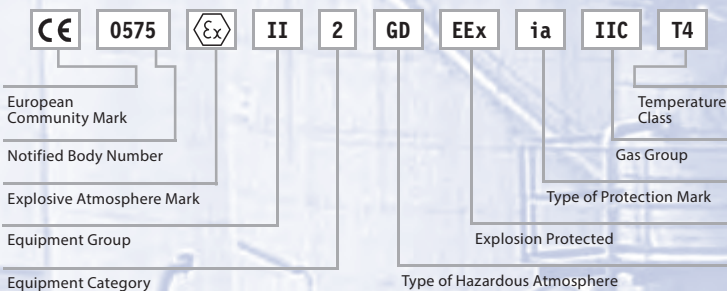

Definitions according to the NEC (national electrical code):

Intrinsically Safe Circuit: A circuit in which any spark or thermal effect is incapable of causing ignition of a mixture of flammable or combustible material in air under prescribed conditions. (NEC 504-2).

Simple Apparatus: An electrical component or combination of components of simple construction with well-defined electrical parameters that does not generate more than 1.5 volts, 100 milliamps, and 25 milliwatts, or a passive component that does not dissipate more than 1.3 watts and is compatible with the intrinsic safety of the circuit in which it is used.

Note: For further assistance please call Application Support: 1-800-544-7769

SWITCH AMPLIFIERS

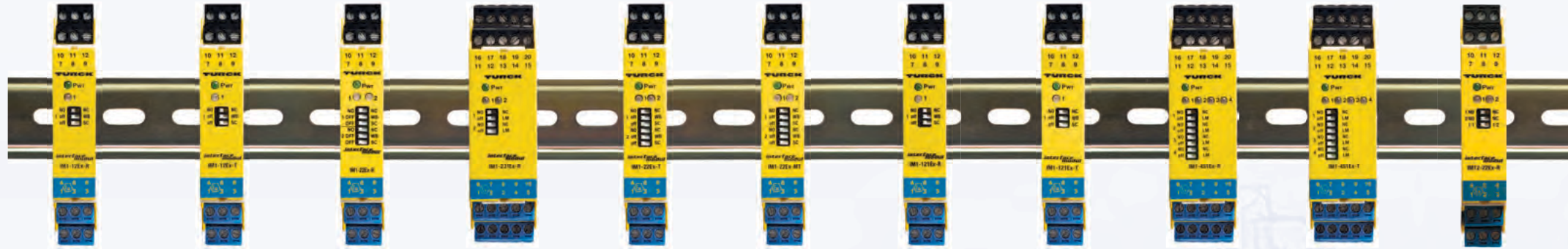

	IM1-12Ex-R	IM1-12Ex-T	IM1-22Ex-R	IM1-231Ex-R	IM1-22Ex-T	IM1-22Ex-MT	IM1-121Ex-R	IM1-121Ex-T	IM1-451Ex-R	IM1-451Ex-T	IM12-22Ex-R
Voltage Supply	20-250 VAC 20-125 VDC	20-250 VAC 20-125 VDC	20-250 VAC 20-125 VDC	20-250 VAC 20-125 VDC	20-250 VAC 20-125 VDC	20-250 VAC 20-125 VDC	20-250 VAC 20-125 VDC	20-250 VAC 20-125 VDC	20-250 VAC 20-125 VDC	20-250 VAC 20-125 VDC	20-250 VAC 20-125 VDC
Inputs	1 NAMUR sensor or contact	1 NAMUR sensor or contact	2 NAMUR sensors or contacts	2 NAMUR sensors or contacts	2 NAMUR sensors or contacts	2 NAMUR sensors or contacts	1 NAMUR sensor or contact	1 NAMUR sensor or contact	4 NAMUR sensors or contacts	4 NAMUR sensors or contacts	2 NAMUR sensors or contacts
Outputs	2 SPST Relays	2 transistors	2 SPST Relays	2 SPST Relays and 1 SPST alarm output	2 transistors	2 MOSFET	2 SPST Relays, incl. 1 alarm output	2 transistors incl. 1 alarm output	5 SPST Relays, incl. 1 alarm output	4 transistors incl. 1 alarm output	2 SPST Relays
Approvals	IECEX ATEX, FM C/US, UL	IECEX ATEX, FM C/US, UL	IECEX ATEX, FM C/US, UL	IECEX ATEX, FMC/US	IECEX ATEX, FM C/US, UL	IECEX ATEX, FM C/US, UL	IECEX ATEX, FM C/US, UL	IECEX ATEX, FM C/US, UL	IECEX ATEX, FM C/US, UL	IECEX ATEX, FM C/US, UL	IECEX ATEX, FM C/US, UL

RELAY COUPLER

	IM73-22Ex-R/24VUC
	Relay Coupler
Voltage Supply	10-30 VDC
Inputs	2 Inputs
Outputs	2 SPST Relays
Approvals	ATEX, FMC/US

SOLENOID DRIVERS



	IM72-11Ex/L	IM72-22Ex/L
	Solenoid driver	Solenoid driver
Voltage Supply	19-30 VDC	19-30 VDC
Inputs	1	2
Outputs	1 x 45 mA	2 x 45 mA
Approvals	IECEX ATEX, FM C/US, UL	IECEX ATEX, FM C/US, UL

ANALOG INPUT / OUTPUT



	IM31-11Ex-i	IM31-12Ex-i	IM31-22Ex-U IM31-22Ex-i	IM33-11Ex-Hi/24VDC	IM33-12Ex-Hi/24VDC	IM33-22Ex-Hi/24VDC	IM33-11Ex-Hi	IM33-12Ex-Hi	IM33-22Ex-Hi	IM33-14Ex-CDRi	IM33-FSD-Ex/L	IM34-11Ex-i IM34-11Ex-Ci	IM34-12Ex-Ri	IM34-12Ex-CRi	IM34-14Ex-CDRi	IM35-11Ex-Hi/24VDC	IM35-22Ex-Hi/24VDC	IM36-11Ex-U/24VDC	IM36-11Ex-i/24VDC
	Analog input repeater/converter	Analog input repeater/converter	Analog input repeater/converter	Current repeater transmitter supply	Current repeater transmitter supply	Current repeater transmitter supply	Current repeater transmitter supply	Current repeater transmitter supply	Current repeater transmitter supply	Current set point transmitter supply	Current repeater loop powered	Temperature measuring amplifie	Temperature measuring amplifie	Temperature measuring amplifie	Temperature set point amplifie	Analog output driver	Analog output driver	Potentiometer amplifie	Potentiometer amplifie
Voltage Supply	20-250 VAC 20-125 VDC	20-250 VAC 20-125 VDC	20-250 VAC 20-125 VDC	24 VDC	24 VDC	24 VDC	20-250 VAC 20-125 VDC	20-250 VAC 20-125 VDC	20-250 VAC 20-125 VDC	20-250 VAC 20-125 VDC	without auxiliary energy	20-250 VAC 20-125 VDC	20-250 VAC 20-125 VDC	20-250 VAC 20-125 VDC	20-250 VAC 20-125 VDC	24 VDC	10-30 VDC	24 VDC	24 VDC
Inputs	0/2-10 V 0/4-20 mA	0/2-10 V 0/4-20 mA	2 x 0/2-10 V 2 x 0/4-20 mA	0/4-20 mA	1 x 0/4-20 mA	2 x 0/4-20 mA	1 x 0/4-20 mA	1 x 0/4-20 mA	2 x 0/4-20 mA	1 x 0/4-20 mA FDT/DTM	2 x 0-20 mA	Ni/Pt100 or thermo-elements or mV-input	Ni/Pt100 or thermo-elements or mV-input	Ni/Pt100 or thermo-elements or mV-input - FDT/DTM	Ni/Pt100 or thermo-elements or mV-input - FDT/DTM	0/4-20 mA	2 x 0/4-20 mA	≥ 800 to 20 kΩ	≥ 800 to 20 kΩ
Outputs	0/4-20 mA	2 x 0/4-20 mA	2 x 0/4-20 mA 2 x 0/2-10 V	0/4-20 mA	2 x 0/4-20 mA	2 x 0/4-20 mA	1 x 0/4-20 mA	2 x 0/4-20 mA	2 x 0/4-20 mA	1 x 0/4-20 mA 3 x relay	2 x 0-20 mA	1 x 0/4-20 mA	1 x 0/4-20 mA 1 relay	1 x 0/4-20 mA 1 relay	3 relays 1 x 0/4-20 mA	0/4-20 mA	2 x 0/4-20 mA	0-10 V	0/4-20 mA
Approvals	IECEX, ATEX, FM C/US, UL	IECEX, ATEX, FM C/US, UL	IECEX, ATEX, FM C/US, UL	IECEX ATEX, FM C/US, UL	IECEX ATEX, FM C/US, UL	IECEX ATEX, FM C/US, UL	IECEX ATEX, FMC/US	IECEX ATEX, FMC/US	IECEX ATEX, FMC/US	ATEX, FMC/US, PACTware	IECEX, ATEX, FM C/US	IECEX, ATEX, FM C/US, UL	IECEX, ATEX, FM C/US, UL	IECEX, ATEX, FM C/US, UL	PACTware, IECEX ATEX, FM C/US, UL	IECEX, ATEX, FM C/US, UL	IECEX, ATEX, FM C/US, UL	ATEX, FMC/US	ATEX, FMC/US

ROTATIONAL SPEED MONITORS

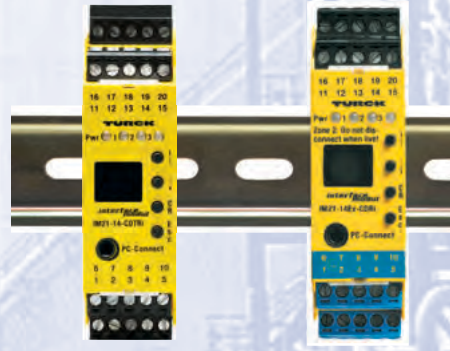

	IM21-14-CDTRi	IM21-14Ex-CDRi
	Rotational Speed Monitor	Rotational Speed Monitor
Voltage Supply	20-250 VAC / 20-125 VDC	20-250 VAC / 20-125 VDC
Inputs	NAMUR input, 3-wire or external input	1 intrinsically safe NAMUR input
Outputs	relay and analog outputs	relay and analog outputs
Approvals	PACTware	FM C/US, ATEX, PACTware

SET POINT MODULES



	IM43-13-R	IM43-13-SR	IM43-14-SRi	IM43-14-Ri	IM43-14-CDRi
	Limit value monitor	Limit value monitor	Limit value monitor	Limit value monitor	Limit value monitor
Voltage Supply	20-250 VUC	20-250 VUC	20-250 VUC	20-250 VUC	20-250 VUC
Inputs	0/4-20 mA or 0/2-10 V or transmitter	0/4-20 mA or 0/2-10 V or transmitter	0/4-20 mA or 0/2-10 V or transmitter	0/4-20 mA or 0/2-10 V or transmitter	0/4-20 mA or 0/2-10 V or transmitter
Outputs	3 relays (N.O.)	3 relays (N.O.)	3 relays (N.O.) 1 x 0/4-20 mA	3 relays (N.O.) 1 x 0/4-20 mA	1 x 0/4-20 mA
Approvals	FM, CI, D2	FM, CI, D2	FM, CI, D2	FM, CI, D2	PACTware

POWER SUPPLIES



	IM82-2414/94-265VAC	IM82-24-2.5	IM82-24-5.0	IM82-24-10	IM82-24-20
	Power supply	Power supply	Power supply	Power supply	Power supply
Voltage Supply	85-265 VAC 210-375 VDC	100-240 VAC	115-230 VAC	115-230 VAC	115-230 VAC
Voltage Output	24 VDC / 1.4 A	24 VDC/2.5 A	24 VDC/5 A	24 VDC/10 A	24 VDC/20 A
Approvals	-	UL	UL CID2	UL CID2	UL CID2

IMC INTERFACE MODULE CARTRIDGES



TURCK'S new interface module cartridge (IMC) series is another innovative breakthrough in process automation: The I.S. barrier is moved from the mounting cabinet directly to the installation, thus making it possible to create further decentralized structures in the installation.

The exceptional compact and rugged device series creates new options and possibilities for the user: In addition to your standard mounting cabinet solution, increase the flexibility of your system by using TURCK interface module cartridges.

- IP 67 protection with screw on connectors
- Mounting in Zone 2 - Application area in accordance with ATEX: II (1) GD, II (3) GD
- Ambient temperature -25° to +70°C
- Standard signals
- Plug & play connection technology, M12 connectors

Part Number	Description
IMC-Di-22Ex-PNO/24 VDC (NO = normally open)	NAMUR sensor, contact with resistor circuitry
IMC-Di-22Ex-PNC/24VDC (NC = normally closed)	NAMUR sensor, contact with resistor circuitry
IMC-Ai-11Ex-i/24VDC	Active transmitter; Current source
IMC-AiA-11Ex-i/24VDC	Passive 2-wire transmitter; Current sink
IMC-A0-11Ex-i/24VDC	Analog actuator, positioner, display
IMC-DO-11Ex/L	Pilot light, solenoid valve, 4-wire transmitter
IMC-SG	Cover guard

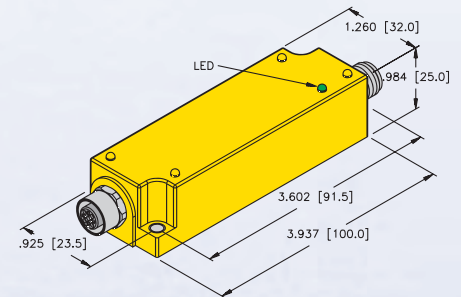

IMS SIGNAL CONDITIONERS



TURCK introduces the new IMS interface module measuring merely 6.2 mm wide. The module may be configured with a laterally mounted DIP switch for added convenience.

This extremely compact module provides complete galvanic isolation, up to 2.5 kV between the input, output and power supply. Galvanically isolated IMS modules

are available with dead-zero to live-zero signal conditioning, or one and two channel modules are available without signal conditioning.

Modules are also available for temperature detection using **Pt-100** technology or other thermo-elements. Those that use **Pt-100** technology achieve 0.3 percent of the full scale, and are available with 2-, 3- or 4-wire connections. An analog signal transmitter that achieves 0.1 percent of the full scale completes the IMS line.

Applications:

- Signal conditioning
- Analog conversion
- Temperature measurement
- UL, Division 2 approved

Part Number	Description
IMS-AI-DI-DI/24VDC	0-20 mA to 0-20 mA
IMS-AI-DI-DU/24VDC	0-20 mA to 0-10 V
IMS-AI-DI-LI/24VDC	0-20 mA to 4-20 mA
IMS-AI-DLI-22-DLI/L	0/4 to 20 mA loop powered dual channel
IMS-AI-DU-DI/24VDC	0-10 V to 0-20 mA
IMS-AI-DU-DU/24VDC	0-10 V to 0-10 V
IMS-AI-DU-LI/24VDC	0-10 V to 4-20 mA
IMS-AI-LI-DI/24VDC	4-20 mA to 0-20 mA
IMS-AI-LI-DU/24VDC	4-20 mA to 0-10 V
IMS-AI-LI-LI/24VDC	4-20 mA to 4-20 mA
IMS-AI-UNI/24VDC	Universal mA/V selectable
IMS-TI-J/24VDC	Type J thermocouple to mA/V
IMS-TI-K/24VDC	Type K thermocouple to mA/V
IMS-TI-PT100/24VDC	Pt-100 RTD to mA/V

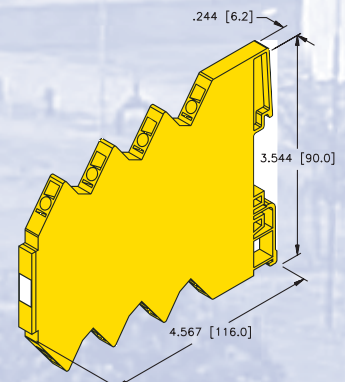

Interface Modules with FDT/DTM

To simplify device set-up and installation time, TURCK'S interface module (IM) family may now be programmed via a pc or on-board push buttons using FDT/DTM software, along with PACTware. This software allows multiple parameters to be set and saved in a matter of seconds. The ease of use and structure of this system allows asset management ability with trending and data logging of values.

TURCK'S IM modules may be used to monitor the speed of motors, shafts and conveyors, the temperature of RTD's and thermocouples, and to control or monitor analog signals for linear movement, temperature, pressure, level control or any other device using 4 to 20 mA signals. Intrinsically safe models to control devices in hazardous areas are also available.

All models are equipped with a two-line transreflective LCD display, making it easy to read even in very bright light. The modules also incorporate a universal supply voltage and removable terminals, making them easy to install in new or existing systems.



ZENER Diode Barriers

- Temperature monitoring and control of equipment and their surrounding areas with RTD's and thermocouples
- Load cells
- Control and monitor 4-20 mA transmitters
- Control or monitor all other analog signals for linear movement, temperature, pressure, level control or any other device using 4-20 mA signal feedback



NAMUR Sensors and Junctions

- Class I, Class II, Class III, Division 1 and Division 2 FM approved
- Full line of inductive, capacitive and magnet operated inductive sensors
- Numerous sizes and styles are available
- Eliminates multiple cable runs for wiring IS applications



Intrinsically Safe Pressure Transmitters

- **PT4300** pressure transmitters are UL/cUL 1604 (CSA 213) Class I, Division 2, Groups A, B, C and D approved for hazardous area applications.
- **PT4400** pressure transmitters are UL/cUL 913 Class I, Division 1, Groups C and D approved when installed with an approved barrier, such as the IM33 isolation module.
- **PT4300** and **PT4400** sensors incorporate a 316 stainless steel measuring element that permits ranges from 0-10,000 psi, with high burst pressures up to 20,000 psi.
- **PT4500** submersible level transmitter is Class I, Division 1 approved when installed with an approved barrier, such as the IM33 isolation module.



Intrinsically Safe R16 Level Probes

- Rated for FM Class I, Division 1 areas



USA

TURCK Inc.
3000 Campus Drive
Minneapolis, MN 55441
Phone: (763) 553-7300
Fax: (763) 553-0708
Application Support:
1-800-544-7769



MEXICO

TURCK MEXICO S. DE R.L. DE C.V.
Carr. Saltillo-Zacatecas km 4.5 s/n
Parque Industrial "La Angostura"
Saltillo, COAH. C.P. 25070
Mexico
Phone: +52 (844) 411-6647/46
Fax: +52 (844) 482-6926
Local Toll Free: 01-800-01-88725
E-mail: ventasmexico@turck.com



CANADA

CHARTWELL ELECTRONICS, INC.
140 Duffield Drive
Markham, Ontario
Canada, L6G 1B5
Phone: (905) 513-7100
Fax: (905) 513-7101
Toll Free: 1-877-513-7769



GERMANY

WORLD HEADQUARTERS
Hans TURCK GmbH & Co. KG
Witzlebenstrasse 7
D-45472 Muelheim an der Ruhr
Federal Republic of Germany
Phone: (+49) 208-49 52-0
Fax: (+49) 208-49 52 264



AUSTRALIA

TURCK Australia Pty. Ltd.
Unit 5, 6-7 Gilda Court
Mulgrave, Victoria 3170
Australia
Phone: (+61) 3 9560 9066
Fax: (+61) 3 9560 1620
Local Toll Free: 1300 132566
E-mail: turckaustralia@turck.com

www.turck.us

©2011 by TURCK Inc. All rights reserved.
No part of the publication may be
reproduced without written permission.