

Safety Solutions

BANNER[®]
more sensors, more solutions





Contents

Complete Safety Solutions from Banner 4

Hand and Finger Detection

Type 4 Heavy-Duty Light Curtains 6

Type 4 Compact Light Curtains 7

Safety Light Curtains – Selection 8

Safety Light Curtains – Model Keys 10

Safety Light Curtains – Accessories 13

Body Detection

Type 4 Safety Light Grids 14

Muting Options for Safety Light Grids 15

Safety Light Grids – Selection 16

Safety Light Grids – Models Keys 18

Safety Light Grids – Accessories 19

Area Detection

Safety Scanner System 20

Safety Scanner System – Software 22

Safety Scanner System – Models and Accessories 23

Safety Relays and Controllers

Safety Relays and Controllers – Overview 24

Safety Relays and Controllers – Software 26

Safety Relays and Controllers – Models 29

Safety Relays and Controllers – Selection 30

Safety Switches

Safety Switches – Overview 32

Non-Contact Safety Switches 33

Safety Switches – Selection 34

Enabling

Emergency Stop Buttons 36

Rope Pull E-Stop Devices and Switches 37

Two-Hand Control 38

Two Hand Control Run Bars 39

Enabling Devices 39



Complete Safety Solutions from Banner



EZ-SCREEN LS Safety Light Curtains

- Intuitive and easy-to-use and set up
- End-to-end sensing
- Heavy-duty aluminum housing and recessed window to avoid damage in harsh environments
- Highly visible alignment and diagnostic indicators
- IP69 Hygienic models available for washdown environments
- Cascade capable models available
- See page 6

XS26-2

Expandable Safety Controllers

- Up to eight expansion I/O modules can be added as your safety application grows or changes
- Configuration software is so simple that you will be programming in minutes
- Simulator functionality allows users to test their configurations without being connected to a controller
- See page 25

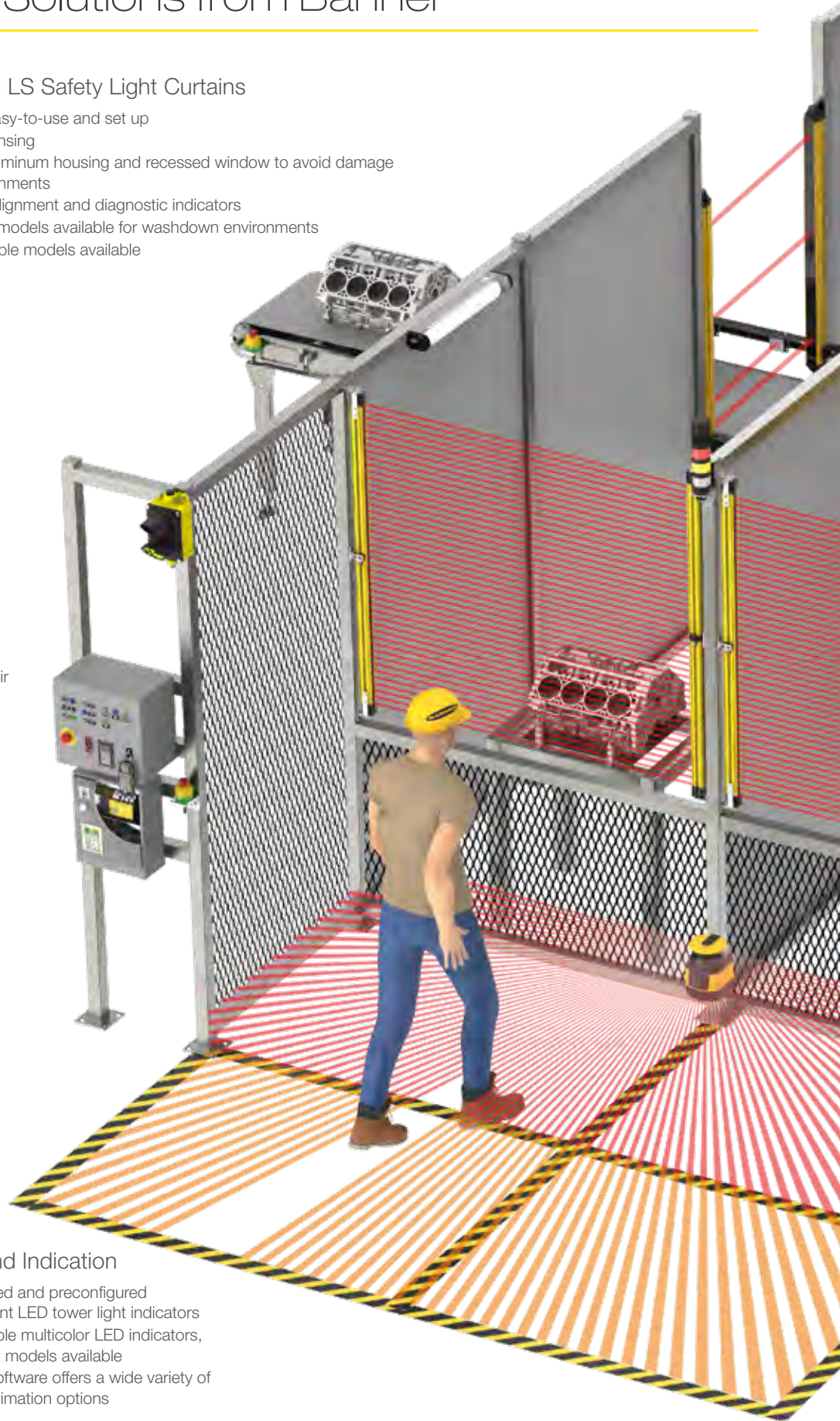

Lighting and Indication

- Preassembled and preconfigured multi-segment LED tower light indicators
- Programmable multicolor LED indicators, panel mount models available
- Pro Editor software offers a wide variety of color and animation options

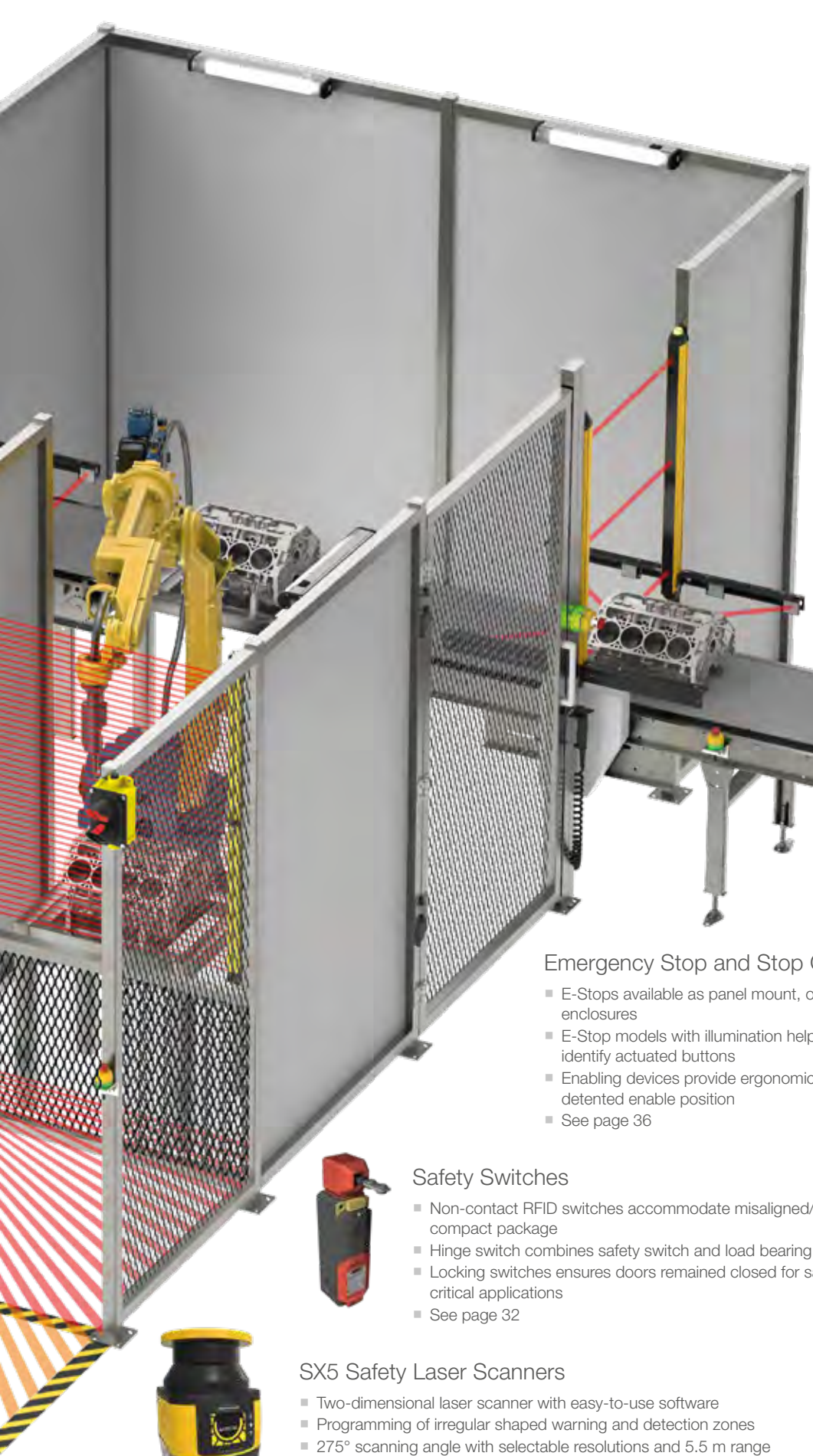

SGS Safety Grid Systems

- Multiple beam safety light devices for access and long-range perimeter guarding
- Available in emitter/receiver models and in easy-to-deploy active/passive models
- Heavy-duty aluminum housing for tough environments
- Easy alignment and installation with on-board alignment lamp and indicators
- Muting arm kits available to simplify end-of-line packaging applications
- See page 14

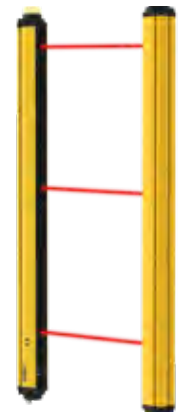

Emergency Stop and Stop Control

- E-Stops available as panel mount, or as preassembled enclosures
- E-Stop models with illumination help operators to quickly identify actuated buttons
- Enabling devices provide ergonomic design with a detented enable position
- See page 36



Safety Switches

- Non-contact RFID switches accommodate misaligned/vibrating doors in a compact package
- Hinge switch combines safety switch and load bearing hinge in a single package
- Locking switches ensures doors remained closed for safety and process critical applications
- See page 32



SX5 Safety Laser Scanners

- Two-dimensional laser scanner with easy-to-use software
- Programming of irregular shaped warning and detection zones
- 275° scanning angle with selectable resolutions and 5.5 m range
- See page 20



Type 4 Heavy-Duty Light Curtains

Robust safety light curtains for harsh industrial environments

Banner Engineering's easy-to-use, heavy-duty Type 4 safety light curtains with several resolution options available to detect fingers, hands, arms, or legs. Our heavy duty light curtains are built to withstand harsh industrial environments.



Due to its robust design, the EZ-SCREEN LS is the perfect fit in large robotic cell applications that require sturdy safety devices and heavy duty enclosures.



EZ-SCREEN LS light curtains in hygienic tubular enclosures successfully protect operators from injury and remain hygienic for easy cleaning procedures.

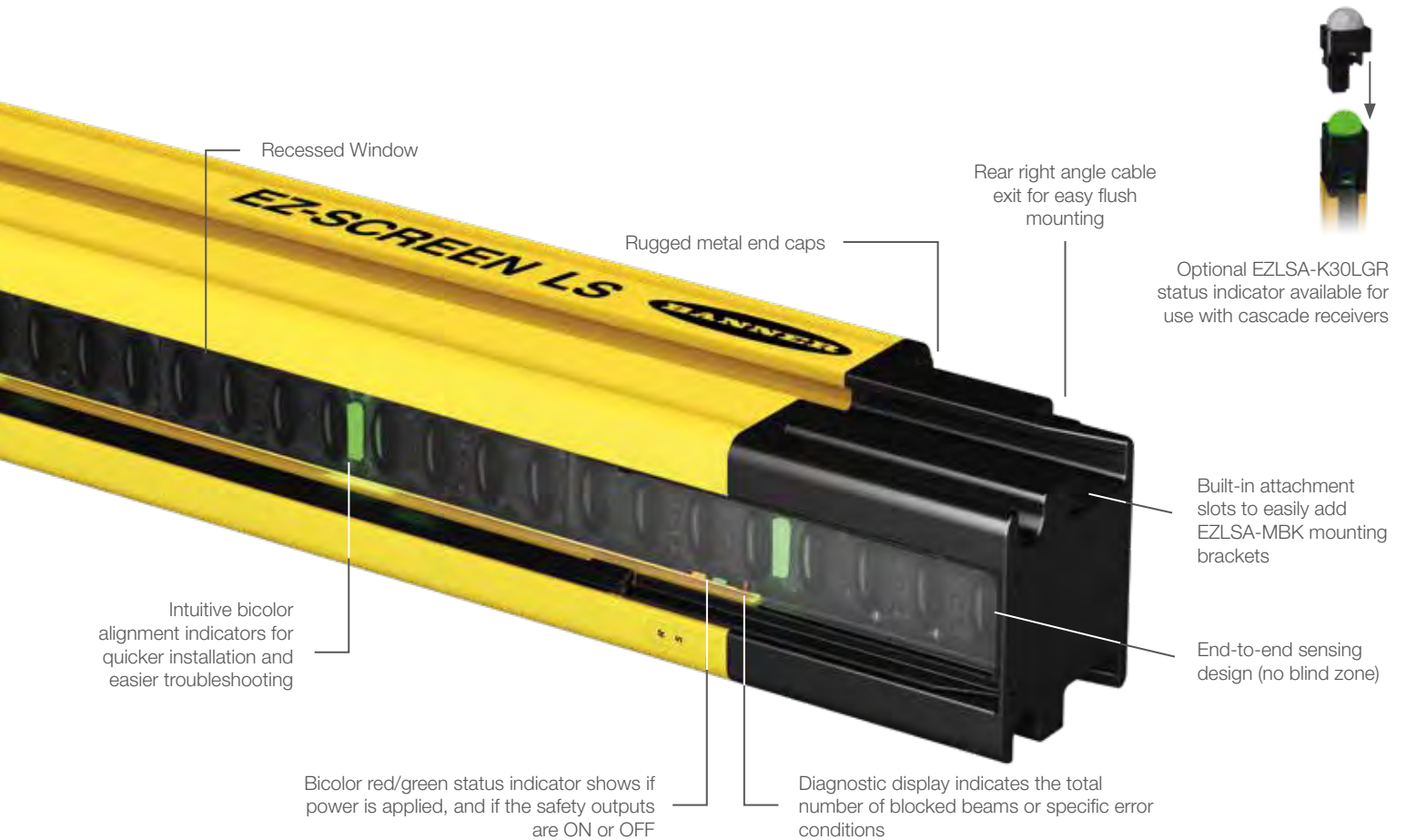

Type 4 Compact Light Curtains

Compact safety light curtains for safety in tight spaces

Banner Engineering's easy-to-use, compact Type 4 safety light curtains are available with several resolution options available to detect fingers, hands, arms, or legs. Our compact safety light curtains are ideal for smaller machines and other space-constrained areas.

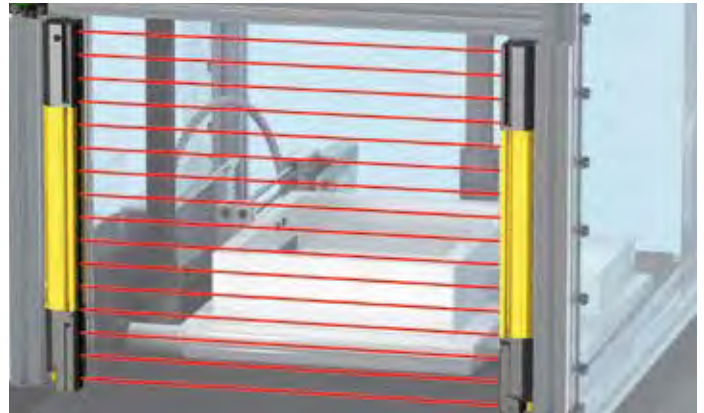
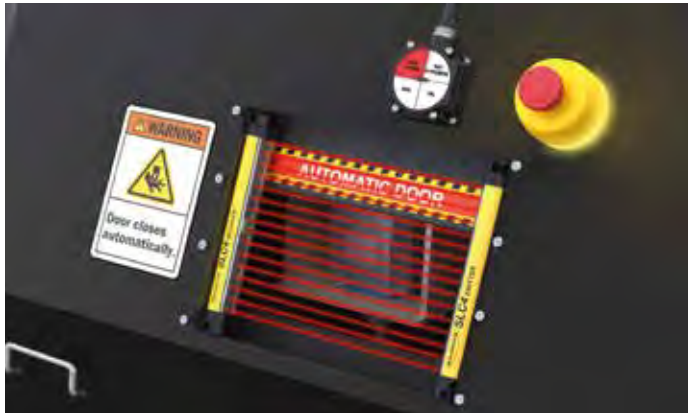

SLC4 are Type 4 safety light curtains specifically designed to safeguard smaller points of operation and access on compact machines.

The EZ-SCREEN LP safety light screen is compact and mounts in tight spaces with its continual end-to-end sensing that leaves no gaps.

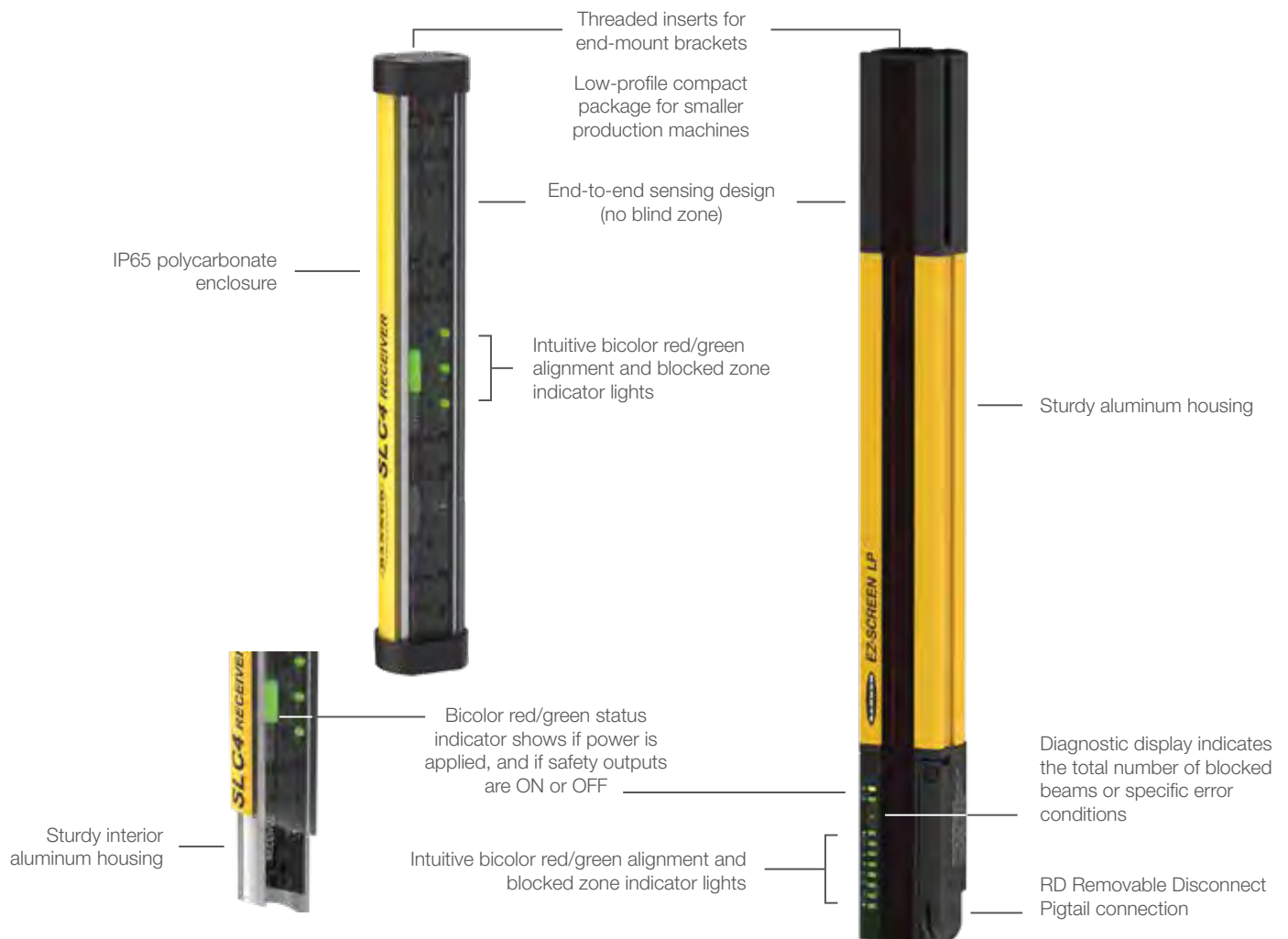

Safety Light Curtain Selection

Choose your safety light curtain, suitable for a wide variety of safety applications.

- Heavy-Duty Type 4 robust safety light curtains for harsh industrial environments
- Compact Type 4 safety light curtains for safety in tight spaces
- Type 2 cost-effective safety light curtains for lower risk applications

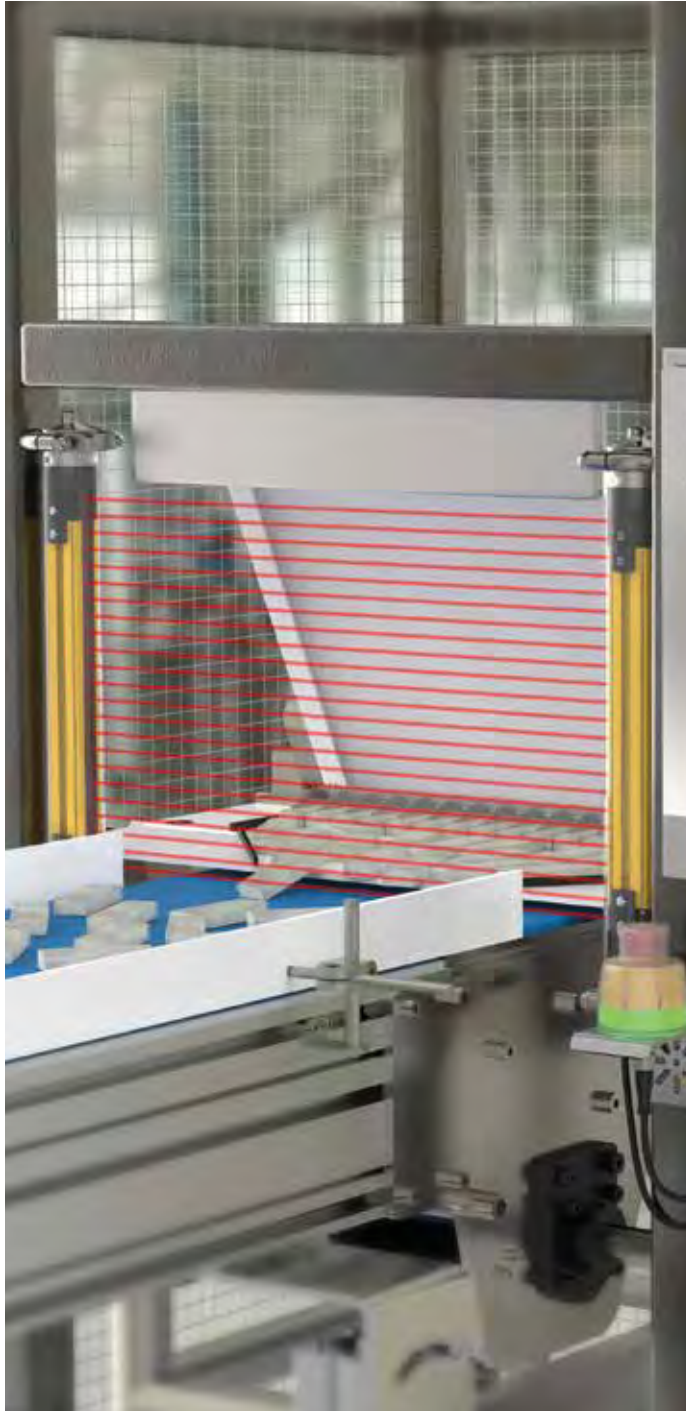

Compact Type 4

	SLC4	EZ-SCREEN LP Basic
Finger Detection		
Hand Detection		
Muting/Presence Detection		
Family	SLC4	SLPVA
Type IEC 61496-1, -2	Type 4	Type 4
Safety Rating EN ISO 13849-1; IEC 61508; IEC 62061	Category 4 PL e; SIL3; SIL CL3	Category 4 PL e; SIL3; SIL CL3
Dimensions W x D (mm)	26.7 x 22.1	28 x 26
Resolution (mm)	14, 24 mm	14, 25 mm
Max Sensing Range (m)	0.1 to 2 m	0.1 to 4 m
Defined Area (mm)	160 mm 240 mm 320 mm	270, 410, 550, 690 mm
Increments (mm)	Not applicable	Not applicable
Reset	–	–
EDM	–	–
Scan Code	–	–
Reduced Resolution	–	–
Fixed Blanking	–	–
Integrated Muting	–	–
Cascade	–	–
E-Stop/Safety Switch Connect	–	–
Brackets Included	–	–
Connection	4-pin Integral Pigtail M12 Included	5-pin Pigtail M12 or 8-pin Pigtail M12 Order separately
LED on Top	–	–
Different Housing	–	–
Available Finishing	–	–

Compact Type 4		Heavy-Duty Type 4			Type 2
EZ-SCREEN LP	EZ-SCREEN LP with Muting	EZ-SCREEN LS Basic	EZ-SCREEN LS	EZ-SCREEN	EZ-SCREEN
SLP	SLPMP	SLLV	SLL	SLS	LS2
Type 4	Type 4	Type 4	Type 4	Type 4	Type 2
Category 4 PL e; SIL3; SIL CL3	Category 4 PL e; SIL3; SIL CL3	Category 4 PL e; SIL3; SIL CL3	Category 4 PL e; SIL3; SIL CL3	Category 4 PL e; SIL3; SIL CL3	Category 2 PL c
28 x 26	28 x 26	36 x 45	36 x 45	36 x 45.2	25.4 x 31.8
14, 25 mm	14, 25 mm	23 mm	14, 23, 40 mm	14, 30 mm	30 mm
0.1 to 7 m	0.1 to 7 m	0.1 to 8 m	0.1 to 12 m	14: 0.1 to 6 m 30: 0.1 to 18 m	0.2 to 15 m
270 to 1250 mm	410 to 1250 mm	350, 420, 630, 910, 1050, 1190, 1260, 1330, 1540, 1820 mm	280 to 1820 mm	14: 150 to 1800 mm 30: 150 to 2400 mm	150 to 1800 mm
140 mm	140 mm	Not applicable	70 mm	150 mm	150 mm
Functions					
✓	✓	–	–	✓	✓
✓	✓	✓	✓	✓	✓
✓	✓	✓	✓	✓	–
✓	✓	–	–	✓	–
✓	✓	–	✓	✓	–
–	✓	–	–	–	–
SLPC	–	–	SLLC	SLSC	–
SLPC	–	–	SLLC	SLSC	–
✓	✓	–	✓	✓	✓
8-pin Pigtail M12 Included or order separately	8-pin Pigtail M12 and 12-pin Pigtail M12 Included or order separately	5-pin Pigtail M12 or 8-pin Pigtail M12 Order separately	5-pin Pigtail M12 or 8-pin Pigtail M12 Included or order separately	8-pin M12 or 8-pin Pigtail M12 Included (Pigtail)	8-pin M12
Options					
–	Accessory	–	Accessory	–	–
–	–	–	EZLSA-HTE IP69	Tubular Enclosures IP67	–
- Yellow Painted Aluminum - Clear Anodized Aluminum - Nickel-Plated ESD	–	–	–	- Yellow Painted Aluminum - Clear Anodized Aluminum - Nickel-Plated ESD	–

Safety Light Curtains – Model Keys

Compact Type 4: SLC4



Compact Type 4: EZ-SCREEN LP Basic

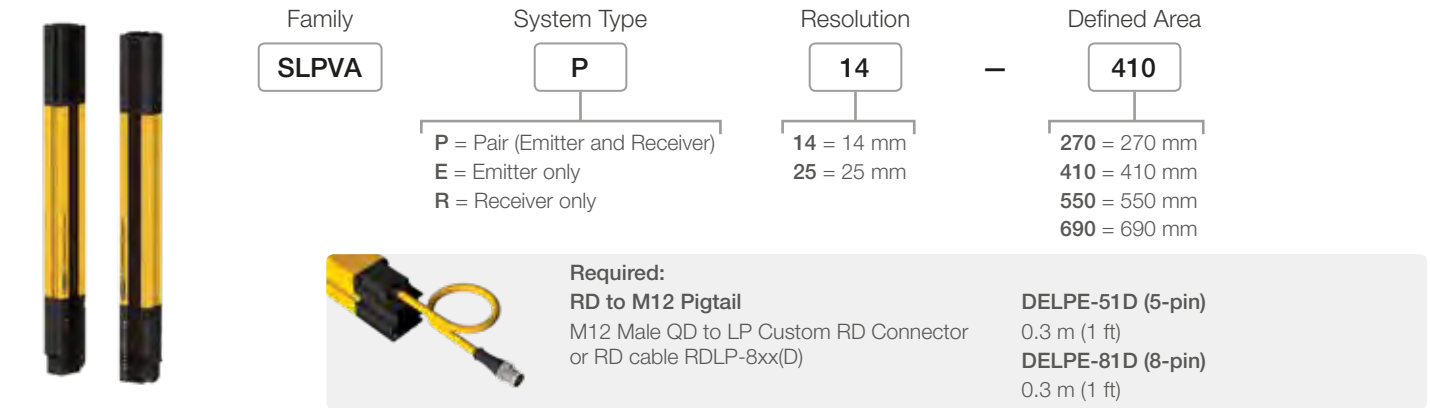

Compact Type 4: EZ-SCREEN LP

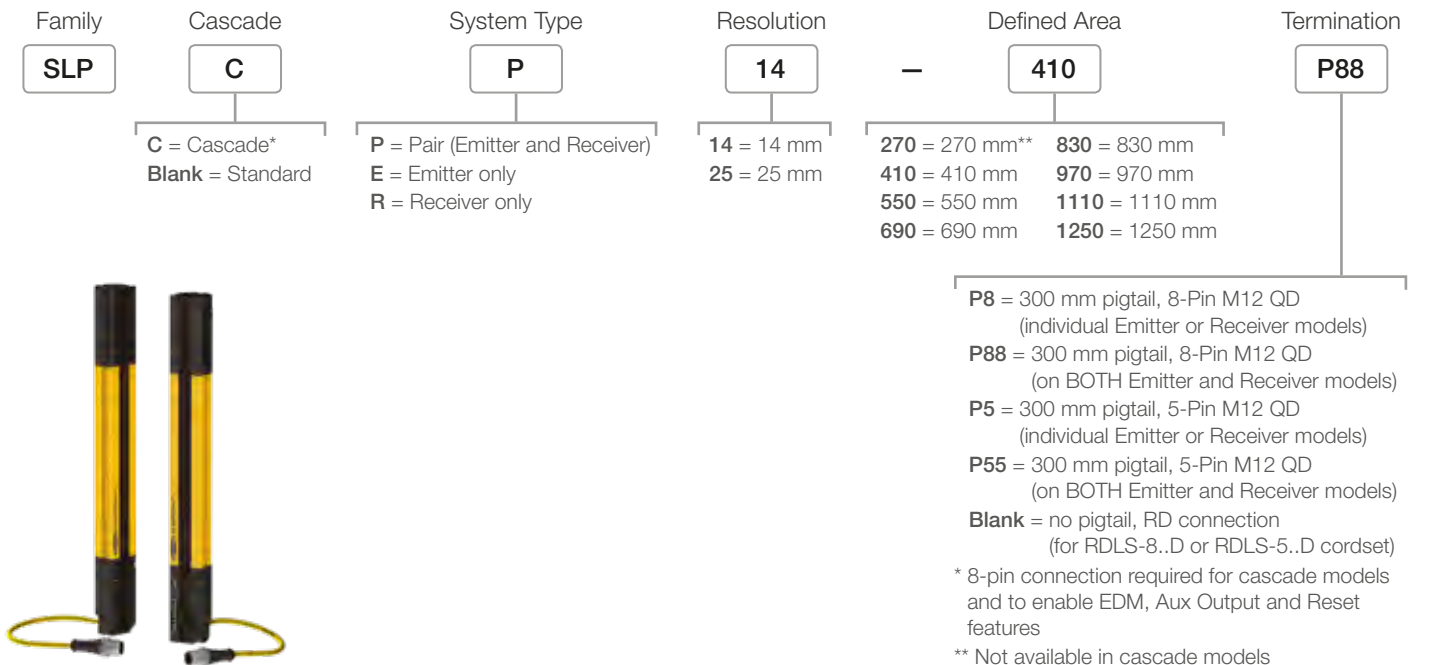

Safety Light Curtains – Model Keys

Compact Type 4: EZ-SCREEN LP with Muting

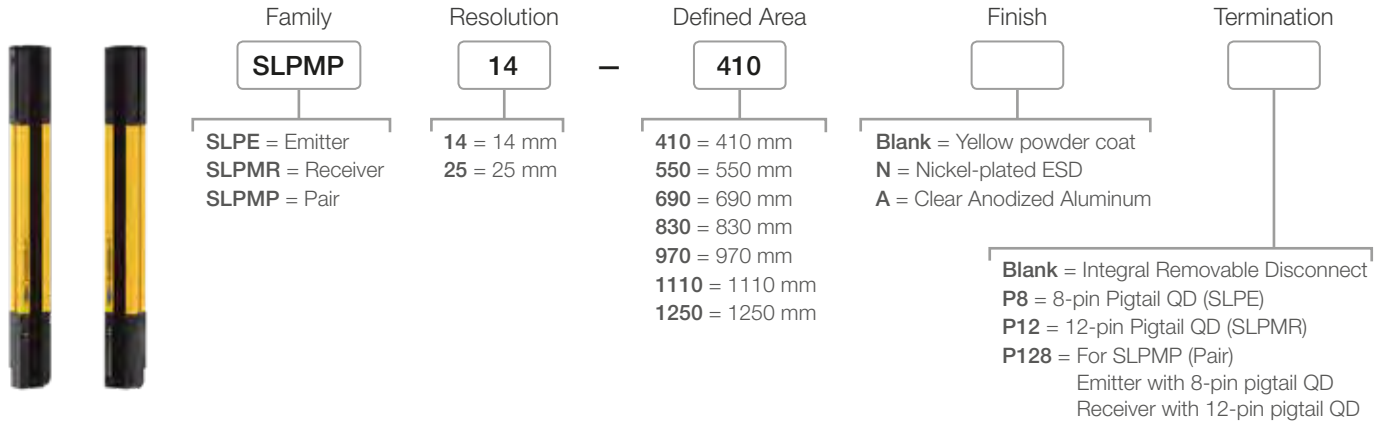

Heavy-Duty Type 4: EZ-SCREEN LS Basic

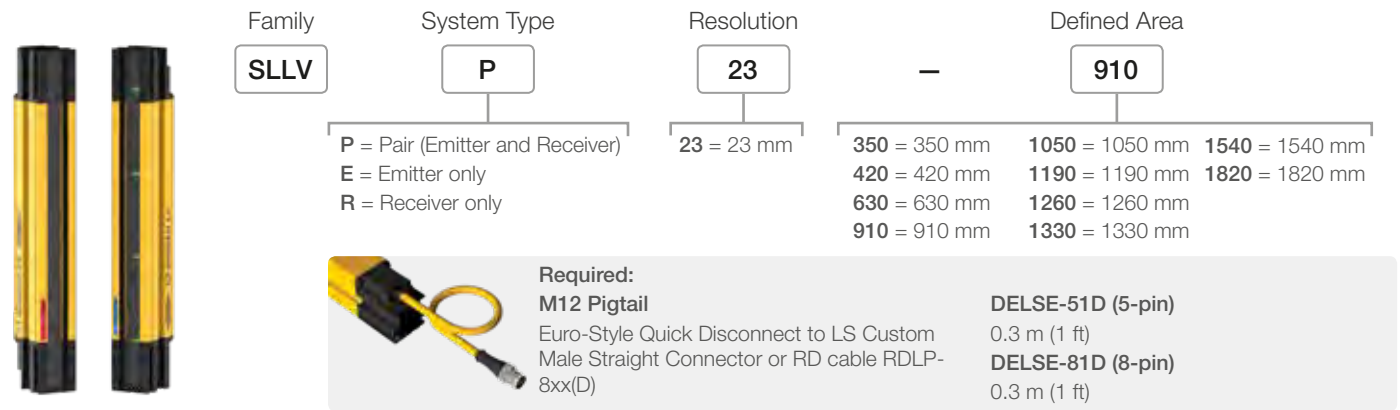

Heavy-Duty Type 4: EZ-SCREEN LS

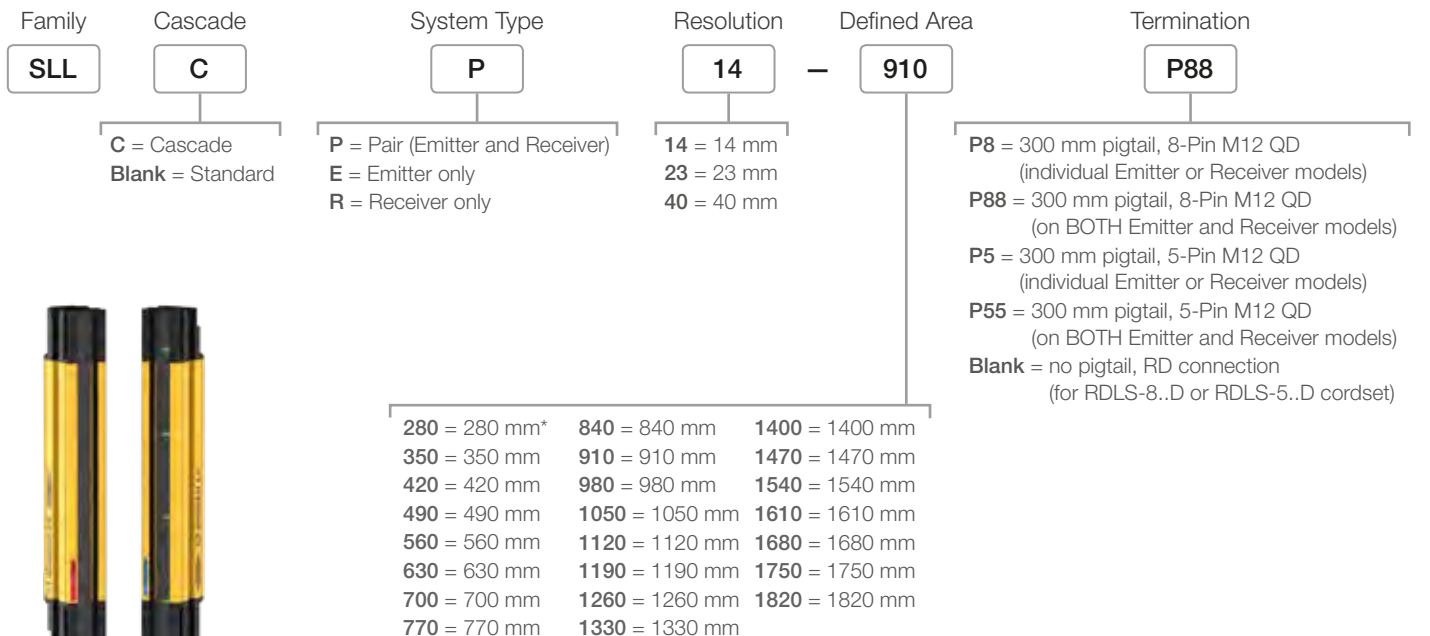

* Not available in cascade models

Safety Light Curtains – Model Keys

Heavy-Duty Type 4 IP69 Hygienic: EZ-SCREEN LS

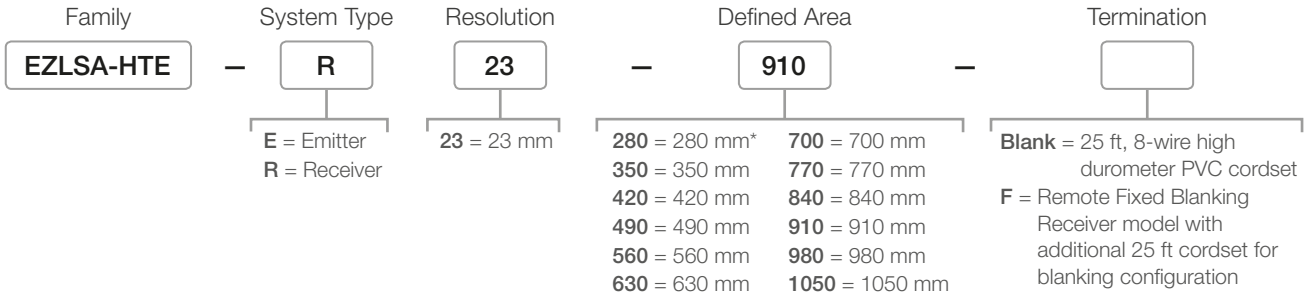

* Not available with remote fixed blanking option

Heavy-Duty Type 4: EZ-SCREEN



* Not available in cascade models
** Only available in cascade models

Type 2: EZ-SCREEN LS2

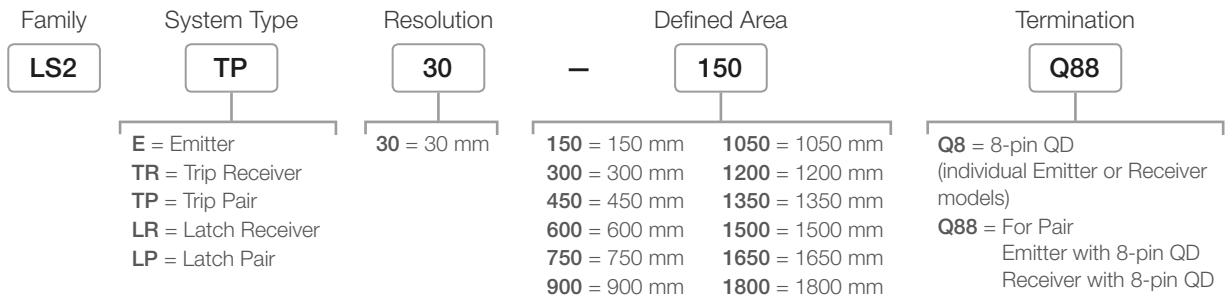

Safety Light Curtains – Accessories

SLC4 Brackets



SLC4A-MBK-10

- End Mount Bracket
- Rotation: +/- 20°
- Includes 4 brackets and hardware
- Glass-filled polycarbonate



SLC4A-MBK-11

- End Mount Bracket
- Rotation: Fixed
- Includes 4 brackets and hardware
- Glass-filled polycarbonate



SLC4A-MBK-12

- Side mount bracket
- Rotation: +/- 15°
- Includes 2 brackets
- Glass-filled polycarbonate



LPA-MBK-21

- Pivoting cascade mounting bracket
- Includes 2 brackets and hardware
- 14 ga. steel, black zinc-plated

LP Brackets



LPA-MBK-10

- End mount bracket
- Rotation: 40°
- Includes 2 brackets and hardware
- 8 ga. steel, black zinc-plated



LPA-MBK-11

- Standard end mount bracket
- Rotation: 360°
- Includes 2 brackets and hardware
- 14 ga. steel, black zinc-plated



LPA-MBK-12

- Standard side mount bracket
- Rotation: +10° and -30°
- Includes 1 bracket and hardware
- 14 ga. steel, black zinc-plated



LPA-MBK-16

- Side mount bracket
- Rotation: +15° and -20°
- Includes 1 bracket and hardware
- Black zinc die-cast



EZLSA-MBK-11

- End mount steel bracket
- 360° rotation in 23° increments
- Two supplied with each sensor
- Not included with LS Basic or IP69 Hygienic models

LS Brackets



EZLSA-MBK-12

- Center mount steel bracket
- Rotation: +/- 15°
- One supplied with each sensor ≥ 980 mm
- Not included with LS Basic or IP69 Hygienic models



EZLSA-MBK-16

- Side mount die-cast bracket
- Rotation: +15° and -20°
- One bracket per optional kit



EZLSA-MBK-20

- 8-ga. black cold-rolled steel
- Optional end-mount bracket for slotted aluminum framing



EZLSA-MBK-HTE-1

- Stamped stainless steel bracket
- 360° rotation for IP69 enclosure models
- Two brackets per optional kit



EZLSA-MBK-HTE-2

- Hygienic stainless steel bracket
- 360° rotation for IP69 enclosure models
- Two brackets per optional kit

Safety Light Curtain Cables

5-Pin M12/Euro-Style

QDE-515D
4.5 m (15')

QDE-525D
7.6 m (25')

QDE-550D
15.2 m (50')

QDE-575D
22.8 m (75')

QDE-5100D
30.4 m (100')



8-Pin M12/Euro-Style

QDE-815D
4.5 m (15')

QDE-825D
7.6 m (25')

QDE-850D
15.2 m (50')

QDE-875D
22.8 m (75')

QDE-8100D
30.4 m (100')

Type 4 Safety Light Grids

Easy-to-use, heavy-duty Type 4 grids for perimeter guarding

Two to four beam Type 4 safety light grids protect personnel from injury and machines from damage by guarding access, areas, and perimeters. Able to detect a body in a cost-effective and heavy-duty safety light curtain package.

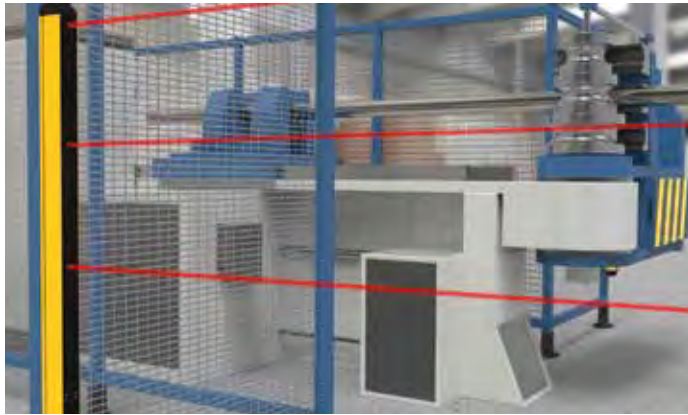

SGS Safety Grid Systems, with two, three, or four beams, are used to monitor the perimeter of the work area.



SGS Safety Grid Systems are available in Emitter/Receiver models capable of safeguarding over very long distances and in easy-to-deploy Active/Passive models.

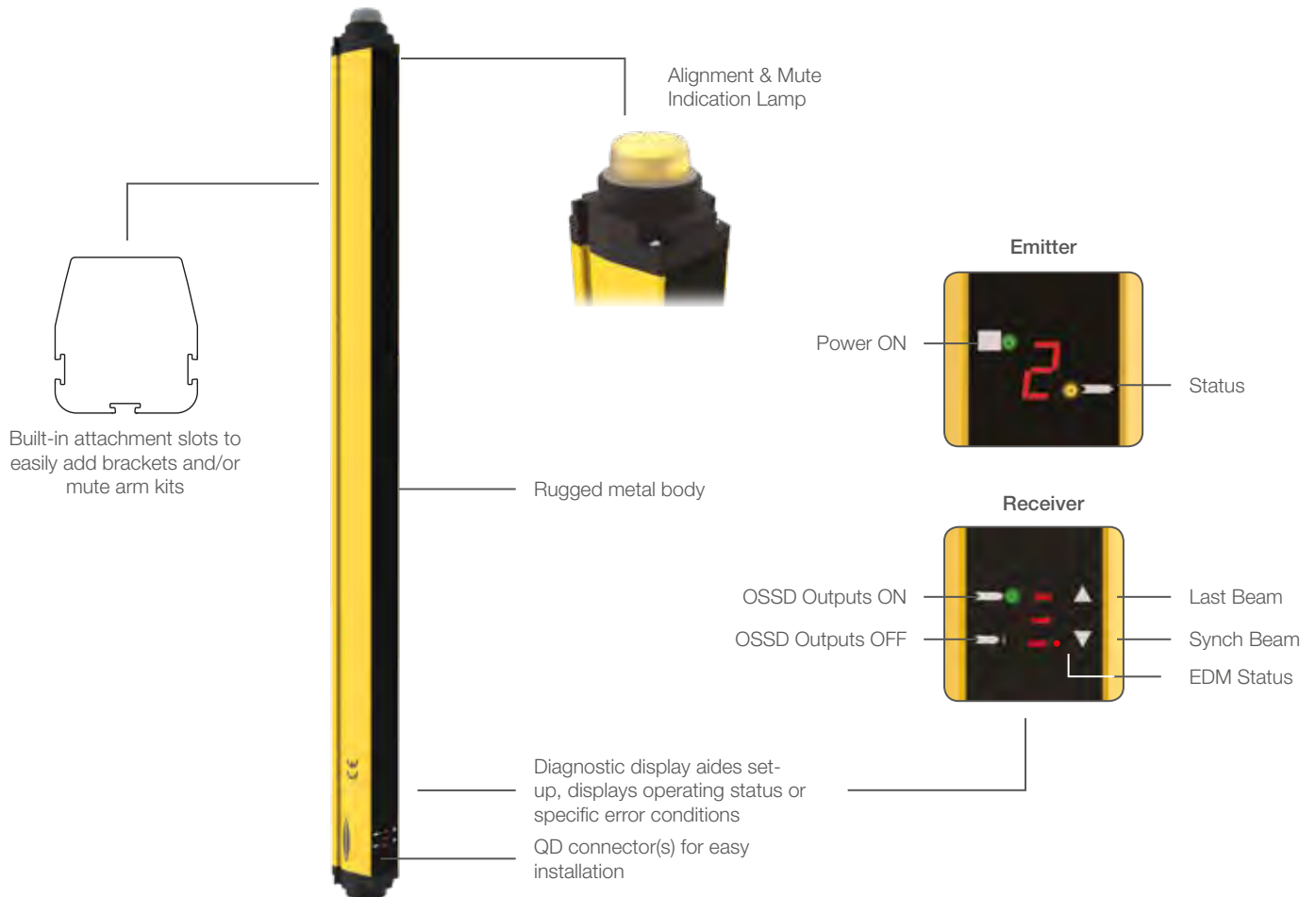

Muting Options for Safety Light Grids

Certain SGS models are available with integral muting for specific types of entry/exit applications

Integral Muting allows monitoring of redundant mute device inputs and automatically suspends (mutes) the safeguarding function of a device during the non-hazardous portion of the machine cycle.



Integral muting models have muting technology built into the device eliminating the need for an external muting controller. Preassembled muting arm kits are available in T, L and X configurations. The muting kits use premounted hardware and Q20 retroreflective sensors and reflectors.

Benefits of Muting

- Maintain high safety standards while allowing for a predetermined object to break a beam
- Limit downtime by not unnecessarily shutting down a conveyor or robot cell

Applications

- Assembly and packaging machines
- Automated production equipment
- Robotic work cells
- Automated warehouses
- Palletizers

Mute Arm Kits

Preassembled (with mounting hardware) for plug-and-play connection to the SGS grid and LS Safety Light Curtains

- Wiring connection block or cable accessories available
- Adjusts easily for line changes

L-Configuration

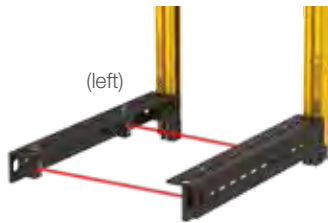

(left)

SGSA-ML-L-LPQ20

- Includes 2 mute arms, 2 SGSA-Q20PLPQ5 mute sensors, and 2 retroreflectors

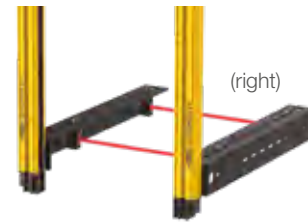

(right)

SGSA-ML-R-LPQ20

- Includes 2 mute arms, 2 SGSA-Q20PLPQ5 mute sensors, and 2 retroreflectors

T-Configuration



SGSA-MT-LPQ20

- Includes 4 mute arms, 4 SGSA-Q20PLPQ5 mute sensors, and 4 retroreflectors

X-Configuration

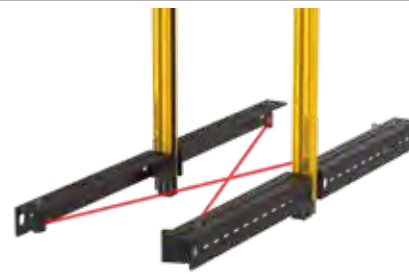

SGSA-MX-LPQ20

- Includes 4 mute arms, 2 SGSA-Q20PLPQ5 mute sensors, and 2 retroreflectors

SGS Selection







Choose your safety light grids for perimeter guarding.

- 2, 3 & 4 beam Emitter/Receiver models with a broad feature set
- 2, 3 & 4 beam easy-to-deploy Active/Passive models, only require wiring to the active side



Body Detection	
Muting	
Family	
Type	IEC 61496-1, -2
Safety Rating	EN ISO 13849-1; IEC 61508; IEC 62061
Dimensions W x D (mm)	
Unit Type	
Max Sensing Range (m)	
Number of Beams	
Beam Spacing	
Reset	
EDM	
Scan Code	
Integrated Muting	
Integrated Muting Lamp	
Override Input	
Connection	
Brackets	
Muting Arms	

Perimeter Guarding Type 4

SGS Active/Passive Use with SGSB	SGS Emitter/ Receiver	SGS Long Distance	SGS Active/Passive with Muting Use with SGSB	SGS Emitter/ Receiver with Muting	SGS Mirror Use with SGSSA/SGSMA
					
SGSSA	SGSSP	SGSXP	SGSMA	SGSMP	SGSB
Type 4	Type 4	Type 4	Type 4	Type 4	/
Category 4 PL e; SIL3; SIL CL3	Category 4 PL e; SIL3; SIL CL3	Category 4 PL e; SIL3; SIL CL3	Category 4 PL e; SIL3; SIL CL3	Category 4 PL e; SIL3; SIL CL3	/
52 x 56.9	52 x 56.9	52 x 56.9	52 x 56.9	52 x 56.9	52 x 56.9
Active/Passive	Emitter/Receiver	Emitter/Receiver	Active/Passive	Emitter/Receiver	Mirror Assembly
0.5 to 8 m (6.5 m ³)	0.5 to 30 m	6 to 60 m	0.5 to 8 m (6.5 m ³)	0.5 to 30 m	/
2/3/4	2/3/4	2/3/4	2/3/4	2/3/4	2/3/4
300 ⁺ /400/500 mm	300/400/500 mm	300/400/500 mm	300 ⁺ /400/500 mm	300/400/500 mm	300/400/500 mm
Functions					
✓	✓	✓	✓	✓	/
✓	✓	✓	✓	✓	/
–	✓	✓	–	✓	/
–	–	–	✓	✓	/
–	–	–	✓	✓	/
–	–	–	✓	✓	/
8-pin M12	8-pin M12	8-pin M12	12-pin M12 and 5-pin M12 for muting sensors	E: 8-pin M12 R: 12-pin M12 E & R: 5-pin M12 for muting sensors	/
Options					
✓	✓	✓	✓	✓	✓
–	–	–	✓	✓	✓

Safety Light Grids – Model Keys

SGS Emitter/Receiver

- When compared to higher resolution light screens, a lower cost option for body detection applications
- Available with integral muting
- Long range, up to 60 m

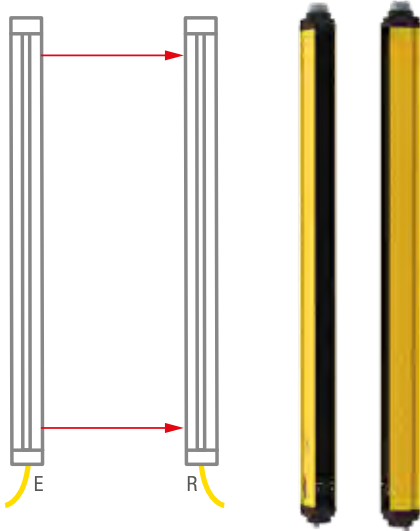

Type	Protective Height (mm)	Range (m)	Integral Muting	Model
Emitter & Receiver	500 (2 beams)	6 to 60	No	SGSXP2-500Q88
	800 (3 beams)			SGSXP3-400Q88
	900 (4 beams)			SGSXP4-300Q88
	1200 (4 beams)			SGSXP4-400Q88
Emitter & Receiver	500 (2 beams)	0.5 to 30	No	SGSSP2-500Q88
	800 (3 beams)			SGSSP3-400Q88
	900 (4 beams)			SGSSP4-300Q88
	1200 (4 beams)			SGSSP4-400Q88
Emitter & Receiver	500 (2 beams)	0.5 to 30	Yes	SGSMP2-500Q128
	800 (3 beams)			SGSMP3-400Q128
	900 (4 beams)			SGSMP4-300Q128
	1200 (4 beams)			SGSMP4-400Q128

SGS Active/Passive

- Active transceiver contains emitter and receiver
- Reduces overall wiring costs
- Available with integral muting
- Up to 8 m range

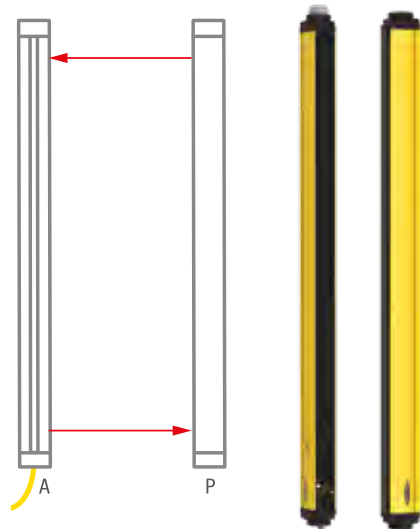

Type	Protective Height (mm)	Range (m)	Integral Muting	Model
Active Transceiver	500 (2 beams)	0.5 to 8	No	SGSSA2-500Q8
	800 (3 beams)	0.5 to 8		SGSSA3-400Q8
	900 (4 beams)	0.5 to 6.5		SGSSA4-300Q8
	1200 (4 beams)	0.5 to 8		SGSSA4-400Q8
Active Transceiver	500 (2 beams)	0.5 to 8	Yes	SGSMA2-500Q12
	800 (3 beams)	0.5 to 8		SGSMA3-400Q12
	900 (4 beams)	0.5 to 6.5		SGSMA4-300Q12
	1200 (4 beams)	0.5 to 8		SGSMA4-400Q12

Passive Mirror



Type	Protective Height (mm)	Range (m)	Model
Passive Mirror Assembly	500 (2 beams)	Pair with Active Transceivers with matching beams and protective heights	SGSB2-500
	800 (3 beams)		SGSB3-400
	900 (4 beams)		SGSB4-300
	1200 (4 beams)		SGSB4-400

Safety Light Grids – Accessories

Connection Options

8-Pin M12/Euro-Style			12-Pin M12/Euro-Style	
QDEG-815D 4.5 m (15')	QDEG-875D 22.8 m (75')		QDEG-1215E 4.5 m (15')	QDEG-1275E 22.8 m (75')
QDEG-825D 7.6 m (25')	QDEG-8100D 30.4 m (100')	QDEG-1225E 7.6 m (25')	QDEG-12100E 30.4 m (100')	
QDEG-850D 15.2 m (50')		QDEG-1250E 15.2 m (50')		

Mute Connection Options

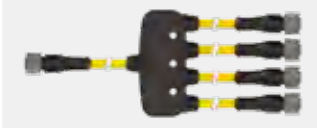
Model	Description	
SGSA-MCB	Connection box for X, L or T mute arm kits	
SGSA-MCS-2	Connection cable for X and L mute arm kits	
SGSA-MCS-4	Connection cable for T mute arm kits	
SGSA-MCB-HW	Optional hardware kit for mounting mute connection box, or mute connection cable to the t-slot of SGS Receiver or Active Unit	

Bracket



SGSA-MBK-10-4
■ End-mount bracket

Stands and Corner Mirrors



SGSA-S Series Enclosures

Enclosure Model	Fits SGS Models	# of Windows	Enclosure Height	Distance from Floor to Bottom Window	Distance between Beams
SGSA4-S300	SGS..4-300Q..	4	1543 mm (60.75")	300 mm (11.8")	300 mm (11.8")
SGSA4-S300-M					
SGSA3-S400	SGS..3-400Q..	3	1238 mm (48.78")	300 mm (11.8")	400 mm (15.8")
SGSA3-S400-M					
SGSA4-S400	SGS..4-400Q..	4	1618 mm (63.69")	300 mm (11.8")	400 mm (15.8")
SGSA4-S400-M					
SGSA2-S500	SGS..2-500Q..	2	1035 mm (40.75")	400 mm (15.8")	500 mm (19.7")
SGSA2-S500-M					



SSM Series Corner Mirrors

Mirror Model	Fits SGS Models	Reflective Area	Mounting Area	Mirror Height
SSM-550	SGS..2-500..	550 mm (21.7")	661 mm (26.0")	628 mm (24.7")
SSM-825	SGS..3-400..	825 mm (32.5")	936 mm (36.9")	903 mm (35.6")
SSM-975	SGS..4-300..	975 mm (38.4")	1086 mm (42.8")	1053 mm (41.5")
SSM-1275	SGS..4-400..	1275 mm (50.2")	1386 mm (54.6")	1353 mm (53.3")



MSA Series Stands

Stand Model	Pole Height	Usable Stand Height
MSA-S66-1	1676 mm (66")	1550 mm (61")
MSA-A84-1	2134 mm (84")	2007 mm (79")
MSA-S105-1	2667 mm (105")	2667 mm (100")

Safety Scanner System

Horizontal or vertical monitoring of both personnel and stationary or mobile systems

SX Series safety laser scanners protect personnel, equipment, and mobile systems by continuously scanning a user-defined area of up to 275° to create a two-dimensional protected zone.



SX5 software configuration allows for Zone switching for FULL, RIGHT-SIDE and LEFT-SIDE Safety Protection during this forklift access application.



Software interface makes it easy to create custom safety and warning zones to safeguard large, complex, and irregularly shaped areas.

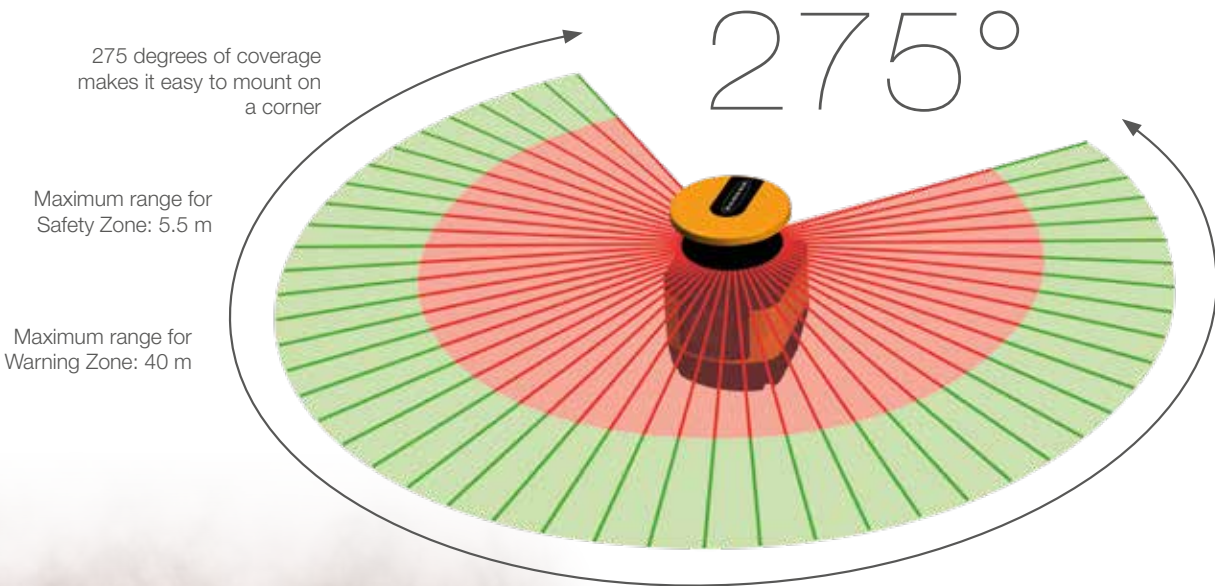

Light Immune and dust resistant – Best-in-class

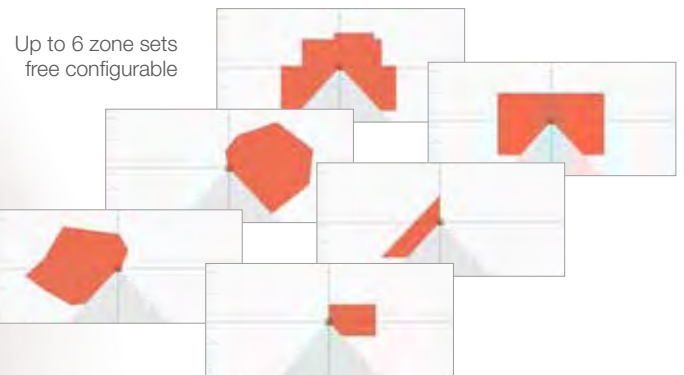

Safety Scanner System

Increased machine uptime

The SX5-B has on-board LED indicators and a large multi-segment color display that provide at-a-glance system status information so users can quickly identify zone breaches and resolve issues with a minimal amount of equipment downtime.

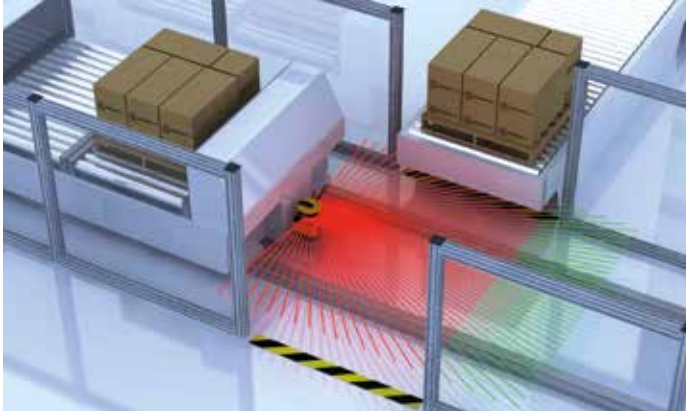

Compact, one-piece safety device installs easily above and away from area hazards without requiring time-consuming alterations to area infrastructure.

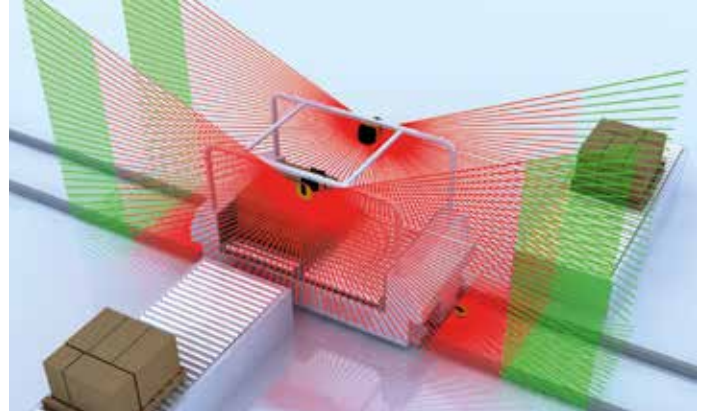

An alert is triggered if an object enters the warning zone and equipment will come to a stop if the safety zone is breached.



27 different status, diagnostic, warning and error displays

Dynamic Muting available and selectable detection capability for vertical applications

Rugged design for reliable industrial use



- LED 1: Object Detection in Safety Zone (OSSD)
- LED 2: Not Available
- LED 3: Assigned to Warning Zone 2
- LED 4: Assigned to Warning Zone 1
- LED 5: Interlock Status (waiting for Reset)



M12 Ethernet connector cover

Keypad

Safety Scanner System – Software

Simple setup for rapid deployment

The SX5-B can be set up in just a few simple steps using Banner's free configuration software. This robust software features menu-driven tools that guide users through setup and make it easy to design custom safety and warning zones to accommodate existing infrastructure and meet the specific needs of any application.

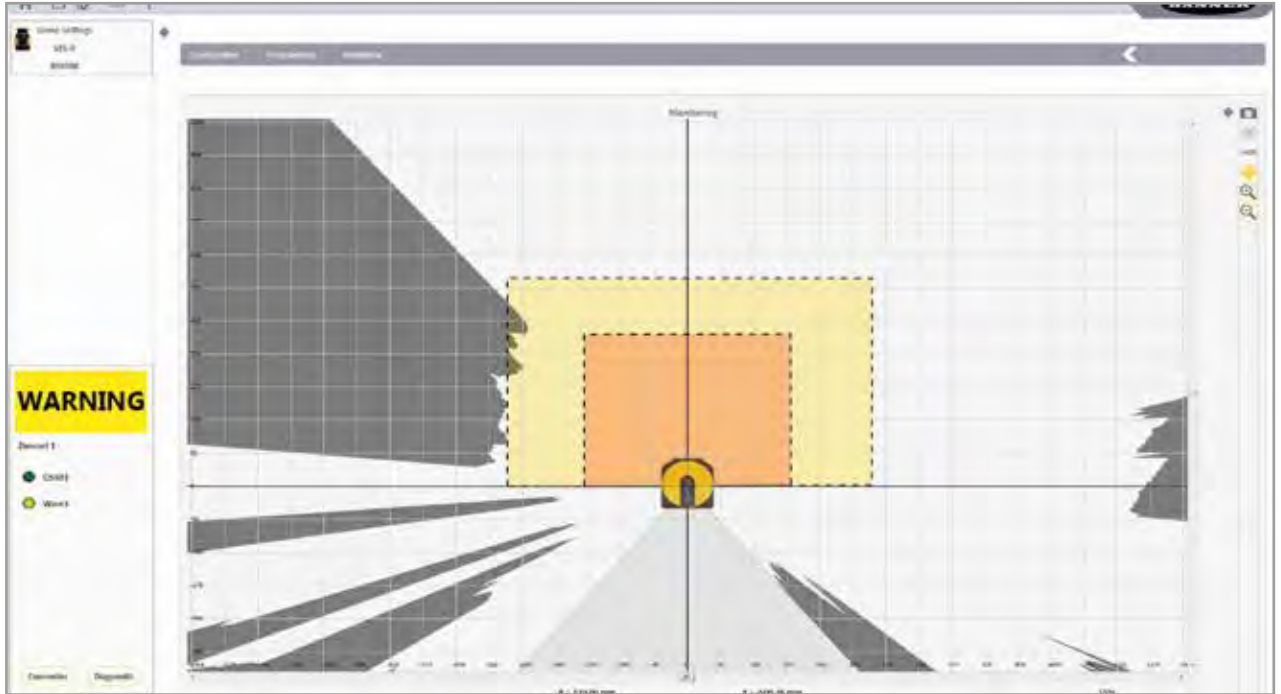

The software displays a graphic rendering of the monitored area, and provides configuration and management tools, such as drop-down menus, function-specific worksheets...

- Administrative data: file title header, application description and more
- Safety-relevant data: startup process information
- Safety Zone or Warning Zone configuration data: contours and limits



Safety Scanner System – Models and Accessories

SX Series Safety Scanners



Model	Protective Field Range	Warning Field Range	Scanning Angle	Dimensions H x W x D (mm)	Features
SX5-B	0.05 m to 5.5 m	40 m	275°	152 x 112.5 x 102	LCD Display, Muting

SX Series Safety Scanners Specifications

Detection Capability	40 mm, 70 mm	Current Consumption (24V dc)	No output load: 0.3A at 24V dc With maximum output load: 1.1A at 24V dc
OSSD (Safety Outputs)	2 OSSD All inputs and outputs are protected from short circuits to +24V dc or dc common	Mechanical Data	Housing material: Aluminum Alloy Housing color: Yellow RAL1003 Optics cover material: PC Optics cover surface: Acrylic
Zone Sets	Six	Safety Data	Type 3 (EN 61496-1) SIL 2 (IEC 61508) Category 3 (EN ISO 13849-1) SIL CL 2 (EN 62061) PL d (EN ISO 13849-1)
Environmental Rating	IEC IP65	Optical Data	Wavelength: 905 nm Pulse duration: 3 nsec Laser class: CLASS 1 (EN 60825-1)
Operating Conditions	0° C to +50° C (+32° F to +122° F) 95% maximum relative humidity (non-condensing)	Certifications	 

SX Series Safety Scanners Brackets



SXA-MBK-1

- Pitch and roll angle adjustment bracket
- Bracket memory feature allows for fast scanner swap out



SXA-MBK-2

- Protection bracket



SX Series Safety Scanners Cables

8-Pin M12/Euro-Style Straight connector

SXA-815D 4.5 m (15')	SXA-850D 15.2 m (50')
SXA-825D 7.6 m (25')	SXA-8100D 30.4 m (100')



4-Pin M12 D-Code to RJ45 Double ended

STP-M12D-406 1.83 m (6')	STP-M12D-430 9.14 m (30')
STP-M12D-415 4.5 m (15')	



Safety Relays and Safety Controllers

Configurable controllers monitor multiple safety devices

Industrial safety controllers and relays provide an interface between safety devices and the machines and processes those devices monitor for a complete and easy-to-use safety control solution.

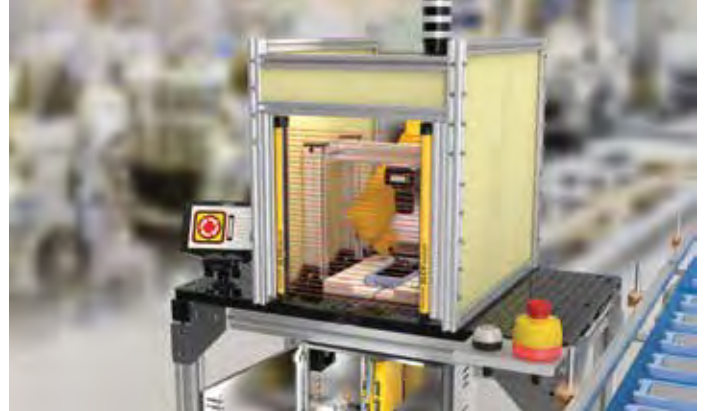

Safety controllers can be tailored for a wide variety of machines, including machines with multiple processes.

Safety Relays



Cost-effective for simple safety circuits

- Preset Functionality: Configuration not required
- Safety Inputs: 1
- Independently controlled Safety Outputs: 1; 4 to 7A

Hybrid Safety Controller plus 2 Safety Relays



Flexible and cost-effective solution for machines typically using 2 Safety Relays

- PC Configurable: Flexible and easy-to-use
- Safety Inputs: up to 10; up to 14 using Automatic Terminal Optimization (ATO)
- Independently controlled Safety Outputs: 2; 6A each
- Convertible Safety Inputs: 4
- Terminal LEDs for easy troubleshooting
- Industrial Ethernet

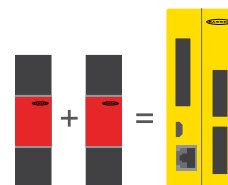

Safety Relays and Safety Controllers

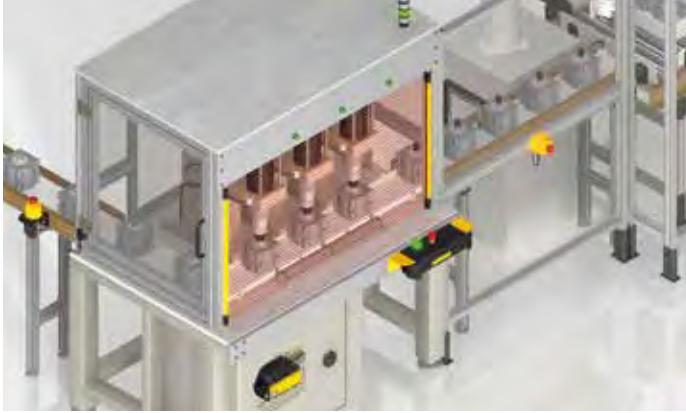

Various safety devices are monitored, such as E-stop buttons, safety switches, safety light screens, two-hand controls and rope pull switches.

Connect safety devices easily to the safety controller

- Universal input safety relays
- E-Stop monitoring safety relays
- Muting safety relays
- Safe speed monitoring relays
- Safety mat relays
- Safety extension relays



Expandable Safety Controller



XS26

Expandable for complex safety applications where 3 or more safety relays are typically used

- PC Configurable: Flexible and easy-to-use
- Safety Inputs: 26 (base unit) up to 154
- Independently controlled Safety Outputs: up to 68; 0.5A to 6A each
- Convertible Safety Inputs: 8 (Base Unit) up to 40
- LCD Display for easy troubleshooting
- Industrial Ethernet

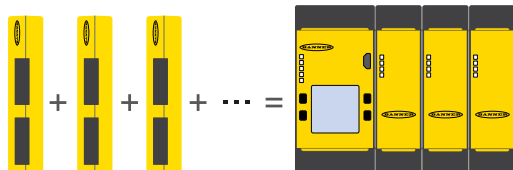

E-Stop Light Curtain Safety Mat 2-Hand Control Rope Pull

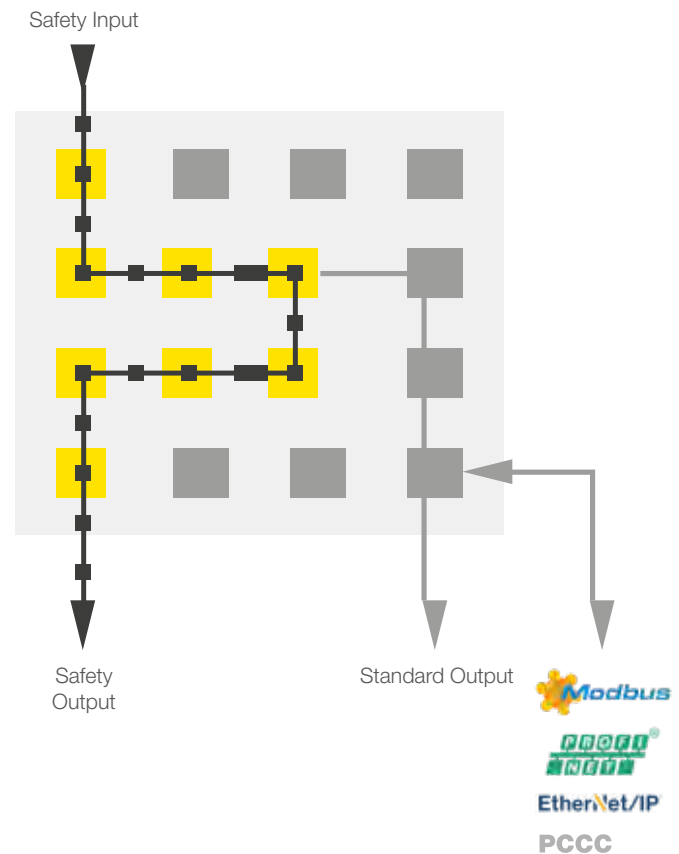

Build System and Select Equipment

The feature-rich SC10 and SC/XS26 safety controller software provides a seamless user interface for setting up and managing safety systems. The software features an intuitive icon-based, drag-and-drop user interface to reduce the learning curve and speed up commissioning.

- Complex configurations made easy
- Simulate configurations before implementation
- Auto configure Industrial Ethernet for remote monitoring and diagnostics

Start using the free software today. Go to www.bannerengineering.com/safetycontroller

1. Choose Controller



2. Equipment View

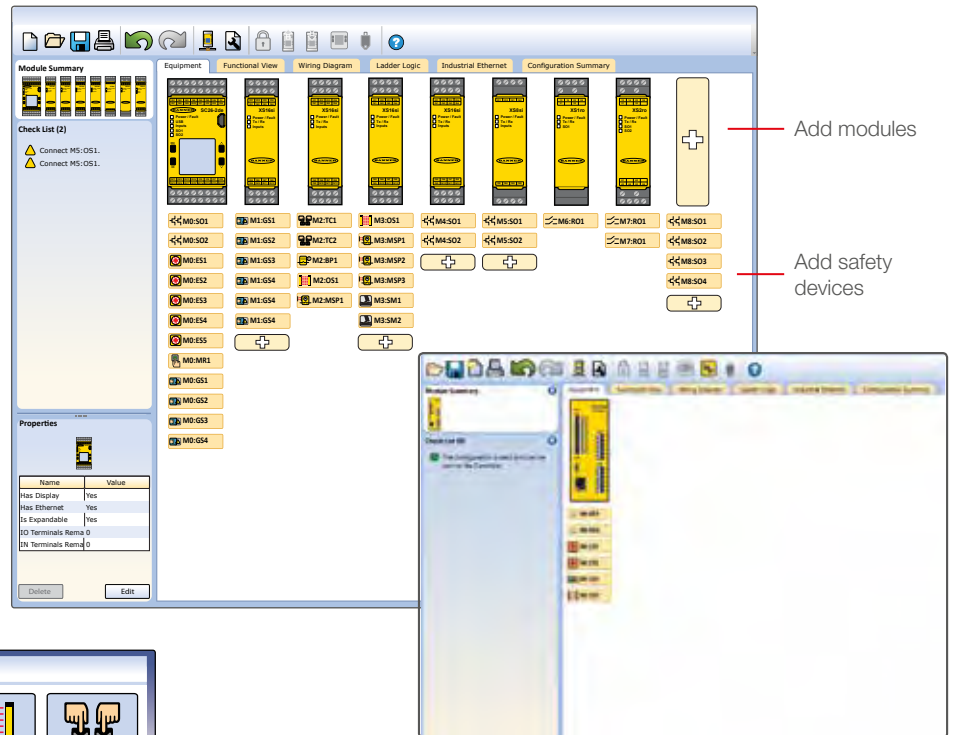

3. Add safety devices

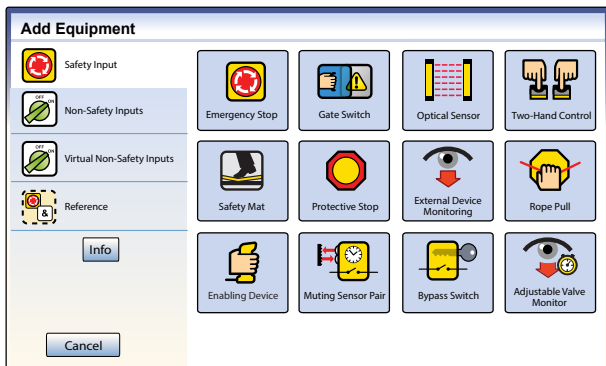

4. Select safety device properties

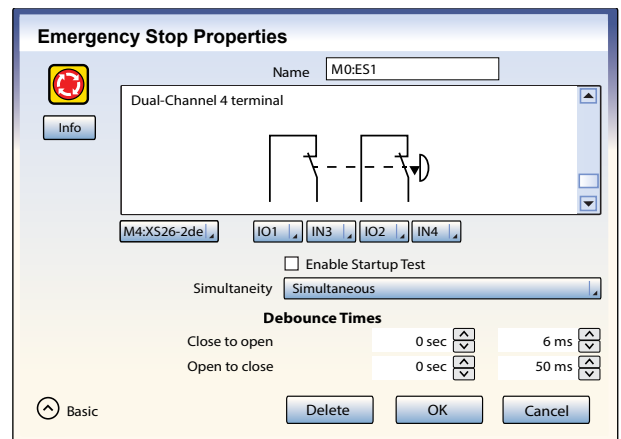

5. Add virtual non-safety inputs

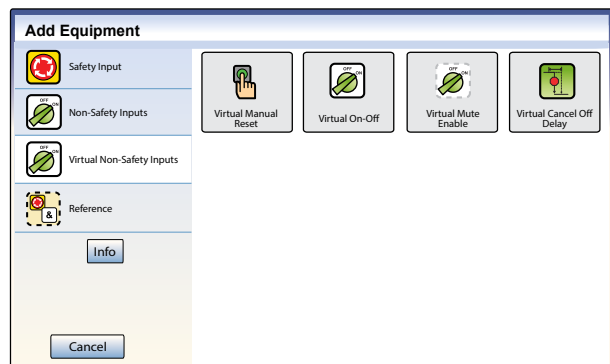

Configure your system in minutes

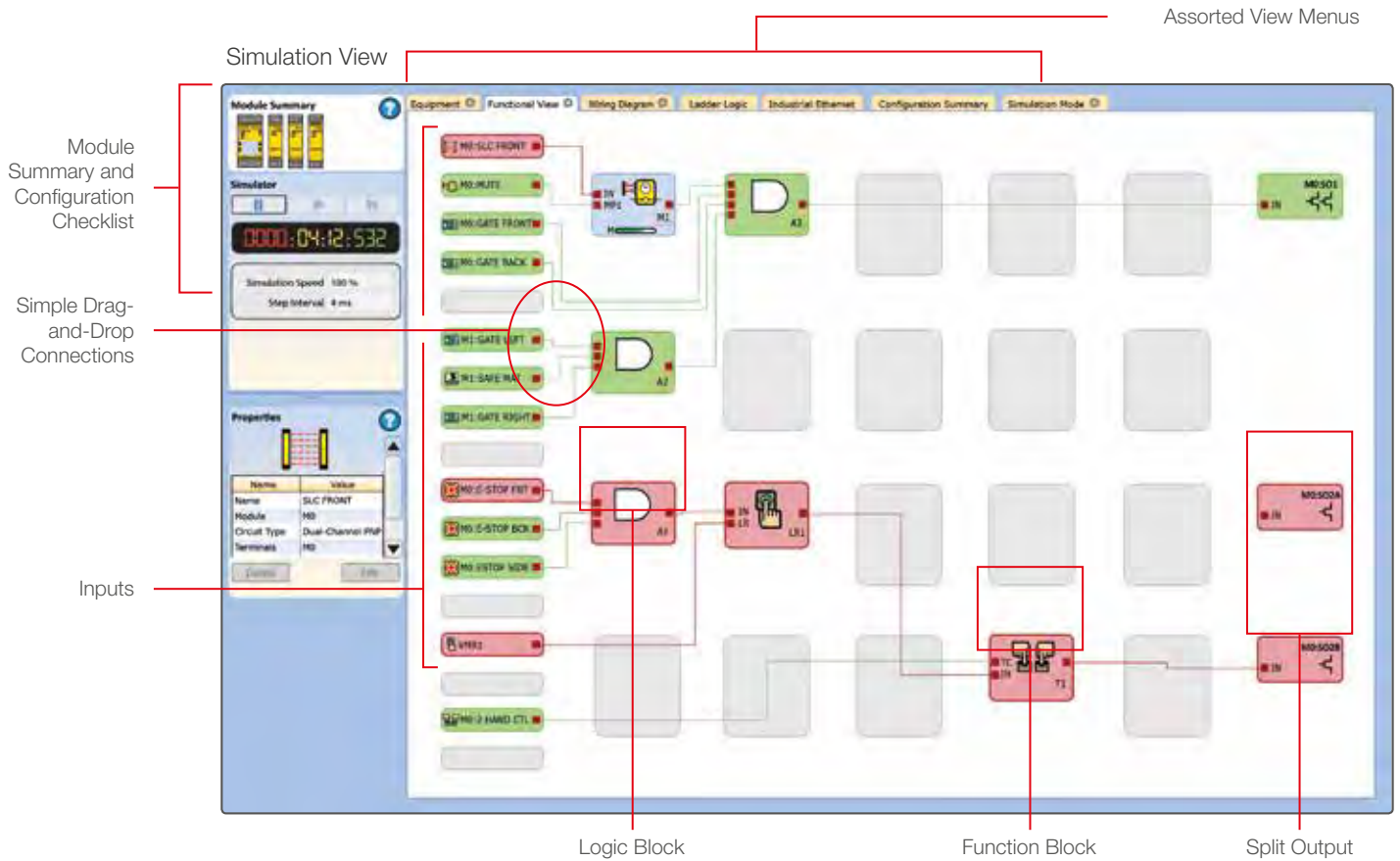

Wiring Diagram

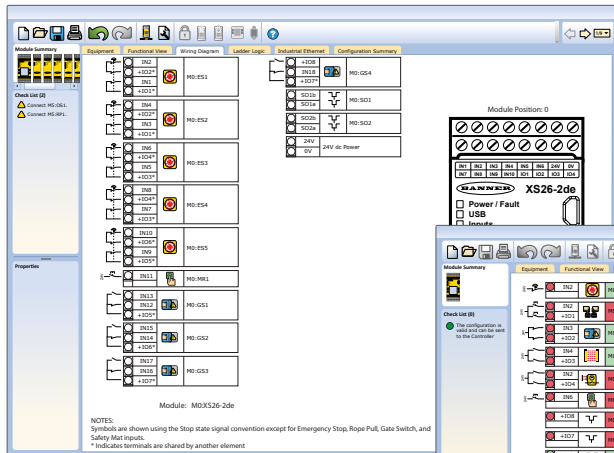

Wiring Diagram in Live Mode

Ladder Logic

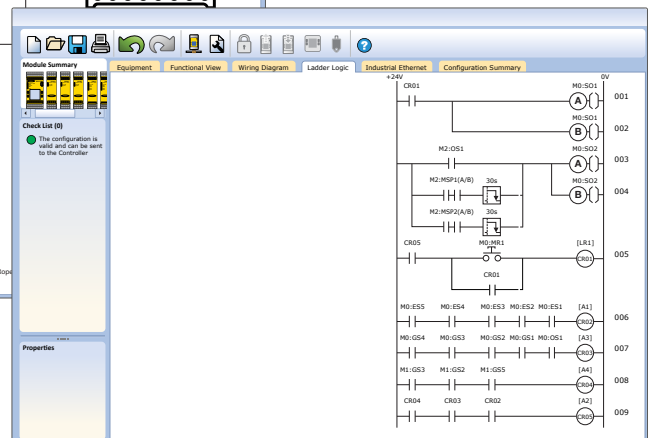

Safety Controllers

XS26 Expandable Safety Controller

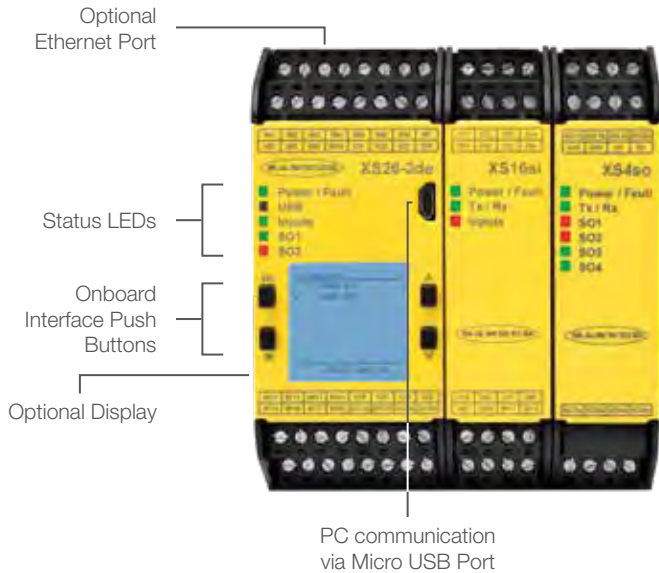

- Optional display screen allows local diagnostics for efficient troubleshooting
- Up to eight expansion I/O modules can be added as automation requirements grow or change
- Choose from six expansion module models with a variety of safety inputs, solid-state safety outputs and safety relay outputs
- Controller and input modules allow safety inputs to be converted to status outputs for efficient terminal use

SC10 Safety Controller with SC-XM3 Programming

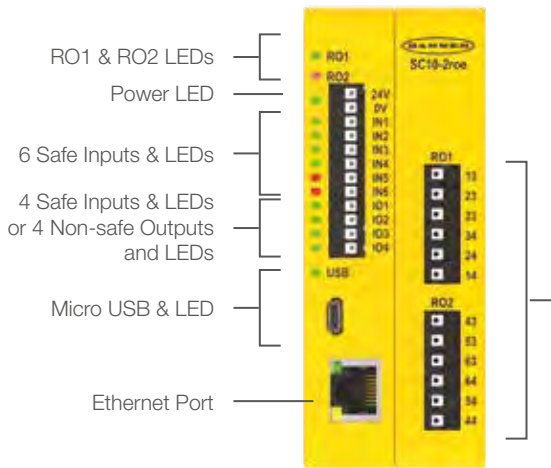

- 2x 6A independently controlled relays (RO1 and RO2)
- 3 NO sets of contacts each

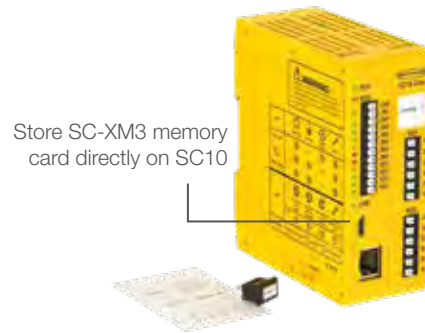

SC-XM3 Fast Programming and Swapout

- Backup copy of configuration, password, network settings
- Download configuration without a PC; save time during panel build
- Fast swapout to minimize downtime at swapout



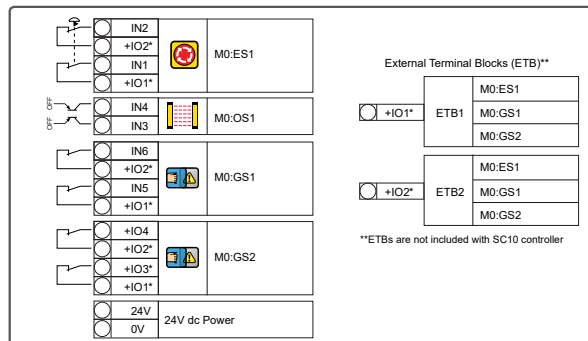
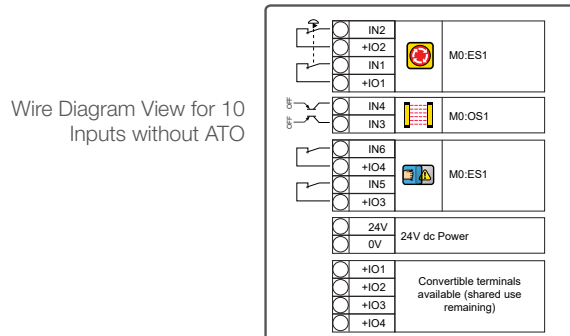

Automatic Terminal Optimization (ATO)

- Allows for an increase from 10 to 14 inputs





Safety Controllers – Models

XS26 Safety Controllers

Model (24V dc)	Description	Housing H x W x D (mm)	Inputs/Convertible	Independently Controlled Safe Outputs	Maximum Safety Output Rating
 XS26-2d XS26-2de	Base Controller, expandable, with LCD	110 x 45 x 128	26/8	2 Dual Channel PNP	0.5A @ 24V dc
 XS26-2 XS26-2e	Base Controller, expandable	110 x 45 x 128	26/8	2 Dual Channel PNP	0.5A @ 24V dc
 XS8si	Safety Input Module	W: 22.5 mm	8/2	/	/
 XS16si	Safety Input Module	W: 22.5 mm	16/4	/	/
 XS2so	Safety Output Module	W: 22.5 mm	/	2 Dual Channel PNP	0.75A @ 24V dc
 XS4so	Safety Output Module	W: 22.5 mm	/	4 Dual Channel PNP	0.5A @ 24V dc
 XS1ro	Safety Relay Output Module	W: 22.5 mm	/	1 Dual Channel Relay	6A; 2 NO, 1 NC Aux
 XS2ro	Safety Relay Output Module	W: 22.5 mm	/	2 Dual Channel Relays	6A; 2x 2 NO, 2x 1 NC Aux

SC26 Safety Controllers

Model (24V dc)	Description	Housing H x W x D (mm)	Inputs/Convertible	Independently Controlled Safe Outputs	Maximum Safety Output Rating
 SC26-2d SC26-2de	Base Controller, non-expandable, with LCD	110 x 45 x 128	26/8	2 Dual Channel PNP	0.5A @ 24V dc
 SC26-2 SC26-2e	Base Controller, non-expandable	110 x 45 x 128	26/8	2 Dual Channel PNP	0.5A @ 24V dc

SC10 Safety Controllers

Model (24V dc)	Description	Housing H x W x D (mm)	Inputs/Convertible	Independently Controlled Safe Outputs	Maximum Safety Output Rating
 SC10-2roe	Base Controller	115 x 45 x 100	10/4	2 Dual Channel Relays	2x 3 NO: 6A 250V ac/24V dc

Accessories

			
SC-USB2 ■ USB Cable	SC-XM2 ■ Memory Card for XS26 and SC26	SC-XM3 ■ Memory Card for SC10	SC-XMP2 ■ SC-XM2/3 Configuration Tool

Relay and Controller Selection

Choose a safety relay or safety controller.

- Configurable (expandable) safety controllers
- Preconfigured safety relay modules



GM/ES

UM



Self Testing Safety Device			✓	
Self Testing Safety Device with EDM Function			✓	
E-Stop		✓	✓	
Rope Pull		✓	✓	
Gate Switch		✓	✓	
RFID Gate Switch			✓	
Safety Mat Monitoring				
Two-Hand Control				
Enabling Device		✓	✓	
Extension Contacts				
Speed Monitoring				
Muting				
ON/OFF Delay				
Safety Standard				
Inputs		1 NC & 1 NO (single or dual) 1 NC (single) 2 NC (dual)	1 NC (single) or 2 NC (dual) or 2 PNP	
Safety Outputs		2 NO / 3 NO / 4 NO	3 NO or 2 NO	
Maximum Safety Output Rating		6A / 7A	7A	
Auxiliary Outputs		1 NC or 1 NC & 2 PNP	1 NC, depending on model	
Power Supply		24V ac/dc 115V ac & 12-24V dc or 230V ac & 12-24V dc	24V ac/dc	

Preconfigured Safety Relay Modules							Configurable Controllers		
SM	AT	MMD	SSM	SR	IM	EM	SC10	SC26/XS26	
									
		✓					✓	✓	
		✓		✓	✓		✓	✓	
		✓ (secondary function)					✓	✓	
		✓ (secondary function)					✓	✓	
		✓					✓	✓	
		✓					✓	✓	
✓							✓	✓	
	✓						✓	✓	
							✓	✓	
						✓		✓	
			✓						
		✓					✓	✓	
						OFF Delay available	✓	✓	
Cat. 4 PL e, per EN ISO 13849-1; SIL 3 per IEC 61508 and IEC 62061									
1 (or multiple in series) 4-wire safety mat	2 STB or buttons with complementary contacts	2 NC muteable (dual) & 2 NC SSI (dual)	2 PNP	2 NC (dual) or 2 PNP	2 NC (dual) or 2 PNP	1 NC (single) or 2 NC (dual)	10	SC26: up to 26 XS26: up to 154	
4 NO	2 NO	2 PNP OSSD or 2 NO	2 NO	2 NO / 3 NO	2 NO / 3 NO	4 NO or 4 NO with delay	2x 3 NO	SC: 2 XS: up to 68	
6A	6A	6A	4A	6A	6A	6A	6A each	0.5A each	
1 NC & 2 PNP	/	1 PNP or 1 NC	1 NC	1 NC	1 NC, depending on model	/	depending on configuration	depending on configuration	
115V ac & 12-24V dc or 230V ac & 12-24V dc	24V ac/dc	24V dc	24V dc	24V dc	24V dc	24V dc or 24V ac/dc, depending on model	24V dc	24V dc	

Safety Switches



Hinge Switches



Locking Switches



- One-piece sensor and actuator with hinge function
- Fast installation and set-up with repositionable safety switch point
- Stainless steel and IP69 available
- Matching hinges without sensing available for additional door support
- Available with up to 270° safety switch point operation range



- Two-piece design with up to 2000N locking force for safety or process critical applications
- Flexible actuator options for misalignment
- Rotatable heads for flexible installation
- Mechanically coded actuator to minimize tampering
- Up to 15N latching force to position door prior to locking

Mechanical Switches



- Two-piece design with mechanical operator feedback
- Flexible actuator options for misalignment
- Rotatable heads for flexible installation
- Mechanically coded actuator to minimize tampering
- Up to 15N latching force to reduce downtime due to vibrating doors
- One-piece limit switches available

Non-Contact Switches



- Two-piece design where sensor and actuator do not contact
- In-Series Diagnostics (ISD) provides users with data from each sensor in a cascade chain
- Cascade up to 32 sensors while achieving the highest level of safety
- Accommodating to misalignment
- IP69 solutions available
- Available with the highest level of tamper resistance

Non-Contact Safety Switches



RFID SI-RF Switches

Safety switches respond when a mechanical guard is opened. They feature “positive opening” contacts for high reliability regardless of environmental conditions and withstand attempts to override the switch and defeat the system.

RFID SI-RF Switches – Cascade



Single door RFID non-contact gate/door sensing solution

- Basic, medium and high tamper resistance
- Misalignment tolerance of 10 mm
- Resistant to high vibration and operations with metallic shavings
- On-board LED for status and diagnostics



Multiple door RFID non-contact gate/door sensing solution

- Basic, medium and high tamper resistance
- Misalignment tolerance of 10 mm
- Resistant to high vibration and operations with metallic shavings
- On-board LED for status and diagnostics
- Connect up to 32 sensors in cascade while maintaining the the highest level of safety

RFID SI-RF Switches – Cascade and ISD



Multiple door RFID non-contact gate/door sensing solution



In-Series Diagnostics (ISD) provides users with status and performance data from each sensor in a cascade chain. The ISD data collected is converted to IO-Link so it can be accessed with an HMI or similar device. Users receive notification when an event has occurred as well as where in the series the event occurred. Events include the opening or closing of a door, door misalignment, wrong actuator, and a number of switch health attributes.













Safety Switches Selection











Choose a safety switch.

- Magnetic safety switches
- Plastic or metal compact safety switches
- Hinge safety switches
- Guard locking safety switches
- Rotary Lever, Plunger, Roller and Spindle-Mount Safety Limit Switches



Non-Contact Switches	
Magnetic	RFID
SI-MAG	SI-RF
	

Non-Locking		✓	✓
Locking			
Position		✓	✓
Contacts		1 NC/1 NO	OSSD PNP
Locking or Unlocking Power			
Straight Rigid In-Line			
Rigid In-Line			
Flexible In-Line			
High-Force Accessory			
LED Status Indication			✓
Cascadable			✓
ISD (In-Series Diagnostics)			✓
Coding level/ Manipulation protection EN ISO 14119	Low coding	Unique/Low/High coding	
Housing Material	Plastic	Plastic	
Locking			
Actuation Extraction Force			

Switches with Separate Actuator							Hinge Switches			
SI-LS100	SI-LS83	SI-QS90	SI-QS75	SI-LM40	SI-LS42	SI-QM100	Hinge		Rotating Head	
SI-HG63	SI-HG80	SI-LS31								
										
✓	✓	✓	✓	✓			✓	✓	✓	
					✓	✓				
Limit Switch Model Available	Limit Switch Model Available			Limit Switch Model Available					✓	
2 NC/1 NO	1 NC/1 NO 2 NC	1 NC/1 NO 2 NC 2 NC/1 NO	1 NC	1 NC/1 NO 2 NC 2 NC/1 NO	1 NC/1 NO 2 NC/1 NO 1 NC 2 NC 3 NC	1 NC/1 NO 2 NC	2 NC/1 NO	SPDT	1 NC/1 NO 2 NC	
					24V ac/dc 110V ac/ 230V ac	24V dc 120V ac 24V ac				
✓	✓			✓	✓	✓				
✓	✓	✓	✓							
✓	✓	✓	✓	✓	✓	✓				
		✓	✓							
Low coding	Low coding	Low coding	Low coding	Low coding	Low coding	Low coding	Uncoded	Uncoded	Uncoded	
Plastic	Plastic	Plastic	Plastic	Metal	Plastic	Metal	Metal	Metal	Metal	
					Spring lock Solenoid lock	Spring lock Solenoid lock				
10 N	10 N	10 N High-Force models: ad- justable from 50-100 N	10 N High-Force models: ad- justable from 50-100 N	10 N/20 N	2000 N when locked	1000 N when locked			10 N/15 N	

Emergency Stop Buttons



The 30 mm mount illuminated E-stop button has a unique 360 degree round housing, with a red button and yellow background, meeting worldwide safety standards. Models are also available in a non-lit, solid black base for additional safety applications.

Emergency Stop and Stop Controls

Emergency stop devices provide workers a means of stopping a device during an emergency by pushing a button or pulling a rope in order to prevent injury to personnel and material loss.

The red flashing illumination of the E-stop button visibly alerts operators which button was pressed so they can quickly and easily fix the problem to reduce downtime and only reset the button that was activated. When one button is pressed all other buttons turn red.

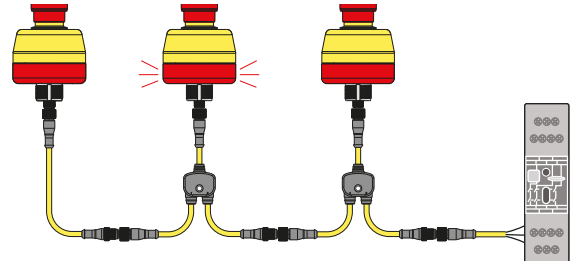

30 mm Mount Electro-Mechanical E-Stop Push Button, IP65 rating

Model	E-Stop Contacts	Illuminated Base	Connection
SSA-EB1P-02ECQ4	2 NC	/	4-pin M12 QD
SSA-EB1P-11ECQ4	1 NO/1 NC	/	4-pin M12 QD
SSA-EB1P-22ECQ8	2 NO/2 NC	/	8-pin M12 QD
SSA-EB1PLYR-12ECQ8	1 NO (PNP)/2 NC	Yellow & Red (Flashing/Solid)	8-pin M12 QD
SSA-EB1PLGR-12ECQ8	1 NO (PNP)/2 NC	Green & Red (Flashing/Solid)	8-pin M12 QD
SSA-EB1PLXR-12ECQ8	1 NO (PNP)/2 NC	OFF & Red (Flashing/Solid)	8-pin M12 QD
SSA-EB1PL-12ECQ8	1 NO (PNP)/2 NC	OFF & Red (Solid/Solid)	8-pin M12 QD

Flat Mount Electro-Mechanical E-Stop Push Button, IP65 rating

Standard Actuator	Lockable Actuator	E-Stop Contacts	Connection
SSA-EB1P-02ED1Q4	SSA-EB1MP-02ED1Q4	2 NC	4-pin M12 QD
SSA-EB1P-11ED1Q4	SSA-EB1MP-11ED1Q4	1 NO/1 NC	4-pin M12 QD
SSA-EB1P-22ED1Q8	SSA-EB1MP-22ED1Q8	2 NO/2 NC	8-pin M12 QD
SSA-EB1PL2-12ED1Q8	SSA-EB1ML2P-12ED1Q8	1 NO/2 NC Illuminated button (Push ON)	8-pin M12 QD

Illuminated-base, with 1 NO (PNP)/2 NC E-Stop Contacts, IP65 rating

Standard Actuator	Lockable Actuator	Illuminated Base	Connection
SSA-EB1PLXR-12ED1Q8	SSA-EB1MLXRP-12ED1Q8	OFF & Red (Flashing/Solid)	8-pin M12 QD
SSA-EB1PLYR-12ED1Q8	SSA-EB1MLYRP-12ED1Q8	Yellow & Red (Flashing/Solid)	8-pin M12 QD
SSA-EB1PL-12ED1Q8	SSA-EB1MLP-12ED1Q8	OFF & Red (Solid/Solid)	8-pin M12 QD
SSA-EB1PLGR-12ED1Q8	SSA-EB1MLGRP-12ED1Q8	Green & Red (Flashing/Solid)	8-pin M12 QD



SSA-EB1P-ECWC
FDA Grade Silicone Washdown Cover
IP67 and IP69 rated

Rope Pull E-Stop Devices and Switches



- Switch activates if the rope is pulled, becomes loose or breaks
- Rugged plastic housing to withstand harsh environments or heavy-duty housing rated to IP67 for use outdoors
- Models available with additional solid-state auxiliary output for remote tension monitoring
- Models available with E-stop button with manual reset
- Tension indicators

Rope pull emergency stop switches, when used with steel wire rope, provide emergency stop actuation for conveyors and large machinery.

Rope Pull E-Stop Devices



Model	Maximum Rope Length	Safety Contacts	Auxiliary Contacts	Actuation	Housing Material
RP-RM83	38 m 75 m	2 NC in	2 NO in	Latch	Metal, IP67
RP-LS42	25 m 37.5 m 75 m	2 NC in	2 NO in	Latch	Plastic

Rope Pull Switches



Model	Maximum Rope Length	Safety Contacts	Auxiliary Contacts	Actuation	Housing Material
RP-QM72	6 m 12 m 20 m	2 NC in	/	Latch	Metal
RP-QMT72	12 m	4 NC in 2 NC in	/ 1 NO in	Latch	Metal
RP-LM40	6 m	2 NC in	/	Trip & Latch	Metal
RP-QM90	100 m (50 m each side)	2 NC in	2 NO in	Latch	Metal

Components for Wire Rope Assembly



RPA-C
■ Wire Ropes



RPA-T
■ Thimbles



RPA-CC
■ Clamps



RPA-TA
■ Turnbuckles



RPA-EB
■ Eye Bolts



RPA-P
■ Pulleys



RPA-S
■ Tensioning Springs

Hardware kits are available (RPAK)

Enabling Devices



A two-hand control safeguarding system will prevent the operator from approaching the machine while a hazard is present. Duo-Touch Run Bar provides an all-in-one solution. Operators can touch the Safety Touch Buttons on either side of the run bar to start or stop a process, or press the E-Stop button to completely halt the assembly line.



Manually operated safety control devices which, when continuously activated and used in conjunction with a separate actuating control, will allow the machine to function in manual operating mode. The handheld grip-styled switch is used for manual control of machine functions, including visual observations, minor adjustments, calibration and more.

Two-Hand Control

STB Self-Checking Touch Buttons



Model	Connection	Touch Surface Material	Output	Power Supply
STBVP6	2 m cable	Polyetherimide (PEI)	Solid-state 2 Complementary PNP (1 ON, 1 OFF)	10-30V dc
STBVP6Q5	4-pin M12 QD			
STBVR81	2 m cable	Polyetherimide (PEI)	E/M Relay 2 Complementary SPST (1 NC, 1 NO)	20-30V ac/dc
STBVR81Q6	5-pin M12 QD			

STB buttons include yellow field cover to prevent unintended switching. To comply to safety standards, STB buttons must be used with appropriate Two-Hand control modules, SC26, XS26 or SC10 Safety Controller or comparable Type IIIC Two-Hand system.

DUO-TOUCH Two-Hand Control Kits with STB Touch Buttons

2 NO Safety Outputs, no auxiliary outputs, 24V ac/dc power supply, meets Cat 4 and Type IIIC



Kit	Module	IP Rating	STB Buttons (2 pieces)	IP Rating	Connection
ATK-VP6	AT-FM-10K	IP20	STBVP6	IP66	2 m cable
ATK-VP6Q5	AT-FM-10K	IP20	STBVP6Q5	IP66	4-pin M12 QD

Kit does not include run bar

Brackets



SMBAMS30P



SMBAMS30RA

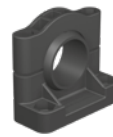

SMB30SC

Enabling Devices

Two Hand Control Run Bars



Run Bars with STBVP6

Model	Connection	E-Stop
STBVP6-RB2	Terminal strip	Not included
STBVP6-RB2Q8	8-pin 7/8 QD	Not included
STBVP6-RB2E02	Terminal strip	SSA-EBM-02L

Telescopic stands for Run Bars



STBA-RB2-S1
■ Floor mounted



STBA-RB2-S2
■ Freestanding

Brackets for Run Bars



STBA-RB2-MB1



STBA-RB2-MB2



STBA-RB2-MB3

Enabling Devices



ED1G Enabling Devices

Model	Contact Configuration	Momentary Push Button
ED1G-L21SM-1N	2 NO & 1 NC Aux	/
ED1G-L21SMB-1N	2 NO & 1 NC Aux	1 NO
ED1G-L20MB-1N	2 NO	2 NO

How to Reach Us

Global Sales and Support

Need additional assistance?

Banner has a network of more than 3,500 factory and field representatives around the world ready to help you. Our highly skilled application engineers and industry experts are ready to support you wherever you are. For a complete listing, go to bannerengineering.com and find your local Banner Representative.

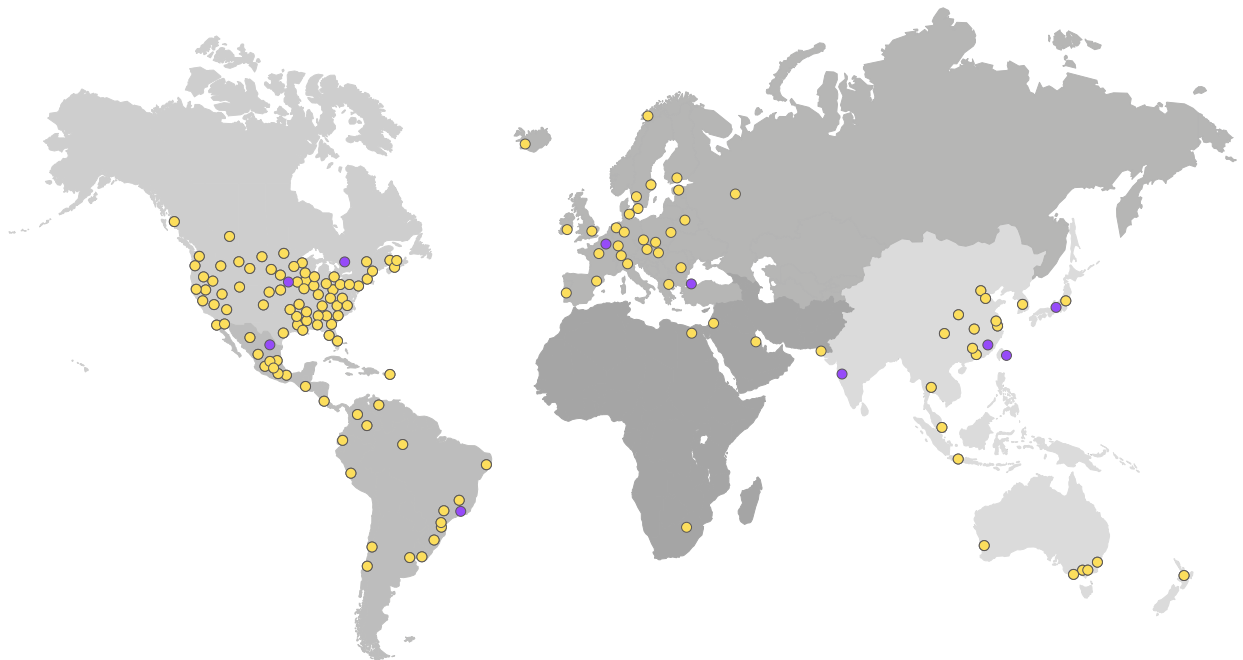

To contact a Banner Engineer about your application, visit our website at www.bannerengineering.com

